

# GRC<sup>®</sup> HD



# 2016

AMORTIGUADORES PARA  
**CAMIONES,  
TRAILERS Y  
AUTOBUSES**



Maneja el espíritu independiente<sup>®</sup>  
[grcautopartes.com.mx](http://grcautopartes.com.mx)

# EXPERIENCIA, COBERTURA Y DURABILIDAD...

## Décadas de experiencia aseguran resultados.

- Las líneas de producto FleetLine® y GasSLX® han sido certificadas dentro y fuera del camino por más de cinco décadas.
- Los Productos GRC® se han probado y mejorado a lo largo del tiempo bajo condiciones de uso reales.
- Los amortiguadores FleetLine® y GasSLX® entregan los resultados que usted espera en cada kilómetro recorrido.

## Cobertura sin igual.

- La cobertura de amortiguadores GRC® para camiones, remolques y autobuses es la más completa del aftermarket.
- La extensa línea de productos FleetLine® y GasSLX® cubren más de 3,000 números de parte de Equipo Original y más de 2,000 números de parte de los competidores de aftermarket.

## GRC® lo tiene todo:

- |  |  |
|--|--|
| <input checked="" type="checkbox"/> Cobertura                        | <input checked="" type="checkbox"/> Aplicaciones extra pesadas |
| <input checked="" type="checkbox"/> Durabilidad                      | <input checked="" type="checkbox"/> Aplicaciones especiales    |
| <input checked="" type="checkbox"/> Barras con súper acabado cromado | <input checked="" type="checkbox"/> Amortiguadores ajustables  |
| <input checked="" type="checkbox"/> Tope hidráulico                  | <input checked="" type="checkbox"/> Aceite de alta temperatura |
| <input checked="" type="checkbox"/> Amortiguadores de cabina         | <input checked="" type="checkbox"/> Célula de gas              |

# ...RESULTADOS COMPROBADOS



## Calidad y Durabilidad - Certificada en condiciones reales, durante millones de kilómetros.



### Tope Hidráulico<sup>1</sup> - GRC® es el autor del diseño exclusivo de tope hidráulico en el amortiguador

- Proporciona de tres a cinco veces más fuerza de absorción que el diseño más robusto de la competencia.<sup>2</sup>
- Mejor sellado.
- Mejora la comodidad y extiende la durabilidad del sistema de control de manejo.
- Reduce significativamente el desgaste en los montajes, faros y otros componentes sensibles a la vibración.



Anillo de acero sólido GRC



Soldadura de arco a 360°

### Montajes Súper Resistentes - Proporcionan una fuerza estructural extraordinaria

- Anillos de acero sólido de una sola pieza con soldadura de arco a 360° grados<sup>4</sup>, en lugar del diseño más común de anillo roldado y soldadura en dos puntos.
- Diseño mejorado para una mayor fuerza de tensión<sup>2</sup>.
- Unión excepcional entre el anillo y la barra.
- Integridad estructural superior; reduce las fallas de los montajes.
- Diseñado para resistir la flexión multidireccional de la suspensión.



### Sello de Pistón Altamente Durable - Auto compensa el desgaste

- Sello de Vitón o hierro fundido<sup>3</sup> que se ajusta para mantener un sellado preciso entre el pistón y el tubo de trabajo.
- A diferencia de los competidores, el diseño de GRC® impide el paso del aceite y proporciona un desempeño constante durante la vida del amortiguador.
- Aumenta la capacidad de control a bajas velocidades.



### Barras con Súper Acabado Cromado - La mejor protección contra la corrosión

- Inhibe la oxidación, minimiza el deterioro.
- Mantiene el pistón libre de suciedad.
- Reduce el desgaste en el sello.
- Aumenta la vida útil del amortiguador.

<sup>1</sup> Cuando se requiere

<sup>2</sup> En pruebas internas GRC

<sup>3</sup> Dependiendo del diseño

<sup>4</sup> Excluyendo la serie 83000

# DISEÑO RESISTENTE PARA LLEVAR A SU FLOTILLA A TRAVÉS DE CUALQUIER CAMINO

Los componentes de calidad, ingeniería de precisión y un diseño durable, garantizan el mejor rendimiento a lo largo de la vida útil de los amortiguadores GRC® para trabajos pesados, y reducen el desgaste de otras partes costosas de la suspensión.

## Cilindro Interior - Extruido en frío (DOM)

- Provee una superficie lisa en el cilindro interior para el desplazamiento del pistón y su sello.
- Menos desgaste y mayor durabilidad.
- Mayor fuerza a la tensión.

## Barras de Pistón Cromadas con Súper Acabado

- Proporciona una mayor resistencia a la corrosión, mejor rendimiento y prolonga la vida del producto.

## Diseño Abocinado \*\*2

- Mayor capacidad de aceite.
- Temperaturas de operación más bajas.
- Menos desgaste interno debido a la disipación de calor.

## Diseño de Sello Durable

- Auto compensa el desgaste a lo largo de la vida del amortiguador.
- Diseño sólido y durable.
- Menos desvanecimiento, un rendimiento más consistente en toda la carrera.
- Reduce las variaciones velocidad-fuerza y aumenta las capacidades de control a bajas velocidades.

## Soldadura de arco a 360° \*

- Mayor resistencia a la tensión.
- Reduce las fallas de los montajes.

## Sello de Aceite de Nitrilo con Labio Triple 2

- La protección adicional del sello mejora la retención del aceite.
- Prolonga la vida útil del amortiguador.

## Tope Hidráulico<sup>1</sup>

- Diseño único y robusto.
- Evita que los amortiguadores lleguen al tope y que las suspensiones se sobre extiendan.
- Reduce significativamente la fatiga en los montajes, faros y otros componentes sensibles a la vibración.

## Valvulaje de 10 etapas

- Para comodidad y control.
- Mayor durabilidad.

## GasSLX® - Ofrece los beneficios indicados anteriormente, más:

- Ajustable en 3 posiciones.
- Célula de gas - separa el gas del aceite.
- Desvanecimiento reducido.
- Aceite de alta temperatura.
- Sello de aceite de Vitón de labios múltiples.

\* Excepto una parte o toda la Serie 83000

\*\* Incluyendo las Series 85300 y 85700

<sup>1</sup> Cuando se requiera.

<sup>2</sup> Excepto GasSLX

Nota: Las características pueden variar según el número de parte.



# GRC® AMORTIGUADORES PARA CAMIONETAS DE TRABAJO PESADO



## FLEETLINE® Y

## GasSLX®



Fleetline® - Amortiguadores para cabinas

### Fleetline® - Amortiguadores para Cabinas

Amortiguadores para trabajo pesado diseñados específicamente para mejorar la comodidad y reducir la vibración en las suspensiones de la cabina.

- Calibres: 1", 1 3/16", 1 3/8" y 1 5/8" para cubrir las suspensiones y diseños de todas las cabinas.



Fleetline® Serie 83000

### Serie 83000

Un producto para trabajo pesado diseñado para vehículos clase 3 - 6 y suspensiones de camiones pesados.

- Calibres de 1 3/8".
- Valvulaje de 10 etapas.
- Sello de pistón con auto compensación para una amortiguación constante a lo largo de la vida útil del amortiguador.



Fleetline® Serie 85000

### Serie 85000

Un producto para trabajos más pesados diseñado para autobuses, camiones y remolques clase 6 - 8.

- Calibre más robusto de 1 5/8" para mayor durabilidad.
- Diseño abocinado\* para mayor capacidad de aceite y una operación más fría.



- El aceite de alta temperatura (H.T.) reduce la fricción y el desgaste en condiciones de operación extremas\* \*.
- Sello de pistón con auto compensación para una amortiguación constante a lo largo de la vida útil del amortiguador.



GasSLX® Serie 89000

### Serie 89000 Ajustable — GasSLX®

Amortiguador de gas, premium, ajustable para vehículos de trabajo pesado, autobuses escolares y de tránsito clase 7 - 8.



- El ajuste en tres posiciones ofrece una selección personal de conducción: regular, firme y extra firme.
- El aceite H.T. especialmente formulado reduce la fricción y el desgaste en condiciones de operación extremas.
- Un diseño único de célula de gas con sellos dobles para una mejor retención del gas.
- Calibre de 1 5/8", montajes con soldadura de arco de 360° con anillos de acero sólido para mayor durabilidad.

\*Serie 85300 y Serie 85700

\*\* Cuando corresponda

# GRC® AMORTIGUADORES PARA CAMIONETAS LIGERAS

## Ultra™ - Amortiguadores y struts para camionetas ligeras

En pocas palabras, Ultra® significa ingeniería de precisión para máxima seguridad y rendimiento con su galardonada tecnología G-Force®.

- Válvulas StableSteer™ - Mejora el contacto del neumático con el camino para mayor seguridad y control.
- Pistón G-Force™ - Construcción de hierro sinterizado para durabilidad y máximo rendimiento del amortiguador.
- Sello de aceite con un labio y diseño EO - Minimiza la fricción para el mejor rendimiento y comodidad.



(Series G63000/G64000)



Struts (Series G52000/G55000/G56000)



Asientos de resorte (Serie G51000)



(Serie 58000)

## Amortiguadores LTV®

- El mejor amortiguador para aplicaciones comerciales pesadas de uso severo.
- Pistón reforzado de 1 5/8" (41 mm) y cabeza de compresión de hierro sinterizado.
- Montajes soldados a 360° para máxima resistencia estructural.

## Amortiguadores Monotubo MaxControl

- Para conducción y control superiores en cualquier camioneta ligera o SUV.
- Calibre más grande de 1 13/16" (46mm) para una reacción más rápida.
- Diseño monotubo y sello de niveles múltiples para reducir la temperatura de la cámara y el ingreso de desechos.
- Gas nitrógeno de alta presión y tecnología de pistón flotante permiten la reacción inmediata del amortiguador.



(Series 75000/77000/79900)

## Amortiguadores de soporte delantero y trasero

- Combinación perfecta entre la tecnología de amortiguación y resorte.
- Los resorte delanteros de ritmo constante ayudan a mejorar la estabilidad, restaurar o mantener la altura de manejo.
- Los resortes traseros de ritmo variable proporcionan una capacidad de carga de 500 libras, por par. **NOTA: No debe exceder el peso vehicular bruto. El producto no aumenta la carga útil.**



(Series 34/43000) Paquete en pares

## Estabilizadores de Dirección

- Mejoran el manejo y control de su vehículo amortiguando las cargas laterales del sistema de dirección.
- Bujes de uretano, aceite de alto rendimiento y esponja celular para resistir la pérdida de amortiguación.
- Aumentan la seguridad de conducción.



(Serie 6800SE)

# GRC® GUÍA PARA INSPECCIÓN DE AMORTIGUADORES



## Reduzca el tiempo muerto con un mantenimiento periódico

Las suspensiones actuales de clase 3 - 8 requieren amortiguadores de alto rendimiento para minimizar el desgaste y proteger los componentes de la suspensión de daños por la vibración, incluyendo los neumáticos. Los amortiguadores desgastados también aumentan la fatiga del conductor ya que no pueden amortiguar la oscilación de la suspensión que se transfiere a la cabina de los sofisticados sistemas de suspensión actuales.

Un programa de inspección y mantenimiento del amortiguador de manera periódica le ayudará a evitar el tiempo muerto y a reducir el desgaste de otros componentes. Entre estas revisiones periódicas, busque señales que estén produciendo un desgaste.

Los indicios de que podría requerirse el mantenimiento y que los amortiguadores deberían revisarse para su reemplazo incluyen:

- Desgaste desigual del neumático
- Deterioro en la conducción
- Vibración excesiva
- Hundimiento de los muelles
- Desgaste prematuro
- Bolsas de aire rotas o desgastadas

## Señales de que es tiempo de reemplazar los amortiguadores



Fugas



Montajes rotos



Bujes desgastados o rotos



Bloqueado o fracturado internamente



Instalación incorrecta



Polvera rota



Falla en los montajes del vehículo



Doblado o golpeado

# INSTRUCCIONES DE DESECHO

## Instrucciones de desecho

Toma las medidas adecuadas de protección, tales como gafas de seguridad y guantes protectores cuando extraiga aceite y gas de los amortiguadores desechados y defectuosos.

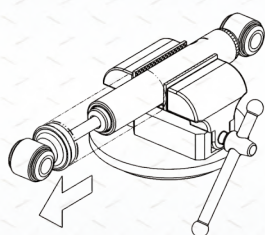

FIG. A

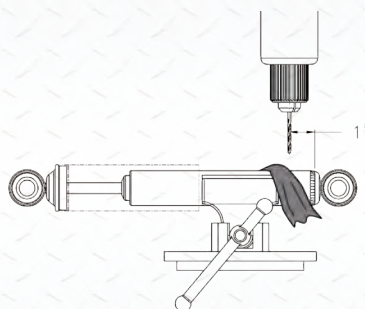

FIG. B

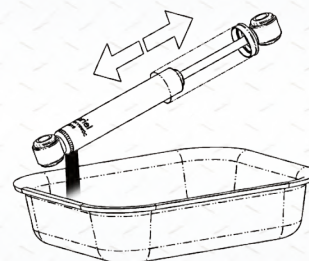

FIG. C

### Procedimiento

1. Asegure el amortiguador en posición horizontal. Extienda completamente la barra del pistón antes de perforar la unidad. (vea la Fig. A).
2. Use una broca de 1/8" (3 mm), taladre un orificio de aproximadamente 1" (25 mm) en la parte inferior del amortiguador a una profundidad de aproximadamente 1" (25mm) (vea la Fig. B).
3. Realice un segundo orificio del lado contrario, para facilitar la salida del aceite.
4. Mueva la barra del pistón hacia adentro y hacia afuera, agite el amortiguador para asegurar que salga todo el aceite.

### Información ambiental

5. Recoja todo el aceite usado, teniendo cuidado de no mezclarlo con cualquier otro desecho o residuo. Almacene el aceite usado en un recipiente aprobado y marcado claramente como "aceite usado".
6. Deseche el amortiguador y las piezas internas de acuerdo con sus leyes locales o estatales sobre aceites o refacciones usadas, y otros desechos.
7. Almacene, deseche y/o transporte el aceite usado de acuerdo con las normas ambientales vigentes.

El aceite del amortiguador puede desecharse en el recipiente utilizado para reciclar los aceites de motor. La información sobre dónde desechar el aceite y otras partes se puede obtener de las autoridades ambientales o proveedores de aceites.



# ÍNDICE

## ¿POR QUE GRC®?

NUEVOS NÚMEROS DE PARTE / NÚMEROS DE PARTE REEMPLAZADOS .....	2
---	---

## LISTAS DE APLICACIONES Y POR NÚMEROS DE PARTE

FLEETLINE AMORTIGUADORES - PARA CABINAS Y APLICACIONES ESPECIALES .....	3
---	---

CAMIONETAS - LISTA DE APLICACIONES .....	6
--	---

CAMIONETAS - LISTA POR NÚMEROS DE PARTE .....	90
---	----

CAMIONES PESADOS Y MEDIANOS, SEMIRREMOLQUES Y AUTOBUSES - LISTA DE APLICACIONES .....	141
---	-----

CAMIONES PESADOS Y MEDIANOS, SEMIRREMOLQUES Y AUTOBUSES - LISTA POR NÚMEROS DE PARTE .....	322
--	-----

INTERCAMBIOS FLEETLINE / GASSLX .....	334
---------------------------------------	-----

INTERCAMBIOS CONTRA COMPETIDORES Y EQUIPO ORIGINAL .....	335
--	-----

CÓMO ESCOGER EL MEJOR AMORTIGUADOR PARA SU CAMIÓN .....	378
---	-----

ESPECIFICACIONES POR NÚMERO DE PARTE .....	385
--	-----

ESPECIFICACIONES POR TIPO DE MONTAJE .....	447
--	-----

KITS DE ACCESORIOS Y COMPONENTES .....	509
--	-----

KITS DE ACCESORIOS – GUÍA DEL COMPRADOR .....	518
---	-----

## NUEVOS NÚMEROS DE PARTE

83065*	83505	83512*	85119*	85993*	143359
83066*	83506	83513*	85120*	85994*	143383
83175	83507	83514*	85121*	85995*	143385
83176	83508	83515*	85122*	85996*	143389
83177	83509	85109	85123*	85997*	143424
83178	83510	85117*	85745*	85998*	G64131
83179	83511	85118*	85746*	85999*	

\*NÚMERO DE PARTE FUTURO

## LISTA DE REEMPLAZOS DE 9 AÑOS

EN CATÁLOGO	ELIMINAR	AHORA USAR	EN CATÁLOGO	ELIMINAR	AHORA USAR
2010	632155	646155 o 646177	2007	85328	83136
2006	83106	83136	2006	85922	85920
2007	83132	83140	2006	87001	85734
2005	85044	85058	2006	87002	85736
2007	85048	83136	2006	87004	85735
2006	85049	85071	2006	87006	85736
2007	85057	85907			
2007	85325	83136			
2006	85326	85336			

## GUÍA DE APLICACIONES ESPECIALES

Año	Modelo	# E.O.	Fleetline #
<b>ADVANCE MIXER</b>			
	Mezcladoras con Descarga Trasera con Amortiguadores de Eje con Auto Dirección	12111 ADV	646155
<b>CHALLENGE</b>			
	Mezcladora de Cemento	632147 632155	632147 646177
<b>GRANNING SUSPENSION</b>			
	Eje con Auto Dirección Modelo L120	701071-01	646155
<b>HENDRICKSON TRAILER SUSPENSION SYSTEMS</b>			
<b>Sistema de Dirección Auxiliar de Levantamiento (HL)</b>			
	HLP Paralift	A-14496	646155
	HLU Paralift Ultra	A-14496	646155
<b>INGERSALL MACHINE</b>			
	Eje Modelo 700060-0	665472	665472
	Modelos con Número de E.O.	665904	665472
<b>KIMBLE MIXER CO</b>			
	Mezcladoras con Descarga Trasera con Amortiguadores de Eje con Auto Dirección	OE10455	646155
<b>LINK/HIGH-STEER</b>			
	Estabilizador de Dirección Modelos 6000	632155	646177
	Estabilizador de Dirección Modelos 9000	1210-0007 1210-0009	665937 665937
	Modelos con Número de E.O.	1210-0001 1210-0002 1210-0010 1210-0012 646168	646155 632147 646155 646155 646155
<b>LONDON MIXER</b>			
	Mezcladoras con Descarga Trasera con Amortiguadores de Eje con Auto Dirección	MB-37737-30	646155
<b>MC NEILUS TRUCK &amp; MAN.</b>			
	Ejes Tarjeta	1170719 600-115994B 600-115994B	632147 632147 632147
	Modelos con Número de E.O.	2034140 MTM 600-11599M	646155 632147
	Modelos V Bridgemaster con Amortiguadores de Eje con Auto Dirección	600-188206	646155
<b>MILITARY</b>			
	Camiones 6 X 6 con Número de E.O.	680781 7409617	85308 85308
<b>OSHKOSH MOTORS</b>			
	Modelos con Número de E.O.	2034140	646177
<b>PIERCE MANUFACTURING INC.</b>			
	Modelos con Número de E.O.	2034140	646177
<b>REX MIXER</b>			
	Mezcladoras con Descarga Trasera con Amortiguadores de Eje con Auto Dirección	102-13441-10	646155
<b>REYCO SUSPENSION</b>			
	Estabilizador de Dirección Modelos L132	701071-01	665937
<b>RIDEWELL CORPORATION</b>			
	RLT-230	1310002	665937
	RSS-232	1317570B001	646155
	RSS-236/R	1310002 1310004	665937 665937
<b>SAF HOLLAND</b>			
	Amortiguadores de Eje con Auto Dirección	90045331	646155

**GUÍA DE APLICACIONES ESPECIALES**

Año	Modelo	# E.O.	Fleetline #
-----	--------	--------	-------------

**SAF HOLLAND (Cont.)**

**Neway V-Steer II (Cont.)**

	Amortiguadores de Eje con Auto Dirección	632155	646177
--	--	--------	--------

**SPRING VALLEY**

	Estabilizador de Dirección Modelos SS120	632155	646177
	Estabilizador de Dirección Modelos SS130L	632155	646177

**SUSPENSIONS INC.**

	Eje Levantado con Dirección Modelos LP11	200188	646155
--	--	--------	--------

**TEREX CORPORATION**

	Mezcladoras con Descarga Trasera con Amortiguadores de Eje con Auto Dirección	12111	646155
--	---	-------	--------

**TUTHILL TECHNOLOGIES**

	Modelos con Número de E.O.	66502	646155
--	----------------------------	-------	--------

**VARIOS**

**Estabilizador de Dirección**

	Camiones Clase 8 con Eje Delantero de 10,000 lb a 20,000 lb	SC-2920	83176
--	---	---------	-------

**WATSON & CHALIN MFG. INC.**

**Sistemas de Suspensión de Eje con Auto Dirección**

	LW5L-1100 SR	11418	646155
	Modelos con Número de E.O.	17069	632147
	Suspensión Eje Levantado con Dirección Modelos SL-2089	11418	646155
	WCAL-1000 SST	11418	646155
	WCAL-1100 LR	11418	646155
	WCAL-1100 SR	11418	646155
	WCAL-1100 SRLP	11418	646155
	WCAL-1100 SSR	11418	646155
	WCHL-1100 FL	11418	646155
	WCHL-1100 HI-LIFT	11418	646155

**WESTPORT AXLE CORP**

	Sistemas de Suspensión de Eje con Auto Dirección	143699-0185 646124	646177 646177
--	--	-----------------------	------------------





# Amortiguadores Para Camionetas

(Lista alfabética)  
(Lista numérica)

**GRC**<sup>®</sup>  
AUTOPARTES

Maneja el espíritu independiente™























# AMORTIGUADORES Y STRUTS

Año	Notas de Aplicación										
		Ultra	ProGuard\ Guardian	Max Control\ LTV	Protector de Strut\ Bases de Strut	HiJacker\ Soporte\ Hidráulico	Ultra	ProGuard\ Guardian	Max Control\ LTV	Protector de Strut\ Bases de Strut	HiJacker\ Soporte\ Hidráulico

## CADILLAC

## CADILLAC













### COMMERCIAL CHASSIS

92-96	RWD		69675 <sup>5</sup>	81446	....	....	34073 <sup>8</sup>		69724	81514	....	....	43049 <sup>8</sup> 49131 <sup>30</sup>
91-93	FWD		G56718 <sup>9</sup>	....	....	142225 <sup>54</sup> 142227 <sup>58</sup> 142751 <sup>65</sup> 143060 <sup>51</sup>	....		....	....	....	143060 <sup>51</sup>	....
	FWD; Reemplazo Convencional para Suspensión Trasera Asistida; Exc. Suspensión Electrónica		....	....	....	....	....		G56707 <sup>9</sup>	....	....	....	....
	FWD; Suspensión Trasera Asistida; Exc. Suspensión Electrónica Ajustable		....	....	....	....	....		G56903	....	....	....	142132 <sup>53</sup>
85-90	Todos		G56701	....	....	142225 <sup>54</sup> 142752 <sup>65</sup> 143061 <sup>51</sup>	....		....	....	....	....	....
	Equipamiento Estándar para Suspensión Trasera Asistida por Aire		G56701	....	....	142225 <sup>54</sup> 142752 <sup>65</sup> 143061 <sup>51</sup>	....		....	....	....	....	142132 <sup>53</sup>
	FWD		G56701	....	....	142227 <sup>58</sup> 142225 <sup>54</sup> 142752 <sup>65</sup> 143061 <sup>51</sup>	....		....	....	....	....	143060 <sup>51</sup>
	FWD; Equipamiento Estándar para Suspensión Trasera Asistida por Aire		G56701	....	....	142225 <sup>54</sup> 142752 <sup>65</sup> 143061 <sup>51</sup>	....		G56903	....	....	....	....
	FWD; Reemplazo Convencional para Suspensión Trasera Asistida; Exc. Suspensión Electrónica		G56701	....	....	142225 <sup>54</sup> 142752 <sup>65</sup> 143061 <sup>51</sup>	....		G56707 <sup>9</sup>	....	....	....	....
77-84	Todos		69675 <sup>5</sup>	81446	....	....	34073 <sup>8</sup>		69724	81514	....	....	43049 <sup>8</sup> 49131 <sup>30</sup>
75-76	Todos		....	82601	....	....	....		....	82125	....	....	....







### COMMERCIAL CHASSIS ESTABILIZADORES DE DIRECCIÓN

		Delantero		Trasero	
92-96	RWD	14019		....	
77-84	Todos	14019		....	



### ESCALADE

11-13	Todos		....	....	....	....	....		G63866	....	....	....	....
	Exc. Control de Manejo Electrónico		....	....	....	143316 <sup>53</sup>	....		G63866	....	....	....	....
07-10	Exc. Control de Manejo Electrónico		....	....	....	143316 <sup>53</sup>	....		G63866	61675	58930 77953	....	....
02-10	Todos		....	....	....	....	....		G63866	....	58930 77953	....	....
02-06	Exc. Control de Manejo Electrónico		....	....	....	....	....		G63866	61675	58930 77953	....	....
99-00	Todos		G63609	61542 81726	58609 77609	....	....		G63638	61565 81789	58638 77638	....	43180 <sup>8</sup> 49231 <sup>7</sup>

### ESCALADE ESV

11-13	Exc. Control de Manejo Electrónico		....	....	....	143316 <sup>53</sup>	....		....	....	....	....	....
07-10	Exc. Control de Manejo Electrónico		....	....	....	143316 <sup>53</sup>	....		....	61675	....	....	....
03-06	Exc. Control de Manejo Electrónico		....	....	....	....	....		....	61675	....	....	....

### ESCALADE EXT

11-13	Exc. Control de Manejo Electrónico		....	....	....	143316 <sup>53</sup>	....		....	....	....	....	....
-------	------------------------------------	---	------	------	------	----------------------	------	---	------	------	------	------	------

5 Use el kit 140719 para reemplazar partes del EO de montaje inferior cuando los pernos se rompan o los tornillos autoroscantes no se puedan utilizar más.

8 Paquetes en pares

30 Para Vehículos GM equipados con sistemas de nivelación de fábrica, vea Ref. A.

53 Montaje de Strut. Es probable reutilizar algunas partes del E.O.

58 El Kit de Montaje incluye: Rodamiento de Suspensión. Es probable reutilizar algunas partes del E.O.

7 Paquetes en pares; kit de mangueras de aire incluido





9 Vea Ref.D para los procedimientos de reemplazo de una Susp. Elect. Ajust. con un producto no ajust.

51 Protectores de Strut.

54 Kit con Montaje y Rodamiento. Es probable que reutilizar algunas partes del E.O.

65 El Kit de Montaje incluye: Asiento de Resorte Superior con Aislador. Es probable reutilizar algunas partes del E.O.





# AMORTIGUADORES Y STRUTS

Año	Notas de Aplicación										
			Ultra	ProGuard\ Guardian	Max Control\ LTV	Protector de Strut\ Bases de Strut	HiJacker\ Soporte\ Hidráulico		Ultra	ProGuard\ Guardian	Max Control\ LTV

## CADILLAC

## CADILLAC









### ESCALADE EXT (cont)

07-10	Exc. Control de Manejo Electrónico		....	....	....	143316 <sup>53</sup>	....		....	61675	....	....	....
02-06	Exc. Control de Manejo Electrónico		....	....	....	....	....		....	61675	....	....	....









## CHEVROLET

## CHEVROLET



### ASTRO

90-05	Todos		....	....	....	....	....		G63454	61539 81581	77454	....	43161 <sup>8</sup> 49215 <sup>7</sup>
	AWD		G63818	61542 81726	58609 77609	....	....		G63454	61539 81581	77454	....	43161 <sup>8</sup> 49215 <sup>7</sup>
	RWD		G63375 <sup>5</sup>	61555 81713 <sup>5</sup>	77375	....	....		G63454	61539 81581	77454	....	43161 <sup>8</sup> 49215 <sup>7</sup>
85-89	RWD		G63375 <sup>5</sup>	61555 81713 <sup>5</sup>	77375	....	....		G63454	61539 81581	77454	....	43161 <sup>8</sup> 49215 <sup>7</sup>



### AVALANCHE 1500

12-13	Exc. Suspensión Z55 o ZW7		G51891	....	....	....	....		....	....	....	....	....
07-13	Exc. Control de Manejo Electrónico		....	....	....	143316 <sup>53</sup>	....		....	....	....	....	....
07-11	Exc. Suspensión Z55 o ZW7		G51891	....	....	....	....		G63866	61675 81930	58930 77953	....	....
02-06	Exc. Control de Manejo Electrónico		G63803	61643 81922	58803 77803	....	....		G63866	61675 81930	58930 77953	....	....



















### AVALANCHE 2500

02-06	Exc. Control de Manejo Electrónico		G63817	61663 81925	58817 77817	....	....		G63866	61675 81930	58930 77953	....	....
-------	------------------------------------	---	--------	----------------	----------------	------	------	---	--------	----------------	----------------	------	------









### BLAZER

73-91	Todos		....	....	....	....	....		....	....	....	....	70165
-------	-------	---	------	------	------	------	------	---	------	------	------	------	-------

### BLAZER 2WD

95-05	RWD; Modelos S, Exc. Xtreme Models		G63421	61504 81750	58421 77421	....	34051 <sup>8</sup>		G63422	61528 81482	58422 77422	....	43162 <sup>8</sup> 49213 <sup>7</sup>
87-91	Automóvil Grande; Exc. Suspensión Quad y Kit de Levantamiento		....	....	....	....	....		G63349	61524 81164	58349 <sup>50</sup> 77349	....	43111 <sup>8</sup> 49155 <sup>7</sup>
73-86	Exc. Kit de Levantamiento		....	....	....	....	....		G63349	61524 81164	58349 77349	....	43111 <sup>8</sup> 49155 <sup>7</sup>
73-84	RWD		G63355	61525 81039	58355 77355	....	34036 <sup>8</sup>		....	....	....	....	....
69-72	Resorte Trasero		....	....	....	....	....		....	82003	....	....	49107 <sup>7</sup>
	Resorte Trasero de Hojas Múltiples		....	....	....	....	....		....	82006	....	....	49162 <sup>7</sup>
	RWD; Resorte Trasero		....	....	....	....	....		....	....	....	....	43062 <sup>8</sup>
	RWD; Resorte Trasero de Hojas Múltiples		....	....	....	....	....		....	....	....	....	43093 <sup>8</sup>
	RWD		G63355	61525 81039	58355 77355	....	34036 <sup>8</sup>		G63306	....	....	....	....

### BLAZER 4WD

95-05	4WD; Modelos S; Exc. ZR2		G63423	61531 81516	58423 77423	....	....		G63422	61528 81482	58422 77422	....	43162 <sup>8</sup> 49213 <sup>7</sup>
92-94	4WD, Automóvil Grande		G63609	61542 81726	58609 77609	....	....		G63638 <sup>50</sup>	61565 81789	58638 77638	....	43180 <sup>8</sup> 49231 <sup>7</sup>
87-91	Automóvil Grande; Exc. Suspensión Quad y Kit de Levantamiento		....	....	....	....	....		G63349	61524 81164	58349 <sup>50</sup> 77349	....	43111 <sup>8</sup> 49155 <sup>7</sup>
	4WD, Automóvil Grande; Exc. Suspensión Quad y Kit de Levantamiento		G63347	....	58347 <sup>50</sup>	....	43107 <sup>8</sup>		....	....	....	....	....

5 Use el kit 140719 para reemplazar partes del EO de montaje inferior cuando los pernos se rompan o los tornillos autoroscantes no se puedan utilizar más.





7 Paquetes en pares; kit de mangueras de aire incluido

50 Para proteger la barra del pistón, se recomienda utilizar el kit Bellows No.141242.

8 Paquetes en pares

53 Montaje de Strut. Es probable reutilizar algunas partes del E.O.

































# AMORTIGUADORES Y STRUTS

Año	Notas de Aplicación										
			Ultra	ProGuard\ Guardian	Max Control\ LTV	Protector de Strut\ Bases de Strut	HiJacker\ Soporte\ Hidráulico		Ultra	ProGuard\ Guardian	Max Control\ LTV

## CHEVROLET

## CHEVROLET

### BLAZER 4WD (cont)

87-91	4WD, Automóvil Grande; Suspensión Quad Amortiguador Corto; Exc. Kit de Levantamiento		G63908 <sup>6</sup>	61516 <sup>6</sup> 81113 <sup>6</sup>	58908 <sup>6</sup>	....	....		....	....	....	....
	4WD, Automóvil Grande; Suspensión Quad Amortiguador Largo; Exc. Kit de Levantamiento		G63906 <sup>6</sup>	61522 <sup>6</sup> 81496 <sup>6</sup>	58906 <sup>6</sup>	....	....		....	....	....	....
91	4WD, Automóvil Grande; Kit de Levantamiento de 4"; Exc. Suspensión Quad		G63437 <sup>50</sup>	....	58437 <sup>50</sup>	....	....		....	....	....	....
87-90	4WD, Automóvil Grande; Kit de Levantamiento de 4"; Exc. Suspensión Quad		G63437 <sup>50</sup>	....	58437 <sup>50</sup>	....	....		G63438 <sup>50</sup>	....	58438 <sup>50</sup>	....
81-86	4WD, Exc. Suspensión Quad y Kit de Levantamiento		G63347	....	58347 <sup>50</sup>	....	43107 <sup>8</sup>		....	....	....	....
	4WD, Suspensión Quad Amortiguador Corto; Exc. Kit de Levantamiento		G63908 <sup>6</sup>	61516 81113 <sup>6</sup>	58908 <sup>6</sup>	....	....		....	....	....	....
	4WD, Suspensión Quad Amortiguador Largo; Exc. Kit de Levantamiento		G63906 <sup>6</sup>	61522 <sup>6</sup> 81496 <sup>6</sup>	58906 <sup>6</sup>	....	....		....	....	....	....
73-86	Exc. Kit de Levantamiento		....	....	....	....	....		G63349	61524 81164	58349 77349	.... 43111 <sup>8</sup> 49155 <sup>7</sup>
	4WD, Con Kit de Levantamiento de 4"; Exc. Suspensión Quad		G63437 <sup>50</sup>	....	58437 <sup>50</sup>	....	....		G63438 <sup>50</sup>	....	58438 <sup>50</sup>	....
75-80	4WD, Exc. Suspensión Quad y Kit de Levantamiento		G63347	61516 81113	58347 <sup>50</sup>	....	43107 <sup>8</sup>		....	....	....	....
73-74	4WD, Exc. Kit de Levantamiento		G63347	61516 81113	58347	....	43107 <sup>8</sup>		....	....	....	....
69-72	Resorte Trasero		....	....	....	....	....		....	82003	....	49107 <sup>7</sup>
	Resorte Trasero de Hojas Múltiples		....	....	....	....	....		....	82006	....	49162 <sup>7</sup>
	RWD; Resorte Trasero		....	....	....	....	....		....	....	....	43062 <sup>8</sup>
	RWD; Resorte Trasero de Hojas Múltiples		....	....	....	....	....		....	....	....	43093 <sup>8</sup>
	4WD		G63347	61516 81113	58347	....	43107 <sup>8</sup>		G63371	....	....	....









### BLAZER ESTABILIZADORES DE DIRECCIÓN 2WD

		Delantero	Trasero
81-84	RWD, Sistema Sencillo sin EO	6849SE <sup>82</sup>	....
79-84	RWD, Estabilizador de Dirección Sistema Dual	6802SE <sup>84</sup>	....
75-84	RWD	14017	....
	RWD, Estabilizador de Dirección Sistema Sencillo	6804SE <sup>80</sup>	....
69-72	Estabilizador de Dirección Sistema Sencillo	6803SE <sup>84</sup>	....

### BLAZER ESTABILIZADORES DE DIRECCIÓN 4WD

		Delantero	Trasero
87-91	4WD, Full Size	14017	....
84-86	4WD, Estabilizador de Dirección Sistema Sencillo; sin orificio de montaje de EO en brazo de dirección	6851SE <sup>82</sup>	....
79-86	4WD, Estabilizador de Dirección Sistema Dual	6802SE <sup>84</sup>	....
75-86	4WD	14017	....
	4WD, Estabilizador de Dirección Sistema Sencillo	6804SE <sup>80</sup>	....
69-72	Estabilizador de Dirección Sistema Sencillo	6803SE <sup>84</sup>	....

### BLAZER, S MODELS

83-05	Todos		....	....	....	....		....	....	....	....	70173
	RWD		....	....	....	....	70171		....	....	....	70173
90-94	RWD 3.1L 2BBL		....	....	....	....	42969		....	....	....	42968 70173
88-94	4WD, Barra de Torsion(FrontSpringType)		....	....	....	142316 <sup>53</sup>	....		....	....	....	70173

6 Se recomienda que cuando se reemplacen amortiguadores "quad", los 4 sean de la misma serie.

8 Paquetes en pares

53 Montaje de Strut. Es probable reutilizar algunas partes del E.O.

82 Use kit si está señalado. Vea Ref. C para Botas.

7 Paquetes en pares; kit de mangueras de aire incluido





50 Para proteger la barra del pistón, se recomienda utilizar el kit Bellows No.141242.

80 No requiere soportes para el montaje, instalar sobre montajes de EO Vea Ref. C para Botas.

84 Amortiguador de repuesto para los vehículos con el kit de montaje aftermarket GRC









# AMORTIGUADORES Y STRUTS

Año	Notas de Aplicación										
			Ultra	ProGuard\ Guardian	Max Control\ LTV	Protector de Strut\ Bases de Strut	HiJacker\ Soporte\ Hidráulico		Ultra	ProGuard\ Guardian	Max Control\ LTV

## CHEVROLET

## CHEVROLET



### BLAZER, S MODELS (cont)

83-94	Todos		....	....	....	....	....		G63422	61528 81482	58422 77422	....	....	43162 <sup>8</sup> 49213 <sup>7</sup> 70173
	4WD		G63423	61531 81516	58423 77423	....	....		....	....	....	....	....	70173
	RWD		G63421	61504 81750	58421 77421	....	....	34051 <sup>8</sup>		....	....	....	....	70173

### BLAZER, S MODELS ESTABILIZADORES DE DIRECCIÓN

										Delantero	Trasero
83-94	Estabilizador de Dirección Sistema Sencillo; con orificio de montaje de EO en brazo de dirección									6801SE	....











### C25

73-91	Todos		....	....	....	....	70164		....	....	....	....	....	70165
-------	-------	---	------	------	------	------	-------	---	------	------	------	------	------	-------







### C35

73-91	Todos		....	....	....	....	70164		....	....	....	....	....	....
-------	-------	---	------	------	------	------	-------	---	------	------	------	------	------	------

















### CHEYENNE

14	Todos		G51949	....	....	....	....		....	....	....	....	....	....
	Exc. Suspensión Electrónica Ajustable		G51949	....	....	....	....		G63959	61690	....	....	....	....
07-13	Exc. Suspensión Electrónica Ajustable		G51870	....	....	....	....		G63959	61690	....	....	....	....
03-07	4WD; Exc. Suspensión Electrónica Ajustable		G63803	....	58803 77803	....	....		G63675	....	58412 77412	....	....	....
	RWD; Exc. Suspensión Electrónica Ajustable		G63783	....	58783 77783	....	....		G63662	....	58662 77662	....	....	43181

### COLORADO

09-11	Barra de Torsion(FrontSpringType)		....	....	....	....	....		G63879	....	....	....	....	....
04-11	RWD, Coil(FrontSpringType) Exc. Paquete Z71 Off Road		G51850	....	....	....	....		G63882	....	....	....	....	....
04-08	Barra de Torsion(FrontSpringType)		G63884	....	....	....	....		G63879	....	....	....	....	....

### IMPALA

11	Todos		G55948	....	....	142524 <sup>58</sup> 142526 <sup>54</sup> 143060 <sup>51</sup>	....		....	....	....	....	143061 <sup>51</sup>	....	
	Exc. Modelos c/ Ruedas de 17" o 18"		G55948	....	....	142524 <sup>58</sup> 142526 <sup>54</sup> 143060 <sup>51</sup>	....		G55949	....	....	....	143061 <sup>51</sup>	....	
	Izquierdo		G55948	....	....	142524 <sup>58</sup> 142526 <sup>54</sup> 143060 <sup>51</sup>	....		....	....	....	....	143073 <sup>53</sup> 143061 <sup>51</sup>	....	
	Modelos con Llantas de 17" o 18"		G55948	....	....	142524 <sup>58</sup> 142526 <sup>54</sup> 143060 <sup>51</sup>	....		G52244	....	....	....	....	143061 <sup>51</sup>	....
	Derecho		G55948	....	....	142524 <sup>58</sup> 142526 <sup>54</sup> 143060 <sup>51</sup>	....		....	....	....	....	....	143074 <sup>53</sup> 143061 <sup>51</sup>	....
04-10	Modelos con Llantas de 17" o 18"		G55948	....	....	142524 <sup>58</sup> 142525 142526 <sup>54</sup> 143060 <sup>51</sup>	....		G52244	....	....	....	....	143061 <sup>51</sup>	....
00-10	Todos		G55948	....	....	142524 <sup>58</sup> 142525 142526 <sup>54</sup> 143060 <sup>51</sup>	....		....	....	....	....	....	143061 <sup>51</sup>	....
	Exc. Modelos c/ Ruedas de 17" o 18"		G55948	....	....	142524 <sup>58</sup> 142525 142526 <sup>54</sup> 143060 <sup>51</sup>	....		G55949	....	....	....	....	143061 <sup>51</sup>	....

7 Paquetes en pares; kit de mangueras de aire incluido

51 Protectores de Strut.



54 Kit con Montaje y Rodamiento. Es probable que reutilizar algunas partes del E.O.

8 Paquetes en pares

53 Montaje de Strut. Es probable reutilizar algunas partes del E.O.

58 El Kit de Montaje incluye: Rodamiento de Suspensión. Es probable reutilizar algunas partes del E.O.





























































# AMORTIGUADORES Y STRUTS

Año	Notas de Aplicación										
		Ultra	ProGuard\ Guardian	Max Control\ LTV	Protector de Strut\ Bases de Strut	HiJacker\ Soporte\ Hidráulico	Ultra	ProGuard\ Guardian	Max Control\ LTV	Protector de Strut\ Bases de Strut	HiJacker\ Soporte\ Hidráulico



## CHEVROLET

### IMPALA (cont)

## CHEVROLET

00-10	Izquierdo		G55948	....	....	142524 <sup>58</sup> 142525 142526 <sup>54</sup> 143060 <sup>51</sup>	....		....	....	....	143073 <sup>53</sup> 143061 <sup>51</sup>	....
	Derecho		G55948	....	....	142524 <sup>58</sup> 142525 142526 <sup>54</sup> 143060 <sup>51</sup>	....		....	....	....	143074 <sup>53</sup> 143061 <sup>51</sup>	....
94-96	Todos		69675 <sup>5</sup>	....	....	....	34073 <sup>8</sup>		69724	81514	....	....	43049 <sup>8</sup> 49131 <sup>30</sup>
	Exc. Modelos Policía y Taxi		69675 <sup>5</sup>	81446	....	....	34073 <sup>8</sup>		69724	81514	....	....	43049 <sup>8</sup> 49131 <sup>30</sup>
83-85	Todos		69675 <sup>5</sup>	....	....	....	34073 <sup>8</sup>		69724	81514	....	....	43049 <sup>8</sup> 49131 <sup>30</sup>
	Exc. Modelos Policía y Taxi		69675 <sup>5</sup>	81446	....	....	34073 <sup>8</sup>		69724	81514	....	....	43049 <sup>8</sup> 49131 <sup>30</sup>
	Modelos Policía y Taxi		G63375 <sup>5</sup>	61555 81713 <sup>5</sup>	....	....	34073 <sup>8</sup>		69724	81514	....	....	43049 <sup>8</sup> 49131 <sup>30</sup>
	Sedan Modelos Policía y Taxi		69675 <sup>5</sup>	....	77375	....	34073 <sup>8</sup>		69724	81514	....	....	43049 <sup>8</sup> 49131 <sup>30</sup>
82	Exc. Modelos Policía y Taxi		....	81446	....	....	....		....	....	....	....	....
	Exc. Wagon		....	....	....	....	....		69724	81514	....	....	43049 <sup>8</sup> 49131 <sup>30</sup>
	Sedan		69675 <sup>5</sup>	....	....	....	34073 <sup>8</sup>		....	....	....	....	....
	Sedan Modelos Policía y Taxi		G63375 <sup>5</sup>	61555 81713 <sup>5</sup>	77375	....	....		....	....	....	....	....
	Wagon		....	....	....	....	....		69604	81492	....	....	43060 <sup>8</sup> 49152 <sup>30</sup>
71-81	Todos		69675 <sup>5</sup>	....	....	....	34073 <sup>8</sup>		....	....	....	....	....
	Exc. Modelos Policía y Taxi		69675 <sup>5</sup>	81446	....	....	34073 <sup>8</sup>		....	....	....	....	....
	Sedan Modelos Policía y Taxi		G63375 <sup>5</sup>	61555 81713 <sup>5</sup>	77375	....	34073 <sup>8</sup>		....	....	....	....	....
	Wagon		69675 <sup>5</sup>	....	....	....	34073 <sup>8</sup>		69604	81492	....	....	43060 <sup>8</sup> 49152 <sup>30</sup>
65-81	Exc. Wagon		69675 <sup>5</sup>	....	....	....	34073 <sup>8</sup>		69724	81514	....	....	43049 <sup>8</sup> 49131 <sup>30</sup>
76	4.1L 4BBL		69675 <sup>5</sup>	....	....	....	42446 34073 <sup>8</sup>		....	....	....	....	42514
75	4.1L 4BBL		69675 <sup>5</sup>	....	....	....	42446 34073 <sup>8</sup>		....	....	....	....	....
72	4.8L FI		69675 <sup>5</sup>	....	....	....	42446 34073 <sup>8</sup>		....	....	....	....	42514
71	4.8L DOHC, SFI		69675 <sup>5</sup>	....	....	....	42446 34073 <sup>8</sup>		....	....	....	....	42514
70	Todos		69675 <sup>5</sup>	....	....	....	34073 <sup>8</sup>		69724	....	....	....	....
	Exc. Modelos Policía y Taxi		69675 <sup>5</sup>	81446	....	....	34073 <sup>8</sup>		69724	....	....	....	....
	4.8L DOHC, SFI		69675 <sup>5</sup>	....	....	....	42446 34073 <sup>8</sup>		69724	....	....	....	42514
65-69	Todos		69675 <sup>5</sup>	....	....	....	34073 <sup>8</sup>		69724	....	....	....	49131 <sup>30</sup>
	Exc. Modelos Policía y Taxi		69675 <sup>5</sup>	81446	....	....	34073 <sup>8</sup>		69724	....	....	....	49131 <sup>30</sup>
	4.8L DOHC, SFI		69675 <sup>5</sup>	....	....	....	42446 34073 <sup>8</sup>		69724	....	....	....	42514 49131 <sup>30</sup>
65	4.1L 4BBL		69675 <sup>5</sup>	....	....	....	42446 34073 <sup>8</sup>		69724	....	....	....	42514 49131 <sup>30</sup>
59-64	Todos		....	82118	....	....	....		....	82051	....	....	....

### PICKUP 1/2 TON, C10

87-91	Todos		....	....	....	....	70164		....	....	....	....	....
-------	-------	---	------	------	------	------	-------	---	------	------	------	------	------

5 Use el kit 140719 para reemplazar partes del EO de montaje inferior cuando los pernos se rompan o los tornillos autoroscantes no se puedan utilizar más.

30 Para Vehículos GM equipados con sistemas de nivelación de fábrica, vea Ref. A.

53 Montaje de Strut. Es probable reutilizar algunas partes del E.O.





58 El Kit de Montaje incluye: Rodamiento de Suspensión. Es probable reutilizar algunas partes del E.O.

8 Paquetes en pares

51 Protectores de Strut.

54 Kit con Montaje y Rodamiento. Es probable que reutilizar algunas partes del E.O.

















# AMORTIGUADORES Y STRUTS

Año	Notas de Aplicación										
			Ultra	ProGuard/ Guardian	Max Control/ LTV	Protector de Strut/ Bases de Strut	HiJacker/ Soporte/ Hidráulico		Ultra	ProGuard/ Guardian	Max Control/ LTV

## CHEVROLET

## CHEVROLET







### PICKUP 1/2 TON, C10 (cont)

87	5.7L MFI		....	....	....	....	42961 70164		....	....	....	....	42958
79-86	Todos		G63355	61525 81039	58355 77355	....	34036 <sup>8</sup> 42961 70164		G63349	61524 81164	58349 77349	....	42958 43111 <sup>8</sup> 49155 <sup>7</sup>
75-78	Todos		G63355	61525 81039	58355 77355	....	34036 <sup>8</sup>		G63349	61524 81164	58349 77349	....	43111 <sup>8</sup> 49155 <sup>7</sup>
73-74	Todos		G63355	61525 81039	58355 77355	....	34036 <sup>8</sup> 70164		....	61524 81164	58349 77349	....	43111 <sup>8</sup> 49155 <sup>7</sup>
67-72	Resorte Trasero		G63355	61525 81039	58355 77355	....	34036 <sup>8</sup> 70164		....	82003	....	....	43062 <sup>9</sup> 49107 <sup>7</sup>
63-72	Todos		G63355	61525 81039	58355 77355	....	34036 <sup>8</sup> 70164		....	....	....	....	....
	Resorte Trasero de Hojas Múltiples		G63355	61525 81039	58355 77355	....	34036 <sup>8</sup> 70164		G63306	82006	....	....	43093 <sup>9</sup> 49162 <sup>7</sup>
61-62	Todos		....	82035	....	....	....		....	82086	....	....	....

### PICKUP 1/2 TON, C10 ESTABILIZADORES DE DIRECCIÓN

		Delantero	Trasero
73-86	Estabilizador de Dirección Sistema Sencillo	6802SE <sup>84</sup>	....

























### PICKUP 1/2 TON, C15 / C1500

92-99	Todos		G63489	61544 81668	58489 77489	....	....		G63488	61543 81667	58488 77488	....	43163 <sup>9</sup> 49218 <sup>7</sup>
88-91	Todos		G63489	61544 81668	58489 77489	....	70164		G63488	61543 81667	58488 77488	....	43163 <sup>9</sup> 49218 <sup>7</sup> 70165
73-91	Todos		....	....	....	....	70164		....	....	....	....	70165

### PICKUP 1/2 TON, C15 / C1500 ESTABILIZADORES DE DIRECCIÓN

		Delantero	Trasero
92-99	Exc. Estabilizador de Dirección de EO	6853SE <sup>82</sup>	....

### PICKUP 1/2 TON, K10

81-86	Suspensión Estándar; Exc. Kit de Levantamiento		G63347	81113	58347	....	43107 <sup>8</sup>		....	....	58349	....	49155 <sup>7</sup>
	Suspensión Quad Amortiguador Corto; Exc. Kit de Levantamiento		G63908 <sup>6</sup>	61516	58908 <sup>6</sup>	....	....		....	....	....	....	....
	Suspensión Quad Amortiguador Largo; Exc. Kit de Levantamiento		G63906 <sup>6</sup>	61522 <sup>6</sup> 81496 <sup>6</sup>	58906 <sup>6</sup>	....	....	....		....	....	....	....
75-86	Exc. Suspensión Quad y Kit de Levantamiento		....	....	....	....	....		G63349	61524 81164	77349	....	43111 <sup>8</sup>
73-86	Con Kit de Levantamiento de 4"; Exc. Suspensión Quad		G63437 <sup>50</sup>	....	58437 <sup>50</sup>	....	....		G63438 <sup>50</sup>	....	58438 <sup>50</sup>	....	....
75-80	Exc. Kit de Levantamiento		G63347	61516 81113	58347	....	43107 <sup>8</sup>		....	....	58349	....	49155 <sup>7</sup>
74	Exc. Kit de Levantamiento		....	61516 81113	58347	....	43107 <sup>8</sup>		....	....	58349	....	49155 <sup>7</sup>
	Exc. Suspensión Quad y Kit de Levantamiento		G63347	....	....	....	....		G63349	61524 81164	77349	....	43111 <sup>8</sup>
73	Exc. Kit de Levantamiento		....	81113	58347	....	43107 <sup>8</sup>		....	....	58349	....	49155 <sup>7</sup>
	Exc. Suspensión Quad y Kit de Levantamiento		G63347	61516	....	....	....		G63349	61524 81164	77349	....	43111 <sup>8</sup>
69-72	Todos		G63347	....	....	....	....		G63371	....	....	....	....
	Exc. Kit de Levantamiento		G63347	61516 81113	58347	....	43107 <sup>8</sup>		G63371	....	....	....	....

### PICKUP 1/2 TON, K10 ESTABILIZADORES DE DIRECCIÓN

		Delantero	Trasero
73-86	Todos	14017	....
	Estabilizador de Dirección Sistema Dual	6802SE <sup>84</sup>	....

6 Se recomienda que cuando se reemplacen amortiguadores "quad", los 4 sean de la misma serie.

8 Paquetes en pares



82 Use kit si está señalado. Vea Ref. C para Botas.

7 Paquetes en pares; kit de mangueras de aire incluido

50 Para proteger la barra del pistón, se recomienda utilizar el kit Bellows No.141242.

84 Amortiguador de repuesto para los vehículos con el kit de montaje aftermarket GRC

# AMORTIGUADORES Y STRUTS

Año	Notas de Aplicación										
		Ultra	ProGuard\ Guardian	Max Control\ LTV	Protector de Strut\ Bases de Strut	HiJacker\ Soporte\ Hidráulico	Ultra	ProGuard\ Guardian	Max Control\ LTV	Protector de Strut\ Bases de Strut	HiJacker\ Soporte\ Hidráulico

## CHEVROLET

## CHEVROLET

### PICKUP 1/2 TON, K10 ESTABILIZADORES DE DIRECCIÓN (cont)

		Delantero	Trasero
73-86	Estabilizador de Dirección Sistema Sencillo	6804SE <sup>80</sup>	....
67-72	Estabilizador de Dirección Sistema Dual	6802SE <sup>84</sup>	....
61-72	Estabilizador de Dirección Sistema Sencillo	6803SE <sup>84</sup>	....

### PICKUP 1/2 TON, K15 / K1500

00	5.7L 8Cyl (350) MF1	....	....	....	....	....	....	....	....	....	....
88-99	Todos	G63818	....	58901 77609	....	....	G63488	61543 81667	58488 77488	....	43163 <sup>8</sup> 49218 <sup>7</sup>
88	Suspensión Quad Amortiguador Corto; Exc. Kit de Levantamiento	G63818	61516 <sup>6</sup>	58901 77609	....	....	G63488	61543 81667	58488 77488	....	43163 <sup>8</sup> 49218 <sup>7</sup>
	Suspensión Quad Amortiguador Largo; Exc. Kit de Levantamiento	G63818	61522 <sup>6</sup>	58901 77609	....	....	G63488	61543 81667	58488 77488	....	43163 <sup>8</sup> 49218 <sup>7</sup>

### PICKUP 1/2 TON, K15 / K1500 ESTABILIZADORES DE DIRECCIÓN

		Delantero	Trasero
88-99	Estabilizador de Dirección Sistema Sencillo	6807SE <sup>80</sup>	....
92-97	Exc. Estabilizador de Dirección de EO	6853SE <sup>80</sup>	....

### PICKUP 1/2 TON, R10

87	Todos	G63355	61525 81039	58355 77355	....	34036 <sup>8</sup>	G63349	61524 81164	58349 77349	....	43111 <sup>8</sup> 49155 <sup>7</sup>
----	-------	--------	----------------	----------------	------	--------------------	--------	----------------	----------------	------	--

### PICKUP 1/2 TON, R10 ESTABILIZADORES DE DIRECCIÓN

		Delantero	Trasero
87	Estabilizador de Dirección Sistema Sencillo	6802SE <sup>84</sup>	....

### PICKUP 1/2 TON, SILVERADO 1500

14	Todos	G51949	....	....	....	....	....	....	....	....	....
	Exc. Modelos Classic y Suspensión Electrónica Ajustable	G51949	....	....	....	....	G63959	....	....	....	....
07-13	Exc. Modelos Classic y Suspensión Electrónica Ajustable	G51870	....	....	143316 <sup>53</sup>	....	G63959	61690	....	....	....
99-07	4WD; Classic y Old Body Style; Exc. Suspensión Electrónica Ajustable	G63803	61643 81922	58803 77803	....	....	G63675	61642 81921	58412 77412	....	....
	RWD; Sólo Modelos Classic; Exc. Suspensión Electrónica Ajustable	G63783	61641 81920	58783 77783	....	....	G63662	61600 81873	58662 77662	....	43181 <sup>8</sup> 49235 <sup>7</sup>

### PICKUP 1/2 TON, SILVERADO 1500 HD

05-07	Todos	G63817	61663 81925	58817 77817	....	....	G63675	61642 81921	58412 77412	....	....
01-03	Todos	G63817	61663 81925	58817 77817	....	....	G63675	61642 81921	58412 77412	....	....

### PICKUP 1/2 TON, V10

87	Todos	....	....	....	....	....	....	....	....	....	49155 <sup>7</sup>
	Con Kit de Levantamiento de 4"; Exc. Suspensión Quad	G63437 <sup>50</sup>	....	58437 <sup>50</sup>	....	....	G63438 <sup>50</sup>	....	58438 <sup>50</sup>	....	49155 <sup>7</sup>
	Exc. Suspensión Quad y Kit de Levantamiento	G63347	....	58347	....	43107 <sup>8</sup>	G63349	61524 81164	58349 77349	....	43111 <sup>8</sup> 49155 <sup>7</sup>
	Suspensión Quad Amortiguador Corto; Exc. Kit de Levantamiento	G63908 <sup>6</sup>	61516 <sup>6</sup> 81113 <sup>6</sup>	58908 <sup>6</sup>	....	....	....	....	....	....	49155 <sup>7</sup>
	Suspensión Quad Amortiguador Largo; Exc. Kit de Levantamiento	G63906 <sup>6</sup>	61522 <sup>6</sup> 81496 <sup>6</sup>	58906 <sup>6</sup>	....	....	....	....	....	....	49155 <sup>7</sup>

6 Se recomienda que cuando se reemplacen amortiguadores "quad", los 4 sean de la misma serie.

8 Paquetes en pares

53 Montaje de Strut. Es probable reutilizar algunas partes del E.O.





84 Amortiguador de repuesto para los vehículos con el kit de montaje aftermarket GRC

7 Paquetes en pares; kit de mangueras de aire incluido

50 Para proteger la barra del pistón, se recomienda utilizar el kit Bellows No.141242.

80 No requiere soportes para el montaje, instalar sobre montajes de EO Veá Ref. C para Botas.

# AMORTIGUADORES Y STRUTS

Año	Notas de Aplicación										
			Ultra	ProGuard\ Guardian	Max Control\ LTV	Protector de Strut\ Bases de Strut	HiJacker\ Soporte\ Hidráulico		Ultra	ProGuard\ Guardian	Max Control\ LTV

















## CHEVROLET

## CHEVROLET

### PICKUP 1/2 TON, V10 ESTABILIZADORES DE DIRECCIÓN

		Delantero	Trasero
87	Todos	14017	....
	Estabilizador de Dirección Sistema Dual	6802SE <sup>84</sup>	....
	Estabilizador de Dirección Sistema Sencillo	6804SE <sup>80</sup>	....









### PICKUP 3/4 TON, C20

73-74	Todos		....	....	....	....	70164		....	....	....	....	
	Crew Cab Pickup		G63355	61525 81039	58355 77355	....	34036 <sup>8</sup> 70164		....	61649 81174	58366	....	....
	Standard Cab Pickup		....	....	....	....	70164		....	61524 81164	58349 77349	....	43111 <sup>8</sup> 49155 <sup>7</sup>
67-72	Todos		G63355	61525 81039	58355 77355	....	34036 <sup>8</sup> 70164		G63306	....	....	....	....
	Resorte Trasero		G63355	61525 81039	58355 77355	....	34036 <sup>8</sup> 70164		G63306	82003	....	....	43062 <sup>8</sup> 49107 <sup>7</sup>
	Resorte Trasero de Hojas Múltiples		G63355	61525 81039	58355 77355	....	34036 <sup>8</sup> 70164		G63306	82006	....	....	43093 <sup>8</sup> 49162 <sup>7</sup>
63-66	Todos		G63355	61525 81039	58355 77355	....	34036 <sup>8</sup> 70164		G63306	....	....	....	43093 <sup>8</sup> 49162 <sup>7</sup>
61-62	Todos		....	82035	....	....	....		....	82086	....	....	

### PICKUP 3/4 TON, C20 ESTABILIZADORES DE DIRECCIÓN

		Delantero	Trasero
63-74	Estabilizador de Dirección Sistema Sencillo	6802SE <sup>84</sup>	....





















### PICKUP 3/4 TON, C25 / C2500

92-00	Todos		G63489	61544 81668	58489 77489	....	....		G63488	61543 81667	58488 77488	....	43163 <sup>8</sup> 49218 <sup>7</sup>
88-91	Todos		G63489	61544 81668	58489 77489	....	70164		G63488	61543 81667	58488 77488	....	43163 <sup>8</sup> 49218 <sup>7</sup> 70165
	5.7L MFI		....	....	....	....	42961 70164		....	....	....	....	70165
73-91	Todos		....	....	....	....	70164		....	....	....	....	70165

### PICKUP 3/4 TON, C25 / C2500 ESTABILIZADORES DE DIRECCIÓN

		Delantero	Trasero
92-99	Exc. Estabilizador de Dirección de EO	6853SE <sup>82</sup>	....

### PICKUP 3/4 TON, K20

81-86	Suspensión Estándar; Exc. Kit de Levantamiento		G63347	81113	58347	....	43107 <sup>8</sup>		....	....	58349	....	49155 <sup>7</sup>
	Suspensión Quad Amortiguador Corto; Exc. Kit de Levantamiento		G63908 <sup>6</sup>	61516	58908 <sup>6</sup>	....	....		....	....	....	....	....
	Suspensión Quad Amortiguador Largo; Exc. Kit de Levantamiento		G63906 <sup>6</sup>	61522 <sup>6</sup> 81496 <sup>6</sup>	58906 <sup>6</sup>	....	....		....	....	....	....	....
75-86	Exc. Suspensión Quad y Kit de Levantamiento		....	....	....	....	....		G63349	61524 81164	77349	....	43111 <sup>8</sup>
73-86	Con Kit de Levantamiento de 4"; Exc. Suspensión Quad		G63437 <sup>50</sup>	....	58437 <sup>50</sup>	....	....		G63438 <sup>50</sup>	....	58438 <sup>50</sup>	....	....
75-80	Exc. Kit de Levantamiento		G63347	61516 81113	58347	....	43107 <sup>8</sup>		....	....	58349	....	49155 <sup>7</sup>
73-74	Exc. Kit de Levantamiento		....	61516 81113	58347	....	....		....	....	58349	....	49155 <sup>7</sup>
	Exc. Suspensión Quad y Kit de Levantamiento		G63347	....	....	....	43107 <sup>8</sup>		....	61524 81164	77349	....	43111 <sup>8</sup>
71-72	Todos		....	....	....	....	....		G63371	....	....	....	....
	Exc. Kit de Levantamiento		....	61516 81113	58347	....	....		G63371	....	....	....	....

6 Se recomienda que cuando se reemplacen amortiguadores "quad", los 4 sean de la misma serie.

8 Paquetes en pares

80 No requiere soportes para el montaje, instalar sobre montajes de EO Vea Ref. C para Botas.



84 Amortiguador de repuesto para los vehículos con el kit de montaje aftermarket GRC

7 Paquetes en pares; kit de mangueras de aire incluido

50 Para proteger la barra del pistón, se recomienda utilizar el kit Bellows No.141242.

82 Use kit si está señalado. Vea Ref. C para Botas.

# AMORTIGUADORES Y STRUTS

Año	Notas de Aplicación										
		Ultra	ProGuard\ Guardian	Max Control\ LTV	Protector de Strut\ Bases de Strut	HiJacker\ Soporte\ Hidráulico	Ultra	ProGuard\ Guardian	Max Control\ LTV	Protector de Strut\ Bases de Strut	HiJacker\ Soporte\ Hidráulico

## CHEVROLET

## CHEVROLET

### PICKUP 3/4 TON, K20 (cont)

71-72	Exc. Suspensión Quad y Kit de Levantamiento	<input type="radio"/>	G63347	....	....	....	....	<input type="radio"/>	G63371	....	....	....	....
69-70	Exc. Kit de Levantamiento	<input type="radio"/>	....	61516 81113	58347	....	....	<input type="radio"/>	....	....	....	....	....
	Exc. Suspensión Quad y Kit de Levantamiento	<input type="radio"/>	G63347	....	....	....	....	<input type="radio"/>	....	....	....	....	....

### PICKUP 3/4 TON, K20 ESTABILIZADORES DE DIRECCIÓN

		Delantero		Trasero	
73-86	Todos	14017		....	
	Estabilizador de Dirección Sistema Dual	6802SE <sup>84</sup>		....	
	Estabilizador de Dirección Sistema Sencillo	6804SE <sup>80</sup>		....	
67-72	Estabilizador de Dirección Sistema Dual	6802SE <sup>84</sup>		....	
61-72	Estabilizador de Dirección Sistema Sencillo	6803SE <sup>84</sup>		....	

### PICKUP 3/4 TON, K25 / K2500

88-00	Todos	<input type="radio"/>	G63609	61542 81726	58609 77609	....	....	<input type="radio"/>	G63488	61543 81667	58488 77488	....	43163 <sup>8</sup> 49218 <sup>7</sup>
-------	-------	-----------------------	--------	----------------	----------------	------	------	-----------------------	--------	----------------	----------------	------	--

### PICKUP 3/4 TON, K25 / K2500 ESTABILIZADORES DE DIRECCIÓN

		Delantero		Trasero	
99-00	Exc. Estabilizador de Dirección de EO	6853SE <sup>82</sup>		....	
88-99	Estabilizador de Dirección Sistema Sencillo	6807SE <sup>80</sup>		....	

### PICKUP 3/4 TON, R20

87-88	Crew Cab Pickup	<input type="radio"/>	G63355	61525 81039	58355 77355	....	34036 <sup>8</sup>	<input type="radio"/>	G63366	61649 81174	58366	....	....
87	Standard Cab Pickup	<input type="radio"/>	....	....	58355	....	....	<input type="radio"/>	G63349	61524 81164	58349 77349	....	43111 <sup>8</sup> 49155 <sup>7</sup>

### PICKUP 3/4 TON, R20 ESTABILIZADORES DE DIRECCIÓN

		Delantero		Trasero	
87-88	Estabilizador de Dirección Sistema Sencillo	6802SE <sup>84</sup>		....	

### PICKUP 3/4 TON, R2500

89	Todos	<input type="radio"/>	....	61525 81039	58355 77355	....	....	<input type="radio"/>	G63366	61649 81174	58366	....	....
	RWD	<input type="radio"/>	G63355	61525 81039	58355 77355	....	34036 <sup>8</sup>	<input type="radio"/>	G63366	61649 81174	58366	....	....

### PICKUP 3/4 TON, R2500 ESTABILIZADORES DE DIRECCIÓN

		Delantero		Trasero	
89	Estabilizador de Dirección Sistema Sencillo	6802SE <sup>84</sup>		....	

### PICKUP 3/4 TON, SILVERADO 2500

05-08	Todos	<input type="radio"/>	G63817	61663 81925	58817 77817	....	....	<input type="radio"/>	G63675	61642 81921	58412 77412	....	....
99-04	Todos	<input type="radio"/>	....	....	....	....	....	<input type="radio"/>	G63675	61642 81921	58412 77412	....	....
	4WD	<input type="radio"/>	G63817	61663 81925	58817 77817	....	....	<input type="radio"/>	G63675	61642 81921	58412 77412	....	....

### PICKUP 3/4 TON, SILVERADO 2500 HD

01-10	Todos	<input type="radio"/>	....	....	....	....	....	<input type="radio"/>	G63675	61642 81921	58412 77412	....	....
	PBV 9200	<input type="radio"/>	G63817	61663 81925	58817 77817	....	....	<input type="radio"/>	G63675	61642 81921	58412 77412	....	....

### PICKUP 3/4 TON, SILVERADO 2500 HD ESTABILIZADORES DE DIRECCIÓN

		Delantero		Trasero	
11-13	Todos	14075		....	

7 Paquetes en pares; kit de mangueras de aire incluido

8 Paquetes en pares



80 No requiere soportes para el montaje, instalar sobre montajes de EO Vea Ref. C para Botas.

82 Use kit si está señalado. Vea Ref. C para Botas.

84 Amortiguador de repuesto para los vehículos con el kit de montaje aftermarket

GRC

# AMORTIGUADORES Y STRUTS

Año	Notas de Aplicación										
		Ultra	ProGuard\ Guardian	Max Control\ LTV	Protector de Strut\ Bases de Strut	HiJacker\ Soporte\ Hidráulico	Ultra	ProGuard\ Guardian	Max Control\ LTV	Protector de Strut\ Bases de Strut	HiJacker\ Soporte\ Hidráulico

## CHEVROLET

## CHEVROLET

### PICKUP 3/4 TON, SILVERADO 2500 HD ESTABILIZADORES DE DIRECCIÓN (cont)

		Delantero	Trasero
01-09	9200# PBV sin Unidad de EO - 15059138 15155638	6803SE <sup>84</sup>	....
	4WD, PBV 9200 con Amortiguador de EO 15059138, 15155638	6853SE <sup>82</sup>	....

### PICKUP 3/4 TON, V20

87	Todos	....	....	....	....	....	....	....	....	49155 <sup>7</sup>		
	Con Kit de Levantamiento de 4"; Exc. Suspensión Quad	G63437 <sup>50</sup>	....	58437 <sup>50</sup>	....	....	....	G63438 <sup>50</sup>	....	58438 <sup>50</sup>	....	49155 <sup>7</sup>
	Exc. Suspensión Quad y Kit de Levantamiento	G63347	61516	58347	....	....	....	G63349	61524 81164	58349 77349	....	43111 <sup>8</sup> 49155 <sup>7</sup>
	Suspensión Quad Amortiguador Corto; Exc. Kit de Levantamiento	G63908 <sup>6</sup>	....	58908 <sup>6</sup>	....	....	....	....	....	....	....	49155 <sup>7</sup>
	Suspensión Quad Amortiguador Largo; Exc. Kit de Levantamiento	G63906 <sup>6</sup>	61522 <sup>6</sup> 81496 <sup>6</sup>	58906 <sup>6</sup>	....	....	....	....	....	....	....	49155 <sup>7</sup>

### PICKUP 3/4 TON, V20 ESTABILIZADORES DE DIRECCIÓN

		Delantero	Trasero
87	Todos	14017	....
	Estabilizador de Dirección Sistema Dual	6802SE <sup>84</sup>	....
	Estabilizador de Dirección Sistema Sencillo	6804SE <sup>80</sup>	....

### PICKUP 1 TON, C30

63-91	Todos	....	....	....	....	70164	....	....	....	....	
87	5.7L MFI	....	....	....	....	42961 70164	....	....	....	....	
79-86	5.7L MFI	....	....	....	....	42961 70164	....	....	....	42958	
75-86	Todos	G63355	61525 81039	58355 77355	....	34036 <sup>8</sup> 70164	G63366	61649 81174	58366	....	....
73-74	Todos	G63355	61525 81039	58355 77355	....	34036 <sup>8</sup> 70164	....	61649 81174	58366	....	....
67-72	Exc. Eje Trasero 11,000#	....	....	....	....	70164	G63306	82006	....	....	43093 <sup>8</sup> 49162 <sup>7</sup>
63-72	Todos	G63355	61525 81039	58355 77355	....	34036 <sup>8</sup> 70164	....	....	....	....	....
61-62	Todos	....	82035	....	....	....	....	....	....	....	....

### PICKUP 1 TON, C30 ESTABILIZADORES DE DIRECCIÓN

		Delantero	Trasero
73-86	Estabilizador de Dirección Sistema Sencillo c/ Cooler	6802SE <sup>84</sup>	....
61-72	Estabilizador de Dirección Sistema Sencillo	6802SE <sup>84</sup>	....

### PICKUP 1 TON, C35/3500

01-03	Base, Eje Delantero Rígido HD	....	....	77489	....	....	....	....	....	....	
	Eje Delantero Rígido HD	....	....	....	....	....	G63488	61543 81667	58488 77488	....	43163 <sup>9</sup> 49218 <sup>7</sup>
01-02	Eje Delantero Rígido HD	G63812	....	....	....	....	....	....	....	....	....
98-00	Crew Cab Pickup Eje Delantero Rígido HD	G63489	61544	58489	....	....	G63488	....	77488	....	....
	Eje Delantero Rígido HD	G63812	81668	58812 77489	....	....	....	61543	58488 77488	....	43163 <sup>9</sup> 49218 <sup>7</sup>
	Extended Cab Pickup Eje Delantero Rígido HD	G63489	61544	58489	....	....	G63488	81667	77488	....	....
	Standard Cab Pickup Eje Delantero Rígido HD	G63489	61544	58489	....	....	....	81667	77488	....	....
92-00	Todos	....	....	....	....	....	....	....	77488	....	....

6 Se recomienda que cuando se reemplacen amortiguadores "quad", los 4 sean de la misma serie.

8 Paquetes en pares

80 No requiere soportes para el montaje, instalar sobre montajes de EO Vea Ref. C para Botas.



84 Amortiguador de repuesto para los vehículos con el kit de montaje aftermarket GRC

7 Paquetes en pares; kit de mangueras de aire incluido

50 Para proteger la barra del pistón, se recomienda utilizar el kit Bellows No.141242.

82 Use kit si está señalado. Vea Ref. C para Botas.

# AMORTIGUADORES Y STRUTS

Año	Notas de Aplicación										
		Ultra	ProGuard\ Guardian	Max Control\ LTV	Protector de Strut\ Bases de Strut	HiJacker\ Soporte\ Hidráulico	Ultra	ProGuard\ Guardian	Max Control\ LTV	Protector de Strut\ Bases de Strut	HiJacker\ Soporte\ Hidráulico

## CHEVROLET

## CHEVROLET

### PICKUP 1 TON, C35/3500 (cont)

92-97	Crew Cab Pickup Eje Delantero Rígido HD	⊕	G63489	61544	58489 77489	....	....	⊕	G63488	....	77488	....	....
	Eje Delantero Rígido HD	⊕	G63812	81668	58812	....	....	⊕	....	61543	58488 77488	....	43163 <sup>8</sup> 49218 <sup>7</sup>
	Extended Cab Pickup Eje Delantero Rígido HD	⊕	G63489	61544	58489 77489	....	....	⊕	G63488	81667	77488	....	....
	Standard Cab Pickup Eje Delantero Rígido HD	⊕	G63489	61544	58489 77489	....	....	⊕	....	81667	77488	....	....
89-91	5.7L MFI	⊕	....	....	....	....	42961 70164	⊕	....	....	....	....	....
88-91	Cab & Chassis	⊕	....	61525 81039	77355	....	34036 <sup>8</sup> 70164	⊕	....	....	....	....	....
	Cab & Chassis Exc. Eje Rígido Delantero HD	⊕	G63355	....	58355	....	70164	⊕	G63366	61649 81174	58366	....	....
73-91	Todos	⊕	....	....	....	....	70164	⊕	....	....	....	....	....
91	Todos	⊕	....	....	....	....	70164	⊕	....	....	77488	....	42958
	Eje Delantero Rígido HD	⊕	G63812	....	58812	....	70164	⊕	....	61543	58488	....	43163 <sup>8</sup> 49218 <sup>7</sup>
	Extended Cab Pickup Eje Delantero Rígido HD	⊕	G63489	61544 81668	58489 77489	....	70164	⊕	G63488	81667	....	....	....
	Standard Cab Pickup Eje Delantero Rígido HD	⊕	G63489	61544 81668	58489 77489	....	70164	⊕	....	81667	....	....	....
89-90	Todos	⊕	....	....	....	....	70164	⊕	....	....	....	....	42958
88-90	Extended Cab Pickup Eje Delantero Rígido HD	⊕	G63489	61544 81668	58489 77489	....	70164	⊕	G63488	61543 81667	58488 77488	....	43163 <sup>8</sup> 49218 <sup>7</sup>
	Standard Cab Pickup Eje Delantero Rígido HD	⊕	G63489	61544 81668	58489 77489	....	70164	⊕	G63488	61543 81667	58488 77488	....	43163 <sup>8</sup> 49218 <sup>7</sup>

### PICKUP 1 TON, C35/3500 ESTABILIZADORES DE DIRECCIÓN

		Delantero		Trasero	
91-03	Estabilizador de Dirección Sistema Sencillo Pickup HD	6807SE <sup>80</sup>		....	

### PICKUP 1 TON, K30

77-86	Todos	⊕	G63411	....	58411	....	....	⊕	G63675	61642 81921	58412 77412	....	....
-------	-------	---	--------	------	-------	------	------	---	--------	----------------	----------------	------	------

### PICKUP 1 TON, K30 ESTABILIZADORES DE DIRECCIÓN

		Delantero		Trasero	
77-86	Todos	14017		....	
	Estabilizador de Dirección Sistema Dual	6802SE <sup>84</sup>		....	
	Estabilizador de Dirección Sistema Sencillo	6804SE <sup>80</sup>		....	
73-74	Todos	14017		....	

### PICKUP 1 TON, K35 / K3500

88-00	Todos	⊕	G63609	61542 81726	58609 77609	....	....	⊕	G63488	61543 81667	58488 77488	....	43163 <sup>8</sup> 49218 <sup>7</sup>
-------	-------	---	--------	----------------	----------------	------	------	---	--------	----------------	----------------	------	--

### PICKUP 1 TON, K35 / K3500 ESTABILIZADORES DE DIRECCIÓN

		Delantero		Trasero	
95-00	Exc. Estabilizador de Dirección de EO	6853SE		....	
88-00	Estabilizador de Dirección Sistema Sencillo	6807SE <sup>80</sup>		....	

### PICKUP 1 TON, R30

87-88	Todos	⊕	G63355	61525 81039	58355 77355	....	34036 <sup>8</sup>	⊕	G63366	61649 81174	58366	....	....
-------	-------	---	--------	----------------	----------------	------	--------------------	---	--------	----------------	-------	------	------

### PICKUP 1 TON, R30 ESTABILIZADORES DE DIRECCIÓN

		Delantero		Trasero	
87-88	Estabilizador de Dirección Sistema Sencillo c/ Cooler	6802SE <sup>84</sup>		....	

7 Paquetes en pares; kit de mangueras de aire incluido





8 Paquetes en pares

80 No requiere soportes para el montaje, instalar sobre montajes de EO Veá Ref. C para Botas.

84 Amortiguador de repuesto para los vehículos con el kit de montaje aftermarket GRC









# AMORTIGUADORES Y STRUTS

Año	Notas de Aplicación										
			Ultra	ProGuard\ Guardian	Max Control\ LTV	Protector de Strut\ Bases de Strut	HiJacker\ Soporte\ Hidráulico		Ultra	ProGuard\ Guardian	Max Control\ LTV

## CHEVROLET

## CHEVROLET



### PICKUP 1 TON, R3500

90-91	Todos		G63411	81039	58411	....	....		G63675	61642 81921	58412 77412	....	....
89	Exc. Standard Cab		G63411	....	58411	....	....		G63675	61642 81921	58412 77412	....	....
	Standard Cab Pickup		G63355	61525 81039	58355 77355	....	34036 <sup>8</sup>		G63366	61649 81174	58366	....	....



### PICKUP 1 TON, R3500 ESTABILIZADORES DE DIRECCIÓN

		Delantero		Trasero	
89-91	Todos	14017		....	
	Estabilizador de Dirección Sistema Sencillo c/ Cooler	6802SE <sup>84</sup>		....	

### PICKUP 1 TON, SILVERADO 3500

01-09	Todos		G63817	61663 81925	58817 77817	....	....		G63675	61642 81921	58412 77412	....	....
-------	-------	---	--------	----------------	----------------	------	------	---	--------	----------------	----------------	------	------



### PICKUP 1 TON, SILVERADO 3500 HD

07-10	Todos		G63817	61663 81925	58817 77817	....	....		G63675	61642 81921	58412 77412	....	....
-------	-------	---	--------	----------------	----------------	------	------	---	--------	----------------	----------------	------	------

### PICKUP 1 TON, SILVERADO 3500 HD ESTABILIZADORES DE DIRECCIÓN

		Delantero		Trasero	
11-13	Todos	14075		....	



### PICKUP 1 TON, V30

87-88	Todos		G63411	....	58411	....	....		G63675	61642 81921	58412 77412	....	....
-------	-------	--	--------	------	-------	------	------	--	--------	----------------	----------------	------	------

### PICKUP 1 TON, V30 ESTABILIZADORES DE DIRECCIÓN

		Delantero		Trasero	
87-88	Todos	14017		....	























### PICKUP 1 TON, V3000 / V3500

89-91	Todos		G63411	....	58411	....	....		G63675	61642 81921	58412 77412	....	....
-------	-------	---	--------	------	-------	------	------	---	--------	----------------	----------------	------	------

### PICKUP 1 TON, V3000 / V3500 ESTABILIZADORES DE DIRECCIÓN

		Delantero		Trasero	
89-91	Todos	14017		....	





### S10

99-04	4WD; Exc. ZR2, ZR5 or Sport Chassis		G63423	61531 81516	58423 77423	....	....		G63422	61528 81482	58422 77422	....	43162 <sup>8</sup> 49213 <sup>7</sup>
88-04	4WD; Barra de Torsion(FrontSpringType)		....	....	....	142316 <sup>83</sup>	....		....	....	....	....	....
99-03	RWD; Exc. Sport Chassis or Xtreme Chassis		G63421	61504 81750	58421 77421	....	34051 <sup>8</sup>		G63422	61528 81482	58422 77422	....	43162 <sup>8</sup> 49213 <sup>7</sup>
92-98	4WD; Exc. ZR2, ZR5 or Sport Chassis		G63423	61531 81516	58423 77423	....	....		G63422	61528 81482	58422 77422	....	....
	Exc. ZR2, ZR5 or Sport Chassis		....	....	....	....	....		G63422	61528 81482	58422 77422	....	43162 <sup>8</sup> 49213 <sup>7</sup>
	RWD; Exc. Sport Chassis or Xtreme Chassis		G63421	61504 81750	58421 77421	....	34051 <sup>8</sup>		....	....	....	....	....
91	4WD; Exc. ZR2, Baja & Sport Chassis		G63423	61531 81516	58423 77423	....	....		....	....	....	....	....
	Exc. ZR2, Baja & Sport Chassis		....	....	....	....	....		G63422	61528 81482	58422 77422	....	43162 <sup>8</sup> 49213 <sup>7</sup>
	RWD; Exc. ZR2, Baja & Sport Chassis		G63421	61504 81750	58421 77421	....	34051 <sup>8</sup>		....	....	....	....	....
83-90	4WD; Exc. ZR2, ZR5 or Sport Chassis		G63423	61531 81516	58423 77423	....	....		....	....	....	....	....
82-90	Exc. ZR2, ZR5 or Sport Chassis		....	....	....	....	....		G63422	61528 81482	58422 77422	....	43162 <sup>8</sup> 49213 <sup>7</sup>
	RWD; Exc. Sport Chassis or Xtreme Chassis		G63421	61504 81750	58421 77421	....	34051 <sup>8</sup>		....	....	....	....	....

7 Paquetes en pares; kit de mangueras de aire incluido  
53 Montaje de Strut. Es probable reutilizar algunas partes del E.O.

8 Paquetes en pares  
84 Amortiguador de repuesto para los vehiculos con el kit de montaje aftermarket  
GRC

# AMORTIGUADORES Y STRUTS

Año	Notas de Aplicación										
		 Ultra	ProGuard\ Guardian	Max Control\ LTV	Protector de Strut\ Bases de Strut	HiJacker\ Soporte\ Hidráulico	 Ultra	ProGuard\ Guardian	Max Control\ LTV	Protector de Strut\ Bases de Strut	HiJacker\ Soporte\ Hidráulico

## CHEVROLET

## CHEVROLET

























### S10 ESTABILIZADORES DE DIRECCIÓN

		Delantero	Trasero
83-04	4WD, Estabilizador de Dirección Sistema Sencillo; con orificio de montaje de EO en brazo de dirección	6801SE	....
	4WD, Estabilizador de Dirección Sistema Sencillo; sin orificio de montaje de EO en brazo de dirección	6851SE	....
82-03	RWD, Estabilizador de Dirección Sistema Sencillo	6802SE <sup>84</sup>	....
	RWD, Estabilizador de Dirección Sistema Sencillo; sin Estabilizador de Dirección de EO	6849SE <sup>82</sup>	....

### SONORA

00-02	Todos	 G63783	61641	....	....	....	 G63662	61600 81873	....	....	....
-------	-------	--	-------	------	------	------	--	----------------	------	------	------













### SUBURBAN 1/2 TON, 1500

12-14	Todos	....	....	....	....	....	 G64101	....	....	....	....
14	Exc. Suspensión Z55 o ZW7	 G51891	....	....	....	....	 G64101	....	....	....	....
12-13	Exc. Suspensión Z55 o ZW7	 G51891	....	....	143316 <sup>53</sup>	....	 G64101	....	....	....	....
09-11	Exc. Suspensión Z55 Auto Ride	....	....	....	....	....	 .....	....	58930	....	....
	Exc. Suspensión Z55 o ZW7	 G51891	....	....	143316 <sup>53</sup>	....	 G63866	61675 81930	77953	....	....
08	Exc. Suspensión Z55 o ZW7	 G51891	....	....	143316 <sup>53</sup>	....	 G63866	61675 81930	58930 77953	....	....
07	Exc. Suspensión Z55 Auto Ride	....	....	....	....	....	 .....	....	58930	....	....
	Exc. Suspensión Z55 o ZW7	 G51891	....	....	143316 <sup>53</sup>	....	 G63866	61675 81930	77953	....	....
00-06	Todos	....	....	....	....	....	 .....	....	....	....	49616
	Exc. Suspensión Z55 Auto Ride	 G63803	61643 81922	58803 77803	....	....	 G63866	61675 81930	58930 77953	....	43182 49616
67	Todos	 G63355	61525 81039	58355 77355	....	34036 <sup>8</sup>	 .....	....	....	....	43062 <sup>8</sup>
	Resorte Trasero	 G63355	61525 81039	58355 77355	....	34036 <sup>8</sup>	 .....	82003	....	....	49107 <sup>7</sup> 43062 <sup>8</sup>
63-66	Todos	 G63355	61525 81039	58355 77355	....	34036 <sup>8</sup>	 G63306	82006	....	....	43093 <sup>8</sup> 49162 <sup>7</sup>
61-62	Todos	 .....	82035	....	....	....	 .....	82086	....	....	....
60	Todos	....	....	....	....	....	 .....	82086	....	....	....

### SUBURBAN 1/2 TON, 1500 ESTABILIZADORES DE DIRECCIÓN

		Delantero	Trasero
00-05	4WD, Exc. Estabilizador de Dirección de EO	6853SE <sup>82</sup>	....

### SUBURBAN 1/2 TON, C10

87-91	RWD	 .....	....	....	....	70164	 .....	....	....	....	70165
73-86	Todos	 G63355	61525 81039	58355 77355	....	34036 <sup>8</sup>	 G63349	61524 81164	58349 77349	....	43111 <sup>8</sup> 49155 <sup>7</sup>
	RWD	 G63355	61525 81039	58355 77355	....	70164 34036 <sup>8</sup>	 G63349	61524 81164	58349 77349	....	70165 43111 <sup>8</sup> 49155 <sup>7</sup>
68-72	Todos	 G63355	61525 81039	58355 77355	....	34036 <sup>8</sup>	 .....	82003	....	....	43062 <sup>8</sup> 49107 <sup>7</sup>
67	Todos	 G63355	61525 81039	58355 77355	....	34036 <sup>8</sup>	 .....	....	....	....	43062 <sup>8</sup>
63-66	Todos	 G63355	61525 81039	58355 77355	....	34036 <sup>8</sup>	 .....	....	....	....	....

### SUBURBAN 1/2 TON, C10 ESTABILIZADORES DE DIRECCIÓN

		Delantero	Trasero
68-86	Estabilizador de Dirección Sistema Sencillo	6802SE <sup>84</sup>	....

7 Paquetes en pares; kit de mangueras de aire incluido

53 Montaje de Strut. Es probable reutilizar algunas partes del E.O.





84 Amortiguador de repuesto para los vehículos con el kit de montaje aftermarket

GRC

8 Paquetes en pares

82 Use kit si está señalado. Vea Ref. C para Botas.



# AMORTIGUADORES Y STRUTS

Año	Notas de Aplicación										
			Ultra	ProGuard\ Guardian	Max Control\ LTV	Protector de Strut\ Bases de Strut	HiJacker\ Soporte\ Hidráulico		Ultra	ProGuard\ Guardian	Max Control\ LTV

## CHEVROLET

## CHEVROLET

























### SUBURBAN 1/2 TON, C15 / C1500

92-99	Todos		G63489	61544 81668	58489 77489	....	....		G63896	61565 81789	58638 77638	....	43180 <sup>8</sup> 49231 <sup>7</sup>
-------	-------	---	--------	----------------	----------------	------	------	---	--------	----------------	----------------	------	--

### SUBURBAN 1/2 TON, C15 / C1500 ESTABILIZADORES DE DIRECCIÓN

										Delantero	Trasero		
92-99	RWD											6852SE <sup>82</sup>	....



### SUBURBAN 1/2 TON, K10

81-86	Suspensión Estándar; Exc. Kit de Levantamiento		G63347	81113	58347 77355	....	43107 <sup>8</sup>		....	....	58349	....	49155 <sup>7</sup>
	Suspensión Quad Amortiguador Corto; Exc. Kit de Levantamiento		G63908 <sup>6</sup>	61516	58908 <sup>6</sup> 77355	....	....		....	....	....	....	....
	Suspensión Quad Amortiguador Largo; Exc. Kit de Levantamiento		G63906 <sup>6</sup>	61522 <sup>6</sup> 81496 <sup>6</sup>	58906 <sup>6</sup> 77355	....	....		....	....	....	....	....
75-86	Exc. Suspensión Quad y Kit de Levantamiento		....	....	77355	....	....		G63349	61524 81164	77349	....	43111 <sup>8</sup>
73-86	Todos		....	....	77355	....	....		....	....	....	....	....
	Con Kit de Levantamiento de 4"; Exc. Suspensión Quad		G63437 <sup>50</sup>	....	58437 <sup>50</sup> 77355	....	....		G63438 <sup>50</sup>	....	58438 <sup>50</sup>	....	....
73-80	Exc. Kit de Levantamiento		G63347	61516 81113	58347 77355	....	43107 <sup>8</sup>		....	....	58349	....	49155 <sup>7</sup>
73-74	Exc. Suspensión Quad y Kit de Levantamiento		....	....	77355	....	....		G63349	61524	77349	....	43111 <sup>8</sup>
71-72	Todos		....	....	77355	....	....		G63371	....	....	....	....
	Exc. Kit de Levantamiento		G63347	61516 81113	58347 77355	....	43107 <sup>8</sup>		G63371	....	....	....	....
69-70	Exc. Kit de Levantamiento		G63347	61516 81113	58347 77355	....	43107 <sup>8</sup>		....	....	....	....	....
68-70	Todos		....	....	77355	....	....		....	....	....	....	....

### SUBURBAN 1/2 TON, K10 ESTABILIZADORES DE DIRECCIÓN

										Delantero	Trasero		
73-86	Todos											14017	....
										Estabilizador de Dirección Sistema Dual	6802SE <sup>84</sup>	....	
										Estabilizador de Dirección Sistema Sencillo	6804SE <sup>80</sup>	....	
68-72	Estabilizador de Dirección Sistema Dual											6802SE <sup>84</sup>	....
	Estabilizador de Dirección Sistema Sencillo											6803SE <sup>84</sup>	....





### SUBURBAN 1/2 TON, K15 / K1500

92-99	Todos		G63609	61542 81726	58609 77609	....	....		G63638	61565 81789	58638 77638	....	43180 <sup>8</sup> 49231 <sup>7</sup>
-------	-------	---	--------	----------------	----------------	------	------	---	--------	----------------	----------------	------	--

### SUBURBAN 1/2 TON, K15 / K1500 ESTABILIZADORES DE DIRECCIÓN

										Delantero	Trasero		
92-97	Estabilizador de Dirección Sistema Sencillo											6807SE <sup>80</sup>	....

### SUBURBAN 1/2 TON, R10

87-88	Todos		G63355	61525 81039	58355 77355	....	34036 <sup>8</sup>		G63349	61524 81164	58349 77349	....	43111 <sup>8</sup> 49155 <sup>7</sup>
	Exc. Suspensión Quad y Kit de Levantamiento		G63355	61525 81039	58355 77355	....	43107 <sup>8</sup> 34036 <sup>8</sup>		G63349	61524 81164	58349 77349	....	43111 <sup>8</sup> 49155 <sup>7</sup>

### SUBURBAN 1/2 TON, R10 ESTABILIZADORES DE DIRECCIÓN

										Delantero	Trasero		
87-88	Todos											14017	....
										Estabilizador de Dirección Sistema Dual	6802SE <sup>84</sup>	....	
										Estabilizador de Dirección Sistema Sencillo	6804SE <sup>80</sup>	....	

6 Se recomienda que cuando se reemplacen amortiguadores "quad", los 4 sean de la misma serie.

8 Paquetes en pares

80 No requiere soportes para el montaje, instalar sobre montajes de EO Vea Ref. C para Botas.



84 Amortiguador de repuesto para los vehículos con el kit de montaje aftermarket GRC

7 Paquetes en pares; kit de mangueras de aire incluido

50 Para proteger la barra del pistón, se recomienda utilizar el kit Bellows No.141242.

82 Use kit si está señalado. Vea Ref. C para Botas.

# AMORTIGUADORES Y STRUTS

Año	Notas de Aplicación										
		Ultra	ProGuard\ Guardian	Max Control\ LTV	Protector de Strut\ Bases de Strut	HiJacker\ Soporte\ Hidráulico	Ultra	ProGuard\ Guardian	Max Control\ LTV	Protector de Strut\ Bases de Strut	HiJacker\ Soporte\ Hidráulico

## CHEVROLET

## CHEVROLET

### SUBURBAN 1/2 TON, R1500

89-91	Todos	○	G63355	61525 81039	58355 77355	....	34036 <sup>6</sup>	○	G63349	61524 81164	58349 77349	....	43111 <sup>8</sup> 49155 <sup>7</sup>
-------	-------	---	--------	----------------	----------------	------	--------------------	---	--------	----------------	----------------	------	--

### SUBURBAN 1/2 TON, R1500 ESTABILIZADORES DE DIRECCIÓN

89-91	Estabilizador de Dirección Sistema Sencillo									6802SE <sup>84</sup>		....
-------	---	--	--	--	--	--	--	--	--	----------------------	--	------

### SUBURBAN 1/2 TON, V10

87-88	Exc. Suspensión Quad y Kit de Levantamiento	○	....	....	....	....	....	○	....	....	58349	....	....
	Suspensión Quad Amortiguador Corto; Exc. Kit de Levantamiento	○	....	61516 <sup>6</sup> 81113 <sup>6</sup>	....	....	....	○	....	....	....	....	....
	Suspensión Quad Amortiguador Largo; Exc. Kit de Levantamiento	○	....	61522 <sup>6</sup> 81496 <sup>6</sup>	....	....	....	○	....	....	....	....	....

### SUBURBAN 1/2 TON, V1500

89-91	Todos	○	....	....	....	....	....	○	....	....	....	....	49155 <sup>7</sup>
	Exc. Kit de Levantamiento	○	....	....	....	....	....	○	....	81164	....	....	49155 <sup>7</sup>
	Exc. Suspensión Quad y Kit de Levantamiento	○	....	61516	....	....	....	○	G63349	61524	58349 77349	....	43111 <sup>8</sup> 49155 <sup>7</sup>
	Suspensión Quad Amortiguador Corto; Exc. Kit de Levantamiento	○	G63908 <sup>6</sup>	....	....	....	....	○	....	....	....	....	49155 <sup>7</sup>
	Suspensión Quad Amortiguador Largo; Exc. Kit de Levantamiento	○	G63906 <sup>6</sup>	....	....	....	....	○	....	....	....	....	49155 <sup>7</sup>
	4WD, Con Kit de Levantamiento de 4 <sup>ta</sup> ; Exc. Suspensión Quad	○	G63437 <sup>50</sup>	....	58437 <sup>50</sup>	....	....	....	○	....	....	....	....

### SUBURBAN 3/4 TON, 2500

00-11	Exc. Suspensión Auto Ride Z55 y QuadraSteer	○	G63817	61663 81925	58817 77817	....	....	○	G63866	61675 81930	58930 77953	....	....
-------	---	---	--------	----------------	----------------	------	------	---	--------	----------------	----------------	------	------

### SUBURBAN 3/4 TON, 2500 ESTABILIZADORES DE DIRECCIÓN

00-05	4WD, Exc. Estabilizador de Dirección de EO									6853SE <sup>82</sup>		....
-------	--	--	--	--	--	--	--	--	--	----------------------	--	------

### SUBURBAN 3/4 TON, C20

73-86	Todos	○	G63355	61525 81039	58355 77355	....	34036 <sup>6</sup>	○	G63349	61524 81164	58349 77349	....	43111 <sup>8</sup> 49155 <sup>7</sup>
68-72	Todos	○	G63355	61525 81039	58355 77355	....	34036 <sup>6</sup>	○	....	82003	....	....	43062 <sup>8</sup> 49107 <sup>7</sup>
67	Todos	○	....	61525	....	....	34036 <sup>6</sup>	○	....	....	....	....	....
65-66	Todos	○	....	....	....	....	34036 <sup>6</sup>	○	....	....	....	....	....

### SUBURBAN 3/4 TON, C20 ESTABILIZADORES DE DIRECCIÓN

68-86	Estabilizador de Dirección Sistema Sencillo									6802SE <sup>84</sup>		....
-------	---	--	--	--	--	--	--	--	--	----------------------	--	------

### SUBURBAN 3/4 TON, C25 / C2500

92-99	Todos	○	G63489	61544 81668	58489 77489	....	....	○	G63896	61565 81789	58638 77638	....	43180 <sup>8</sup> 49231 <sup>7</sup>
-------	-------	---	--------	----------------	----------------	------	------	---	--------	----------------	----------------	------	--

### SUBURBAN 3/4 TON, C25 / C2500 ESTABILIZADORES DE DIRECCIÓN

92-99	RWD									6852SE <sup>82</sup>		....
-------	-----	--	--	--	--	--	--	--	--	----------------------	--	------

### SUBURBAN 3/4 TON, K20

81-86	Exc. Kit de Levantamiento	○	....	....	....	....	....	○	....	81164	....	....	....
	Suspensión Estándar; Exc. Kit de Levantamiento	○	G63347	81113	58347	....	....	○	....	....	58349	....	49155 <sup>7</sup>
	Suspensión Quad Amortiguador Corto; Exc. Kit de Levantamiento	○	G63908 <sup>6</sup>	61516	58908 <sup>6</sup>	....	....	....	○	....	....	....	....

6 Se recomienda que cuando se reemplacen amortiguadores "quad", los 4 sean de la misma serie.

8 Paquetes en pares





82 Use kit si está señalado. Vea Ref. C para Botas.

7 Paquetes en pares; kit de mangueras de aire incluido

50 Para proteger la barra del pistón, se recomienda utilizar el kit Bellows No.141242.

84 Amortiguador de repuesto para los vehículos con el kit de montaje aftermarket GRC

# AMORTIGUADORES Y STRUTS

Año	Notas de Aplicación										
			Ultra	ProGuard\ Guardian	Max Control\ LTV	Protector de Strut\ Bases de Strut	HiJacker\ Soporte\ Hidráulico		Ultra	ProGuard\ Guardian	Max Control\ LTV

## CHEVROLET

## CHEVROLET

### SUBURBAN 3/4 TON, K20 (cont)

81-86	Suspensión Quad Amortiguador Largo; Exc. Kit de Levantamiento	<input type="radio"/>	G63906 <sup>6</sup>	61522 <sup>2</sup> 81496 <sup>6</sup>	58906 <sup>6</sup>	....	....	<input type="radio"/>	....	....	....	....
73-86	Con Kit de Levantamiento de 4"; Exc. Suspensión Quad	<input type="radio"/>	G63437 <sup>50</sup>	....	58437 <sup>50</sup>	....	....	<input type="radio"/>	G63438 <sup>50</sup>	....	58438 <sup>50</sup>	....
	Exc. Suspensión Quad y Kit de Levantamiento	<input type="radio"/>	....	....	77355	....	....	<input type="radio"/>	G63349	61524	77349	43111 <sup>8</sup>
73-80	Exc. Kit de Levantamiento	<input type="radio"/>	G63347	61516 81113	58347	....	....	<input type="radio"/>	....	81164	58349	49155 <sup>7</sup>
71-72	Exc. Suspensión Quad y Kit de Levantamiento	<input type="radio"/>	....	....	77355	....	....	<input type="radio"/>	G63371	....	....	....
69-72	Exc. Kit de Levantamiento	<input type="radio"/>	G63347	61516 81113	58347	....	....	<input type="radio"/>	....	....	....	....
68-70	Exc. Suspensión Quad y Kit de Levantamiento	<input type="radio"/>	....	....	77355	....	....	<input type="radio"/>	....	....	....	....

### SUBURBAN 3/4 TON, K20 ESTABILIZADORES DE DIRECCIÓN

		Delantero		Trasero	
73-86	Todos	14017		....	
	Estabilizador de Dirección Sistema Dual	6802SE <sup>84</sup>		....	
	Estabilizador de Dirección Sistema Sencillo	6804SE <sup>80</sup>		....	
68-72	Estabilizador de Dirección Sistema Dual	6802SE <sup>84</sup>		....	
	Estabilizador de Dirección Sistema Sencillo	6803SE <sup>84</sup>		....	

### SUBURBAN 3/4 TON, K25 / K2500

92-99	Todos	<input type="radio"/>	G63609	61542 81726	58609 77609	....	....	<input type="radio"/>	G63638	61565 81789	58638 77638	....	43180 <sup>8</sup> 49231 <sup>7</sup>
-------	-------	-----------------------	--------	----------------	----------------	------	------	-----------------------	--------	----------------	----------------	------	--

### SUBURBAN 3/4 TON, K25 / K2500 ESTABILIZADORES DE DIRECCIÓN

		Delantero		Trasero	
95-99	Exc. Estabilizador de Dirección de EO	6853SE <sup>82</sup>		....	
92-97	Estabilizador de Dirección Sistema Sencillo	6807SE <sup>80</sup>		....	

### SUBURBAN 3/4 TON, R20

87-88	Todos	<input type="radio"/>	G63355	61525 81039	58355 77355	....	34036 <sup>8</sup>	<input type="radio"/>	G63349	61524 81164	58349 77349	....	43111 <sup>8</sup> 49155 <sup>7</sup>
-------	-------	-----------------------	--------	----------------	----------------	------	--------------------	-----------------------	--------	----------------	----------------	------	--

### SUBURBAN 3/4 TON, R20 ESTABILIZADORES DE DIRECCIÓN

		Delantero		Trasero	
87-88	Estabilizador de Dirección Sistema Sencillo	6802SE <sup>84</sup>		....	

### SUBURBAN 3/4 TON, R2500

89-91	Todos	<input type="radio"/>	G63355	61525 81039	58355 77355	....	34036 <sup>8</sup>	<input type="radio"/>	G63349	61524 81164	58349 77349	....	43111 <sup>8</sup> 49155 <sup>7</sup>
-------	-------	-----------------------	--------	----------------	----------------	------	--------------------	-----------------------	--------	----------------	----------------	------	--

### SUBURBAN 3/4 TON, R2500 ESTABILIZADORES DE DIRECCIÓN

		Delantero		Trasero	
89-91	Estabilizador de Dirección Sistema Sencillo	6802SE <sup>84</sup>		....	

### SUBURBAN 3/4 TON, V20

87-88	Todos	<input type="radio"/>	....	....	....	....	....	<input type="radio"/>	....	....	....	....	49155 <sup>7</sup>
	Con Kit de Levantamiento de 4"; Exc. Suspensión Quad	<input type="radio"/>	G63437 <sup>50</sup>	....	58437 <sup>50</sup>	....	....	<input type="radio"/>	G63438 <sup>50</sup>	....	58438 <sup>50</sup>	....	49155 <sup>7</sup>
	Exc. Suspensión Quad y Kit de Levantamiento	<input type="radio"/>	G63347	....	58347	....	....	<input type="radio"/>	G63349	61524 81164	58349 77349	....	43111 <sup>8</sup> 49155 <sup>7</sup>
	Suspensión Quad Amortiguador Corto; Exc. Kit de Levantamiento	<input type="radio"/>	G63908 <sup>8</sup>	61516 81113 <sup>6</sup>	58908 <sup>6</sup>	....	....	....	<input type="radio"/>	....	....	....	49155 <sup>7</sup>
	Suspensión Quad Amortiguador Largo; Exc. Kit de Levantamiento	<input type="radio"/>	G63906 <sup>6</sup>	61522 <sup>2</sup> 81496 <sup>6</sup>	58906 <sup>6</sup>	....	....	....	<input type="radio"/>	....	....	....	49155 <sup>7</sup>

6 Se recomienda que cuando se reemplacen amortiguadores "quad", los 4 sean de la misma serie.

8 Paquetes en pares

80 No requiere soportes para el montaje, instalar sobre montajes de EO Vea Ref. C para Botas.



84 Amortiguador de repuesto para los vehículos con el kit de montaje aftermarket GRC

7 Paquetes en pares; kit de mangueras de aire incluido

50 Para proteger la barra del pistón, se recomienda utilizar el kit Bellows No.141242.

82 Use kit si está señalado. Vea Ref. C para Botas.

# AMORTIGUADORES Y STRUTS

Año	Notas de Aplicación										
		Ultra	ProGuard\ Guardian	Max Control\ LTV	Protector de Strut\ Bases de Strut	HiJacker\ Soporte\ Hidráulico	Ultra	ProGuard\ Guardian	Max Control\ LTV	Protector de Strut\ Bases de Strut	HiJacker\ Soporte\ Hidráulico

## CHEVROLET

## CHEVROLET

### SUBURBAN 3/4 TON, V20 ESTABILIZADORES DE DIRECCIÓN

		Delantero	Trasero
87-88	Todos	14017	....
	Estabilizador de Dirección Sistema Dual	6802SE <sup>84</sup>	....
	Estabilizador de Dirección Sistema Sencillo	6804SE <sup>80</sup>	....

### SUBURBAN 3/4 TON, V2500

89-91	Todos	....	....	....	....	....	....	....	49155 <sup>7</sup>
	Con Kit de Levantamiento de 4"; Exc. Suspensión Quad	G63437 <sup>50</sup>	....	58437 <sup>50</sup>	....	....	....	G63438 <sup>50</sup>	49155 <sup>7</sup>
	Exc. Suspensión Quad y Kit de Levantamiento	G63347	....	58347	....	....	....	G63349	43111 <sup>8</sup> 49155 <sup>7</sup>
	Suspensión Quad Amortiguador Corto; Exc. Kit de Levantamiento	G63908 <sup>6</sup>	61516 81113 <sup>6</sup>	58908 <sup>5</sup>	....	....	....	....	49155 <sup>7</sup>
	Suspensión Quad Amortiguador Largo; Exc. Kit de Levantamiento	G63906 <sup>6</sup>	61522 <sup>6</sup> 81496 <sup>6</sup>	58906 <sup>5</sup>	....	....	....	....	49155 <sup>7</sup>

### SUBURBAN 3/4 TON, V2500 ESTABILIZADORES DE DIRECCIÓN

		Delantero	Trasero
89-91	Todos	14017	....
	Estabilizador de Dirección Sistema Dual	6802SE <sup>84</sup>	....
	Estabilizador de Dirección Sistema Sencillo	6804SE <sup>80</sup>	....

## TAHOE

12-14	Todos	....	....	....	....	....	....	G64101	....	....	....	....
14	Exc. Suspensión Z55 o ZW7	G51891	....	....	....	....	....	G64101	....	....	....	....
12-13	Exc. Suspensión Z55 o ZW7	G51891	....	....	143316 <sup>53</sup>	....	....	G64101	....	....	....	....
07-11	Exc. Suspensión Z55 o ZW7	G51891	....	....	143316 <sup>53</sup>	....	....	G63866	61675 81930	58930 77953	....	....
02-06	Exc. Suspensión Z55 Auto Ride	G63803	61643 81922	58803 77803	....	....	....	....	61675 81930	77953	....	43182 49616
	Exc. Suspensión Z55 o ZW7	....	....	....	....	....	....	G63866	....	58930	....	49616
00-06	Todos	....	....	....	....	....	....	....	....	....	....	49616
00-01	Estilo New Body, Exc. Suspensión Z55	G63803	61643 81922	58803 77803	....	....	....	G63866	61675 81930	58930 77953	....	49616
	Exc. Suspensión Z55 Auto Ride	....	....	....	....	....	....	....	....	....	....	43182 49616
00	Old Body Style	....	....	....	....	....	....	....	61565 81789	58638 77638	....	43180 <sup>8</sup> 49231 <sup>7</sup> 49616
	4WD, Old Body Style	G63609	61542 81726	58901 77609	....	....	....	G63638	....	....	....	49616
	RWD, Old Body Style	G63489	61544 81668	58489 77489	....	....	....	G63896	....	....	....	49616
95-99	Old Body Style	....	....	....	....	....	....	....	61565 81789	58638 77638	....	43180 <sup>8</sup> 49231 <sup>7</sup>
	4WD, Old Body Style	G63609	61542 81726	58901 77609	....	....	....	G63638	....	....	....	....
	RWD, Old Body Style	G63489	61544 81668	58489 77489	....	....	....	G63896	....	....	....	....

### TAHOE ESTABILIZADORES DE DIRECCIÓN

		Delantero	Trasero
01-05	4WD, Estilo New Body, Exc. Suspensión Z55	6853SE <sup>82</sup>	....
95-00	4WD, Old Body Style	6853SE <sup>82</sup>	....
95-99	RWD	6852SE <sup>82</sup>	....

6 Se recomienda que cuando se reemplacen amortiguadores "quad", los 4 sean de la misma serie.

8 Paquetes en pares

53 Montaje de Strut. Es probable reutilizar algunas partes del E.O.

82 Use kit si está señalado. Vea Ref. C para Botas.



7 Paquetes en pares; kit de mangueras de aire incluido

50 Para proteger la barra del pistón, se recomienda utilizar el kit Bellows No.141242.

80 No requiere soportes para el montaje, instalar sobre montajes de EO Vea Ref. C para Botas.

84 Amortiguador de repuesto para los vehículos con el kit de montaje aftermarket GRC

# AMORTIGUADORES Y STRUTS

Año	Notas de Aplicación										
		Ultra	ProGuard\ Guardian	Max Control\ LTV	Protector de Strut\ Bases de Strut	HiJacker\ Soporte\ Hidráulico	Ultra	ProGuard\ Guardian	Max Control\ LTV	Protector de Strut\ Bases de Strut	HiJacker\ Soporte\ Hidráulico

## CHEVROLET

## CHEVROLET

### TRAILBLAZER

03-09	Todos	↓	G51718	....	....	143241 <sup>53</sup>	....	....	....	....		
	Suspensión de Resorte de Aire Trasera	↓	G51718	....	....	143241 <sup>53</sup>	....	○	G64014	61717	....	....
02-09	Coil(RearSpringType)	↓	G51718	....	....	143241 <sup>53</sup>	....	○	G63842	....	77971	....
02	Todos	↓	....	....	....	143241 <sup>53</sup>	....	....	....	....	....	....
	Suspensión de Resorte de Aire Trasera	↓	....	....	....	143241 <sup>53</sup>	....	○	G64014	61717	....	....

### TRAILBLAZER EXT

02-06	Todos	↓	....	....	....	....	....	○	....	....	77971	....	....
-------	-------	---	------	------	------	------	------	---	------	------	-------	------	------

### UPLANDER

05-09	Exc. Suspensión con Nivelación Neumática	↓	G52025	....	....	....	....	....	....	....	....	....
	FWD	↓	....	....	....	142526 <sup>54</sup>	....	....	....	....	....	....
	FWD; Exc. Suspensión con Nivelación Neumática	↓	....	....	....	....	....	○	G63776	....	....	....
05-08	FWD, Suspensión con Nivelación Neumática; Exc. Suspensión Trasera Independiente	↓	....	....	....	....	....	○	....	....	....	49230 <sup>7</sup>

### VAN 1/2 TON, G / EXPRESS

07-11	Barra de Torsión (Suspensión de Resorte Delantera)	↓	G63893	....	....	....	....	○	G63896	61686 81789	58638 77638	....	43180 <sup>8</sup> 49231 <sup>7</sup>
	RWD, Coil(FrontSpringType)	↓	G63894	....	....	....	....	○	G63896	61686 81789	58638 77638	....	43180 <sup>8</sup> 49231 <sup>7</sup>
03-11	Todos	↓	....	....	....	....	....	○	G63896	61686 81789	58638 77638	....	43180 <sup>8</sup> 49231 <sup>7</sup>
03-06	Barra de Torsión (Suspensión de Resorte Delantera)	↓	G63893	61683	....	....	....	○	G63896	61686 81789	58638 77638	....	43180 <sup>8</sup> 49231 <sup>7</sup>
	RWD, Coil(FrontSpringType)	↓	G63894	61684	....	....	....	○	G63896	61686 81789	58638 77638	....	43180 <sup>8</sup> 49231 <sup>7</sup>
96-02	Todos	↓	G63375 <sup>5</sup>	61555 81713 <sup>5</sup>	77375	....	....	○	G63896	61565 81789	58638 77638	....	43180 <sup>8</sup> 49231 <sup>7</sup>
78-95	Todos	↓	G63357	61517 81108	58357 77357	....	....	○	G63413	61522 81496	58413 77413	....	49212 <sup>7</sup>
71-77	Todos	↓	G63357	61517 81108	58357 77357	....	....	○	G63306	82006	....	....	43093 <sup>8</sup> 49162 <sup>7</sup>
70	Todos	↓	....	....	....	....	....	○	G63306	82006	....	....	43093 <sup>8</sup> 49162 <sup>7</sup>
	Eje Delantero Rígido	↓	....	82062	....	....	....	○	G63306	82006	....	....	43093 <sup>8</sup> 49162 <sup>7</sup>
	Suspensión Delantera Independiente	↓	G63357	61517 81108	58357 77357	....	....	○	G63306	82006	....	....	43093 <sup>8</sup> 49162 <sup>7</sup>
67-69	Todos	↓	....	82062	....	....	....	○	G63306	82006	....	....	43093 <sup>8</sup> 49162 <sup>7</sup>
64-66	Todos	↓	....	82062	....	....	....	○	....	82003	....	....	....

### VAN 1/2 TON, G / EXPRESS ESTABILIZADORES DE DIRECCIÓN

							Delantero	Trasero
70-95	Estabilizador de Dirección Sistema Sencillo						6802SE <sup>84</sup>	....

### VAN 1/2 TON, P SERIES

74-80	Todos	↓	G63355	61525 81039	58355 77355	....	34036 <sup>8</sup>	○	G63366	61649 81174	58366 77662	....	....
73	Todos	↓	G63355	61525 81039	58355 77355	....	34036 <sup>8</sup>	○	G63349	61524 81164	58349 77349	....	43111 <sup>8</sup> 49155 <sup>7</sup>
67-72	Todos	↓	G63355	61525 81039	58355 77355	....	34036 <sup>8</sup> 70164	○	....	82003	....	....	43062 <sup>8</sup> 49107 <sup>7</sup>

5 Use el kit 140719 para reemplazar partes del EO de montaje inferior cuando los pernos se rompan o los tornillos autoroscantes no se puedan utilizar más.

8 Paquetes en pares

54 Kit con Montaje y Rodamiento. Es probable que reutilizar algunas partes del E.O.



7 Paquetes en pares; kit de mangueras de aire incluido

53 Montaje de Strut. Es probable reutilizar algunas partes del E.O.

84 Amortiguador de repuesto para los vehículos con el kit de montaje aftermarket

GRC

# AMORTIGUADORES Y STRUTS

Año	Notas de Aplicación										
		Ultra	ProGuard\ Guardian	Max Control\ LTV	Protector de Strut\ Bases de Strut	HiJacker\ Soporte\ Hidráulico	Ultra	ProGuard\ Guardian	Max Control\ LTV	Protector de Strut\ Bases de Strut	HiJacker\ Soporte\ Hidráulico

## CHEVROLET

## CHEVROLET

### VAN 1/2 TON, P SERIES (cont)

63-66	Todos	○	G63355	61525 81039	58355 77355	....	34036 <sup>6</sup> 70164	○	G63306	82006	....	....	43093 <sup>8</sup> 49162 <sup>7</sup>
62	Todos	○	....	82035	....	....	....	○	....	82086	....	....	....

### VAN 3/4 TON, G / EXPRESS

10-12	Todos	○	....	....	....	....	....	○	G63897	61687	77638	....	....
	Barra de Torsión (Suspensión de Resorte Delantera)	⌋	G63893	61683	....	....	....	⌋	G63897	61687	77638	....	....
	Coil(FrontSpringType)	⌋	G63895	61685	....	....	....	⌋	G63897	61687	77638	....	....
07-09	Todos	○	....	....	....	....	....	○	G63897	61687 81789	58638 77638	....	....
	Barra de Torsión (Suspensión de Resorte Delantera)	⌋	G63893	61683	....	....	....	⌋	G63897	61687 81789	58638 77638	....	....
	Coil(FrontSpringType)	⌋	G63895	61685	....	....	....	⌋	G63897	61687 81789	58638 77638	....	....
03-06	Todos	○	....	....	....	....	....	○	G63897	61687	77638	....	....
	Barra de Torsión (Suspensión de Resorte Delantera)	⌋	G63893	61683	....	....	....	⌋	G63897	61687	77638	....	....
	Coil(FrontSpringType)	⌋	G63895	61685	....	....	....	⌋	G63897	61687	77638	....	....
96-02	Exc. PBV 8600 #	⌋	G63375 <sup>5</sup>	61555 81713 <sup>5</sup>	77375	....	....	⌋	G63638	61565 81789	58638 77638	....	43180 <sup>6</sup> 49231 <sup>7</sup>
78-95	Exc. PBV 8600 #	○	G63357	61517 81108	58357 77357	....	....	○	G63413	61522 81496	58413 77413	....	49212 <sup>7</sup>
71-77	Todos	○	G63357	61517 81108	58357 77357	....	....	○	G63306	82006	....	....	43093 <sup>8</sup> 49162 <sup>7</sup>
70	Todos	○	....	....	58357	....	....	○	G63306	82006	....	....	43093 <sup>8</sup> 49162 <sup>7</sup>
	Eje Delantero Rígido	○	....	82062	58357	....	....	○	G63306	82006	....	....	43093 <sup>8</sup> 49162 <sup>7</sup>
	Suspensión Delantera Independiente	○	G63357	61517 81108	77357 58357	....	....	○	G63306	82006	....	....	43093 <sup>8</sup> 49162 <sup>7</sup>
67-69	Todos	○	....	82062	....	....	....	○	G63306	82006	....	....	43093 <sup>8</sup> 49162 <sup>7</sup>

### VAN 3/4 TON, G / EXPRESS ESTABILIZADORES DE DIRECCIÓN

		Delantero		Trasero	
70-95	Estabilizador de Dirección Sistema Sencillo	6802SE <sup>84</sup>		....	

### VAN 3/4 TON, P SERIES

79-89	Todos	○	G63355	61525 81039	58355 77355	....	34036 <sup>6</sup>	○	G63366	61649 81174	58366 77662	....	....
73-78	Todos	○	G63355	61525 81039	58355 77355	....	34036 <sup>6</sup>	○	G63349	61524 81164	58349 77349	....	43111 <sup>6</sup> 49155 <sup>7</sup>
68-72	Todos	○	G63355	61525 81039	58355 77355	....	34036 <sup>6</sup> 70164	○	G63306	82006	....	....	43093 <sup>8</sup> 49162 <sup>7</sup>
63-72	Todos	⌋	....	....	....	....	70164	⌋	....	....	....	....	....
63-67	Todos	○	....	82047	....	....	70164	○	....	....	....	....	....
61-62	Todos	○	....	82047	....	....	....	⌋	....	82155	....	....	....

### VAN 1 TON, G / EXPRESS

10-12	Todos	○	....	....	....	....	....	○	....	81789	58638 77638	....	....
	Barra de Torsión (Suspensión de Resorte Delantera)	⌋	G63893	....	....	....	....	⌋	....	81789	58638 77638	....	....
	Rodada Trasera Sencilla	⌋	....	....	....	....	....	⌋	G63897	61687 81789	58638 77638	....	....
	Coil(FrontSpringType)	⌋	G63895	61685	....	....	....	....	⌋	....	81789	58638 77638	....
07-09	Todos	○	....	....	....	....	....	○	....	....	77638	....	....
	Barra de Torsión (Suspensión de Resorte Delantera)	⌋	G63893	....	....	....	....	⌋	....	....	77638	....	....

5 Use el kit 140719 para reemplazar partes del EO de montaje inferior cuando los pernos se rompan o los tornillos autoroscantes no se puedan utilizar más.

8 Paquetes en pares



7 Paquetes en pares; kit de mangueras de aire incluido

84 Amortiguador de repuesto para los vehículos con el kit de montaje aftermarket GRC





# AMORTIGUADORES Y STRUTS

Año	Notas de Aplicación										
		Ultra	ProGuard\ Guardian	Max Control\ LTV	Protector de Strut\ Bases de Strut	HiJacker\ Soporte\ Hidráulico	Ultra	ProGuard\ Guardian	Max Control\ LTV	Protector de Strut\ Bases de Strut	HiJacker\ Soporte\ Hidráulico

## CHEVROLET

## CHEVROLET

### VAN 1 TON, P SERIES (cont)

90	5.7L SFI	○	....	....	....	....	42961 70164	○	....	....	....	....	....
89	5.7L OHC, FI	○	....	....	....	....	42961 70164	○	....	....	....	....	42958

## DODGE

## DODGE

### CALIBER

12	Todos	○	....	....	....	....	....	○	....	....	....	143337 <sup>53</sup>	....
07-11	Izquierdo	↓	G52081	....	....	....	....	↓	G51842	....	....	143337 <sup>53</sup>	....
	Derecho	↓	G52082	....	....	....	....	↓	G51842	....	....	143337 <sup>53</sup>	....

### CB-300

70-80	Todos	○	....	....	....	....	70176	○	....	....	....	....	....
-------	-------	---	------	------	------	------	-------	---	------	------	------	------	------

### CHALLENGER

08-10	Todos	↓	....	....	....	....	143369 <sup>53</sup>	↓	....	....	....	143335 <sup>63</sup>	....
78-83	Todos	↓	....	....	....	....	143059 <sup>51</sup>	↓	....	....	....	....	....
70-74	Todos	○	....	82090	....	....	....	○	....	82131	....	....	43096 49106 <sup>7</sup>

### CHARGER

06-10	Todos	↓	....	....	....	....	....	↓	....	....	....	143335 <sup>63</sup>	....
	RWD	↓	....	....	....	....	143369 <sup>53</sup>	↓	....	....	....	143335 <sup>63</sup>	....
	RWD, Izquierdo	↓	G51761	....	....	....	....	↓	....	....	....	143335 <sup>63</sup>	....
	RWD, Izquierdo Modelos Policía	↓	G51947	....	....	....	....	↓	....	....	....	143335 <sup>63</sup>	....
	RWD, Derecho	↓	G51760	....	....	....	....	↓	....	....	....	143335 <sup>63</sup>	....
	RWD, Derecho Modelos Policía	↓	G51948	....	....	....	....	↓	....	....	....	143335 <sup>63</sup>	....
06-09	Exc. Paquete Policía w/Suspensión Nivomat	↓	....	....	....	....	....	↓	G51721	....	....	143335 <sup>63</sup>	....
83-87	Todos	↓	G55507	....	....	....	141578 <sup>54</sup> 143057 <sup>51</sup>	↓	G51047	....	....	142173 <sup>53</sup>	....
77-78	Todos	○	....	81153	....	....	....	○	69703	81338	....	....	43138 <sup>8</sup>
73-76	Todos	○	....	81153	....	....	....	○	....	82131	....	....	43096 <sup>8</sup> 49106 <sup>7</sup>
66-72	Todos	○	....	82090	....	....	....	○	....	82131	....	....	43096 <sup>8</sup> 49106 <sup>7</sup>

### D200 HEAVY DUTY

72-80	Susp. Del. con resortes	○	....	....	....	....	70176	○	....	....	....	....	....
-------	-------------------------	---	------	------	------	------	-------	---	------	------	------	------	------

### D250 HEAVY DUTY

72-93	Susp. Del. con resortes	○	....	....	....	....	70176	○	....	....	....	....	....
-------	-------------------------	---	------	------	------	------	-------	---	------	------	------	------	------

### H-100 DIESEL

08-13	Todos	↓	G64129	....	....	....	....	↓	G64128	....	....	....	....
-------	-------	---	--------	------	------	------	------	---	--------	------	------	------	------

7 Paquetes en pares; kit de mangueras de aire incluido

51 Protectores de Strut.





54 Kit con Montaje y Rodamiento. Es probable que reutilizar algunas partes del E.O.

8 Paquetes en pares

53 Montaje de Strut. Es probable reutilizar algunas partes del E.O.

63 El Kit de Montaje incluye: Aislador Parachoques. Es probable reutilizar algunas partes del E.O.



# AMORTIGUADORES Y STRUTS

Año	Notas de Aplicación										
			Ultra	ProGuard\ Guardian	Max Control\ LTV	Protector de Strut\ Bases de Strut	HiJacker\ Soporte\ Hidráulico		Ultra	ProGuard\ Guardian	Max Control\ LTV





## DODGE

## DODGE





### H100

02-07	2.5L 94 HP		G63909	....	....	....	....		G63949	....	....	....	....
-------	------------	---	--------	------	------	------	------	---	--------	------	------	------	------



### M300

74	Todos		G63605	....	....	....	....		G63183	....	....	....	70175
	H3, M3, M-375 H4, M4		G63605	....	....	....	....		G63183	82065	....	....	70175



### M350

74	Todos		G63605	....	....	....	....		....	....	....	....	....
	H3, M3, M-375 H4, M4		G63605	....	....	....	....		....	82065	....	....	....



### MB-300

81-93	Susp. Del. con resortes		....	....	....	....	70176		....	....	....	....	....
-------	-------------------------	---	------	------	------	------	-------	---	------	------	------	------	------



### MB-350

81-93	Susp. Del. con resortes		....	....	....	....	70176		....	....	....	....	....
-------	-------------------------	---	------	------	------	------	-------	---	------	------	------	------	------



### MB-400

70-80	Todos		....	....	....	....	70176		....	....	....	....	....
-------	-------	---	------	------	------	------	-------	---	------	------	------	------	------

































### PB300 VAN

74-80	Todos		....	....	....	....	70176		....	....	....	....	....
-------	-------	---	------	------	------	------	-------	---	------	------	------	------	------

### PB350 VAN

81-83	Todos		....	....	....	....	70176		....	....	....	....	....
-------	-------	---	------	------	------	------	-------	---	------	------	------	------	------

### PICKUP 1/2 TON, D100 SERIES



91-93	Todos		....	....	....	....	70166		....	....	....	....	70167
	Todos		G63359	61523 <sup>35</sup> 81096 <sup>35</sup>	58359 <sup>35</sup> 77359 <sup>35</sup>	....	34052 <sup>8</sup> 70166		G63353	61526 81091	58353	....	43067 <sup>8</sup> 49149 <sup>7</sup> 70167
89-90	Todos		....	....	....	....	42962 70166		....	....	....	....	70167
	Todos		G63359	61523 <sup>35</sup> 81096 <sup>35</sup>	58359 <sup>35</sup> 77359 <sup>35</sup>	....	34052 <sup>8</sup> 42962 70166		G63353	61526 81091	58353	....	43067 <sup>8</sup> 49149 <sup>7</sup> 70167
	5.9L Turbocharged		....	....	....	....	42962 70166		....	....	....	....	42960 70167
88-90	3.7L 4BBL		....	....	....	....	42962 70166		....	....	....	....	42960 70167
72-88	Todos		....	....	....	....	70166		....	....	....	....	70167
	Todos		G63359	61523 <sup>35</sup> 81096 <sup>35</sup>	58359 <sup>35</sup> 77359 <sup>35</sup>	....	34052 <sup>8</sup> 70166		G63353	61526 81091	58353	....	43067 <sup>8</sup> 49149 <sup>7</sup> 70167
83	5.9L Turbocharged		....	....	....	....	42962 70166		....	....	....	....	70167
82	5.9L TBI		....	....	....	....	42962 70166		....	....	....	....	42960 70167
80	3.7L 4BBL		....	....	....	....	42962 70166		....	....	....	....	42960 70167
	5.9L TBI		....	....	....	....	42962 70166		....	....	....	....	42960 70167
73-74	3.7L 4BBL		....	....	....	....	42962 70166		....	....	....	....	42960 70167
72	3.7L 4BBL		....	....	....	....	42957 70166		....	....	....	....	42957 70167
	Susp. Del. con muelles hasta 1a. Serie 72		....	....	....	....	70166		....	....	....	....	70175 70167
70-71	Todos		....	61523 82046	....	....	....		....	82054	....	....	....

7 Paquetes en pares; kit de mangueras de aire incluido

8 Paquetes en pares

35 Es necesaria abertura en brazo de control para instalar el producto fabricado antes de agosto 1988.

# AMORTIGUADORES Y STRUTS

Año	Notas de Aplicación										
		Ultra	ProGuard\ Guardian	Max Control\ LTV	Protector de Strut\ Bases de Strut	HiJacker\ Soporte\ Hidráulico	Ultra	ProGuard\ Guardian	Max Control\ LTV	Protector de Strut\ Bases de Strut	HiJacker\ Soporte\ Hidráulico

**DODGE**

**DODGE**

## PICKUP 1/2 TON, D100 SERIES (cont)

70-71	3.7L 4BBL	⊕	....	61523 82046	....	....	42957	⊕	....	82054	....	....	42957
	Susp. Del. con muelles hasta 1a. Serie 72	⊕	....	61523 82046	....	....	....	⊕	....	82054	....	....	70175
61-69	Todos	⊕	....	82046	....	....	....	⊕	....	82054	....	....	....
	Susp. Del. con muelles hasta 1a. Serie 72	⊕	....	82046	....	....	....	⊕	....	82054	....	....	70175
60	Todos	⊕	....	....	....	....	....	⊕	....	82054	....	....	....

## PICKUP 1/2 TON, D100 SERIES ESTABILIZADORES DE DIRECCIÓN

		Delantero	Trasero
86-89	Estabilizador de Dirección Sistema Sencillo	6802SE <sup>84</sup>	....
72-79	Estabilizador de Dirección Sistema Sencillo	6802SE <sup>84</sup>	....
60-71	Estabilizador de Dirección Sistema Sencillo c/ Eje de Viga en I	6802SE <sup>84</sup>	....

## PICKUP 1/2 TON, RAM 1500

11-14	Todos	⊕	....	....	....	....	....	⊕	G64044	....	....	....	....
	4WD	⊕	G51856	....	....	....	....	⊕	G64044	....	....	....	....
	RWD	⊕	G64043	....	....	....	....	⊕	G64044	....	....	....	....
09-10	Todos	⊕	....	....	....	....	....	⊕	G64044	....	....	....	....
	4WD	⊕	G51856	....	....	143389 <sup>53</sup>	....	⊕	G64044	....	....	....	....
	RWD	⊕	G64043	....	....	....	....	⊕	G64044	....	....	....	....
06-08	4WD, Mega Cab	⊕	G64009	61712	....	....	....	⊕	....	....	....	....	....
	4WD; Exc. Mega Cab	⊕	G51758	....	....	143324 <sup>53</sup>	....	⊕	G63961	61691 81931	....	....	....
	RWD; Exc. Mega Cab	⊕	G63958	81933	77954	....	....	⊕	G63962	61692	....	....	....
06-07	Exc. Mega Cab	⊕	....	....	....	....	....	⊕	....	....	58412 77412	....	....
02-05	Todos	⊕	....	....	....	....	....	⊕	G63675	....	58412 77412	....	....
	4WD	⊕	G63848	81932	77947	....	....	⊕	G63675	61691 81931	58412 77412	....	....
	RWD	⊕	G63958	81933	77954	....	....	⊕	G63675	61692	58412 77412	....	....
94-01	Todos	⊕	....	....	....	....	....	⊕	G63662	61600 81873	58662 77662	....	43181 <sup>8</sup> 49235 <sup>7</sup>
	4WD	⊕	G63673	61634 81919	58673 77673	....	....	⊕	G63662	61600 81873	58662 77662	....	43181 <sup>8</sup> 49235 <sup>7</sup>
	RWD	⊕	G63661	61599 81928	58661 77661	....	....	⊕	G63662	61600 81873	58662 77662	....	43181 <sup>8</sup> 49235 <sup>7</sup>

## PICKUP 1/2 TON, RAM 1500 ESTABILIZADORES DE DIRECCIÓN

		Delantero	Trasero
00-07	4WD, Con Número de EO 52106909AB, AC, AD	6847SE <sup>82</sup>	....
94-01	RWD, GAS Estabilizador de Dirección para Suspensión con Resortes Helicoidales	6859SE <sup>82</sup>	....
97-99	4WD, Con Número de EO 52039280	6846SE <sup>82</sup>	....
94-97	4WD, Con Número de EO 52038276	6804SE <sup>80</sup>	....

## PICKUP 1/2 TON, W100 SERIES

90-93	Exc. Kit de Levantamiento	⊕	G63183	61632 81825	58183 77183	....	....	⊕	G63389	61633 81342	58389 77389	....	....
81-93	Exc. Kit de Levantamiento	⊕	....	....	....	....	70175	⊕	....	....	....	....	....





7 Paquetes en pares; kit de mangueras de aire incluido  
53 Montaje de Strut. Es probable reutilizar algunas partes del E.O.  
82 Use kit si está señalado. Vea Ref. C para Botas.

8 Paquetes en pares  
80 No requiere soportes para el montaje, instalar sobre montajes de EO Vea Ref. C para Botas.

84 Amortiguador de repuesto para los vehículos con el kit de montaje aftermarket GRC

Texto en Negritas - Número de Parte Nuevo / Futuro













# AMORTIGUADORES Y STRUTS

Año	Notas de Aplicación										
			Ultra	ProGuard/ Guardian	Max Control/ LTV	Protector de Strut/ Bases de Strut	HiJacker/ Soporte/ Hidráulico		Ultra	ProGuard/ Guardian	Max Control/ LTV

## DODGE

## DODGE















































### PICKUP 1/2 TON, W100 SERIES (cont)

86-89	Exc. Kit de Levantamiento		G63183	61632 81825	58183 77183	....	70175		G63389	61633 81342	58389 77389	....	....
81-85	Exc. Kit de Levantamiento		G63183	61632 81825	58183 77183	....	....		G63389	61633 81342	58389 77389	....	....
75-80	Todos		....	....	....	....	70175		....	....	....	....	....
72-80	Todos		G63183	61632 81825	58183 77183	....	70175		G63389	61633 81342	58389 77389	....	....
61-71	Todos		G63183	61632 81825	58183 77183	....	70175		....	82054	....	....	....
60	Todos		....	82065	....	....	....		....	82054	....	....	....

### PICKUP 1/2 TON, W100 SERIES ESTABILIZADORES DE DIRECCIÓN

		Delantero	Trasero
90-93	Estabilizador de Dirección Sistema Sencillo	6802SE <sup>84</sup>	....
60-89	Estabilizador de Dirección Sistema Sencillo	6803SE <sup>84</sup>	....
60-86	Estabilizador de Dirección Sistema Dual; Exc. Servofreno montado del lado del Eje del Conductor	6802SE <sup>84</sup>	....

### PICKUP 3/4 TON, D200 SERIES

90-93	Todos		....	....	....	....	70166		G63353	61526 81091	58353	....	43067 <sup>8</sup> 49149 <sup>7</sup> 70167
	Exc. Paquete HD		G63359 <sup>35</sup>	61523 <sup>35</sup> 81096 <sup>35</sup>	58359 <sup>35</sup> 77359 <sup>35</sup>	....	34052 <sup>8</sup> 70166		....	....	....	....	70167
82-93	Paquete HD		G63360 <sup>35</sup>	61650 81834	58360	....	70166		....	....	....	....	70167
72-93	Todos		....	....	....	....	70166		....	....	....	....	70167
90	5.9L Turbocharged, Diesel		....	....	....	....	42962 70166		....	....	....	....	42960 70167
82-89	Todos		....	....	77359 <sup>35</sup>	....	70166		G63353	61526 81091	58353	....	43067 <sup>8</sup> 49149 <sup>7</sup> 70167
	Exc. Paquete HD		G63359 <sup>35</sup>	61523 <sup>35</sup> 81096 <sup>35</sup>	58359 <sup>35</sup>	....	34052 <sup>8</sup> 70166		....	....	....	....	70167
89	5.9L Turbocharged		....	....	....	....	42962 70166		....	....	....	....	70167
	5.9L Turbocharged, Diesel		....	....	....	....	70166		....	....	....	....	42960 70167
81	Todos		....	....	....	....	70166		G63353	61526 81091	58353	....	43067 <sup>8</sup> 70167
	Exc. Paquete HD		G63359 <sup>35</sup>	61523 <sup>35</sup> 81096 <sup>35</sup>	58359 <sup>35</sup> 77359 <sup>35</sup>	....	34052 <sup>8</sup> 70166		....	....	....	....	49149 <sup>7</sup> 70167
	Paquete HD		G63360 <sup>35</sup>	....	....	....	70166		....	....	....	....	70167
	165.0(WheelBase) Paquete HD		....	61650 81834	58360	....	70166		....	....	....	....	70167
77-80	Paquete HD		G63360 <sup>35</sup>	61650	58360	....	70166		....	....	....	....	70167
	165.0(WheelBase) Paquete HD		....	81834	....	....	70166		....	....	....	....	70167
72-80	Todos		....	....	....	....	70166		G63353	61526 81091	58353	....	43067 <sup>8</sup> 49149 <sup>7</sup> 70167
	Exc. Paquete HD		G63359 <sup>35</sup>	61523 <sup>35</sup> 81096 <sup>35</sup>	58359 <sup>35</sup> 77359 <sup>35</sup>	....	34052 <sup>8</sup> 70166		....	....	....	....	70167
75-76	Paquete HD		G63360 <sup>35</sup>	....	....	....	70166		....	....	....	....	70167
	165.0(WheelBase) Paquete HD		....	61650 81834	58360	....	70166		....	....	....	....	70167
72-74	Paquete HD		G63360 <sup>35</sup>	61650 81834	58360	....	70166		....	....	....	....	70167
61-71	Todos		....	82046	....	....	....		....	82054	....	....	....
	Susp. Del. con muelles hasta 1a. Serie 72		....	82046	....	....	....		....	82054	....	....	70175
60	Todos		....	....	....	....	....		....	82054	....	....	....



7 Paquetes en pares; kit de mangueras de aire incluido

35 Es necesaria abertura en brazo de control para instalar el producto fabricado antes de agosto 1988.

8 Paquetes en pares

84 Amortiguador de repuesto para los vehículos con el kit de montaje aftermarket GRC

# AMORTIGUADORES Y STRUTS

Año	Notas de Aplicación										
		Ultra	ProGuard\ Guardian	Max Control\ LTV	Protector de Strut\ Bases de Strut	HiJacker\ Soporte\ Hidráulico	Ultra	ProGuard\ Guardian	Max Control\ LTV	Protector de Strut\ Bases de Strut	HiJacker\ Soporte\ Hidráulico

**DODGE**

**DODGE**

## PICKUP 3/4 TON, D200 SERIES ESTABILIZADORES DE DIRECCIÓN

		Delantero	Trasero
73-93	Estabilizador de Dirección Sistema Sencillo	6802SE <sup>84</sup>	....
60-71	Estabilizador de Dirección Sistema Sencillo c/ Eje de Viga en I	6802SE <sup>84</sup>	....

## PICKUP 3/4 TON, RAM 2500

Año	Modelo	Ultra	ProGuard\ Guardian	Max Control\ LTV	Protector de Strut\ Bases de Strut	HiJacker\ Soporte\ Hidráulico	Ultra	ProGuard\ Guardian	Max Control\ LTV	Protector de Strut\ Bases de Strut	HiJacker\ Soporte\ Hidráulico
11-12	Todos	....	....	....	....	....	....	....	77950	....	....
	4WD	....	....	....	....	....	G64013	61716	77950	....	....
	RWD	....	....	77949	....	....	....	....	77950	....	....
09-10	4WD	....	....	77948	....	....	....	61716	77950	....	....
07-10	RWD, Standard Cab Pickup	....	....	....	....	....	G63970	....	77950	....	....
03-10	Todos	....	....	....	....	....	....	....	77950	....	....
	4WD, PBV 8800	....	....	....	....	....	G64013	....	77950	....	....
	RWD	....	....	77949	....	....	....	....	77950	....	....
05-08	4WD	G64011	61714	77948	....	....	....	61716	77950	....	....
03-06	RWD, Crew Cab Pickup	....	....	....	....	....	G63971	61710	77950	....	....
	RWD, Standard Cab Pickup	....	....	....	....	....	G63970	61709	77950	....	....
03-04	4WD	....	....	77948	....	....	....	61716	77950	....	....
03	4WD, GAS Exc. PBV 8600 #	....	....	....	....	....	G63662	61600 81873	77950	....	....
99-02	4WD, Exc. PBV 8600 #	....	81919	....	....	....	....	....	....	....	....
94-02	4WD, DIESEL PBV 8800	G63674	61635	58674 77674	....	....	G63675	61642 81921	58675 77675	....	....
	4WD, GAS Exc. PBV 8600 #	G63673	61634	58673 77673	....	....	G63662	61600 81873	58662 77662	....	49235 <sup>7</sup>
	RWD	G63661	61599 81928	58661 77661	....	....	G63662	61600 81873	58662 77662	....	43181 <sup>8</sup> 49235 <sup>7</sup>
95-96	4WD, CNG Exc. PBV 8600 #	G63673	61634	58673	....	....	G63662	61600 81873	58662 77662	....	49235 <sup>7</sup>
94-95	4WD, Exc. PBV 8600 #	....	81919	....	....	....	....	....	....	....	....

## PICKUP 3/4 TON, RAM 2500 ESTABILIZADORES DE DIRECCIÓN

		Delantero	Trasero
00-07	4WD, Con Número de EO 52106909AB, AC, AD	6847SE <sup>82</sup>	....
94-02	RWD, GAS Estabilizador de Dirección para Suspensión con Resortes Helicoidales	6859SE <sup>82</sup>	....
97-99	4WD, Con Número de EO 52039280	6846SE <sup>82</sup>	....
94-97	4WD, Con Número de EO 52038276	6804SE <sup>80</sup>	....

## PICKUP 3/4 TON, W200 SERIES

Año	Modelo	Ultra	ProGuard\ Guardian	Max Control\ LTV	Protector de Strut\ Bases de Strut	HiJacker\ Soporte\ Hidráulico	Ultra	ProGuard\ Guardian	Max Control\ LTV	Protector de Strut\ Bases de Strut	HiJacker\ Soporte\ Hidráulico
81-93	Standard Cab Pickup Exc. Kit de Levantamiento	G63183	61632 81825	58183 77183	....	70175	G63389	61633 81342	58389 77389	....	....
89-90	Van 5.9L 4BBL	....	....	....	....	42957	....	....	....	....	....
85-87	3.7L 4BBL	....	....	....	....	42957	....	....	....	....	....
75-80	Todos	....	....	....	....	70175	....	....	....	....	....
72-80	Todos	G63183	61632 81825	58183 77183	....	70175	G63389	61633 81342	58389 77389	....	....
69-71	Todos	G63183	61632 81825	58183 77183	....	70175	....	82054	....	....	....
61-67	Todos	G63183	61632 81825	58183 77183	....	70175	....	82054	....	....	....
60	Todos	....	82065	....	....	....	....	82054	....	....	....

7 Paquetes en pares; kit de mangueras de aire incluido





80 No requiere soportes para el montaje, instalar sobre montajes de EO Vea Ref. C para Botas.

84 Amortiguador de repuesto para los vehículos con el kit de montaje aftermarket GRC

8 Paquetes en pares

82 Use kit si está señalado. Vea Ref. C para Botas.

# AMORTIGUADORES Y STRUTS

Año	Notas de Aplicación										
			Ultra	ProGuard\ Guardian	Max Control\ LTV	Protector de Strut\ Bases de Strut	HiJacker\ Soporte\ Hidráulico		Ultra	ProGuard\ Guardian	Max Control\ LTV











































## DODGE

## DODGE

### PICKUP 3/4 TON, W200 SERIES ESTABILIZADORES DE DIRECCIÓN

		Delantero	Trasero
90-93	Estabilizador de Dirección Sistema Sencillo	6802SE <sup>84</sup>	....
69-89	Estabilizador de Dirección Sistema Sencillo	6803SE <sup>84</sup>	....
60-86	Estabilizador de Dirección Sistema Dual; Exc. Servofreno montado del lado del Eje del Conductor	6802SE <sup>84</sup>	....
60-67	Estabilizador de Dirección Sistema Sencillo	6803SE <sup>84</sup>	....











### PICKUP 1 TON, D300 SERIES

91-93	Todos		....	....	58360	....	70166		G63353	61526 81091	58353	....	43067 <sup>8</sup> 49149 <sup>7</sup>
	Paquete HD		G63360	61650 81834	....	....	70166		....	....	....	....	....
81-93	Todos		....	....	....	....	70166		....	....	....	....	....
	Susp. Del. c/ Resortes		....	....	....	....	70176 70166		....	....	....	....	....
	susp. Del. C/resortes		....	....	....	....	70166		....	....	....	....	70167
89-90	3.7L 4BBL		....	....	....	....	42963 70166		....	....	....	....	42960
90	Todos		G63360	....	58360	....	70166		G63353	61526 81091	58353	....	43067 <sup>8</sup> 49149 <sup>7</sup>
	Paquete HD		....	61650 81834	....	....	70166		....	....	....	....	....
81-89	Todos		....	....	58360	....	70166		G63353	61526 81091	58353	....	43067 <sup>8</sup> 49149 <sup>7</sup>
	Paquete HD		G63360	61650 81834	....	....	70166		....	....	....	....	....
88	3.7L 4BBL		....	....	....	....	42963 70166		....	....	....	....	....
81-87	3.7L 4BBL		....	....	....	....	42963 70166		....	....	....	....	42960
81-83	5.9L Turbocharged, Diesel		....	....	....	....	42963 70166		....	....	....	....	42960
82	5.5L MFI		....	....	....	....	42963 70166		....	....	....	....	....
72-80	Todos		....	....	58360	....	....		G63353	61526 81091	58353	....	43067 <sup>8</sup> 49149 <sup>7</sup>
	Paquete HD		G63360	61650 81834	58360	....	....		G63353	61526 81091	58353	....	43067 <sup>8</sup> 49149 <sup>7</sup>
	susp. Del. C/resortes		....	....	58360	....	....		G63353	61526 81091	58353	....	70167 43067 <sup>8</sup> 49149 <sup>7</sup>
80	3.7L 4BBL		....	....	58360	....	42963		G63353	61526 81091	58353	....	43067 <sup>8</sup> 49149 <sup>7</sup>
	5.2L MFI		....	....	58360	....	42963		G63353	61526 81091	58353	....	43067 <sup>8</sup> 49149 <sup>7</sup>
	5.9L Turbocharged, Diesel		....	....	58360	....	42963		G63353	61526 81091	58353	....	43067 <sup>8</sup> 49149 <sup>7</sup>
61-71	Todos		....	82046	....	....	....		....	82065	....	....	....

### PICKUP 1 TON, D300 SERIES ESTABILIZADORES DE DIRECCIÓN

		Delantero	Trasero
75-93	Estabilizador de Dirección Sistema Sencillo	6802SE <sup>84</sup>	....
72-74	Estabilizador de Dirección Sistema Sencillo c/ Suspensión Delantera de Resorte Helicoidal	6802SE <sup>84</sup>	....
60-71	Estabilizador de Dirección Sistema Sencillo c/ Eje de Viga en I	6802SE <sup>84</sup>	....

### PICKUP 1 TON, RAM 3500



11-12	Todos		....	....	....	....	....		....	....	77950	....	....
03-12	RWD		....	....	77949	....	....		....	....	77950	....	....
07-10	RWD, Standard Cab Pickup		....	....	....	....	....		G63970	....	77950	....	....
03-10	Todos		....	....	....	....	....		....	....	77950	....	....
	4WD		....	....	77948	....	....		....	....	77950	....	....

7 Paquetes en pares; kit de mangueras de aire incluido

8 Paquetes en pares

84 Amortiguador de repuesto para los vehículos con el kit de montaje aftermarket GRC

# AMORTIGUADORES Y STRUTS

Año	Notas de Aplicación										
		Ultra	ProGuard\ Guardian	Max Control\ LTV	Protector de Strut\ Bases de Strut	HiJacker\ Soporte\ Hidráulico	Ultra	ProGuard\ Guardian	Max Control\ LTV	Protector de Strut\ Bases de Strut	HiJacker\ Soporte\ Hidráulico

**DODGE**

**DODGE**

## PICKUP 1 TON, RAM 3500 (cont)

03-07	RWD, Crew Cab Pickup	.....	.....	.....	.....	.....	○ G63971	61710	77950	.....	.....
03-06	RWD, Standard Cab Pickup	.....	.....	.....	.....	.....	○ G63970	61709	77950	.....	.....
95-02	4WD	○ G63674	61635	58674 77674	.....	.....	○ G63675	61642 81921	58675 77675	.....	.....
	RWD, Eje Delantero Rígido	○ G63674	61635	58674 77674	.....	.....	○ G63675	61642 81921	58675 77675	.....	.....
	RWD, Exc. Eje Delantero Rígido	○ G63661	61599 81928	58661 77661	.....	.....	○ G63662	61600 81873	58662 77662	.....	43181 <sup>8</sup> 49235 <sup>7</sup>
94	Todos	.....	81096	.....	.....	.....	.....	.....	.....	.....	.....
	4WD	○ G63674	61635 81096	58674 77674	.....	.....	○ G63675	61642 81921	58675 77675	.....	.....
	RWD, Eje Delantero Rígido	○ G63674	61635 81096	58674 77674	.....	.....	○ G63675	61642 81921	58675 77675	.....	.....
	RWD, Exc. Eje Delantero Rígido	○ G63661	61599 81928 81096	58661 77661	.....	.....	○ G63662	61600 81873	58662 77662	.....	43181 <sup>8</sup> 49235 <sup>7</sup>

## PICKUP 1 TON, RAM 3500 ESTABILIZADORES DE DIRECCIÓN

		Delantero	Trasero
00-07	4WD, Con Número de EO 52106909AB, AC, AD	6847SE <sup>82</sup>	.....
	RWD, Con Número de EO 52106909AB, AC, AD w/Eje Delantero Rígido	6847SE <sup>82</sup>	.....
94-02	RWD, GAS Estabilizador de Dirección para Suspensión con Resortes Helicoidales	6859SE <sup>82</sup>	.....
97-99	4WD, Con Número de EO 52039280	6846SE <sup>82</sup>	.....
94-97	4WD, Con Número de EO 52038276	6804SE <sup>80</sup>	.....

## PICKUP 1 TON, W300 SERIES

81-93	Exc. Suspensión Quad y Kit de Levantamiento	○ G63183	61632 81825	58183 77183	.....	.....	○ G63389	61633 81342	58389 77389	.....	.....
	Exc. Suspensión Quad y Kit de Levantamiento	.....	.....	.....	.....	70175	.....	.....	.....	.....	.....
72-80	Todos	○ G63183	61632 81825	58183 77183	.....	70175	○ G63389	61633 81342	58389 77389	.....	.....
68-71	Todos	○ G63183	61632 81825	58183	.....	70175	○ G63183	61632 81825	58183 77183	.....	70175
64-67	Todos	○ G63183	61632 81825	58183 77183	.....	70175	○ G63183	61632 81825	58183 77183	.....	70175
61-63	Todos	○ G63183	61632 81825	58183 77183	.....	70175	○ G63183	61632 81825	58183	.....	70175

## PICKUP 1 TON, W300 SERIES ESTABILIZADORES DE DIRECCIÓN

		Delantero	Trasero
90-93	Estabilizador de Dirección Sistema Sencillo	6802SE <sup>84</sup>	.....
60-89	Estabilizador de Dirección Sistema Sencillo	6803SE <sup>84</sup>	.....
60-86	Estabilizador de Dirección Sistema Dual; Exc. Servofreno montado del lado del Eje del Conductor	6802SE <sup>84</sup>	.....

## PICKUP, RAM 50

87-93	4WD	.....	61529	77418	.....	.....	○ G63419	61532 81538	.....	.....	.....
	RWD	○ G63950	61556 81714	.....	.....	.....	○ G63907	61500 81147	77907	.....	43048 <sup>8</sup> 49310 <sup>7</sup>
	RWD	.....	.....	.....	.....	.....	.....	.....	.....	.....	70163
83-86	Todos	.....	.....	.....	.....	.....	.....	.....	.....	.....	70163
	Todos	.....	61556 81714	.....	.....	.....	○ G63907	61500	77907	.....	43048 <sup>8</sup> 49310 <sup>7</sup> 70163
	RWD	○ G63950	.....	.....	.....	.....	.....	81147	.....	.....	70163

7 Paquetes en pares; kit de mangueras de aire incluido

8 Paquetes en pares

80 No requiere soportes para el montaje, instalar sobre montajes de EO Vea Ref. C para Botas.





82 Use kit si está señalado. Vea Ref. C para Botas.

84 Amortiguador de repuesto para los vehículos con el kit de montaje aftermarket

GRC



# AMORTIGUADORES Y STRUTS

Año	Notas de Aplicación										
			Ultra	ProGuard\ Guardian	Max Control\ LTV	Protector de Strut\ Bases de Strut	HiJacker\ Soporte\ Hidráulico		Ultra	ProGuard\ Guardian	Max Control\ LTV









## DODGE

## DODGE

### PICKUP, RAM 50 ESTABILIZADORES DE DIRECCIÓN

		Delantero	Trasero
83-93	RWD, Estabilizador de Dirección Sistema Sencillo	6802SE <sup>84</sup>	....



### RAIDER

87-89	Todos		G63418	61529	77418	....	....	....	....	....	....		
	Exc. Sport Utility		G63418	61529	77418	....	....		G63492	81318	77492	....	....
	2.6L 4Cyl L		G63418	61529	77418	....	....		....	61506	....	....	....
89	3.0L 6 Cyl V		G63418	61529	77418	....	....		....	61568	....	....	....
	Sport Utility		G63418	61529	77418	....	....		G63604	....	....	....	....



### RAIDER ESTABILIZADORES DE DIRECCIÓN

		Delantero	Trasero
87-89	Estabilizador de Dirección Sistema Sencillo	6802SE <sup>84</sup>	....



### RAM 4000

05-08	Todos		G63674	....	....	....	....		G63675	....	....	....	....
-------	-------	---	--------	------	------	------	------	---	--------	------	------	------	------



### RAM 6500

95-99	Todos		....	61670 81898	....	....	....		....	....	....	....	....
-------	-------	---	------	----------------	------	------	------	---	------	------	------	------	------



### RAM VAN 1500, 2500 Y 3500

99-03	Todos		....	....	....	....	70166		....	....	....	....	....
-------	-------	--	------	------	------	------	-------	--	------	------	------	------	------



































### RAM WAGON

94-98	Todos		....	61668 81896	....	....	....		....	61665 81900	....	....	....
-------	-------	---	------	----------------	------	------	------	---	------	----------------	------	------	------

### RAM WAGON Y VAN

97-01	Todos		....	....	....	....	70166		....	....	....	....	70167
-------	-------	---	------	------	------	------	-------	---	------	------	------	------	-------

### RAMCHARGER

99-01	Todos		....	61599	....	....	....		G63662	61600	....	....	....
95-96	Todos		....	81096	....	....	....		....	....	....	....	....
	RWD		....	61523 81096	....	....	....		....	61526 81091	....	....	....
	RWD		....	81096	....	....	....		....	....	....	....	70167
84-94	5.9L Turbocharged, MFI		....	....	....	....	....		....	....	....	....	42960
94	5.9L 8Cyl (360) Turbocharged, DOHC		....	....	....	....	42963		....	....	....	....	....
	5.9L Turbocharged, FI		....	....	....	....	42962		....	....	....	....	42960
91-93	5.9L Turbocharged, FI		....	....	....	....	....		....	....	....	....	42960
89-93	RWD		G63359	61523 <sup>35</sup> 81096 <sup>35</sup>	58359 <sup>35</sup> 77359 <sup>35</sup>	....	34052 <sup>8</sup>		G63353	61526 81091	58353	....	43067 <sup>8</sup> 49149 <sup>7</sup>
84-93	5.9L 8Cyl V (360)		....	....	....	....	42963		....	....	....	....	....
76-93	4WD		G63183	61632 81825	58183	....	70175		G63389	61633 81342	58389	....	....
88-90	RWD		....	....	....	....	....		....	....	....	....	70167
84-90	5.9L Turbocharged, FI		....	....	....	....	42962		....	....	....	....	42960
76-88	RWD		G63359 <sup>35</sup>	61523 <sup>35</sup> 81096 <sup>35</sup>	58359 <sup>35</sup> 77359 <sup>35</sup>	....	34052 <sup>8</sup>		G63353	61526 81091	58353	....	43067 <sup>8</sup> 49149 <sup>7</sup>
82-83	5.9L Turbocharged, FI		....	....	....	....	42957 42962		....	....	....	....	42960
81	5.9L Turbocharged, DOHC		....	....	....	....	42962		....	....	....	....	....
	5.9L Turbocharged, FI		....	....	....	....	42957		....	....	....	....	42960



7 Paquetes en pares; kit de mangueras de aire incluido

35 Es necesaria abertura en brazo de control para instalar el producto fabricado antes de agosto 1988.

8 Paquetes en pares

84 Amortiguador de repuesto para los vehículos con el kit de montaje aftermarket GRC

# AMORTIGUADORES Y STRUTS

Año	Notas de Aplicación										
		Ultra	ProGuard\ Guardian	Max Control\ LTV	Protector de Strut\ Bases de Strut	HiJacker\ Soporte\ Hidráulico	Ultra	ProGuard\ Guardian	Max Control\ LTV	Protector de Strut\ Bases de Strut	HiJacker\ Soporte\ Hidráulico

## DODGE

## DODGE

### RAMCHARGER (cont)

80	5.9L Turbocharged, DOHC	⊖	....	....	....	....	42962	⊖	....	....	....	....	42960
	5.9L Turbocharged, FI	⊖	....	....	....	....	42957	⊖	....	....	....	....	....
75	Todos	⊖	....	....	....	....	....	⊖	....	....	58353	....	43067 <sup>6</sup> 49149 <sup>7</sup>
	4WD	⊖	G63183	61632 81825	58183	....	70175	⊖	....	....	58353	....	43067 <sup>6</sup> 49149 <sup>7</sup>
	RWD	⊖	G63359 <sup>35</sup>	61523 <sup>35</sup> 81096 <sup>35</sup>	58359 <sup>35</sup> 77359 <sup>35</sup>	....	34052 <sup>8</sup>	⊖	G63353	61526 81091	58353	....	43067 <sup>6</sup> 49149 <sup>7</sup>
74	Todos	⊖	....	....	58183	....	....	⊖	....	....	58353	....	43067 <sup>6</sup> 49149 <sup>7</sup>
	4WD	⊖	G63183	81825	58183	....	....	⊖	....	....	58353	....	43067 <sup>6</sup> 49149 <sup>7</sup>
	4WD	⊖	....	61632	58183	....	70175	⊖	....	....	58353	....	43067 <sup>6</sup> 49149 <sup>7</sup>
	RWD	⊖	....	....	58183	....	....	⊖	G63353	61526 81091	58353	....	43067 <sup>6</sup> 49149 <sup>7</sup>

### RAMCHARGER ESTABILIZADORES DE DIRECCIÓN

		Delantero	Trasero
87-93	RWD, Estabilizador de Dirección Sistema Sencillo	6802SE <sup>84</sup>	....
75-93	4WD, Estabilizador de Dirección Sistema Sencillo	6803SE <sup>84</sup>	....
74-86	Estabilizador de Dirección Sistema Dual; Exc. Servofreno montado del lado del Eje del Conductor	6802SE <sup>84</sup>	....
74	Estabilizador de Dirección Sistema Sencillo	6803SE <sup>84</sup>	....

### SPRINTER 2500

03-06	Todos	⊖	G56778	....	....	....	....	⊖	....	....	....	....	....
	Exc. Doble Rodada Trasera	⊖	G56778	....	....	....	....	⊖	G63918	....	....	....	....

### SPRINTER 3500

03-06	Todos	⊖	G56778	....	....	....	....	⊖	....	....	....	....	....
	Doble Rodada Trasera	⊖	G56778	....	....	....	....	⊖	G63919	....	....	....	....
	Exc. Doble Rodada Trasera	⊖	G56778	....	....	....	....	⊖	G63918	....	....	....	....

### VAN 1/2 TON, A / B SERIES / RAM

99-03	109.3(WheelBase) Exc. PBV 7000#	⊖	G63359 <sup>35</sup>	61523 <sup>35</sup> 81096 <sup>35</sup>	58359 <sup>35</sup> 77359 <sup>35</sup>	....	34052 <sup>8</sup>	⊖	G63413	61522 <sup>5</sup> 81496	58413 77413	....	43085 <sup>6</sup> 49212 <sup>7</sup>
82-98	109.6(WheelBase) Exc. PBV 7000#	⊖	G63359 <sup>35</sup>	61523 <sup>35</sup> 81096 <sup>35</sup>	58359 <sup>35</sup> 77359 <sup>35</sup>	....	34052 <sup>8</sup>	⊖	G63413	61522 <sup>5</sup> 81496	58413 77413	....	43085 <sup>6</sup> 49212 <sup>7</sup>
81	109.6(WheelBase) Exc. PBV 7000#	⊖	G63359 <sup>35</sup>	61523 <sup>35</sup> 81096 <sup>35</sup>	58359 <sup>35</sup> 77359 <sup>35</sup>	....	....	⊖	G63413	61522 <sup>5</sup> 81496	58413 77413	....	43085 <sup>6</sup>
71-80	Todos	⊖	....	61523 <sup>35</sup> 81096 <sup>35</sup>	58359 <sup>35</sup> 77359 <sup>35</sup>	....	34052 <sup>8</sup>	⊖	G63413	61522 <sup>5</sup> 81496	58413 77413	....	43085 <sup>6</sup> 49212 <sup>7</sup>
	Exc. Eje Delantero 4000#	⊖	G63359 <sup>35</sup>	61523 <sup>35</sup> 81096 <sup>35</sup>	58359 <sup>35</sup> 77359 <sup>35</sup>	....	34052 <sup>8</sup>	⊖	G63413	61522 <sup>5</sup> 81496	58413 77413	....	43085 <sup>6</sup> 49212 <sup>7</sup>

### VAN 1/2 TON, A / B SERIES / RAM ESTABILIZADORES DE DIRECCIÓN

		Delantero	Trasero
71-87	Estabilizador de Dirección Sistema Sencillo	6803SE <sup>84</sup>	....
71	Estabilizador de Dirección Sistema Sencillo c/ Eje de Viga en I	6802SE <sup>84</sup>	....

### VAN 3/4 TON, A / B SERIES / RAM

93-03	Todos	⊖	G63359 <sup>35</sup>	61523 <sup>35</sup> 81096 <sup>35</sup>	58359 <sup>35</sup> 77359 <sup>35</sup>	....	34052 <sup>8</sup>	⊖	G63413	61522 <sup>5</sup> 81496	58413 77413	....	43085 <sup>6</sup> 49212 <sup>7</sup>
92	Todos	⊖	G63359	61523 <sup>35</sup> 81096 <sup>35</sup>	58359 <sup>35</sup> 77359 <sup>35</sup>	....	34052 <sup>8</sup>	⊖	G63413	61522 <sup>5</sup> 81496	58413 77413	....	43085 <sup>6</sup> 49212 <sup>7</sup>
81-91	Todos	⊖	G63359 <sup>35</sup>	61523 <sup>35</sup> 81096 <sup>35</sup>	58359 <sup>35</sup> 77359 <sup>35</sup>	....	34052 <sup>8</sup>	⊖	G63413	61522 <sup>5</sup> 81496	58413 77413	....	43085 <sup>6</sup> 49212 <sup>7</sup>

6 Se recomienda que cuando se reemplacen amortiguadores "quad", los 4 sean de la misma serie.

8 Paquetes en pares





84 Amortiguador de repuesto para los vehículos con el kit de montaje aftermarket

GRC

7 Paquetes en pares; kit de mangueras de aire incluido

35 Es necesaria abertura en brazo de control para instalar el producto fabricado antes de agosto 1988.





# AMORTIGUADORES Y STRUTS

Año	Notas de Aplicación										
			Ultra	ProGuard\ Guardian	Max Control\ LTV	Protector de Strut\ Bases de Strut	HiJacker\ Soporte\ Hidráulico		Ultra	ProGuard\ Guardian	Max Control\ LTV

## DODGE

## DODGE























### VAN 3/4 TON, A / B SERIES / RAM (cont)

71-80	Todos		....	61523 <sup>35</sup> 81096 <sup>35</sup>	58359 <sup>35</sup> 77359 <sup>35</sup>	....	34052 <sup>8</sup>		G63413	61522 <sup>6</sup> 81496	58413 77413	....	43085 <sup>9</sup> 49212 <sup>7</sup>
	Exc. Eje Delantero 4000#		G63359 <sup>35</sup>	61523 <sup>35</sup> 81096 <sup>35</sup>	58359 <sup>35</sup> 77359 <sup>35</sup>	....	34052 <sup>8</sup>		G63413	61522 <sup>6</sup> 81496	58413 77413	....	43085 <sup>9</sup> 49212 <sup>7</sup>

### VAN 3/4 TON, A / B SERIES / RAM ESTABILIZADORES DE DIRECCIÓN

		Delantero	Trasero
80-87	Estabilizador de Dirección Sistema Sencillo	6803SE <sup>84</sup>	....
78-79	Van Charger Special	6803SE <sup>84</sup>	....
71-77	Estabilizador de Dirección Sistema Sencillo	6803SE <sup>84</sup>	....
71	Estabilizador de Dirección Sistema Sencillo c/ Eje de Viga en I	6802SE <sup>84</sup>	....























### VAN 1 TON, A / B SERIES / RAM

99-03	Todos		G63359 <sup>35</sup>	61523 <sup>35</sup> 81096 <sup>35</sup>	58359 <sup>35</sup> 77359 <sup>35</sup>	....	34052 <sup>8</sup>		G63413	61522 <sup>6</sup> 81496	58413 77413	....	43085 <sup>9</sup> 49212 <sup>7</sup>
	Exc. Eje Delantero 4000#		G63359 <sup>35</sup>	61523 <sup>35</sup> 81096 <sup>35</sup>	58359 <sup>35</sup> 77359 <sup>35</sup>	....	34052 <sup>8</sup>		G63413	61522 <sup>6</sup> 81496	58413 77413	....	43085 <sup>9</sup> 49212 <sup>7</sup>
94	Todos		....	....	....	....	....		....	61522 <sup>6</sup> 81496	58413	....	43085 <sup>9</sup> 49212 <sup>7</sup>
	Exc. Eje Delantero 4000#		G63359 <sup>35</sup>	61523 <sup>35</sup> 81096 <sup>35</sup>	58359 <sup>35</sup> 77359 <sup>35</sup>	....	34052 <sup>8</sup>		G63413	61522 <sup>6</sup> 81496	77413 58413	....	43085 <sup>9</sup> 49212 <sup>7</sup>
72-93	Todos		....	....	....	....	70176		....	....	....	....	....
	Todos		....	....	....	....	70176		G63413	61522 <sup>6</sup> 81496	58413 77413	....	43085 <sup>9</sup> 49212 <sup>7</sup>
	Con Eje Delantero 4000#		G63360	61650 81834	58360	....	70176		....	....	....	....	....
	Exc. Eje Delantero 4000#		G63359 <sup>35</sup>	61523 <sup>35</sup> 81096 <sup>35</sup>	58359 <sup>35</sup> 77359 <sup>35</sup>	....	34052 <sup>8</sup> 70176		....	....	....	....	....
71	Todos		....	....	....	....	....		G63413	61522 <sup>6</sup> 81496	58413 77413	....	43085 <sup>9</sup> 49212 <sup>7</sup>
	Con Eje Delantero 4000#		G63360	61650 81834	58360	....	....		G63413	61522 <sup>6</sup> 81496	58413 77413	....	43085 <sup>9</sup> 49212 <sup>7</sup>
	Exc. Eje Delantero 4000#		G63359 <sup>35</sup>	61523 <sup>35</sup> 81096 <sup>35</sup>	58359 <sup>35</sup> 77359 <sup>35</sup>	....	34052 <sup>8</sup>		G63413	61522 <sup>6</sup> 81496	58413 77413	....	43085 <sup>9</sup> 49212 <sup>7</sup>

### VAN 1 TON, A / B SERIES / RAM ESTABILIZADORES DE DIRECCIÓN

		Delantero	Trasero
71-87	Estabilizador de Dirección Sistema Sencillo	6803SE <sup>84</sup>	....
71	Estabilizador de Dirección Sistema Sencillo c/ Eje de Viga en I	6802SE <sup>84</sup>	....

### VAN, CB300

78-80	Todos		....	....	....	....	....		G63413	61522 <sup>6</sup> 81496	58413	....	43085 <sup>9</sup> 49212 <sup>7</sup>
	Con Eje Delantero 4000#		G63360	61650 81834	....	....	....		G63413	61522 <sup>6</sup> 81496	58413	....	43085 <sup>9</sup> 49212 <sup>7</sup>
	Exc. Eje Delantero 4000#		G63359 <sup>35</sup>	61523 <sup>35</sup> 81096 <sup>35</sup>	58359 <sup>35</sup> 77359 <sup>35</sup>	....	34052 <sup>8</sup>		G63413	61522 <sup>6</sup> 81496	58413	....	43085 <sup>9</sup> 49212 <sup>7</sup>
	PBV arriba de 8300#		....	....	58360	....	....		G63413	61522 <sup>6</sup> 81496	77413 58413	....	43085 <sup>9</sup> 49212 <sup>7</sup>
77	Todos		....	....	....	....	....		G63413	61522 <sup>6</sup> 81496	58413	....	43085 <sup>9</sup>
	Con Eje Delantero 4000#		G63360	61650 81834	....	....	....		G63413	61522 <sup>6</sup> 81496	58413	....	43085 <sup>9</sup>
	Exc. Eje Delantero 4000#		G63359 <sup>35</sup>	61523 <sup>35</sup> 81096 <sup>35</sup>	77359 <sup>35</sup>	....	....		G63413	61522 <sup>6</sup> 81496	58413	....	43085 <sup>9</sup>
	Hasta PBV 8300#		....	....	58359 <sup>35</sup>	....	34052 <sup>8</sup>		G63413	61522 <sup>6</sup> 81496	58413	....	43085 <sup>9</sup>
	PBV arriba de 8300#		....	....	58360	....	....		G63413	61522 <sup>6</sup> 81496	77413 58413	....	49212 <sup>7</sup> 43085 <sup>9</sup>
75-76	Todos		....	....	....	....	....		G63413	61522 <sup>6</sup> 81496	58413	....	43085 <sup>9</sup> 49212 <sup>7</sup>
	Con Eje Delantero 4000#		G63360	61650 81834	....	....	....		G63413	61522 <sup>6</sup> 81496	58413	....	43085 <sup>9</sup> 49212 <sup>7</sup>

6 Se recomienda que cuando se reemplacen amortiguadores "quad", los 4 sean de la misma serie.



8 Paquetes en pares

84 Amortiguador de repuesto para los vehículos con el kit de montaje aftermarket GRC

7 Paquetes en pares; kit de mangueras de aire incluido

35 Es necesaria abertura en brazo de control para instalar el producto fabricado antes de agosto 1988.

# AMORTIGUADORES Y STRUTS

Año	Notas de Aplicación										
		Ultra	ProGuard\ Guardian	Max Control\ LTV	Protector de Strut\ Bases de Strut	HiJacker\ Soporte\ Hidráulico	Ultra	ProGuard\ Guardian	Max Control\ LTV	Protector de Strut\ Bases de Strut	HiJacker\ Soporte\ Hidráulico

## DODGE

## DODGE

### VAN, CB300 (cont)

75-76	Exc. Eje Delantero 4000#	⊥ ⊙	G63359 <sup>35</sup>	61523 <sup>35</sup> 81096 <sup>35</sup>	77359 <sup>35</sup>	....	....	⊥ ⊙	G63413	61522 <sup>5</sup> 81496	58413	....	43085 <sup>5</sup> 49212 <sup>7</sup>
	Hasta PBV 8300#	⊥ ⊙	....	....	58359 <sup>35</sup>	....	34052 <sup>2</sup>	⊥ ⊙	G63413	61522 <sup>5</sup> 81496	58413	....	43085 <sup>5</sup> 49212 <sup>7</sup>
	PBV arriba de 8300#	⊥ ⊙	....	....	58360	....	....	⊥ ⊙	G63413	61522 <sup>5</sup> 81496	77413 58413	....	43085 <sup>5</sup> 49212 <sup>7</sup>
74	Todos	⊥ ⊙	....	....	....	....	....	⊥ ⊙	G63413	61522 <sup>5</sup> 81496	58413	....	43085 <sup>5</sup>
	Con Eje Delantero 4000#	⊥ ⊙	G63360	61650 81834	....	....	....	⊥ ⊙	G63413	61522 <sup>5</sup> 81496	58413	....	43085 <sup>5</sup>
	Exc. Eje Delantero 4000#	⊥ ⊙	G63359 <sup>35</sup>	61523 <sup>35</sup> 81096 <sup>35</sup>	77359 <sup>35</sup>	....	....	⊥ ⊙	G63413	61522 <sup>5</sup> 81496	58413	....	43085 <sup>5</sup>
	Hasta PBV 8300#	⊥ ⊙	....	....	58359 <sup>35</sup>	....	34052 <sup>2</sup>	⊥ ⊙	G63413	61522 <sup>5</sup> 81496	58413	....	43085 <sup>5</sup>
	PBV arriba de 8300#	⊥ ⊙	....	....	58360	....	....	⊥ ⊙	G63413	61522 <sup>5</sup> 81496	77413 58413	....	49212 <sup>7</sup> 43085 <sup>5</sup>

## FORD

## FORD

### AEROSTAR

90-97	Todos	⊥ ⊙	....	....	....	....	....	⊥ ⊙	G63502	61557 81727	....	....	49221 <sup>7</sup>
	4WD, AWD	⊥ ⊙	G63621	61569 81826	....	....	....	⊥ ⊙	G63502	61557 81727	....	....	49221 <sup>7</sup>
	RWD	⊥ ⊙	G63457	61540 81582	....	....	....	⊥ ⊙	G63502	61557 81727	....	....	49221 <sup>7</sup>
89	RWD	⊥ ⊙	G63457	61540 81582	....	....	....	⊥ ⊙	G63502	61557 81727	....	....	49221 <sup>7</sup>
86-88	RWD	⊥ ⊙	G63457	61540 81582	....	....	....	⊥ ⊙	G63490	61541 81583	....	....	....

### B100

79-81	5L 8Cyl (302) FI	⊥ ⊙	G63500	61553	....	....	42971	⊥ ⊙	....	61518 81242	....	....	....
	5L FI	⊥ ⊙	....	....	....	....	42971	⊥ ⊙	....	....	....	....	....
79	4.7L 8Cyl (289) 4WD; MFI	⊥ ⊙	G63500	61553	....	....	42971	⊥ ⊙	....	61518 81242	....	....	....
	4.7L MFI	⊥ ⊙	....	....	....	....	42971	⊥ ⊙	....	....	....	....	....
73-74	Todos	⊥ ⊙	....	....	....	....	42971	⊥ ⊙	....	....	....	....	....
	4.7L 8Cyl (289) 4WD; MFI	⊥ ⊙	G63500	61553	....	....	42971	⊥ ⊙	....	61519 81484	....	....	....
	5.0L FI	⊥ ⊙	....	....	....	....	42971	⊥ ⊙	....	....	....	....	....
74	5L 8Cyl (302) FI	⊥ ⊙	G63500	61553	....	....	42971	⊥ ⊙	....	61519 81242	....	....	....
73	5L 8Cyl (302) FI	⊥ ⊙	G63500	61553	....	....	42971	⊥ ⊙	....	61519 81484	....	....	....

### B150

83-85	3.8L 6Cyl (232) RWD; 4BBL	⊥ ⊙	G63414	61520 81490	....	....	42967	⊥ ⊙	G63409	61518 81710	....	....	42966
82-85	5L 8Cyl (302) FI	⊥ ⊙	G63414	61520 81490	....	....	42967	⊥ ⊙	G63409	61518 81710	....	....	42966
82	3.8L 6Cyl (232) RWD; 4BBL	⊥ ⊙	G63414	61553 81490	....	....	42967	⊥ ⊙	G63409	61518 81710	....	....	42966
75-78	4.7L 8Cyl (289) 4WD; MFI	⊥ ⊙	G63500	61553	....	....	42971	⊥ ⊙	....	61518 81242	....	....	....
	4WD; 4.7 L & 5L FI	⊥ ⊙	....	81694	....	....	....	⊥ ⊙	....	....	....	....	....
	5L 8Cyl (302) FI	⊥ ⊙	G63500	61553	....	....	42971	⊥ ⊙	....	61518 81242	....	....	....

### B200





92	5L 8Cyl (302) FI	⊥ ⊙	G63414	61520 81490	....	....	42967	⊥ ⊙	....	61547 81082	....	....	....
----	------------------	--------	--------	----------------	------	------	-------	--------	------	----------------	------	------	------

6 Se recomienda que cuando se reemplacen amortiguadores "quad", los 4 sean de la misma serie.

8 Paquetes en pares

7 Paquetes en pares; kit de mangueras de aire incluido  
35 Es necesaria abertura en brazo de control para instalar el producto fabricado antes de agosto 1988.



# AMORTIGUADORES Y STRUTS

Año	Notas de Aplicación										
			Ultra	ProGuard\ Guardian	Max Control\ LTV	Protector de Strut\ Bases de Strut	HiJacker\ Soporte\ Hidráulico		Ultra	ProGuard\ Guardian	Max Control\ LTV







































## FORD

## FORD

### B200 (cont)

85-91	5L 8Cyl (302) FI		G63386	61521 81394	....	....	42965		....	81285	....	....	....
-------	------------------	---	--------	----------------	------	------	-------	---	------	-------	------	------	------



### BRONCO

97	Todos		G63414	61520 81490	....	....	....		....	61554	....	....	....
	2.9L 2BBL		G63414	61520 81490	....	....	42967		....	61554	....	....	42966
80-96	Con o sin Suspensión Quad detrás del Eje Delantero; Exc. Kit de Levantamiento		G63414 <sup>6</sup>	61520 <sup>6</sup> 81490	58414 <sup>6</sup> 77414 <sup>6</sup>	....	34057 <sup>8</sup>		....	....	....	....	....
	Exc. Kit de Levantamiento		....	....	....	....	....		G63409	61554 81710	58409 77409 <sup>6</sup>	....	43142 <sup>8</sup> 49197 <sup>7</sup>
	Suspensión Quad adelante del Eje Delantero; Exc. Kit de Levantamiento		G63410 <sup>6</sup>	61546 <sup>6</sup>	58410 <sup>6</sup> 77410 <sup>6</sup>	....	....		....	....	....	....	....
80-88	Kit de Levantamiento de 3-4"		....	....	....	....	....		G63441 <sup>50</sup>	....	....	....	....
80-86	Kit de Levantamiento de 3-4", Suspensión Quad adelante del Eje Delantero		G63446 <sup>6</sup>	....	....	....	....		....	....	....	....	....
	Kit de Levantamiento de 3-4", Suspensión Quad detrás del Eje Delantero		G63445 <sup>6</sup>	....	....	....	....		....	....	....	....	....
78-79	Exc. Kit de Levantamiento		....	....	....	....	....		G63377	61519 81484	58377 77377	....	43058 <sup>8</sup> 49127 <sup>7</sup>
	Izquierdo Kit de Levantamiento de 3 1/2-4" Exc. Suspensión Quad		G63447	....	....	....	....		G63441 <sup>50</sup>	....	....	....	....
	Derecho Kit de Levantamiento de 3 1/2-4" Exc. Suspensión Quad		G63445	....	....	....	....		G63441 <sup>50</sup>	....	....	....	....
	Suspensión Quad adelante del Eje Delantero; Exc. Kit de Levantamiento		....	61551 <sup>6</sup>	....	....	....		....	....	....	....	....
	Suspensión Quad Amortiguador Largo; Exc. Kit de Levantamiento		G63511 <sup>6</sup>	....	....	....	....		....	....	....	....	....
	Suspensión Quad; detrás del Eje Delantero; Exc. Kit de Levantamiento		G63396 <sup>6</sup>	61521 <sup>6</sup> 81394	....	....	....		....	....	....	....	....
67-77	Desde Serie #830001; Exc. Kit de Levantamiento		G63386	61521 <sup>6</sup> 81394	58386	....	34058 <sup>8</sup>		G63377	61519 81484	58377 77377	....	43058 <sup>8</sup> 49127 <sup>7</sup>
66-77	Kit de Levantamiento de 4-5"		G63445	....	....	....	....		G63441 <sup>50</sup>	....	....	....	....
66	Desde Serie #830001; Exc. Kit de Levantamiento		....	61521 <sup>6</sup>	58386	....	34058 <sup>8</sup>		G63377	61519 81484	58377 77377	....	43058 <sup>8</sup>
	Exc. Kit de Levantamiento		G63386	81394	....	....	....		....	....	....	....	....
	Toda la serie #830000		....	....	....	....	....		G63350	61518 81242	58350	....	43099 <sup>6</sup> 49173 <sup>7</sup>

### BRONCO ESTABILIZADORES DE DIRECCIÓN

		Delantero	Trasero
92-96	Estabilizador de Dirección Sistema Sencillo	6802SE <sup>84</sup>	....
80-91	Todos	6802SE <sup>84</sup>	....
78-79	Estabilizador de Dirección Sistema Dual; Exc. Barra Estabilizadora	6802SE <sup>84</sup>	....
71-79	Todos	14016	....
	Estabilizador de Dirección Sistema Sencillo	6803SE <sup>84</sup>	....
70	Estabilizador de Dirección Sistema Sencillo	6803SE <sup>84</sup>	....
68-69	Estabilizador de Dirección Sistema Sencillo	6804SE <sup>80</sup>	....
67	Todos	14016	....
	Estabilizador de Dirección Sistema Sencillo	6804SE <sup>80</sup>	....
66	Estabilizador de Dirección Sistema Sencillo	6804SE <sup>80</sup>	....

### BRONCO II

90	Todos		G63614	61561 81744	58929 77614	....	....		G63525	61559 81730	77525	....	49223 <sup>7</sup>
----	-------	---	--------	----------------	----------------	------	------	---	--------	----------------	-------	------	--------------------

6 Se recomienda que cuando se reemplacen amortiguadores "quad", los 4 sean de la misma serie.

8 Paquetes en pares

80 No requiere soportes para el montaje, instalar sobre montajes de EO Vea Ref. C para Botas.



7 Paquetes en pares; kit de mangueras de aire incluido

50 Para proteger la barra del pistón, se recomienda utilizar el kit Bellows No. 141242.

84 Amortiguador de repuesto para los vehículos con el kit de montaje aftermarket

GRC

# AMORTIGUADORES Y STRUTS

Año	Notas de Aplicación										
		Ultra	ProGuard\ Guardian	Max Control\ LTV	Protector de Strut\ Bases de Strut	HiJacker\ Soporte\ Hidráulico	Ultra	ProGuard\ Guardian	Max Control\ LTV	Protector de Strut\ Bases de Strut	HiJacker\ Soporte\ Hidráulico

## FORD

## FORD

### BRONCO II (cont)

89	Fab. desde 2/89; Vehículos con perno de 12mm en montaje inferior trasero	.....	.....	77414 <sup>6</sup>	.....	.....	○ G63525	61559 81730	77525	.....	49223 <sup>7</sup>
	Fab. hasta 2/89; Vehículos con perno 10mm & 12mm en montaje inferior trasero	○ G63414	61520 <sup>6</sup> 81490	.....	.....	34057 <sup>8</sup>	○ G63427	61533 81539	.....	.....	43165 <sup>8</sup> 49207 <sup>7</sup>
84-88	Con Perno de 10mm en Montaje Inferior Trasero	○ G63414	61520 <sup>6</sup> 81490	77414 <sup>6</sup>	.....	34057 <sup>8</sup>	○ G63427	61533 81539	.....	.....	43165 <sup>8</sup> 49207 <sup>7</sup>

### BRONCO II ESTABILIZADORES DE DIRECCIÓN

		Delantero	Trasero
84-90	Estabilizador de Dirección Sistema Sencillo	6802SE <sup>84</sup>	.....

### CROWN VICTORIA

10-11	Police Interceptor	↑ G51888	.....	.....	143356 <sup>53</sup> 143357 <sup>68</sup>	.....	.....	.....	.....	.....	
07-11	Todos	↑	.....	.....	143356 <sup>53</sup> 143357 <sup>68</sup>	.....	.....	.....	.....	.....	
	Exc. Modelos Policía y Taxi	↑ G51887	.....	.....	143356 <sup>53</sup> 143357 <sup>68</sup>	.....	○ 69575	.....	.....	.....	
07-10	Modelos Policía y Taxi	↑	.....	.....	143356 <sup>53</sup> 143357 <sup>68</sup>	.....	○ 69574	.....	77955	.....	
09	Fab. hasta 12/05; Modelos Policía y Taxi	↑ G51888	.....	.....	143356 <sup>53</sup> 143357 <sup>68</sup>	.....	.....	.....	.....	.....	
07-08	Police Interceptor	↑ G51888	.....	.....	143356 <sup>53</sup> 143357 <sup>68</sup>	.....	.....	.....	.....	.....	
03-06	Todos	↑	.....	.....	143356 <sup>53</sup>	.....	.....	.....	.....	.....	
	Exc. Modelos Policía y Taxi	↑ G51887	.....	.....	143357 <sup>68</sup> 143356 <sup>53</sup>	.....	○ 69575	.....	.....	.....	
	Modelos Policía y Taxi	↑	.....	.....	143356 <sup>53</sup>	.....	○ 69574	.....	77955	.....	
	Police Interceptor	↑ G51888	.....	.....	143356 <sup>53</sup>	.....	.....	.....	.....	.....	
93-02	Modelos Policía y Taxi	○ G63375 <sup>5</sup>	61555 81713 <sup>5</sup>	77375	.....	.....	○ 69606	81495	.....	.....	43140 <sup>8</sup> 49205 <sup>7</sup>
92-02	Todos	○ 69675 <sup>5</sup>	.....	.....	.....	.....	○ 69606	81495	.....	.....	43140 <sup>8</sup> 49205 <sup>7</sup>
	Exc. Sistema de Autonivelación NIVOMAT	○ 69675 <sup>5</sup>	.....	.....	.....	34073 <sup>8</sup>	○ 69606	81495	.....	.....	43140 <sup>8</sup> 49205 <sup>7</sup>
	Exc. Modelos Policía y Taxi	○ 69675 <sup>5</sup>	81446	.....	.....	.....	○ 69606	81495	.....	.....	43140 <sup>8</sup> 49205 <sup>7</sup>

### E-550 ECONOLINE SUPER DUTY

02	Todos	.....	.....	.....	.....	.....	○	61655	.....	.....	.....
----	-------	-------	-------	-------	-------	-------	---	-------	-------	-------	-------

### E-550 SUPER DUTY

03	Todos	.....	.....	.....	.....	.....	○	61655	.....	.....	.....
----	-------	-------	-------	-------	-------	-------	---	-------	-------	-------	-------

### ECONOLINE

61-67	Todos	○ G63492	61506 81318	77492	.....	.....	○ G63299	82007	.....	.....	.....
-------	-------	----------	----------------	-------	-------	-------	----------	-------	-------	-------	-------

### ECONOLINE VAN ESTABILIZADORES DE DIRECCIÓN

		Delantero	Trasero
61-67	Van	6802SE <sup>84</sup>	.....

### ECONOLINE WAGON

99-02	4.2L 6Cyl (256) 4WD; 2BBL	○ G63622	.....	.....	.....	.....	○	61646 81828	.....	.....	.....
-------	---------------------------	----------	-------	-------	-------	-------	---	----------------	-------	-------	-------

5 Use el kit 140719 para reemplazar partes del EO de montaje inferior cuando los pernos se rompan o los tornillos autoroscantes no se puedan utilizar más.

7 Paquetes en pares; kit de mangueras de aire incluido

53 Montaje de Strut. Es probable reutilizar algunas partes del E.O.





84 Amortiguador de repuesto para los vehículos con el kit de montaje aftermarket GRC

6 Se recomienda que cuando se reemplacen amortiguadores "quad", los 4 sean de la misma serie.

8 Paquetes en pares

68 Kit de Accesorios de Montaje. Aislador de Goma del Asiento de Resorte. Es probable reutilizar algunas partes del E.O.



# AMORTIGUADORES Y STRUTS

Año	Notas de Aplicación										
			Ultra	ProGuard\ Guardian	Max Control\ LTV	Protector de Strut\ Bases de Strut	HiJacker\ Soporte\ Hidráulico		Ultra	ProGuard\ Guardian	Max Control\ LTV

















## FORD

## FORD





### ECONOLINE WAGON (cont)

99-02	5L 8Cyl (305) FI		G63622	....	....	....	....		....	61646 81828	....	....	....
-------	------------------	---	--------	------	------	------	------	---	------	----------------	------	------	------

### ESCAPE

12	Izquierdo		G56601	....	....	....	....		....	....	....	....	....
	Derecho		G56568	....	....	....	....		....	....	....	....	....
09-11	Izquierdo		G56601	....	....	143253 <sup>53</sup>	....		G64047	....	....	....	....
	Derecho		G56568	....	....	143253 <sup>53</sup>	....		G64047	....	....	....	....
08	Izquierdo		G56601	....	....	143253 <sup>53</sup>	....		69900 G64047	....	....	....	....
	Derecho		G56568	....	....	143253 <sup>53</sup>	....		69900 G64047	....	....	....	....
01-07	Izquierdo		G56601	....	....	143253 <sup>53</sup>	....		69900 G63862	....	....	....	....
	Derecho		G56568	....	....	143253 <sup>53</sup>	....		69900 G63862	....	....	....	....























### EXCURSION

00-05	4WD		G63809	....	77809	....	....		G63837	....	77837	....	....
	RWD		G63614	....	77614	....	....		G63607	....	77607	....	....

### EXCURSION ESTABILIZADORES DE DIRECCIÓN

										Delantero	Trasero	
00-05	4WD, Con Amortiguador de EO										6854SE <sup>80</sup>	....



### EXPEDITION

10-12	RWD		....	....	....	143389 143424 <sup>53</sup>	....		....	....	....	143393	....
07-12	Coil(RearSpringType) Exc. Suspensión de Aire		G51860	....	....	....	....		G51861	....	....	....	....
07-09	RWD		....	....	RWD	143376 143389	....		....	....	....	143393	....
03-06	Todos		....	....	....	....	....		G51729	....	....	143317 <sup>53</sup>	....
	Exc. Suspensión de Aire		....	....	....	143244 <sup>53</sup>	....		G51729	....	....	143317 <sup>53</sup>	....
	4WD		G51720	....	....	....	....		G51729	....	....	143317 <sup>53</sup>	....
	RWD		G51719	....	....	....	....		G51729	....	....	143317 <sup>53</sup>	....
97-02	Todos		....	....	....	....	....		G63717	61614	58717 77717	....	....
	4WD, Exc. Nivelación Nuemática Delantera		G63716	61613 81914	58716 77716	....	....		G63717	61614	58717 77717	....	....
	RWD, Exc. Nivelación Nuemática Delantera		G63714	61611 81912	58714 77714	....	....		G63717	61614	58717 77717	....	....
96	4.6L 8Cyl (281) 4WD; 2BBL		G63714	....	....	....	....		....	....	....	....	....

### EXPEDITION ESTABILIZADORES DE DIRECCIÓN

										Delantero	Trasero	
97-02	4WD, Barra de Torsion(FrontSpringType)										6861SE <sup>82</sup>	....

### EXPLORER

06-10	Todos		G56838	....	....	143330 <sup>53</sup> 143360 <sup>53</sup>	....		G56839	....	....	143361 <sup>53</sup> 143362 <sup>70</sup>	....
-------	-------	---	--------	------	------	--	------	---	--------	------	------	--	------

53 Montaje de Strut. Es probable reutilizar algunas partes del E.O.



80 No requiere soportes para el montaje, instalar sobre montajes de EO Vea Ref. C para Botas.

Texto en Negritas - Número de Parte Nuevo / Futuro

70 Kit Buje y Camisa. Algunos accesorios del Equipo Original podrían ser necesitados

82 Use kit si está señalado. Vea Ref. C para Botas.



















# AMORTIGUADORES Y STRUTS

Año	Notas de Aplicación										
		Ultra	ProGuard\ Guardian	Max Control\ LTV	Protector de Strut\ Bases de Strut	HiJacker\ Soporte\ Hidráulico	Ultra	ProGuard\ Guardian	Max Control\ LTV	Protector de Strut\ Bases de Strut	HiJacker\ Soporte\ Hidráulico

FORD

FORD





## EXPLORER (cont)

04-05	Exc. Todos los Modelos Sport & Sport Trac		G51723	....	....	143318 <sup>53</sup>	....		G51724	....	....	143319 <sup>53</sup>	....
02-05	Todos		....	....	....	143318 <sup>53</sup>	....		....	....	....	143319 <sup>53</sup>	....
02-03	Exc. Todos los Modelos Sport & Sport Trac		G51722	....	....	143318 <sup>53</sup>	....		G51724	....	....	143319 <sup>53</sup>	....
99-01	Exc. Suspensión Electrónica Ajustable		....	61623 81893	....	....	....		....	....	....	....	43171 <sup>8</sup> 49232 <sup>7</sup>
95-01	Exc. Suspensión de Aire		G63678	....	77678	....	....		G63679	61624 81890	77679	....	....
98	Todos		G63678	....	....	....	....		G63679	61624 81890	....	....	....
	Exc. Suspensión Electrónica Ajustable		G63678	61623 81893	....	....	....		G63679	61624 81890	....	....	43171 <sup>8</sup> 49232 <sup>7</sup>
95-97	Exc. Suspensión Electrónica Ajustable		....	61623 81893	....	....	....		....	....	....	....	43171 <sup>8</sup> 49232 <sup>7</sup>
91-94	Todos		G63608	61591 81744	58929 77608	....	34076 <sup>8</sup>		G63607	61590 81823	77607	....	43172 <sup>8</sup> 49225 <sup>7</sup>















### EXPLORER ESTABILIZADORES DE DIRECCIÓN

		Delantero	Trasero
91-94	Todos	6802SE <sup>84</sup>	....

## EXPLORER SPORT TRAC

07-10	Todos		G52205	....	....	....	....		G52206	....	....	....	....
01-05	Todos		G63678	61623 81893	77678	....	....		G63679	61624 81890	77679	....	43171 <sup>8</sup> 49232 <sup>7</sup>



















## F SERIES

57-59	Todos		....	81270	....	....	....		....	....	....	....	....
	F-100, F-250		....	81270	....	....	....		....	82123	....	....	....
55	Todos		G63299	....	....	....	....		....	....	....	....	....
	F-100		G63299	....	....	....	....		G63405	61500 81147	77405	....	43048 <sup>8</sup> 49310 <sup>7</sup>
	F250		G63299	....	....	....	....		....	81676	....	....	....
53-54	Todos		G63299	....	....	....	....		....	81676	....	....	....
48-52	F-1, F-2 & F-3		G63405	61500 81147	77405	....	....		G63299	81676	....	....	....

### F SERIES ESTABILIZADORES DE DIRECCIÓN

		Delantero	Trasero
57-59	Estabilizador de Dirección Sistema Sencillo c/ Eje de Viga en I	6802SE <sup>84</sup>	....
59	Estabilizador de Dirección Sistema Sencillo F-250, F-350 sin Power Steering	6803SE <sup>84</sup>	....
50-55	Estabilizador de Dirección Sistema Sencillo c/ Eje de Viga en I	6802SE <sup>84</sup>	....

## F-200

88-90	5.8L 8Cyl (351) SOHC; FI		G63455	61520 81821	....	....	42967		G63409	81710 61614	....	....	42966
	RWD 5.8L 8Cyl (351) SOHC; FI		G63414	....	....	....	....		....	61614	....	....	....
87-90	5L 8Cyl (302) FI		G63455	61520 81821	....	....	42967		G63409	81710 61614	....	....	42966
86-90	Todos		....	....	....	....	....		....	61614	....	....	....
	8Cyl SFI		....	81490	....	....	....		....	61530 61614	....	....	....
	RWD 5L 8Cyl (302) FI		G63414	....	....	....	....		....	61614	....	....	....
86-87	RWD 5.8L 8Cyl (351) SFI		G63414	....	....	....	....		....	61614	....	....	....
87	5.8L 8Cyl (351) SFI		....	61520	....	....	42967		....	61614	....	....	....
	5.8L 8Cyl (351) SOHC; EFI		....	....	....	....	....		....	81710 61614	....	....	42966

7 Paquetes en pares; kit de mangueras de aire incluido





53 Montaje de Strut. Es probable reutilizar algunas partes del E.O.

8 Paquetes en pares

84 Amortiguador de repuesto para los vehículos con el kit de montaje aftermarket GRC















# AMORTIGUADORES Y STRUTS

Año	Notas de Aplicación										
			Ultra	ProGuard\ Guardian	Max Control\ LTV	Protector de Strut\ Bases de Strut	HiJacker\ Soporte\ Hidráulico		Ultra	ProGuard\ Guardian	Max Control\ LTV



## FORD

## FORD



### F-200 (cont)

87	5.8L 8Cyl (351) SOHC; FI		G63455	81821	....	....	....		G63409	81710 61614	....	....	....	42966
86	4WD 5.8L 8Cyl (351) SOHC; FI		G63416	....	....	....	....		....	61614	....	....	....	....
	4WD 5L 8Cyl (302) FI		G63416	....	....	....	....		....	61614	....	....	....	....
	5.8L 8Cyl (351) SFI		....	61520	....	....	42967		....	81710 61614	....	....	....	42966
	5.8L 8Cyl (351) SOHC; FI		....	....	....	....	42967		G63409	81710 61614	....	....	....	42966
	5L 8Cyl (302) FI		....	61520	....	....	42967		G63409	81710 61614	....	....	....	42966

### F-600

94-98	Todos		....	....	....	....	....		....	61669 81897	....	....	....	....
-------	-------	---	------	------	------	------	------	---	------	----------------	------	------	------	------



### F-700

94-98	Todos		....	61671	....	....	....		....	61672	....	....	....	....
-------	-------	---	------	-------	------	------	------	---	------	-------	------	------	------	------

### F59 ESTABILIZADORES DE DIRECCIÓN

							Delantero		Trasero	
89-91	Estabilizador de Dirección Sistema Sencillo, Superduty Motorhome						6802SE <sup>84</sup>		....	







### LTD / COUNTRY SEDAN / COUNTRY SQUIRE / CROWN VICTORIA

87-91	Todos		69675 <sup>5</sup>	81446	....	....	34073 <sup>8</sup>		69606	81495	....	....	....	43140 <sup>8</sup> 49205 <sup>7</sup>
-------	-------	---	--------------------	-------	------	------	--------------------	---	-------	-------	------	------	------	--

### MOTORHOME CHASSIS / F53 ESTABILIZADORES DE DIRECCIÓN

							Delantero		Trasero	
89-91	Estabilizador de Dirección Sistema Sencillo Motorhome						6802SE <sup>84</sup>		....	





















### PICKUP 1/2 TON, F SUPERDUTY

93-97	Fab. desde 2/93		G63692	....	....	....	....		G63409	61554 81710	58409 77409 <sup>6</sup>	....	....	....
90-97	Todos		....	....	....	....	....		G63409	61554 81710	58409 77409 <sup>6</sup>	....	....	....
90-93	Fab. hasta 2/93		G63617	....	58617	....	....		G63409	61554 81710	58409 77409 <sup>6</sup>	....	....	....

### PICKUP 1/2 TON, F SUPERDUTY ESTABILIZADORES DE DIRECCIÓN

							Delantero		Trasero	
93-97	Con Amortiguador de EO						6857SE <sup>82</sup>		....	
90-92	Todos						6802SE <sup>84</sup>		....	

### PICKUP 1/2 TON, F-100

80-83	RWD		G63414	61520 81490	58414 77414	....	34057 <sup>8</sup>		G63409	61554 81710	58409 77409	....	....	43142 <sup>8</sup> 49197 <sup>7</sup>
79	Exc. Kit de Levantamiento		G63386	....	....	....	....		....	....	....	....	....	....
	Kit de Levantamiento de 3-4" Exc. Suspensión Quad		G63445 <sup>50</sup>	....	....	....	....		....	....	....	....	....	....
	4WD; Kit de Levantamiento de 3-4" Exc. Suspensión Quad		....	....	....	....	....		G63447 <sup>50</sup>	....	....	....	....	....
	RWD		....	61521 <sup>6</sup> 81394	58386	....	34058 <sup>8</sup>		G63350	61518 81242	58350	....	....	43099 <sup>8</sup> 49173 <sup>7</sup>
77-78	Kit de Levantamiento de 3-4" Exc. Suspensión Quad		G63445 <sup>50</sup>	....	....	....	....		....	....	....	....	....	42964
	4.7L 8Cyl (289) DOHC, FI		....	....	....	....	42965		....	....	....	....	....	42964
	4.7L 8Cyl (289) DOHC, FI		....	82033	....	....	....		G63377	61519 81484	....	....	....	42964
	4WD; Kit de Levantamiento de 3-4" Exc. Suspensión Quad		....	....	....	....	....		G63447 <sup>50</sup>	....	....	....	....	42964
76-78	Exc. Kit de Levantamiento		G63386	....	....	....	....		....	....	....	....	....	42964

5 Use el kit 140719 para reemplazar partes del EO de montaje inferior cuando los pernos se rompan o los tornillos autoroscantes no se puedan utilizar más.

7 Paquetes en pares; kit de mangueras de aire incluido

50 Para proteger la barra del pistón, se recomienda utilizar el kit Bellows No.141242.





84 Amortiguador de repuesto para los vehículos con el kit de montaje aftermarket GRC

6 Se recomienda que cuando se reemplacen amortiguadores "quad", los 4 sean de la misma serie.

8 Paquetes en pares

82 Use kit si está señalado. Vea Ref. C para Botas.

























































# AMORTIGUADORES Y STRUTS

Año	Notas de Aplicación										
		 Ultra	ProGuard\ Guardian	Max Control\ LTV	Protector de Strut\ Bases de Strut	HiJacker\ Soporte\ Hidráulico	 Ultra	ProGuard\ Guardian	Max Control\ LTV	Protector de Strut\ Bases de Strut	HiJacker\ Soporte\ Hidráulico

FORD

FORD

## PICKUP 1/2 TON, F-100 (cont)

76-78	RWD		....	61521 <sup>6</sup> 81394	58386	....	34058 <sup>8</sup>		G63350	61518 81242	58350	....	43099 <sup>8</sup> 49173 <sup>7</sup> 42964
75-78	Todos		....	....	....	....	....		....	....	....	....	42964
75-76	4WD; Exc. Kit de Levantamiento		....	82033	....	....	....		G63387	81285	....	....	49178 <sup>7</sup> 42964
	4WD; Kit de Levantamiento de 3 1/2-4"		....	....	....	....	....		G63447 <sup>50</sup>	....	....	....	42964
76	4.7L 8Cyl (289) DOHC; FI		....	....	....	....	42965		G63377	61519 81484	....	....	42964
75	Todos		G63386	....	....	....	....		....	....	....	....	42964
	4.7L 8Cyl (289) DOHC, FI		....	....	....	....	42965		....	....	....	....	42964
	4.7L 8Cyl (289) DOHC; FI		....	....	....	....	....		G63377	61519 81484	....	....	42964
	RWD		....	61521 <sup>6</sup> 81394	58386	....	34058 <sup>8</sup>		G63350	61518 81242	58350	....	43099 <sup>8</sup> 49173 <sup>7</sup> 42964
73-74	RWD		G63386	61521 <sup>6</sup> 81394	58386	....	34058 <sup>8</sup>		G63350	61518 81242	58350	....	49173 <sup>7</sup>
71-74	4.7L DOHC, FI		G63386	....	....	....	42965		....	....	....	....	42964
	4WD; Exc. Kit de Levantamiento		G63386	82033	....	....	....		G63387	81285	....	....	49178 <sup>7</sup>
70-74	Todos		G63386	....	....	....	....		....	....	....	....	....
	Exc. Supercab		G63386	....	....	....	....		....	....	....	....	43099 <sup>8</sup>
	4.7L 8Cyl (289) DOHC; FI		G63386	82033	....	....	....		G63377	61519 81484	....	....	....
	4WD; Kit de Levantamiento		G63386	....	....	....	....		G63447 <sup>50</sup>	....	....	....	....
72	Kit de Levantamiento		G63386	....	....	....	....		....	....	....	....	49173 <sup>7</sup>
	RWD		G63386	61521 <sup>6</sup> 81394	58386	....	34058 <sup>8</sup>		G63350	61518 81242	58350	....	....
70-71	4.7L DOHC, EFI		G63386	....	....	....	42965		....	....	....	....	42964
	RWD		G63386	61521 <sup>6</sup> 81394	58386	....	34058 <sup>8</sup>		G63350	61518 81242	58350	....	49173 <sup>7</sup>
69-71	4.7L 8Cyl (289) DOHC; EFI		G63386	....	....	....	....		G63377	61519 81484	....	....	....
70	4.7L DOHC, FI		G63386	....	....	....	....		....	....	....	....	42964
	4WD; Exc. Kit de Levantamiento		G63386	82033	....	....	....		G63387	....	....	....	49178 <sup>7</sup>
66-69	4.7L 8Cyl (289) DOHC; FI		....	82033	....	....	....		G63377	61519 81484	....	....	....
	4.7L DOHC, FI		....	....	....	....	....		....	....	....	....	42964
	4WD; Exc. Kit de Levantamiento		....	82033	....	....	....		....	....	....	....	....
	RWD		G63386	61521 <sup>6</sup> 81394	58386	....	34058 <sup>8</sup>		G63377	61519 81484 82147	58377 77377	....	43058 <sup>8</sup> 49127 <sup>7</sup>
69	4.7L DOHC, EFI		....	....	....	42965		....	....	....	....	42964	
67-68	4.7L 8Cyl (289) Diesel		....	....	....	....	42965		....	....	....	....	....
	4.7L 8Cyl (289) DIESEL		G63386	....	....	....	....		G63377	61519 81484	....	....	....
	4.7L Diesel		....	....	....	....	....		....	....	....	....	42964
68	4.7L DOHC		....	....	....	....		....	....	....	....	42964	
67	4.7L 8Cyl (289) AWD; Turbocharged; DOHC		....	....	....	....	....		....	61519	....	....	....
66	4.7L 8Cyl (289) AWD; DOHC; FI		G63386	....	....	....	....		G63377	61519	....	....	....
	4.7L 8Cyl (289) AWD; DOHC; SFI		....	....	....	....	....		....	81484	....	....	....



6 Se recomienda que cuando se reemplacen amortiguadores "quad", los 4 sean de la misma serie.

7 Paquetes en pares; kit de mangueras de aire incluido

8 Paquetes en pares

50 Para proteger la barra del pistón, se recomienda utilizar el kit Bellows No.141242.

# AMORTIGUADORES Y STRUTS

Año	Notas de Aplicación										
		Ultra	ProGuard\ Guardian	Max Control\ LTV	Protector de Strut\ Bases de Strut	HiJacker\ Soporte\ Hidráulico	Ultra	ProGuard\ Guardian	Max Control\ LTV	Protector de Strut\ Bases de Strut	HiJacker\ Soporte\ Hidráulico

**FORD**

**FORD**

## PICKUP 1/2 TON, F-100 (cont)

66	4.7L 8Cyl (289) AWD; SOHC; MFI	....	....	....	....	....	....	61519	....	....	....	
	4.7L 8Cyl (289) AWD; Turbocharged; DIESEL	....	....	....	....	....	G63377	....	....	....	....	
	4.7L 8Cyl (289) AWD; Turbocharged; DOHC	....	....	....	....	....	....	81484	....	....	....	
	AWD 4.7L DOHC; FI	I O	....	....	....	....	....	....	....	....	....	
	AWD 4.7L DOHC; MFI	....	....	....	....	....	....	....	....	....	42964	
	AWD 4.7L Turbocharged, Diesel	I O	....	....	....	....	....	....	....	....	....	
	AWD 4.7L Turbocharged, DOHC	....	....	....	....	....	....	....	....	....	42964	
65	Todos	....	....	....	....	....	....	....	....	....	42964	
	4WD a inicios de 1965	O O	....	61500	....	....	....	....	....	....	42964	
	Con Resortes de Hojas Delanteros	....	....	....	....	....	....	81147	....	....	42964	
	Principios de 1965	I T	....	82034	....	....	....	....	....	....	42964	
	4.7L 8Cyl (289) 4WD; TBI	I O	G63386	....	....	....	....	G63377	61519 81484	....	....	42964
	4.7L 8Cyl (289) 4WD; Turbocharged; DIESEL	....	....	....	....	....	....	G63377	61519	....	....	42964
	4.7L 8Cyl (289) AWD; DOHC	....	....	....	....	....	....	....	81484	....	....	42964
	4.7L 8Cyl (289) DOHC; FI	....	....	....	....	....	....	G63405	....	....	....	42964
	4.7L TBI	I O	....	....	....	....	....	....	....	....	....	42964
	4.7L Turbocharged, Diesel	I O	....	....	....	....	....	....	....	....	....	42964
	4WD 4.7L 8Cyl (289) DOHC; FI	I T	G63187	....	....	....	....	....	....	....	....	42964
	4WD, Con Resortes de Hojas Delanteros	I T	G63187	....	....	....	....	....	....	....	....	42964
	4WD; late 1965; Exc. Kit de Levantamiento	O O	....	82033	....	....	....	....	....	....	....	42964
RWD	I O	G63386	61521 <sup>6</sup> 81394	58386	....	34058 <sup>8</sup>	G63377	61519 81484 82147	58377 77377	....	43058 <sup>8</sup> 49127 <sup>7</sup> 42964	
61-64	Todos	....	....	....	....	....	O O	G63405	61500 81147	77405	....	43048 <sup>8</sup> 49310 <sup>7</sup>
	RWD	I T	....	82038	....	....	....	G63405	61500 81147	77405	....	43048 <sup>8</sup> 49310 <sup>7</sup>
60	Todos	I T	....	81270	....	....	....	....	82123	....	....	....
53-55	Exc. Heavy Duty	....	....	....	....	....	....	....	81676	....	....	....

## PICKUP 1/2 TON, F-100 ESTABILIZADORES DE DIRECCIÓN

		Delantero	Trasero
80-83	RWD, Estabilizador de Dirección Sistema Sencillo	6802SE <sup>84</sup>	....
78-79	Estabilizador de Dirección Sistema Dual; Exc. Barra Estabilizadora	6802SE <sup>84</sup>	....
75-79	RWD, Estabilizador de Dirección Sistema Sencillo c/ Eje de Doble Viga en I	6802SE <sup>84</sup>	....
60-79	Estabilizador de Dirección Sistema Sencillo 4WD	6803SE <sup>84</sup>	....
79	Sistema Sencillo 4WD	14016	....
75-78	4WD	14016	....
77	4WD; Estabilizador de Dirección Sistema Dual; Exc. Barra Estabilizadora	6802SE <sup>84</sup>	....
75-76	4WD, Estabilizador de Dirección Sistema Dual; Exc. Barra Estabilizadora	6802SE <sup>84</sup>	....
65-74	RWD; Estabilizador de Dirección Sistema Sencillo; con Ejes Paralelos de Viga en I	6802SE <sup>84</sup>	....
60-64	RWD; Estabilizador de Dirección Sistema Sencillo; con Eje de Viga en I	6802SE <sup>84</sup>	....

## PICKUP 1/2 TON, F-150

14	4WD	....	....	....	....	....	O O	G64079	....	....	....	....
----	-----	------	------	------	------	------	--------	--------	------	------	------	------

6 Se recomienda que cuando se reemplacen amortiguadores "quad", los 4 sean de la misma serie.





8 Paquetes en pares

7 Paquetes en pares; kit de mangueras de aire incluido

84 Amortiguador de repuesto para los vehículos con el kit de montaje aftermarket

GRC

# AMORTIGUADORES Y STRUTS

Año	Notas de Aplicación										
		 Ultra	ProGuard\ Guardian	Max Control\ LTV	Protector de Strut\ Bases de Strut	HiJacker\ Soporte\ Hidráulico	 Ultra	ProGuard\ Guardian	Max Control\ LTV	Protector de Strut\ Bases de Strut	HiJacker\ Soporte\ Hidráulico

FORD

FORD

## PICKUP 1/2 TON, F-150 (cont)

13	4WD	 G51864	....	....	....	....	 G64079	....	....	....	....
	RWD	 G51865	....	....	....	....	....	....	....	....	....
11-12	RWD	 G51865	....	....	<b>143424<sup>53</sup></b>	....	....	....	....	....	....
10-12	Todos	 ....	....	....	<b>143424<sup>53</sup></b>	....	....	....	....	....	....
	4WD	 G51864	....	....	<b>143424<sup>53</sup></b>	....	 G64079	....	....	....	....
10	RWD	 G51865	....	....	<b>143424<sup>53</sup></b>	....	 G63867	....	....	....	....
09	4WD	 G51864	....	....	....	....	 G64079	....	....	....	....
	RWD	 G51865	....	....	143376	....	 G63867	....	....	....	....
05-08	RWD	 ....	....	....	143248 <sup>53</sup>	....	 ....	....	....	....	43183
04-08	Todos	 ....	....	....	143248 <sup>53</sup>	....	....	....	....	....	....
	4WD	 G51704	....	....	143248 <sup>53</sup>	....	 G63867	....	....	....	43184
	RWD; Exc Lightning Model	 G51703	....	....	143248 <sup>53</sup>	....	 G63870	....	....	....	....
04	4WD, Exc. PBV 7700#	 G63716	61613 81914	58716 77716	143248 <sup>53</sup>	....	 G63715	61612 81913	58715 77715	....	....
	RWD	 G63714	....	....	143248 <sup>53</sup>	....	 ....	....	....	....	43183
	RWD; Heritage Model	 ....	61611 81912	58714 77714	143248 <sup>53</sup>	....	 G63778	61638 81892	58778 77778	....	49237 <sup>7</sup>
99-03	RWD	 G63714	61611 81912	58714 77714	....	....	....	....	....	....	....
	RWD; Exc Lightning Model	 ....	....	....	....	....	 G63778	61638 81892	58778 77778	....	49237 <sup>7</sup>
98-03	4WD	 G63716	61613 81914	58716 77716	....	....	....	....	....	....	....
	4WD, Exc. PBV 7700#	 ....	....	....	....	....	 G63715	61612 81913	58715 77715	....	....
00	XLT, RWD	 ....	....	....	....	....	 G63778	....	....	....	....
98	RWD	 ....	61611 81912	58714 77714	....	....	....	....	....	....	....
	RWD; Exc Lightning Model	 G63714	....	....	....	....	 G63778	61638 81892	58778 77778	....	49237 <sup>7</sup>
96-97	Todos	 ....	....	....	....	42967	....	....	....	....	42966
97	4.9L FI	 ....	....	....	....	42967	....	....	....	....	42966
	4WD	 G63716	61613 81914	58716 77716	....	42967	....	....	....	....	42966
	4WD, Exc. PBV 7700#	 ....	....	....	....	42967	 G63715	61612 81913	58715 77715	....	42966
	RWD	 G63714	61611 81912	58714 77714	....	42967	 ....	....	....	....	42966
	RWD; Exc Lightning Model	 ....	....	....	....	42967	 G63778	61638 81892	58778 77778	....	49237 <sup>7</sup> 42966
96	4WD, Con o sin Suspensión Quad detrás del Eje Delantero; Exc. Kit de Levantamiento	 G63414 <sup>6</sup>	61520 <sup>6</sup> 81490	58414 <sup>6</sup> 77414 <sup>6</sup>	....	34057 <sup>9</sup> 42967	....	....	....	....	42966
	4WD, Exc. Kit de Levantamiento	 ....	....	....	....	42967	 G63461	61530 81510	58461 77461	....	49217 <sup>7</sup> 42966





6 Se recomienda que cuando se reemplacen amortiguadores "quad", los 4 sean de la 7 Paquetes en pares; kit de mangueras de aire incluido misma serie.

53 Montaje de Strut. Es probable reutilizar algunas partes del E.O.

8 Paquetes en pares

Texto en Negritas - Número de Parte Nuevo / Futuro

























































# AMORTIGUADORES Y STRUTS

Año	Notas de Aplicación										
			Ultra	ProGuard\ Guardian	Max Control\ LTV	Protector de Strut\ Bases de Strut	HiJacker\ Soporte\ Hidráulico		Ultra	ProGuard\ Guardian	Max Control\ LTV

**FORD**

**FORD**

## PICKUP 1/2 TON, F-150 (cont)

96	4WD, Suspensión Quad adelante del Eje Delantero; Exc. Kit de Levantamiento		G63410 <sup>6</sup>	61546 <sup>6</sup>	58410 <sup>6</sup> 77410 <sup>6</sup>	....	42967		....	....	....	....	42966
	RWD		G63414	61520 <sup>6</sup> 81490	58414 <sup>6</sup> 77414 <sup>6</sup>	....	34057 <sup>8</sup> 42967		G63406	61547 81082	58406 77406	....	43167 <sup>8</sup> 49214 <sup>7</sup> 42966
91-95	Todos		....	....	....	....	42967		....	....	....	....	....
	3.8L MFI		....	....	....	....	42967		....	....	....	....	42966
	4WD, Con o sin Suspensión Quad detrás del Eje Delantero; Exc. Kit de Levantamiento		G63414 <sup>6</sup>	61520 <sup>6</sup> 81490	58414 <sup>6</sup> 77414 <sup>6</sup>	....	34057 <sup>8</sup> 42967		....	....	....	....	....
	4WD, Exc. Kit de Levantamiento		....	....	....	....	42967		G63461	61530 81510	58461 77461	....	49217 <sup>7</sup>
	4WD, Suspensión Quad adelante del Eje Delantero; Exc. Kit de Levantamiento		G63410 <sup>6</sup>	61546 <sup>6</sup>	58410 <sup>6</sup> 77410 <sup>6</sup>	....	42967		....	....	....	....	....
	RWD		G63414	61520 <sup>6</sup> 81490	58414 <sup>6</sup> 77414 <sup>6</sup>	....	34057 <sup>8</sup> 42967		G63406	61547 81082	58406 77406	....	43167 <sup>8</sup> 49214 <sup>7</sup>
87-90	5L FI		....	....	....	....	42967		....	....	....	....	42966
85-90	RWD		G63414	61520 <sup>6</sup> 81490	58414 <sup>6</sup> 77414 <sup>6</sup>	....	34057 <sup>8</sup>		G63406	61547 81082	58406 77406	....	43167 <sup>8</sup> 49214 <sup>7</sup>
80-90	4WD, Con o sin Suspensión Quad detrás del Eje Delantero; Exc. Kit de Levantamiento		G63414 <sup>6</sup>	61520 <sup>6</sup> 81490	58414 <sup>6</sup> 77414 <sup>6</sup>	....	34057 <sup>8</sup>		....	....	....	....	....
	4WD, Exc. Kit de Levantamiento		....	....	....	....	....		G63461	61530 81510	58461 77461	....	49217 <sup>7</sup>
	4WD, Suspensión Quad adelante del Eje Delantero; Exc. Kit de Levantamiento		G63410 <sup>6</sup>	61546 <sup>6</sup>	58410 <sup>6</sup> 77410 <sup>6</sup>	....	....		....	....	....	....	....
90	3.8L FI		....	....	....	....	42967		....	....	....	....	....
	3.8L MFI		....	....	....	....	....		....	....	....	....	42966
84-89	3.8L FI		....	....	....	....	42967		....	....	....	....	42966
84-86	3.8L MFI		....	....	....	....	....		....	....	....	....	42958
80-86	Kit de Levantamiento de 3-4"		G63445 <sup>50</sup>	....	....	....	....		G63439 <sup>50</sup>	....	....	....	....
	4WD, Suspensión Quad c/ Kit de Levantamiento de 3-4" adelante del Eje Delantero		G63446 <sup>6</sup>	....	....	....	....		....	....	....	....	....
86	5L FI		....	....	....	....	42967		....	....	....	....	42958 42966
80-84	RWD		G63414	61520 <sup>6</sup> 81490	58414 <sup>6</sup> 77414 <sup>6</sup>	....	34057 <sup>8</sup>		G63409	61554 81710	58409 77409 <sup>6</sup>	....	43142 <sup>8</sup> 49197 <sup>7</sup>
78-79	4WD, Detrás del Eje Delantero		G63396	....	....	....	....		....	....	....	....	....
	4WD, Extended Cab Pickup Exc. Kit de Levantamiento		G63398	....	....	....	....		....	....	....	....	....
	4WD; Suspensión Quad Amortiguador Largo; Exc. Ranger XLT Model y Kit de Levantamiento		G63511 <sup>6</sup>	61551 <sup>6</sup>	....	....	....	....		....	....	....	....
77-79	4WD, Cab & Chassis Kit de Levantamiento de 3-4" Exc. Suspensión Quad		G63445 <sup>50</sup>	....	....	....	....		G63447 <sup>50</sup>	....	....	....	....
	4WD, Standard Cab Pickup Kit de Levantamiento de 3-4" Exc. Suspensión Quad		G63445 <sup>50</sup>	....	....	....	....		G63447 <sup>50</sup>	....	....	....	....
	4WD; Exc. Kit de Levantamiento		....	....	....	....	....		G63387	61647 81285	58387	....	49178 <sup>7</sup>
75-79	RWD		G63386	61521 <sup>6</sup> 81394	58386	....	34058 <sup>8</sup>		G63350	61518 81242	58350	....	49173 <sup>7</sup>
	RWD, Standard Cab Pickup		....	....	....	....	....		....	....	....	....	43099 <sup>8</sup>
72-79	desde 2a. Serie 72		....	....	....	....	70169		....	....	....	....	....
79	4.7L DOHC, FI		....	....	....	....	42965		....	....	....	....	42959



6 Se recomienda que cuando se reemplacen amortiguadores "quad", los 4 sean de la misma serie.

8 Paquetes en pares

7 Paquetes en pares; kit de mangueras de aire incluido

50 Para proteger la barra del pistón, se recomienda utilizar el kit Bellows No.141242.

# AMORTIGUADORES Y STRUTS

Año	Notas de Aplicación										
		Ultra	ProGuard\ Guardian	Max Control\ LTV	Protector de Strut\ Bases de Strut	HiJacker\ Soporte\ Hidráulico	Ultra	ProGuard\ Guardian	Max Control\ LTV	Protector de Strut\ Bases de Strut	HiJacker\ Soporte\ Hidráulico

FORD

FORD

## PICKUP 1/2 TON, F-150 (cont)

77	4WD	○	G63396	....	....	....	....	....	....	....	....
75-76	4WD; Exc. Kit de Levantamiento	○	....	82033	....	....	....	....	....	....	49178 <sup>7</sup>
	4WD; Kit de Levantamiento; Exc. Extended Cab	○	....	....	....	....	....	....	....	....	....

## PICKUP 1/2 TON, F-150 ESTABILIZADORES DE DIRECCIÓN

		Delantero	Trasero
97-03	4WD	6861SE <sup>82</sup>	....
	RWD, Coil(FrontSpringType)	6860SE <sup>82</sup>	....
94-96	4WD, Estabilizador de Dirección Sistema Sencillo c/ Vigas Dobles de Tracción	6802SE <sup>84</sup>	....
90-93	Estabilizador de Dirección Sistema Sencillo	6802SE <sup>84</sup>	....
80-89	Todos	6802SE <sup>84</sup>	....
77-79	Estabilizador de Dirección Sistema Dual; Exc. Barra Estabilizadora	6802SE <sup>84</sup>	....
76-79	4WD	14016	....
	4WD, Estabilizador de Dirección Sistema Sencillo	6803SE <sup>84</sup>	....
75-76	RWD	6802SE <sup>84</sup>	....
75	4WD	14016	....

## PICKUP 3/4 TON, F-250 / SUPERDUTY

13	4WD	○	G63886	....	....	....	....	....	....	....	....
	RWD	○	G63622	....	....	....	....	....	....	....	....
05-12	4WD	○	G63886	61680	77951	....	....	....	....	....	....
	RWD	○	G63622	....	58807 77807	....	....	....	....	....	....
99-04	4WD	○	G63809	61655	58809 77809	....	....	....	....	....	....
	RWD	○	G63622	....	58807 77807	....	....	....	....	....	....
01	4.6L 8Cyl (281) 4WD; 2BBL	○	....	81821	....	....	....	....	....	....	....
97-99	4WD, Hasta PBV 8500#, Exc. Superduty	○	G63716	61613 81914	58716 77716	....	....	....	....	....	....
	RWD, Hasta PBV 8500#	○	G63714	61611 81912	58714 77714	....	....	....	....	....	49237 <sup>7</sup>
98	4WD, PBV arriba de 8500#	○	G63455	....	77455	....	....	....	....	....	....
97	4WD, PBV arriba de 8500#	○	G63455	61614 81821	58455 77455	....	....	....	....	....	49241 <sup>7</sup>
	RWD, PBV arriba de 8500#	○	G63414	61520 <sup>6</sup> 81490	58414 77414 <sup>6</sup>	....	....	....	....	....	43167 <sup>8</sup> 49214 <sup>7</sup>
87-96	4WD	○	G63455	61614 81821	58455 77455	....	....	....	....	....	49241 <sup>7</sup>
80-96	RWD	○	G63414	61520 <sup>6</sup> 81490	58414 <sup>6</sup> 77414 <sup>6</sup>	....	34057 <sup>8</sup>	....	....	....	43167 <sup>8</sup> 49214 <sup>7</sup>
96	RWD, Hasta PBV 8500#	○	....	61611	58714 77714	....	....	....	....	....	....
86	4WD	○	....	....	....	....	....	....	....	....	49217 <sup>7</sup>
	4WD, Montaje Inferior Delantero Tipo Abrazadera Exc. Doble Rodado o Kit de Levantamiento	○	G63416	....	58416	....	....	....	....	....	....
83-85	4WD, Montaje Inferior Delantero Tipo Abrazadera Exc. Doble Rodado o Kit de Levantamiento	○	G63416	....	58416	....	....	....	....	....	49217 <sup>7</sup>
80-82	4WD, Extended Cab Pickup	○	G63416	....	58416	....	....	....	....	....	....
	4WD, Standard Cab Pickup	○	G63410	....	58410	....	....	....	....	....	....
82	4WD	○	....	61546 <sup>6</sup>	77410 <sup>6</sup>	....	....	....	....	....	....

6 Se recomienda que cuando se reemplacen amortiguadores "quad", los 4 sean de la misma serie.

8 Paquetes en pares





82 Use kit si está señalado. Vea Ref. C para Botas.

7 Paquetes en pares; kit de mangueras de aire incluido

50 Para proteger la barra del pistón, se recomienda utilizar el kit Bellows No.141242.

84 Amortiguador de repuesto para los vehículos con el kit de montaje aftermarket GRC

# AMORTIGUADORES Y STRUTS

Año	Notas de Aplicación										
			Ultra	ProGuard\ Guardian	Max Control\ LTV	Protector de Strut\ Bases de Strut	HiJacker\ Soporte\ Hidráulico		Ultra	ProGuard\ Guardian	Max Control\ LTV

## FORD

## FORD

### PICKUP 3/4 TON, F-250 / SUPERDUTY (cont)

82	4WD, Montaje Inferior Delantero Tipo Abrazadera Exc. Doble Rodado o Kit de Levantamiento		....	....	....	....	....	....	....	....	G63461	61530 81510	58461 77461	....	49217 <sup>7</sup>
80-81	4WD	I O	....	61546 <sup>6</sup>	77410 <sup>6</sup>	....	....	....	....	....	G63461	61530 81510	58461 77461	....	49217 <sup>7</sup>
77-79	4WD, Cab & Chassis Aplica para toda la serie No. Y20001	I I	G63398	....	....	....	....	....	....	....	G63387	81285	58387	....	49178 <sup>7</sup>
	4WD, Standard Cab Pickup Aplica para toda la serie No. Y20001	I I	G63398	....	....	....	....	....	....	....	G63387	81285	58387	....	49178 <sup>7</sup>
75-79	RWD, Cab & Chassis	I O	....	....	....	....	....	....	....	....	G63350	61518 81242	58350	....	43058 <sup>8</sup> 49127 <sup>7</sup>
	RWD, Extended Cab Pickup	I O	....	....	....	....	....	....	....	....	G63377	61519 81484	58377	....	43058 <sup>8</sup> 49127 <sup>7</sup>
	RWD, Standard Cab Pickup	I O	....	....	....	....	....	....	....	....	G63350	61518 81242	58350	....	43099 <sup>8</sup> 49173 <sup>7</sup>
73-79	RWD	I O	G63386	61521 <sup>6</sup> 81394	58386	....	....	....	....	....	....	....	77377	....	....
72-79	desde 2a. Serie 72	I O	....	....	....	....	....	....	....	....	....	....	....	....	70169
70-77	4WD; Toda la serie No. Y20000	I I	G63187	82034	....	....	....	....	....	....	....	82147	....	....	....
73-74	RWD, Exc. Supercab	I O	....	....	....	....	....	....	....	....	G63350	61518 81242	58350	....	....
71-74	RWD, Exc. Extended Cab & Chassis Cab	I O	....	....	....	....	....	....	....	....	....	....	....	....	49173 <sup>7</sup>
	RWD, Standard Cab Pickup	I O	....	....	....	....	....	....	....	....	....	....	....	....	43099 <sup>8</sup>
70-74	RWD; Supercab	I O	....	....	....	....	....	....	....	....	G63377	61519 81484	58377	....	43058 <sup>8</sup>
70-72	RWD	I O	G63386	61521 <sup>6</sup> 81394	58386	....	....	....	....	....	....	....	58350 77377	....	....
	RWD, Exc. Supercab	I O	....	....	....	....	....	....	....	....	G63350	61518 81242	....	....	....
70	RWD, Standard Cab Pickup Exc. Supercab	I O	....	....	....	....	....	....	....	....	....	....	....	....	43099 <sup>8</sup>
66-69	4WD; Toda la serie No. Y20000	I I	G63187	82034	....	....	....	....	....	....	....	82147	....	....	43058 <sup>8</sup>
65-69	Todos	I O	....	....	....	....	....	....	....	....	....	....	....	....	43058 <sup>8</sup>
	RWD	I O	G63386	61521 <sup>6</sup> 81394	58386	....	....	....	....	....	....	61519	58377 77377	....	43058 <sup>8</sup>
	RWD; Supercab	I O	....	....	....	....	....	....	....	....	G63377	81484	....	....	49127 <sup>7</sup> 43058 <sup>8</sup>
65	4WD; Toda la serie No. Y20000	I I	G63187	82034	....	....	....	....	....	....	....	....	....	....	43058 <sup>8</sup>
61-64	Todos	I O	....	....	....	....	....	....	....	....	G63405	61500 81147	77405	....	43048 <sup>8</sup> 49310 <sup>7</sup>
	4WD; Toda la serie No. Y20000	I I	G63187	82034	....	....	....	....	....	....	G63405	61500 81147	77405	....	43048 <sup>8</sup> 49310 <sup>7</sup>
61-62	RWD	I I	....	82038	....	....	....	....	....	....	G63405	61500 81147	77405	....	43048 <sup>8</sup> 49310 <sup>7</sup>
60	Todos	I I	....	81270	....	....	....	....	....	....	....	82123	....	....	....
53-55	Exc. Heavy Duty	I O	....	....	....	....	....	....	....	....	....	81676	....	....	....

### PICKUP 3/4 TON, F-250 / SUPERDUTY ESTABILIZADORES DE DIRECCIÓN

		Delantero	Trasero
08-10	4WD	14072	....
05-07	4WD, Exc. Estabilizador de Dirección de EO	6856SE <sup>82</sup>	....
05-06	Exc. Estabilizador de Dirección de EO	6856SE <sup>82</sup>	....
99-04	4WD, Exc. Unidad de EO	6850SE <sup>82</sup>	....
99-04	4WD, Kit de Reemplazo	6855SE <sup>82</sup>	....
99-03	4WD, Con Amortiguador de EO	6854SE <sup>80</sup>	....
	RWD	6828SE <sup>80</sup>	....
97-99	4WD, Barra de Torsion(FrontSpringType)	6861SE <sup>82</sup>	....

6 Se recomienda que cuando se reemplacen amortiguadores "quad", los 4 sean de la misma serie.



8 Paquetes en pares

82 Use kit si está señalado. Veá Ref. C para Botas.

7 Paquetes en pares; kit de mangueras de aire incluido

80 No requiere soportes para el montaje, instalar sobre montajes de EO Veá Ref. C para Botas.

# AMORTIGUADORES Y STRUTS

Año	Notas de Aplicación										
		Ultra	ProGuard\ Guardian	Max Control\ LTV	Protector de Strut\ Bases de Strut	HiJacker\ Soporte\ Hidráulico	Ultra	ProGuard\ Guardian	Max Control\ LTV	Protector de Strut\ Bases de Strut	HiJacker\ Soporte\ Hidráulico

FORD

FORD

## PICKUP 3/4 TON, F-250 / SUPERDUTY ESTABILIZADORES DE DIRECCIÓN (cont)

		Delantero	Trasero
97-99	RWD, Coil(FrontSpringType)	6860SE <sup>82</sup>	....
97-98	4WD, PBV arriba de 8600# y HD	6862SE <sup>82</sup>	....
92-97	RWD, Reemplazo de Estabilizador de EO Sistema Sencillo	6807SE <sup>80</sup>	....
80-96	4WD, Estabilizador de Dirección Sistema Sencillo	6802SE <sup>84</sup>	....
77-79	4WD, Power Steering Estabilizador de Dirección Sistema Sencillo	6805SE <sup>80</sup>	....
73-79	RWD, Estabilizador de Dirección Sistema Sencillo	6802SE <sup>84</sup>	....
75-77	4WD, Manual Steering Estabilizador de Dirección Sistema Sencillo	6803SE <sup>84</sup>	....
73-74	4WD, Estabilizador de Dirección Sistema Sencillo	6803SE <sup>84</sup>	....
60-72	Estabilizador de Dirección Sistema Sencillo	6803SE <sup>84</sup>	....

## PICKUP 1 TON, F-350 / SUPERDUTY

05-12	4WD	⊕	G63886	61680	77951	....	....	....	....	....
	4WD; Rodado Sencillo; Exc. Cab & Chassis	⊖	....	....	....	....	....	....	....	....
05-07	RWD	⊕	G63622	....	58807 77807	....	....	....	....	....
	4WD; Doble Rodada Trasera; Exc. Cab & Chassis	⊖	....	....	....	....	....	....	....	....
05-06	4WD, Cab & Chassis	⊖	....	....	....	....	....	....	....	....
01-04	RWD	⊕	G63622	....	58807 77807	....	....	....	....	....
	4WD	⊖	G63809	61655	58809 77809	....	....	....	....	....
96-04	Super Duty 4x2	⊖	....	61653	....	....	....	....	....	....
99-00	5.4L 8Cyl (330) MFI	⊖	....	....	....	....	....	....	....	....
	5.4L 8Cyl (330) RWD; MFI	⊕	G63414	61520	....	....	....	....	....	....
	RWD	⊕	G63622	81490	58807 77807	....	....	....	....	....
94-97	4WD 5L 8Cyl (302) FI	⊖	G63455	....	....	....	....	....	....	....
86-97	4WD	⊖	G63455	61614 81821	58455 77455	....	....	....	....	....
	4WD	⊖	....	....	....	....	42952	....	....	....
	4WD, Doble Rodada Trasera	⊖	....	....	....	....	....	....	....	....
	4WD, Exc. Doble Rodada Trasera	⊖	....	....	....	....	....	....	....	....
80-97	Eje Trasero Doble Rodado	⊕	....	....	....	....	70169	....	....	....
	RWD	⊕	G63414	61520 <sup>6</sup> 81490	58414 <sup>6</sup> 77414 <sup>6</sup>	....	....	....	....	....
	RWD	⊕	....	....	....	....	....	....	....	....
	RWD, Doble Rodada Trasera	⊖	....	....	....	....	....	....	....	....
	RWD, Exc. Doble Rodada Trasera	⊖	....	....	....	....	....	....	....	43167 <sup>6</sup>
86-92	4WD 5L 8Cyl (302) FI	⊖	G63455	....	....	....	....	....	....	....
86-90	4WD 5.8L 8Cyl (351) SOHC; TBI	⊖	G63455	....	....	....	....	....	....	....
83-85	5L 8Cyl (302) FI	⊕	G63410	61546	....	....	....	....	....	....
82-85	4WD, Montaje Inferior Delantero Tipo Abrazadera Exc. Doble Rodado o Kit de Levantamiento	⊕	G63416	....	58416	....	....	....	....	49217 <sup>7</sup>
80-85	5L FI	⊖	....	....	....	....	42952	....	....	....
80-81	4WD	⊕	G63410	61546 <sup>6</sup>	58410 77410 <sup>6</sup>	....	....	....	77461	....

6 Se recomienda que cuando se reemplacen amortiguadores "quad", los 4 sean de la misma serie.

8 Paquetes en pares

82 Use kit si está señalado. Vea Ref. C para Botas.





7 Paquetes en pares; kit de mangueras de aire incluido

80 No requiere soportes para el montaje, instalar sobre montajes de EO Vea Ref. C para Botas.

84 Amortiguador de repuesto para los vehículos con el kit de montaje aftermarket GRC

































# AMORTIGUADORES Y STRUTS

Año	Notas de Aplicación										
			Ultra	ProGuard\ Guardian	Max Control\ LTV	Protector de Strut\ Bases de Strut	HiJacker\ Soporte\ Hidráulico		Ultra	ProGuard\ Guardian	Max Control\ LTV

**FORD**

**FORD**

## PICKUP 1 TON, F-350 / SUPERDUTY (cont)



80-81	4WD, Doble Rodada Trasera		....	....	....	....		G63461	61530 81510	58461	....	....
80	5L 8Cyl (302) FI		....	61546	....	....		....	....	....	....	....
75-79	RWD		....	61521 <sup>6</sup> 81394	58386	....		....	....	....	....	70172
	RWD, Cab & Chassis		....	....	....	....		....	....	....	....	43099 <sup>8</sup> 49173 <sup>7</sup> 70172
	RWD, Extended Cab Pickup		G63396	....	....	....		....	....	58350	....	43099 <sup>8</sup> 49173 <sup>7</sup> 70172
	RWD, Standard Cab Pickup		G63386	....	....	....		G63377	61519 81484	58377 77377	....	43058 <sup>8</sup> 49127 <sup>7</sup> 70172
	RWD; Supercab		....	....	....	....		G63350	61518 81242	....	....	70172
67-79	Todos		....	....	....	....		....	....	....	....	70172
	RWD		....	....	....	....		....	....	....	....	70172
79	4WD		G63398	....	....	....		G63387	61647 81285	58387	....	49178 <sup>7</sup> 70172
	5L FI		....	....	....	....		....	....	....	....	70172
67-78	5L FI		....	....	....	....		....	....	....	....	42964 70172
78	4WD 5L 8Cyl (302) FI		G63455	....	....	....		G63377	....	....	....	70172
	5L 8Cyl (302) FI		....	61614 81821	....	....		....	61519 81484	....	....	70172
74-77	4.7L 8Cyl (289) DOHC; MFI		....	61614 81821	....	....		....	61519 81484	....	....	70172
	4WD 4.7L 8Cyl (289) DOHC; MFI		G63455	....	....	....		G63377	....	....	....	70172
67-77	4.7L DOHC, MFI		....	....	....	....		....	....	....	....	42964 70172
77	4WD 5L 8Cyl (302) FI		G63455	....	....	....		....	....	....	....	70172
	5L 8Cyl (302) FI		....	61614 81821	....	....		....	....	....	....	70172
76	4WD 5L 8Cyl (302) FI		G63455	....	....	....		G63377	....	....	....	70172
	5L 8Cyl (302) FI		....	61614 81821	....	....		....	61519 81484	....	....	70172
73-74	Todos		....	81394	....	....		....	....	....	....	70172
	RWD		....	61521	....	....		....	....	....	....	70172
74	4WD 5L 8Cyl (302) FI		G63455	....	....	....		G63377	....	....	....	70172
	5L 8Cyl (302) FI		....	61614 81821	....	....		....	61519 81484	....	....	70172
	RWD, Extended Cab & Chassis Cab		....	....	....	....		....	....	....	....	49173 <sup>7</sup> 70172
	RWD; Exc. Supercab		G63386	....	58386	....		G63377	61519 81484	58350 77377	....	43099 70172
	RWD; Supercab		....	....	....	....		G63350	61518 81242	....	....	43058 <sup>8</sup> 70172
	Standard Cab Pickup		....	....	....	....		....	....	....	....	49127 <sup>7</sup> 70172
71-73	4.7L 8Cyl (289) DOHC; MFI		....	61614 81821	....	....		G63377	61519 81484	....	....	70172
67-73	4WD 4.7L 8Cyl (289) DOHC; MFI		G63455	....	....	....		....	....	....	....	70172
	4WD 5L 8Cyl (302) FI		G63455	....	....	....		....	....	....	....	70172
	5L 8Cyl (302) FI		....	61614 81821	....	....		G63377	61519 81484	....	....	70172
73	RWD, Standard Cab Pickup		....	....	....	....		....	....	....	....	49127 <sup>7</sup> 70172

6 Se recomienda que cuando se reemplacen amortiguadores "quad", los 4 sean de la misma serie.

8 Paquetes en pares

7 Paquetes en pares; kit de mangueras de aire incluido

# AMORTIGUADORES Y STRUTS

Año	Notas de Aplicación										
		Ultra	ProGuard\ Guardian	Max Control\ LTV	Protector de Strut\ Bases de Strut	HiJacker\ Soporte\ Hidráulico	Ultra	ProGuard\ Guardian	Max Control\ LTV	Protector de Strut\ Bases de Strut	HiJacker\ Soporte\ Hidráulico

FORD

FORD

## PICKUP 1 TON, F-350 / SUPERDUTY (cont)

73	RWD; Exc. Supercab	○	G63386	....	58386	....	34058 <sup>8</sup> 70169	○	G63377	61519 81484	77377	....	70172	
	RWD; Supercab	○	....	....	....	....	70169	○	....	....	....	....	43058 <sup>8</sup> 70172	
67-72	RWD	○	....	61521 81394	....	....	70169	○	....	....	....	....	70172	
	RWD, Exc. Supercab	○	G63386	....	....	....	70169	○	....	....	....	....	70172	
67-70	4.7L 8Cyl (289) DOHC; FI	○	....	....	....	....	70169	○	G63377	61519 81484	....	....	70172	
	4.7L DOHC, FI	○	....	....	....	....	70169	○	....	....	....	....	42964 70172	
70	4.7L 8Cyl (289) DOHC; MFI	○	....	61614 81821	....	....	70169	○	....	81484	....	....	70172	
67-69	4.7L 8Cyl (289) DOHC; MFI	○	....	61614 81821	....	....	70169	○	....	....	....	....	70172	
67	4WD 5.8L 8Cyl (352) SOHC; TBI	○	G63455	....	....	....	70169	○	....	....	....	....	70172	
	5.8L 8Cyl (352) SOHC; MFI	○	....	....	....	....	70169	○	G63377	61519 81484	....	....	70172	
	5.8L 8Cyl (352) SOHC; TBI	○	....	61614 81821	....	....	70169	○	....	....	....	....	70172	
	5.8L SOHC, MFI	○	....	....	....	....	70169	○	....	....	....	....	42964 70172	
	5.8L SOHC, TBI	○	....	....	....	....	42952 70169	○	....	....	....	....	42964 70172	
65-66	4.7L 8Cyl (289) DOHC; FI	○	....	....	....	....	....	○	G63405	61500	77405	....	43048 <sup>8</sup> 49310 <sup>7</sup>	
	4.7L 8Cyl (289) DOHC; MFI	○	....	61614 81821	....	....	....	○	G63405	81510 61500	77405	....	43048 <sup>8</sup> 49310 <sup>7</sup>	
	4.7L DOHC, MFI	○	....	....	....	....	42952	○	G63405	61500	77405	....	43048 <sup>8</sup> 49310 <sup>7</sup>	
	4WD 4.7L 8Cyl (289) DOHC; MFI	○	G63455	....	....	....	....	○	G63405	61500	77405	....	43048 <sup>8</sup> 49310 <sup>7</sup>	
	4WD 5.8L 8Cyl (352) TBI	○	G63455	....	....	....	....	○	G63405	61500	77405	....	43048 <sup>8</sup> 49310 <sup>7</sup>	
	4WD 5L 8Cyl (302) FI	○	G63455	....	....	....	....	○	G63405	61500	77405	....	43048 <sup>8</sup> 49310 <sup>7</sup>	
	5.8L TBI	○	....	....	....	....	42952	○	G63405	61500	77405	....	43048 <sup>8</sup> 49310 <sup>7</sup>	
	5L 8Cyl (302) FI	○	....	61614 81821	....	....	....	....	○	G63405	81510 61500	77405	....	43048 <sup>8</sup> 49310 <sup>7</sup>
	5L FI	○	....	....	....	....	42952	....	○	G63405	61500	77405	....	43048 <sup>8</sup> 49310 <sup>7</sup>
61-66	Todos	○	....	....	....	....	....	○	G63405	61500	77405	....	43048 <sup>8</sup> 49310 <sup>7</sup>	
	Hasta PBV 8000#	○	....	....	....	....	....	○	G63405	81147 61500	77405	....	43048 <sup>8</sup> 49310 <sup>7</sup>	
66	5.8L 8Cyl (352) SOHC; MFI	○	....	....	....	....	....	○	G63405	61500	77405	....	43048 <sup>8</sup> 49310 <sup>7</sup>	
	5.8L 8Cyl (352) TBI	○	....	61614 81821	....	....	....	○	G63405	81510 61500	77405	....	43048 <sup>8</sup> 49310 <sup>7</sup>	
65	5.8L 8Cyl (352) SOHC; FI	○	....	....	....	....	....	○	G63405	61500	77405	....	43048 <sup>8</sup> 49310 <sup>7</sup>	
	5.8L 8Cyl (352) SOHC; VTEC	○	....	61614	....	....	....	○	G63405	61500	77405	....	43048 <sup>8</sup> 49310 <sup>7</sup>	
	5.8L 8Cyl (352) TBI	○	....	81821	....	....	....	○	G63405	81510 61500	77405	....	43048 <sup>8</sup> 49310 <sup>7</sup>	
60	Todos	○	....	81270	....	....	....	○	....	....	....	....	....	
53-55	Exc. Heavy Duty	○	....	....	....	....	....	○	....	81676	....	....	....	

### PICKUP 1 TON, F-350 / SUPERDUTY ESTABILIZADORES DE DIRECCIÓN





		Delantero	Trasero
08-10	4WD	14072	....
99-06	RWD	6828SE <sup>80</sup>	....

7 Paquetes en pares; kit de mangueras de aire incluido

8 Paquetes en pares

80 No requiere soportes para el montaje, instalar sobre montajes de EO Veá Ref. C para Botas.

# AMORTIGUADORES Y STRUTS





Año	Notas de Aplicación										
			Ultra	ProGuard\ Guardian	Max Control\ LTV	Protector de Strut\ Bases de Strut	HiJacker\ Soporte\ Hidráulico		Ultra	ProGuard\ Guardian	Max Control\ LTV

**FORD**

**FORD**

PICKUP 1 TON, F-350 / SUPERDUTY ESTABILIZADORES DE DIRECCIÓN (cont)		Delantero	Trasero
99-04	4WD, Exc. Unidad de EO	6850SE <sup>82</sup>	....
	4WD, Kit de Reemplazo	6855SE <sup>82</sup>	....
99-03	4WD, Con Amortiguador de EO	6854SE <sup>80</sup>	....
95-97	4WD	6826SE <sup>80</sup>	....
92-97	RWD, Reemplazo de Estabilizador de EO Sistema Sencillo	6807SE <sup>80</sup>	....
92-96	RWD, Estabilizador de Dirección Sistema Dual	6802SE <sup>84</sup>	....
89-91	RWD, Estabilizador de Dirección Sistema Sencillo	6802SE <sup>84</sup>	....
82-88	Estabilizador de Dirección Sistema Sencillo, c/ Barra Estabilizadora	6802SE <sup>84</sup>	....
79-81	RWD, Estabilizador de Dirección Sistema Dual	6802SE <sup>84</sup>	....
79	4WD, Power Steering Estabilizador de Dirección Sistema Sencillo	6805SE <sup>80</sup>	....
75-78	Estabilizador de Dirección Sistema Dual	6802SE <sup>84</sup>	....
75-77	Manual Steering Estabilizador de Dirección Sistema Sencillo	6803SE <sup>84</sup>	....
65-74	Estabilizador de Dirección Sistema Sencillo c/ Eje de Doble Viga en I	6802SE <sup>84</sup>	....
63-74	Estabilizador de Dirección Sistema Sencillo	6803SE <sup>84</sup>	....
60-64	Estabilizador de Dirección Sistema Sencillo c/ Eje de Viga en I	6802SE <sup>84</sup>	....
62	Estabilizador de Dirección Sistema Sencillo Manual Steering	6803SE <sup>84</sup>	....
60-61	Estabilizador de Dirección Sistema Sencillo	6803SE <sup>84</sup>	....



## PICKUP P350

76	Todos		....	61500	....	....	....	....	....	....
	Hasta PBV 8000#		G63405	61500	77405	....	....	....	....	....
68-75	Todos		....	....	....	....	....	....	....	....
	Hasta PBV 8000#		G63405	61500 81147	77405	....	....	....	....	....











## PICKUP P350 ESTABILIZADORES DE DIRECCIÓN

PICKUP P350 ESTABILIZADORES DE DIRECCIÓN		Delantero	Trasero
68-73	Estabilizador de Dirección Sistema Sencillo	6802SE <sup>84</sup>	....

## PICKUP P400

75-76	Todos		....	....	....	....	....	....	....	....
	Hasta PBV 8000#		G63405	61500 81147	77405	....	....	....	....	....

## PICKUP, F-450 SUPERDUTY

09-12	Cab & Chassis		....	....	....	....	....	....	....	....
07-08	Todos		G63969	....	77967	....	....	....	....	....
	Cab & Chassis		G63969	....	77967	....	....	....	....	....
07	4WD		G63969	....	77967	....	....	....	....	....
	RWD		G63969	....	77967	....	....	....	....	....
05-06	Todos		G63969	....	77967	....	....	....	....	....
	4WD		G63969	....	77967	....	....	....	....	....
	RWD		G63969	....	77967	....	....	....	....	....
99-04	Todos		G63809	61655	58809 77809	....	....	....	....	....
97	Todos		G63692	....	....	....	....	....	....	....

## PICKUP, F-450 SUPERDUTY ESTABILIZADORES DE DIRECCIÓN

PICKUP, F-450 SUPERDUTY ESTABILIZADORES DE DIRECCIÓN		Delantero	Trasero
08-10	4WD	14072	....
99-04	4WD, Con Amortiguador de EO	6854SE <sup>80</sup>	....



6 Se recomienda que cuando se reemplacen amortiguadores "quad", los 4 sean de la misma serie.

82 Use kit si está señalado. Vea Ref. C para Botas.

80 No requiere soportes para el montaje, instalar sobre montajes de EO Vea Ref. C para Botas.

84 Amortiguador de repuesto para los vehículos con el kit de montaje aftermarket GRC

# AMORTIGUADORES Y STRUTS

Año	Notas de Aplicación										
		Ultra	ProGuard\ Guardian	Max Control\ LTV	Protector de Strut\ Bases de Strut	HiJacker\ Soporte\ Hidráulico	Ultra	ProGuard\ Guardian	Max Control\ LTV	Protector de Strut\ Bases de Strut	HiJacker\ Soporte\ Hidráulico

## FORD

## FORD

### PICKUP, F-550 SUPERDUTY

08-12	Todos		....	....	....	....	....	....	58942	....	....
07	Todos	⊕	G63969	....	77967	....	....	....	58942	....	....
	4WD	⊕	G63969	....	77967	....	....	....	77969 58942	....	....
	RWD	⊕	G63969	....	77967	....	....	....	77968 58942	....	....
05-06	Todos	⊕	G63969	....	77967	....	....	....	G63963	....	....
	4WD	⊕	G63969	....	77967	....	....	....	G63963	61694	77969
	RWD	⊕	G63969	....	77967	....	....	....	G63963	61693	77968
99-04	Todos	⊕	G63809	61655	58809 77809	....	....	....	G63811	61657	58811 77461

### PICKUP, F-550 SUPERDUTY ESTABILIZADORES DE DIRECCIÓN

		Delantero	Trasero
08-10	4WD	14072	....
99-04	4WD, Con Amortiguador de EO	6854SE <sup>80</sup>	....

## RANGER

12-14	Todos		....	....	....	....	....	....	<b>G64131<sup>4</sup></b>	....	....	....	....
07-11	RWD, Coil(FrontSpringType)	⊕	G63772	61626 81916	77772	....	....	....	G63773	61627 81917	77525	....	43167 <sup>8</sup>
06-11	4WD	⊕	G63678	61623 81893	77678	....	....	....	G63775	61629 81918	77524	....	43184 43185
	RWD, Barra de Torsión(FrontSpringType)	⊕	G63678	61623 81893	77678	....	....	....	G63775	61629 81918	77524	....	....
06	RWD, Coil(FrontSpringType)	⊕	G63772	61626 81916	77772	....	....	....	G63773	61627 81917	77525	....	43167 <sup>8</sup> 49223 <sup>7</sup>
01-05	4WD		....	....	....	....	....	....	....	....	....	....	43184 43185
	Edge, 4WD, RWD	⊕	G63678	61623 81893	77678	....	....	....	G63775	61629 81918	77524	....	....
98-05	Exc. Modelos Edge, EV, Splash & Deportivo	⊕	G63772	61626 81916	77772	....	....	....	G63773	61627 81917	77525	....	....
	RWD		....	....	....	....	....	....	....	....	....	....	43167 <sup>8</sup> 49223 <sup>7</sup>
98-00	4WD	⊕	G63678	61623 81893	77678	....	....	....	G63775	61629 81918	77524	....	43184 43185
90-97	Todos	⊕	G63614	61561 81744	58929 77614	....	....	....	....	....	....	....	....
	4WD	⊕	G63614	61561 81744	58929 77614	....	....	....	G63524	61573 81905	77524	....	43184 43185
	RWD	⊕	G63614	61561 81744	58929 77614	....	....	....	G63525	61559 81730	77525	....	43167 <sup>8</sup> 49223 <sup>7</sup>
87-89	Exc. Opción High Ryder	⊕	G63414	61520 <sup>6</sup> 81490	77414 <sup>5</sup>	....	34057 <sup>8</sup>	....	....	....	....	....	....
89	4WD		....	....	....	....	....	....	G63524	61534 81540	....	....	43184 43185
	4WD, Fab. desde 2/89; Vehículos con perno de 12mm en montaje inferior trasero		....	....	....	....	....	....	....	81905	77524	....	....
	4WD, Opción High Ryder	⊕	G63603	....	....	....	....	....	....	61573	....	....	....
	RWD, Fab. desde 2/89; Vehículos con perno de 12mm en montaje inferior trasero		....	....	....	....	....	....	G63525	61559 81730	77525	....	49223 <sup>7</sup>
	RWD, Fab. hasta 2/89; Vehículos con perno 10mm & 12mm en montaje inferior trasero		....	....	....	....	....	....	G63427	61533 81539	....	....	43165 <sup>8</sup> 49207 <sup>7</sup>
87-88	4WD		....	....	....	....	....	....	G63420	61534 81540	....	....	43184 43185

4 Número de futuro, las cantidades disponibles Q4 2015

7 Paquetes en pares; kit de mangueras de aire incluido





80 No requiere soportes para el montaje, instalar sobre montajes de EO Vea Ref. C para Botas.

Texto en Negritas - Número de Parte Nuevo / Futuro

6 Se recomienda que cuando se reemplacen amortiguadores "quad", los 4 sean de la misma serie.

8 Paquetes en pares





# AMORTIGUADORES Y STRUTS

Año	Notas de Aplicación										
			Ultra	ProGuard\ Guardian	Max Control\ LTV	Protector de Strut\ Bases de Strut	HiJacker\ Soporte\ Hidráulico		Ultra	ProGuard\ Guardian	Max Control\ LTV

## FORD

## FORD

### RANGER (cont)

87-88	4WD, Opción High Ryder		G63603	....	....	....	....	....	....	....	....	....
	RWD		....	....	....	....	....	....	....	....	....	....
83-86	Todos		G63414	61520 <sup>6</sup> 81490	77414 <sup>6</sup>	....	....	....	....	....	....	43165 <sup>8</sup> 49207 <sup>7</sup>
	4WD		G63414	61520 <sup>6</sup> 81490	77414 <sup>6</sup>	....	....	....	....	....	....	43184 43185
	RWD		G63414	61520 <sup>6</sup> 81490	77414 <sup>6</sup>	....	....	....	....	....	....	43165 <sup>8</sup> 49207 <sup>7</sup>









### RANGER ESTABILIZADORES DE DIRECCIÓN

		Delantero	Trasero
83-97	Estabilizador de Dirección Sistema Sencillo	6802SE <sup>84</sup>	....

### TRANSIT

07-12	Todos		G52220	....	....	....	....	....	....	....	....
-------	-------	---	--------	------	------	------	------	------	------	------	------









### VAN 1/2 TON, ECONOLINE / CLUB WAGON

08-11	Todos		G63622	61591 81744	58929 77608	....	....	....	....	....	....	49178 <sup>7</sup>
92-07	Todos		G63929	61591 81744	58929 77608	....	....	....	....	....	....	49178 <sup>7</sup>
75-91	Todos		....	....	....	....	....	....	....	....	....	70168
	Todos		G63500	61553 81694	58500	....	....	....	....	....	....	43099 <sup>6</sup> 49173 <sup>7</sup> 70170
69-74	Todos		....	82012	....	....	....	....	....	....	....	43058 <sup>6</sup> 49127 <sup>7</sup>
68	A finales de 1968		....	82012	....	....	....	....	....	....	....	43058 <sup>6</sup> 49127 <sup>7</sup>
	Fabricado antes de Jul/68		G63492	61506 81318	77492	....	....	....	....	....	....	....
	A finales de 1968		....	....	....	....	....	....	....	....	....	....

### VAN 1/2 TON, ECONOLINE / CLUB WAGON ESTABILIZADORES DE DIRECCIÓN

		Delantero	Trasero
95-01	Kit de Repuesto	6858SE	....
69-74	Estabilizador de Dirección Sistema Sencillo c/ Eje de Doble Viga en I	6802SE <sup>84</sup>	....
68	Estabilizador de Dirección Sistema Sencillo c/ Eje de Viga en I	6802SE <sup>84</sup>	....

### VAN 3/4 TON, ECONOLINE / CLUB WAGON / SUPERDUTY

06-11	Todos		G63622	81744	58622 77614	....	....	....	....	....	....	49178 <sup>7</sup>
04-05	Todos		G63622	61591 81744	58622 77614	....	....	....	....	....	....	49178 <sup>7</sup>
03	Todos		G63622	81744	58622 77614	....	....	....	....	....	....	49178 <sup>7</sup>
92-02	Todos		G63622	61591 81744	58622 77614	....	....	....	....	....	....	49178 <sup>7</sup>
85-91	Todos		....	....	....	....	....	....	....	....	....	....
	Todos		G63386	61521 <sup>6</sup> 81394	58386	....	....	....	....	....	....	49178 <sup>7</sup>
75-84	Todos		G63386	61521 <sup>6</sup> 81394	58386	....	....	....	....	....	....	49178 <sup>7</sup>
69-74	Todos		....	82012	....	....	....	....	....	....	....	43058 <sup>6</sup> 49127 <sup>7</sup>
68	A finales de 1968		....	82012	....	....	....	....	....	....	....	43058 <sup>6</sup> 49127 <sup>7</sup>



6 Se recomienda que cuando se reemplacen amortiguadores "quad", los 4 sean de la misma serie.

8 Paquetes en pares

7 Paquetes en pares; kit de mangueras de aire incluido

84 Amortiguador de repuesto para los vehículos con el kit de montaje aftermarket GRC

# AMORTIGUADORES Y STRUTS

Año	Notas de Aplicación										
		Ultra	ProGuard\ Guardian	Max Control\ LTV	Protector de Strut\ Bases de Strut	HiJacker\ Soporte\ Hidráulico	Ultra	ProGuard\ Guardian	Max Control\ LTV	Protector de Strut\ Bases de Strut	HiJacker\ Soporte\ Hidráulico

**FORD**

**FORD**

## VAN 3/4 TON, ECONOLINE / CLUB WAGON / SUPERDUTY ESTABILIZADORES DE DIRECCIÓN

		Delantero	Trasero
95-01	Kit de Repuesto	6858SE	....
74-79	QuadraVan Special	6803SE <sup>84</sup>	....
69-74	Estabilizador de Dirección Sistema Sencillo c/ Eje de Doble Viga en I	6802SE <sup>84</sup>	....
68	Estabilizador de Dirección Sistema Sencillo c/ Eje de Viga en I	6802SE <sup>84</sup>	....

## VAN 1 TON, ECONOLINE / CLUB WAGON / SUPERDUTY

08-11	Exc. Paquete de Ambulancia & Manejo	⌋ ○ G63622	61591 81744	58622 77614	....	....	⌋ ○ G63623	61646 81828	58623 77623	....	49178 <sup>7</sup>
11	Todos	⌋ ○ G63622	61591 81744	....	....	....	⌋ ○ .....	....	....	....	49178 <sup>7</sup>
09-10	Todos	⌋ ○ G63622	61591 81744	77614	....	....	⌋ ○ .....	....	....	....	49178 <sup>7</sup>
08	Todos	⌋ ○ G63622	61591 81744	77614	....	....	⌋ ○ .....	....	77623	....	49178 <sup>7</sup>
	Conversión a Motorhome	⌋ ○ G63622	61591 81744	58622 77614	....	....	⌋ ○ .....	....	58623 77623	....	49178 <sup>7</sup>
07	Todos	⌋ ○ G63622	61591	77614	....	....	⌋ ○ .....	....	77623	....	49178 <sup>7</sup>
	Conversión a Motorhome	⌋ ○ G63622	61591	58622 77614	....	....	⌋ ○ .....	....	58623 77623	....	49178 <sup>7</sup>
	Exc. Paquete de Ambulancia & Manejo	⌋ ○ G63622	81744 61591	58622 77614	....	....	⌋ ○ G63623	61646 81828	58623 77623	....	49178 <sup>7</sup>
04-06	Exc. Paquete de Ambulancia & Manejo	⌋ ○ G63622	61591 81744	58622 77614	....	....	⌋ ○ G63623	61646 81828	58623 77623	....	49178 <sup>7</sup>
06	Todos	⌋ ○ G63622	61591 81744	77614	....	....	⌋ ○ .....	....	....	....	49178 <sup>7</sup>
04-05	Todos	⌋ ○ G63622	61591 81744	77614	....	....	⌋ ○ .....	61646 81828	....	....	49178 <sup>7</sup>
92-05	Conversión a Motorhome	⌋ ○ G63622	61591 81744	58622 77614	....	....	⌋ ○ G63623	61646 81828	58623 77623	....	49178 <sup>7</sup>
03	Todos	⌋ ○ .....	61591 81744	77614	....	....	⌋ ○ .....	61646 81828	....	....	49178 <sup>7</sup>
	Exc. Paquete de Ambulancia & Manejo	⌋ ○ .....	61591 81744	77614	....	....	⌋ ○ .....	61646 81828	77623	....	49178 <sup>7</sup>
92-02	Todos	⌋ ○ .....	61591 81744	....	....	....	⌋ ○ .....	61646 81828	....	....	49178 <sup>7</sup>
85-91	Todos	⌋ ○ .....	....	....	....	70169	⌋ ○ .....	....	....	....	....
	Todos	⌋ ○ .....	....	58386	....	34058 <sup>8</sup> 70169	⌋ ○ .....	....	58387	....	49178 <sup>7</sup>
	Conversión a Motorhome	⌋ ○ G63386	....	....	....	70169	⌋ ○ G63387	....	....	....	....
	Exc. Conversión Motorhome	⌋ ○ .....	61521 <sup>6</sup> 81394	58386	....	34058 <sup>8</sup> 70169	⌋ ○ .....	61647 81285	58387	....	49178 <sup>7</sup>
77-84	Todos	⌋ ○ .....	....	58386	....	34058 <sup>8</sup>	⌋ ○ .....	....	58387	....	49178 <sup>7</sup>
	Conversión a Motorhome	⌋ ○ G63386	....	58386	....	34058 <sup>8</sup>	⌋ ○ G63387	....	58387	....	49178 <sup>7</sup>
75-84	Exc. Conversión Motorhome	⌋ ○ .....	61521 <sup>6</sup> 81394	58386	....	34058 <sup>8</sup>	⌋ ○ .....	61647 81285	58387	....	49178 <sup>7</sup>
75-76	Conversión a Motorhome	⌋ ○ G63386	....	....	....	....	⌋ ○ G63387	....	....	....	....
69-74	Todos	⌋ ○ .....	82012	....	....	....	⌋ ○ G63377	61519 81484	77377	....	43058 <sup>8</sup> 49127 <sup>7</sup>
68	A finales de 1968	⌋ ○ .....	82012	....	....	....	⌋ ○ G63377	61519 81484	77377	....	43058 <sup>8</sup> 49127 <sup>7</sup>

## VAN 1 TON, ECONOLINE / CLUB WAGON / SUPERDUTY ESTABILIZADORES DE DIRECCIÓN

		Delantero	Trasero
95-02	Kit de Repuesto	6858SE	....

**GMC**

**GMC**

## CANYON





09-11	Barra de Torsion(FrontSpringType)	⌋ ○ .....	....	....	....	....	⌋ ○ G63879	....	....	....	....
-------	-----------------------------------	--------------	------	------	------	------	---------------	------	------	------	------

6 Se recomienda que cuando se reemplacen amortiguadores "quad", los 4 sean de la misma serie.

8 Paquetes en pares

7 Paquetes en pares; kit de mangueras de aire incluido  
84 Amortiguador de repuesto para los vehículos con el kit de montaje aftermarket GRC





# AMORTIGUADORES Y STRUTS

Año	Notas de Aplicación										
			Ultra	ProGuard\ Guardian	Max Control\ LTV	Protector de Strut\ Bases de Strut	HiJacker\ Soporte\ Hidráulico		Ultra	ProGuard\ Guardian	Max Control\ LTV







**GMC**

**GMC**



## CANYON (cont)

04-11	RWD, Coil(FrontSpringType) Exc. Paquete Z71 Off Road		G51850	....	....	....	....		G63882	....	....	....	....
04-08	Barra de Torsion(FrontSpringType)		G63884	....	....	....	....		G63879	....	....	....	....



## ENVOY

02-09	Todos		G51718	....	....	143241 <sup>53</sup>	....		....	61717	....	....	....
	Coil(RearSpringType)		G51718	....	....	143241 <sup>53</sup>	....		G63842	61717	77971	....	....
03-06	Air(RearSpringType)		G51718	....	....	143241 <sup>53</sup>	....		G64014	61717	....	....	....



























## ENVOY XL

02-06	Todos		....	....	....	....	....		....	....	77971	....	....
-------	-------	---	------	------	------	------	------	---	------	------	-------	------	------

## ENVOY XUV

04-05	Todos		....	....	....	....	....		....	....	77971	....	....
-------	-------	---	------	------	------	------	------	---	------	------	-------	------	------

## JIMMY

05	Todos		....	....	....	....	....		G63422	81482	58422 77422	....	....
	4WD		G63423	61531 81516	58423 <sup>50</sup> 77423	142316 <sup>53</sup>	....		G63422	61528 81482	58422 77422	....	43162 <sup>8</sup> 49213 <sup>7</sup>
92-04	Todos		....	....	....	142316 <sup>53</sup>	....		G63422	61528 81482	58422 77422	....	43162 <sup>8</sup> 49213 <sup>7</sup>
	4WD		G63423	61531 81516	58423 <sup>50</sup> 77423	142316 <sup>53</sup>	....		G63422	61528 81482	58422 77422	....	43162 <sup>8</sup> 49213 <sup>7</sup>
	RWD		G63421	61504 81750	58421 77421	142316 <sup>53</sup>	34051 <sup>8</sup>		G63422	61528 81482	58422 77422	....	43162 <sup>8</sup> 49213 <sup>7</sup>
73-91	Exc. Kit de Levantamiento		....	....	....	....	....		G63349	61524 81164	77349	....	43111 <sup>8</sup> 49155 <sup>7</sup>
	4WD; Con Kit de Levantamiento de 4"; Exc. Suspensión Quad		G63437 <sup>50</sup>	....	58437 <sup>50</sup>	....	....		G63438 <sup>50</sup>	....	58438 <sup>50</sup>	....	....
	4WD; Exc. Suspensión Quad y Kit de Elevación		G63347 <sup>50</sup>	61516 81113	58347	....	43107 <sup>8</sup>		....	....	58349	....	....
	4WD; Suspensión Quad Amortiguador Corto; Exc. Kit de Levantamiento		G63908 <sup>6</sup>	....	58908 <sup>6</sup>	....	....		....	....	....	....	....
73-84	RWD		G63355	61525 81039	58355 77355	....	34036 <sup>8</sup>		....	....	....	....	....
	4WD		....	....	....	....	....		G63371	....	....	....	43062 <sup>8</sup> 49107 <sup>7</sup>
70-72	4WD; Exc. Suspensión Quad y Kit de Elevación		G63347 <sup>50</sup>	61516 81113	58347	....	43107 <sup>8</sup>		....	....	....	....	....
	RWD		G63355	61525 81039	58355 77355	....	34036 <sup>8</sup>		G63306	82003	....	....	43093 <sup>8</sup> 49162 <sup>7</sup>

## JIMMY ESTABILIZADORES DE DIRECCIÓN

		Delantero	Trasero
84-04	4WD, Power Steering Estabilizador de Dirección Sistema Sencillo; sin orificio de montaje de EO en brazo de dirección	6851SE	....
73-91	Amortiguador de reemplazo HD para vehículos con estabilizador de EO	6804SE <sup>80</sup>	....
	Amortiguador de reemplazo para vehículos con el kit de montaje de repuesto GRC	6802SE <sup>84</sup>	....
	Amortiguador de reemplazo para vehículos con estabilizador de EO	14017	....
	Sin Estabilizador de Dirección de EO	6849SE <sup>82</sup>	....
70-72	4WD; Estabilizador de Dirección Sistema Dual K5	6802SE <sup>84</sup>	....
	4WD; Estabilizador de Dirección Sistema Sencillo K-5	6803SE <sup>84</sup>	....

6 Se recomienda que cuando se reemplacen amortiguadores "quad", los 4 sean de la misma serie.

8 Paquetes en pares

53 Montaje de Strut. Es probable reutilizar algunas partes del E.O.

82 Use kit si está señalado. Vea Ref. C para Botas.



7 Paquetes en pares; kit de mangueras de aire incluido

50 Para proteger la barra del pistón, se recomienda utilizar el kit Bellows No.141242.

80 No requiere soportes para el montaje, instalar sobre montajes de EO Vea Ref. C para Botas.

84 Amortiguador de repuesto para los vehículos con el kit de montaje aftermarket GRC

# AMORTIGUADORES Y STRUTS

Año	Notas de Aplicación										
		Ultra	ProGuard\ Guardian	Max Control\ LTV	Protector de Strut\ Bases de Strut	HiJacker\ Soporte\ Hidráulico	Ultra	ProGuard\ Guardian	Max Control\ LTV	Protector de Strut\ Bases de Strut	HiJacker\ Soporte\ Hidráulico



























**GMC**

**GMC**

## JIMMY ESTABILIZADORES DE DIRECCIÓN (cont)

		Delantero	Trasero
70-72	RWD	6802SE <sup>84</sup>	....























### PICKUP 1/2 TON, C15 / C1500

88-99	Todos	 G63489	61544 81668	58489 77489	....	....	 G63488	61543 81667	58488 77488	....	43163 <sup>8</sup> 49218 <sup>7</sup>
88-90	5.7L MFI	 G63489	61544 81668	58489 77489	....	42961	 G63488	61543 81667	58488 77488	....	42958 43163 <sup>8</sup> 49218 <sup>7</sup>
73-86	Todos	 G63355	61525 81039	58355 77355	....	34036 <sup>8</sup>	 G63349	61524 81164	58349 77349	....	43111 <sup>8</sup> 49155 <sup>7</sup>
86	4.8L DOHC, MFI	 G63355	61525 81039	58355 77355	....	42961 34036 <sup>8</sup>	 G63349	61524 81164	58349 77349	....	43111 <sup>8</sup> 49155 <sup>7</sup>
82-85	4.8L DOHC, MFI	 G63355	61525 81039	58355 77355	....	42961 34036 <sup>8</sup>	 G63349	61524 81164	58349 77349	....	42958 43111 <sup>8</sup> 49155 <sup>7</sup>
81-84	5.7L MFI	 G63355	61525 81039	58355 77355	....	42961 34036 <sup>8</sup>	 G63349	61524 81164	58349 77349	....	42958 43111 <sup>8</sup> 49155 <sup>7</sup>
80-84	4.1L 4BBL	 G63355	61525 81039	58355 77355	....	34036 <sup>8</sup>	 G63349	61524 81164	58349 77349	....	42958 43111 <sup>8</sup> 49155 <sup>7</sup>
	4.1L 4bbl	 G63355	61525 81039	58355 77355	....	42961 34036 <sup>8</sup>	 G63349	61524 81164	58349 77349	....	43111 <sup>8</sup> 49155 <sup>7</sup>
81	4.8L DOHC, MFI	 G63355	61525 81039	58355 77355	....	42961 34036 <sup>8</sup>	 G63349	61524 81164	58349 77349	....	43111 <sup>8</sup> 49155 <sup>7</sup>
68-72	Resorte Trasero	 G63355	61525 81039	58355 77355	....	34036 <sup>8</sup>	 .....	82003	....	....	49107 43062 <sup>8</sup>
67-72	Todos	 G63355	61525 81039	58355 77355	....	34036 <sup>8</sup>	 .....	....	....	....	43062 <sup>8</sup>
	Resorte Trasero de Hojas Múltiples	 G63355	61525 81039	58355 77355	....	34036 <sup>8</sup>	 .....	82006	....	....	49162 <sup>7</sup> 43062 <sup>8</sup>
	RWD; Resorte Trasero de Hojas Múltiples	 G63355	61525 81039	58355 77355	....	34036 <sup>8</sup>	 G63306	....	....	....	43062 <sup>8</sup>
67	Resorte Trasero	 G63355	61525 81039	58355 77355	....	34036 <sup>8</sup>	 .....	82003	....	....	49107 <sup>7</sup> 43062 <sup>8</sup>

### PICKUP 1/2 TON, C15 / C1500 ESTABILIZADORES DE DIRECCIÓN

		Delantero	Trasero
88-99	RWD	6852SE <sup>82</sup>	....
73-86	Estabilizador de Dirección Sistema Sencillo	6802SE <sup>84</sup>	....

### PICKUP 1/2 TON, K15 / K1500

88-99	Todos	 G63818	....	58901 77609	....	....	 G63488	61543 81667	58488 <sup>50</sup> 77488	....	43163 <sup>8</sup> 49218 <sup>7</sup>
81-86	Suspensión Quad Amortiguador Corto; Exc. Kit de Levantamiento	 G63908 <sup>6</sup>	....	58908 <sup>6</sup>	....	....	 .....	....	....	....	....
	Suspensión Quad Amortiguador Largo; Exc. Kit de Levantamiento	 G63906 <sup>6</sup>	61522 <sup>6</sup> 81496 <sup>6</sup>	58906 <sup>6</sup>	....	....	 .....	....	....	....	....
75-86	Exc. Suspensión Quad y Kit de Levantamiento	 G63347	61516 81113	58347	....	43107 <sup>8</sup>	 .....	....	58349	....	43111 <sup>8</sup> 49155 <sup>7</sup>
73-86	Con Kit de Levantamiento de 4"; Exc. Suspensión Quad	 G63437 <sup>50</sup>	....	58437 <sup>50</sup>	....	....	 G63438 <sup>50</sup>	....	58438 <sup>50</sup>	....	....
	Exc. Kit de Levantamiento	 .....	....	....	....	....	 G63349	61524 81164	77349	....	....
73-74	Exc. Suspensión Quad y Kit de Levantamiento	 G63347	61516 81113	58347	....	43107 <sup>8</sup>	 .....	....	58349	....	49155 <sup>7</sup>
71-72	Todos	 .....	....	....	....	43107 <sup>8</sup>	 G63371	....	....	....	....
	Exc. Suspensión Quad y Kit de Levantamiento	 G63347	61516 81113	58347	....	43107 <sup>8</sup>	 G63371	....	....	....	....
69-70	Todos	 .....	....	....	....	43107 <sup>8</sup>	 .....	....	....	....	....
	Exc. Suspensión Quad y Kit de Levantamiento	 G63347	61516 81113	58347	....	43107 <sup>8</sup>	 .....	....	....	....	....

6 Se recomienda que cuando se reemplacen amortiguadores "quad", los 4 sean de la misma serie.

8 Paquetes en pares

82 Use kit si está señalado. Vea Ref. C para Botas.





7 Paquetes en pares; kit de mangueras de aire incluido

50 Para proteger la barra del pistón, se recomienda utilizar el kit Bellows No.141242.

84 Amortiguador de repuesto para los vehículos con el kit de montaje aftermarket GRC



# AMORTIGUADORES Y STRUTS

Año	Notas de Aplicación										
			Ultra	ProGuard\ Guardian	Max Control\ LTV	Protector de Strut\ Bases de Strut	HiJacker\ Soporte\ Hidráulico		Ultra	ProGuard\ Guardian	Max Control\ LTV

**GMC**

**GMC**

## PICKUP 1/2 TON, K15 / K1500 ESTABILIZADORES DE DIRECCIÓN

		Delantero					Trasero				
88-99	Estabilizador de Dirección Sistema Sencillo	6807SE <sup>80</sup>					....				
73-86	Todos	14017					....				
	Estabilizador de Dirección Sistema Dual	6802SE <sup>84</sup>					....				
	Estabilizador de Dirección Sistema Sencillo	6804SE <sup>80</sup>					....				
69-72	Estabilizador de Dirección Sistema Dual	6802SE <sup>84</sup>					....				
	Estabilizador de Dirección Sistema Sencillo	6803SE <sup>84</sup>					....				

## PICKUP 1/2 TON, R1500

87	Todos	<input type="radio"/>	G63355	61525 81039	58355 77355	....	34036 <sup>8</sup>	<input type="radio"/>	G63349	61524 81164	58349 77349	....	43111 <sup>8</sup> 49155 <sup>7</sup>
----	-------	-----------------------	--------	----------------	----------------	------	--------------------	-----------------------	--------	----------------	----------------	------	--

## PICKUP 1/2 TON, R1500 ESTABILIZADORES DE DIRECCIÓN

		Delantero					Trasero				
87	Estabilizador de Dirección Sistema Sencillo	6802SE <sup>84</sup>					....				

## PICKUP 1/2 TON, V1500

87	Con Kit de Levantamiento de 4"; Exc. Suspensión Quad	<input type="radio"/>	G63437 <sup>50</sup>	....	58437 <sup>50</sup>	....	....	<input type="radio"/>	G63438 <sup>50</sup>	....	58438 <sup>50</sup>	....	....
	Exc. Kit de Levantamiento	<input type="radio"/>	G63347	....	....	....	43107 <sup>8</sup>	<input type="radio"/>	G63349	61524 81164	58349 77349	....	....
	Exc. Suspensión Quad y Kit de Levantamiento	<input type="radio"/>	....	....	58347	....	....	<input type="radio"/>	....	....	....	....	....
	Suspensión Quad Amortiguador Corto; Exc. Kit de Levantamiento	<input type="radio"/>	G63908 <sup>8</sup>	61516 81113 <sup>3</sup>	58908 <sup>6</sup>	....	....	<input type="radio"/>	....	....	....	....	....
	Suspensión Quad Amortiguador Largo; Exc. Kit de Levantamiento	<input type="radio"/>	G63906 <sup>6</sup>	61522 <sup>6</sup> 81496 <sup>6</sup>	58906 <sup>6</sup>	....	....	<input type="radio"/>	....	....	....	....	....
	Suspensión Quad Exc. Kit de Levantamiento	<input type="radio"/>	....	....	....	....	....	<input type="radio"/>	....	....	....	....	43111 <sup>8</sup> 49155 <sup>7</sup>

## PICKUP 1/2 TON, V1500 ESTABILIZADORES DE DIRECCIÓN

		Delantero					Trasero				
87	Todos	14017					....				
	Estabilizador de Dirección Sistema Dual	6802SE <sup>84</sup>					....				
	Estabilizador de Dirección Sistema Sencillo	6804SE <sup>80</sup>					....				

## PICKUP 3/4 TON, C25 / C2500

88-00	Todos	<input type="radio"/>	G63489	61544 81668	58489 77489	....	....	<input type="radio"/>	G63488	61543 81667	58488 77488	....	43163 <sup>8</sup> 49218 <sup>7</sup>
88-91	5.7L MFI	<input type="radio"/>	G63489	61544 81668	58489 77489	....	42961	<input type="radio"/>	G63488	61543 81667	58488 77488	....	42958 43163 <sup>8</sup> 49218 <sup>7</sup>
87	5.7L MFI	<input type="radio"/>	....	....	....	....	42961	<input type="radio"/>	....	....	....	....	42958
85-86	Crew Cab Pickup	<input type="radio"/>	....	....	58355 77355	....	34036 <sup>8</sup>	<input type="radio"/>	G63366	61649 81174	58366	....	....
82-86	Standard Cab Pickup	<input type="radio"/>	....	....	58355 77355	....	34036 <sup>8</sup>	<input type="radio"/>	G63349	61524 81164	58349 77349	....	43111 <sup>8</sup> 49155 <sup>7</sup>
79-86	Cab & Chassis	<input type="radio"/>	....	....	58355 77355	....	34036 <sup>8</sup>	<input type="radio"/>	G63349	61524 81164	58349 77349	....	43111 <sup>8</sup> 49155 <sup>7</sup>
	Exc. Extended Cab	<input type="radio"/>	G63355	61525 81039	....	....	....	<input type="radio"/>	....	....	....	....	....
79-83	Crew Cab Pickup	<input type="radio"/>	....	....	58355 77355	....	34036 <sup>8</sup>	<input type="radio"/>	G63366	61649 81174	58366	....	....
81	Crew Cab Pickup	<input type="radio"/>	....	....	....	....	34036 <sup>8</sup>	<input type="radio"/>	....	....	....	....	....
	Standard Cab Pickup	<input type="radio"/>	....	....	58355 77355	....	....	<input type="radio"/>	G63349	61524 81164	58349 77349	....	43111 <sup>8</sup> 49155 <sup>7</sup>
79-80	Standard Cab Pickup	<input type="radio"/>	....	....	58355 77355	....	34036 <sup>8</sup>	<input type="radio"/>	G63349	61524 81164	58349 77349	....	43111 <sup>8</sup> 49155 <sup>7</sup>
75-78	Cab & Chassis	<input type="radio"/>	....	....	....	....	....	<input type="radio"/>	....	61524 81164	58349 77349	....	43111 <sup>8</sup> 49155 <sup>7</sup>

6 Se recomienda que cuando se reemplacen amortiguadores "quad", los 4 sean de la misma serie.

8 Paquetes en pares

80 No requiere soportes para el montaje, instalar sobre montajes de EO Vea Ref. C para Botas.



7 Paquetes en pares; kit de mangueras de aire incluido

50 Para proteger la barra del pistón, se recomienda utilizar el kit Bellows No.141242.

84 Amortiguador de repuesto para los vehículos con el kit de montaje aftermarket

GRG

# AMORTIGUADORES Y STRUTS

Año	Notas de Aplicación										
		Ultra	ProGuard\ Guardian	Max Control\ LTV	Protector de Strut\ Bases de Strut	HiJacker\ Soporte\ Hidráulico	Ultra	ProGuard\ Guardian	Max Control\ LTV	Protector de Strut\ Bases de Strut	HiJacker\ Soporte\ Hidráulico

**GMC**

**GMC**

## PICKUP 3/4 TON, C25 / C2500 (cont)

75-78	Crew Cab Pickup	○	....	....	....	....	○	G63366	61649 81174	58366	....	....	
	Exc. Extended Cab	○	G63355	61525 81039	58355 77355	....	34036 <sup>6</sup>	○	G63349	....	....	....	
	Standard Cab Pickup	○	....	....	....	....	....	○	....	61524 81164	58349 77349	....	43111 <sup>8</sup> 49155 <sup>7</sup>
73-74	Todos	○	G63355	61525 81039	58355 77355	....	34036 <sup>6</sup>	○	....	....	....	....	43111 <sup>8</sup> 49155 <sup>7</sup>
	Crew Cab	○	G63355	61525 81039	58355 77355	....	34036 <sup>6</sup>	○	....	61649	....	....	43111 <sup>8</sup> 49155 <sup>7</sup>
	Crew Cab Pickup	○	G63355	61525 81039	58355 77355	....	34036 <sup>6</sup>	○	G63366	....	....	....	43111 <sup>8</sup> 49155 <sup>7</sup>
	Exc. Crew Cab & Bonus Cab	○	G63355	61525 81039	58355 77355	....	34036 <sup>6</sup>	○	G63349	61524 77349	58349 77349	....	43111 <sup>8</sup> 49155 <sup>7</sup>
67-72	Todos	○	G63355	61525 81039	58355 77355	....	34036 <sup>6</sup>	○	....	....	....	....	43062 <sup>2</sup>
	Resorte Trasero	○	G63355	61525 81039	58355 77355	....	34036 <sup>6</sup>	○	....	82003	....	....	49107 <sup>7</sup> 43062 <sup>8</sup>
	Resorte Trasero de Hojas Múltiples	○	G63355	61525 81039	58355 77355	....	34036 <sup>6</sup>	○	....	82006	....	....	49162 <sup>7</sup> 43062 <sup>8</sup>
	RWD; Resorte Trasero de Hojas Múltiples	○	G63355	61525 81039	58355 77355	....	34036 <sup>6</sup>	○	G63306	....	....	....	43062 <sup>8</sup>

## PICKUP 3/4 TON, C25 / C2500 ESTABILIZADORES DE DIRECCIÓN

		Delantero	Trasero
92-99	RWD, Exc. Estabilizador de Dirección de EO	6852SE <sup>82</sup>	....
88-91	RWD	6852SE <sup>82</sup>	....
67-86	Estabilizador de Dirección Sistema Sencillo	6802SE <sup>84</sup>	....

## PICKUP 3/4 TON, K25 / K2500

88-00	Todos	○	G63609	61542 81726	58609 77609	....	....	○	G63488	61543 81667	58488 77488	....	43163 <sup>8</sup> 49218 <sup>7</sup>
81-86	Suspensión Quad Amortiguador Corto; Exc. Kit de Levantamiento	○	G63908 <sup>6</sup>	....	58908 <sup>6</sup>	....	....	○	....	....	....	....	....
	Suspensión Quad Amortiguador Largo; Exc. Kit de Levantamiento	○	G63906 <sup>6</sup>	61522 <sup>6</sup> 81496 <sup>6</sup>	58906 <sup>6</sup>	....	....	○	....	....	....	....	....
73-86	Con Kit de Levantamiento de 4"; Exc. Suspensión Quad	○	G63437 <sup>50</sup>	....	58437 <sup>50</sup>	....	....	○	G63438 <sup>50</sup>	....	58438 <sup>50</sup>	....	....
86	Exc. Kit de Levantamiento	○	....	....	....	....	....	○	G63349	61524 81164	77349	....	43111 <sup>8</sup>
	Exc. Suspensión Quad y Kit de Levantamiento	○	G63347	61516 81113	58347	....	43107 <sup>6</sup>	○	....	....	58349	....	49155 <sup>7</sup>
73-85	Exc. Kit de Levantamiento	○	....	....	....	....	....	○	G63349	61524 81164	77349	....	....
	Exc. Suspensión Quad y Kit de Levantamiento	○	G63347	61516 81113	58347	....	43107 <sup>6</sup>	○	....	....	58349	....	43111 <sup>8</sup> 49155 <sup>7</sup>
71-72	Todos	○	....	....	....	....	....	○	G63371	....	....	....	....
	Exc. Suspensión Quad y Kit de Levantamiento	○	G63347	61516 81113	58347	....	43107 <sup>6</sup>	○	G63371	....	....	....	....
69-70	Exc. Suspensión Quad y Kit de Levantamiento	○	G63347	61516 81113	58347	....	43107 <sup>6</sup>	○	....	....	....	....	....

## PICKUP 3/4 TON, K25 / K2500 ESTABILIZADORES DE DIRECCIÓN

		Delantero	Trasero
99-00	4WD, PBV 9200 con Amortiguador de EO 15059138, 15155638	6853SE <sup>82</sup>	....
88-99	Estabilizador de Dirección Sistema Sencillo	6807SE <sup>80</sup>	....
73-86	Todos	14017	....
	Estabilizador de Dirección Sistema Dual	6802SE <sup>84</sup>	....
	Estabilizador de Dirección Sistema Sencillo	6804SE <sup>80</sup>	....
67-72	Estabilizador de Dirección Sistema Dual	6802SE <sup>84</sup>	....

6 Se recomienda que cuando se reemplacen amortiguadores "quad", los 4 sean de la misma serie.

8 Paquetes en pares

80 No requiere soportes para el montaje, instalar sobre montajes de EO. Vea Ref. C para Botas.





84 Amortiguador de repuesto para los vehículos con el kit de montaje aftermarket GRC

7 Paquetes en pares; kit de mangueras de aire incluido

50 Para proteger la barra del pistón, se recomienda utilizar el kit Bellows No. 141242.

82 Use kit si está señalado. Vea Ref. C para Botas.

# AMORTIGUADORES Y STRUTS

Año	Notas de Aplicación										
			Ultra	ProGuard\ Guardian	Max Control\ LTV	Protector de Strut\ Bases de Strut	HiJacker\ Soporte\ Hidráulico		Ultra	ProGuard\ Guardian	Max Control\ LTV



**GMC**

**GMC**

## PICKUP 3/4 TON, K25 / K2500 ESTABILIZADORES DE DIRECCIÓN (cont)

		Delantero					Trasero				
67-72	Estabilizador de Dirección Sistema Sencillo	6803SE <sup>84</sup>					....				











## PICKUP 3/4 TON, R2500

87-89	Crew Cab Pickup	....	....	....	....	....		G63366	61649 81174	58366	....	....
	Exc. Crew Cab & Bonus Cab		G63355	61525 81039	58355 77355	....	34036 <sup>8</sup>		G63349	61524 81164	58349 77349	....

## PICKUP 3/4 TON, R2500 ESTABILIZADORES DE DIRECCIÓN

		Delantero					Trasero				
87-89	Estabilizador de Dirección Sistema Sencillo	6802SE <sup>84</sup>					....				





















## PICKUP 3/4 TON, V2500

87	Con Kit de Levantamiento de 4"; Exc. Suspensión Quad		G63437 <sup>50</sup>	....	58437 <sup>50</sup>	....	....		G63438 <sup>50</sup>	....	58438 <sup>50</sup>	....	....
	Exc. Kit de Levantamiento		G63347	....	....	....	43107 <sup>8</sup>		G63349	61524 81164	58349 77349	....	43111 <sup>8</sup> 49155 <sup>7</sup>
	Exc. Suspensión Quad y Kit de Levantamiento		....	....	58347	....	....		....	....	....	....	....
	Suspensión Quad Amortiguador Corto; Exc. Kit de Levantamiento		G63908 <sup>8</sup>	61516 81113 <sup>6</sup>	58908 <sup>6</sup>	....	....		....	....	....	....	....
	Suspensión Quad Amortiguador Largo; Exc. Kit de Levantamiento		G63906 <sup>6</sup>	61522 <sup>6</sup> 81496 <sup>6</sup>	58906 <sup>6</sup>	....	....		....	....	....	....	....

## PICKUP 3/4 TON, V2500 ESTABILIZADORES DE DIRECCIÓN

		Delantero					Trasero				
87	Todos	14017					....				
	AN49	6802SE <sup>84</sup>					....				
	Estabilizador de Dirección Sistema Sencillo	6804SE <sup>80</sup>					....				

## PICKUP 1 TON, C35/3500

01-02	Todos	....	....	....	....	....		....	....	....	....	....	43163
	Eje Delantero Rígido	....	....	....	....	....		G63488	....	77488	....	....	43163
	Extended & Standard Cab; Eje Delantero Rígido HD	....	....	....	....	....		....	81667	....	....	....	43163
98-00	Eje Delantero Rígido HD		....	81668	....	....		....	....	77488	....	....	....
	Cab & Chassis Eje Delantero Rígido HD		G63812	....	....	....		....	....	58488 77488	....	....	49218 <sup>7</sup>
93-00	Standard Cab Pickup Eje Delantero Rígido HD		G63489	61544	58489	....	....		G63488	....	77488	....	....
92-00	Todos	....	....	....	....	....		....	....	77488	....	....	....
	Crew Cab Pickup Eje Delantero Rígido HD		G63489	61544	58489	....	....		G63488	....	77488	....	....
	Eje Delantero Rígido HD		....	....	58812	....	....		....	61543	77488	....	43163 <sup>8</sup>
	Exc. Cab & Chassis; Crew Cab y Eje Delantero Rígido HD		....	....	77489	....	....		....	81667	77488	....	....
	Extended Cab Pickup Eje Delantero Rígido HD		G63489	61544	58489	....	....		G63488	....	77488	....	....
92-97	Eje Delantero Rígido HD		....	81668	....	....		....	....	58488 77488	....	....	....
	Cab & Chassis Eje Delantero Rígido HD		G63812	....	....	....		....	....	77488	....	....	49218 <sup>7</sup>
92	Standard Cab Pickup Eje Delantero Rígido HD		G63489	61544	58489 77489	....	....		G63488	....	77488	....	....
91	Todos	....	....	....	....	....		....	....	77488	....	....	42958
	Eje Delantero Rígido HD		....	81668	....	....		....	....	58488 77488	....	....	49218 <sup>7</sup> 42958

6 Se recomienda que cuando se reemplacen amortiguadores "quad", los 4 sean de la misma serie.

8 Paquetes en pares

80 No requiere soportes para el montaje, instalar sobre montajes de EO Vea Ref. C para Botas.



7 Paquetes en pares; kit de mangueras de aire incluido

50 Para proteger la barra del pistón, se recomienda utilizar el kit Bellows No.141242.

84 Amortiguador de repuesto para los vehículos con el kit de montaje aftermarket

GRG

# AMORTIGUADORES Y STRUTS

Año	Notas de Aplicación										
		Ultra	ProGuard\ Guardian	Max Control\ LTV	Protector de Strut\ Bases de Strut	HiJacker\ Soporte\ Hidráulico	Ultra	ProGuard\ Guardian	Max Control\ LTV	Protector de Strut\ Bases de Strut	HiJacker\ Soporte\ Hidráulico

GMC

GMC

## PICKUP 1 TON, C35/3500 (cont)

91	5.7L MFI	○	....	....	....	....	42961	⊗	....	....	77488	....	42958
	Cab & Chassis	○	....	81039	77355	....	....	⊗	....	....	77488	....	42958
	Cab & Chassis Eje Delantero Rígido HD	○	G63812	61525	....	....	34036 <sup>8</sup>	⊗	....	....	77488	....	42958
	Cab & Chassis Exc. Eje Rígido Delantero HD	○	....	....	....	....	....	⊗	G63366	61649 81174	58366 77488	....	42958
	Eje Delantero Rígido HD	○	....	....	58812	....	....	⊗	....	61543	77488	....	43163 <sup>8</sup> 42958
	Exc. Cab & Chassis; Crew Cab y Eje Delantero Rígido HD	○	....	....	....	....	....	⊗	....	81667	77488	....	42958
	Extended Cab Pickup Eje Delantero Rígido HD	⊕	G63489	61544	58489 77489	....	....	⊗	G63488	....	77488	....	42958
	Standard Cab Pickup Eje Delantero Rígido HD	⊕	G63489	61544	58489 77489	....	....	⊗	G63488	....	77488	....	42958
89-90	Exc. Cab & Chassis; Crew Cab y Eje Delantero Rígido HD	○	....	....	....	....	....	⊗	....	81667	....	....	42958
88-90	Todos	○	....	....	....	....	....	⊗	....	....	....	....	42958
	Eje Delantero Rígido HD	⊕	....	81668	....	....	....	⊗	....	....	58488	....	49218' 42958
	Cab & Chassis	○	....	81039	77355	....	34036 <sup>8</sup>	⊗	....	....	....	....	42958
	Cab & Chassis Eje Delantero Rígido HD	○	....	61525	58355	....	....	⊗	....	....	....	....	42958
	Cab & Chassis Exc. Eje Rígido Delantero HD	○	G63355	....	....	....	....	⊗	G63366	61649 81174	58366	....	42958
	Extended Cab Pickup Eje Delantero Rígido HD	⊕	G63489	61544	58489 77489	....	....	⊗	G63488	61543	77488	....	43163 <sup>8</sup> 42958
	Standard Cab Pickup Eje Delantero Rígido HD	⊕	G63489	61544	58489 77489	....	....	⊗	G63488	61543	77488	....	43163 <sup>8</sup> 42958
86-90	5.7L MFI	○	....	....	....	....	42961	⊗	....	....	....	....	42958
88	Exc. Cab & Chassis y Eje Delantero Rígido HD	○	....	....	....	....	....	⊗	....	81667	....	....	42958
81-85	5.7L MFI	○	....	61525	....	....	42961	⊗	....	....	....	....	42958
80-85	Todos	○	....	61525	....	....	....	⊗	....	....	....	....	....
80	5.7L MFI	○	....	61525	....	....	....	⊗	....	....	....	....	42958
73-78	Todos	○	G63355	61525 81039	58355 77355	....	34036 <sup>8</sup>	⊗	G63366	61649 81174	58366	....	....
67-72	Todos	○	G63355	61525 81039	58355 77355	....	34036 <sup>8</sup>	⊗	....	....	....	....	....
	Exc. Eje Trasero 11,000#	○	G63355	61525 81039	58355 77355	....	34036 <sup>8</sup>	⊗	G63306	82006	....	....	43093 <sup>8</sup> 49162' <sup>7</sup>

## PICKUP 1 TON, C35/3500 ESTABILIZADORES DE DIRECCIÓN

		Delantero	Trasero
91-93	Estabilizador de Dirección Sistema Sencillo Pickup HD	6807SE <sup>80</sup>	....
75-86	Crew Cab Pickup	6802SE <sup>84</sup>	....
72-74	Todos	6802SE <sup>84</sup>	....

## PICKUP 1 TON, K35 / K3500

88-00	Todos	○	G63609	61542 81726	58609 77609	....	....	⊗	G63488	61543 81667	58488 77488	....	43163 <sup>8</sup> 49218'
77-86	Todos	○	G63411	....	58411	....	....	⊗	G63675	61642 81921	58412 77412	....	....

## PICKUP 1 TON, K35 / K3500 ESTABILIZADORES DE DIRECCIÓN

		Delantero	Trasero
88-99	Estabilizador de Dirección Sistema Sencillo	6807SE <sup>80</sup>	....
77-86	Todos	14017	....
73-74	Todos	14017	....





7 Paquetes en pares; kit de mangueras de aire incluido

8 Paquetes en pares

80 No requiere soportes para el montaje, instalar sobre montajes de EO Ve a Ref. C para Botas.

84 Amortiguador de repuesto para los vehículos con el kit de montaje aftermarket GRC



# AMORTIGUADORES Y STRUTS

Año	Notas de Aplicación										
			Ultra	ProGuard/ Guardian	Max Control/ LTV	Protector de Strut/ Bases de Strut	HiJacker/ Soporte/ Hidráulico		Ultra	ProGuard/ Guardian	Max Control/ LTV





**GMC**

**GMC**

## PICKUP 1 TON, R3500

87-91	Todos		G63355	61525 81039	58355 77355	....	34036 <sup>8</sup>		G63366	61649 81174	58366	....	....
-------	-------	---	--------	----------------	----------------	------	--------------------	---	--------	----------------	-------	------	------





## PICKUP 1 TON, V3000 / V3500

87-91	Todos		G63411	....	58411	....	....		G63675	61642 81921	58412 77412	....	....
87-88	Suspensión Quad Amortiguador Largo; Exc. Kit de Levantamiento		G63411	81496 <sup>6</sup>	58411	....	....		G63675	61642 81921	58412 77412	....	....



## PICKUP 1 TON, V3000 / V3500 ESTABILIZADORES DE DIRECCIÓN

										Delantero	Trasero
87-91	Todos									14017	....











## PICKUP 1500 SERIES

63-65	Todos		G63355	61525 81039	58355 77355	....	34036 <sup>8</sup>		G63306	82006	....	....	43093 <sup>8</sup> 49162 <sup>7</sup>
61-62	Todos		....	82035	....	....	....		....	82086	....	....	....

## PICKUP 2500 SERIES

61-62	Todos		....	82035	....	....	....		....	....	....	....	....
-------	-------	---	------	-------	------	------	------	---	------	------	------	------	------









## S15 JIMMY

83-05	Todos		....	....	....	....	....		....	....	....	....	70173
	RWD		....	....	....	....	70171		....	....	....	....	70173
83-91	Todos		....	....	....	142316 <sup>53</sup>	....		G63422	61528 81482	58422 77422	....	43162 <sup>8</sup> 49213 <sup>7</sup> 70173
	4WD		G63423	61531 81516	58423 77423	....	....		....	....	....	....	70173
	RWD		G63421	61504 81750	58421 77421	....	34051 <sup>8</sup>		....	....	....	....	70173











## S15 JIMMY ESTABILIZADORES DE DIRECCIÓN

										Delantero	Trasero
83-91	Estabilizador de Dirección Sistema Sencillo; con orificio de montaje de EO en brazo de dirección									6801SE	....

## SAFARI

90-05	Todos		....	....	....	....	....		G63454	61539 81581	77454	....	43161 <sup>8</sup> 49215 <sup>7</sup>
	AWD		G63818	61542 81726	58609 77609	....	....		G63454	61539 81581	77454	....	43161 <sup>8</sup> 49215 <sup>7</sup>
	RWD		G63375 <sup>5</sup>	61555 81713 <sup>5</sup>	77375	....	....		G63454	61539 81581	77454	....	43161 <sup>8</sup> 49215 <sup>7</sup>
85-89	RWD		G63375 <sup>5</sup>	61555 81713 <sup>5</sup>	77375	....	....		G63454	61539 81581	77454	....	43161 <sup>8</sup> 49215 <sup>7</sup>

## SIERRA 1500

14	Todos		G51949	....	....	....	....		....	....	....	....	....
	Exc. Modelos Classic y Suspensión Electrónica Ajustable		G51949	....	....	....	....		G63959	....	....	....	....
07-13	Exc. Modelos Classic y Suspensión Electrónica Ajustable		G51870	....	....	143316 <sup>53</sup>	....		G63959	61690	....	....	....
99-07	4WD; Classic y Old Body Style; Exc. Suspensión Electrónica Ajustable		G63803	61643 81922	58803 77803	....	....		G63675	61642 81921	58412 77412	....	....
	RWD; Sólo Modelos Classic; Exc. Suspensión Electrónica Ajustable		G63783	61641 81920	58783 77783	....	....		G63662	61600 81873	58662 77662	....	43181 <sup>8</sup> 49235 <sup>7</sup>

## SIERRA 1500 ESTABILIZADORES DE DIRECCIÓN

										Delantero	Trasero
99-05	4WD, Exc. Estabilizador de Dirección de EO									6853SE <sup>82</sup>	....

5 Use el kit 140719 para reemplazar partes del EO de montaje inferior cuando los pernos se rompan o los tornillos autoroscantes no se puedan utilizar más.

7 Paquetes en pares; kit de mangueras de aire incluido



53 Montaje de Strut. Es probable reutilizar algunas partes del E.O.

6 Se recomienda que cuando se reemplacen amortiguadores "quad", los 4 sean de la misma serie.

8 Paquetes en pares

82 Use kit si está señalado. Vea Ref. C para Botas.

# AMORTIGUADORES Y STRUTS

Año	Notas de Aplicación										
		Ultra	ProGuard\ Guardian	Max Control\ LTV	Protector de Strut\ Bases de Strut	HiJacker\ Soporte\ Hidráulico	Ultra	ProGuard\ Guardian	Max Control\ LTV	Protector de Strut\ Bases de Strut	HiJacker\ Soporte\ Hidráulico

**GMC**

**GMC**

## SIERRA 1500 HD

05-07	Todos	⊕ ○	G63817	61663 81925	58817 77817	....	....	⊕ ○	G63675	61642 81921	58412 77412	....	....
01-03	Todos	⊕ ○	G63817	61663 81925	58817 77817	....	....	⊕ ○	G63675	61642 81921	58412 77412	....	....

## SIERRA 2500

99-04	Todos	⊕ ○	....	....	58817	....	....	⊕ ○	G63675	61642 81921	58412 77412	....	....
	4WD	⊕ ○	G63817	61663 81925	77817 58817	....	....	⊕ ○	G63675	61642 81921	58412 77412	....	....

### SIERRA 2500 ESTABILIZADORES DE DIRECCIÓN

								Delantero		Trasero			
99-04	4WD, Hasta PBV 8600#, Exc. Estabilizador de Dirección de EO							6853SE <sup>82</sup>		....			

## SIERRA 2500 HD

01-10	Todos	⊕ ○	G63817	61663 81925	58817 77817	....	....	⊕ ○	G63675	61642 81921	58412 77412	....	....
-------	-------	--------	--------	----------------	----------------	------	------	--------	--------	----------------	----------------	------	------

### SIERRA 2500 HD ESTABILIZADORES DE DIRECCIÓN

								Delantero		Trasero			
11-13	Todos							14075		....			
01-09	4WD, PBV 9200 con Amortiguador de EO 15059138, 15155638							6853SE <sup>82</sup>		....			

## SIERRA 3500

01-07	Todos	⊕ ○	G63817	61663 81925	58817 77817	....	....	⊕ ○	G63675	61642 81921	58412 77412	....	....
-------	-------	--------	--------	----------------	----------------	------	------	--------	--------	----------------	----------------	------	------

## SIERRA 3500 HD

07-10	Todos	⊕ ○	....	....	....	....	....	⊕ ○	G63675	61642 81921	58412 77412	....	....
	Barra de Torsion(FrontSpringType)	⊕ ○	G63817	61663 81925	58817 77817	....	....	⊕ ○	G63675	61642 81921	58412 77412	....	....

### SIERRA 3500 HD ESTABILIZADORES DE DIRECCIÓN

								Delantero		Trasero			
11-13	Todos							14075		....			

## SONOMA / S15

83-04	4WD	⊕ ○	G63423	61531 81516	58423 77423	....	....	⊕ ○	G63422	61528 81482	58422 77422	....	43162 <sup>8</sup> 49213 <sup>7</sup>
82-04	Todos	⊕ ○	....	....	....	....	....	⊕ ○	G63422	61528 81482	58422 77422	....	43162 <sup>8</sup> 49213 <sup>7</sup>
	RWD	⊕ ○	G63421	61504 81750	58421 77421	....	34051 <sup>8</sup>	⊕ ○	G63422	61528 81482	58422 77422	....	43162 <sup>8</sup> 49213 <sup>7</sup>
88-94	4WD, Barra de Torsion(FrontSpringType)	⊕ ○	....	....	....	142316 <sup>53</sup>	....	⊕ ○	G63422	61528 81482	58422 77422	....	43162 <sup>8</sup> 49213 <sup>7</sup>

### SONOMA / S15 ESTABILIZADORES DE DIRECCIÓN

								Delantero		Trasero			
91-93	Estabilizador de Dirección Sistema Sencillo; con orificio de montaje de EO en brazo de dirección							6801SE <sup>80</sup>		....			
82-93	RWD, Estabilizador de Dirección Sistema Sencillo							6802SE <sup>84</sup>		....			
83-90	4WD, Power Steering Estabilizador de Dirección Sistema Sencillo; sin orificio de montaje de EO en brazo de dirección							6851SE		....			
82-90	RWD							6849SE <sup>82</sup>		....			
	RWD, Estabilizador de Dirección Sistema Sencillo; con orificio de montaje de EO en brazo de dirección							6801SE		....			

## SUBURBAN 1/2 TON, C15 / C1500

93-99	Todos	⊕ ○	G63489	61544 81668	58489 77489	....	....	⊕ ○	G63896	61565 81789	58638 77638	....	43180 <sup>8</sup> 49231 <sup>7</sup>
92	Todos	⊕ ○	G63489	61544 81668	58489 77489	....	....	⊕ ○	....	61565 81789	58638 77638	....	43180 <sup>8</sup> 49231 <sup>7</sup>
	Old Body Style	⊕ ○	G63489	61544 81668	58489 77489	....	....	⊕ ○	G63896	61565 81789	58638 77638	....	43180 <sup>8</sup> 49231 <sup>7</sup>
75-86	Todos	⊕ ○	G63355	61525 81039	58355 77355	....	34036 <sup>8</sup>	⊕ ○	G63349	61524 81164	58349 77349	....	43111 <sup>8</sup> 49155 <sup>7</sup>
73-74	Todos	⊕ ○	G63355	81039	58355 77355	....	34036 <sup>8</sup>	⊕ ○	G63349	61524 81164	58349 77349	....	43111 <sup>8</sup> 49155 <sup>7</sup>

7 Paquetes en pares; kit de mangueras de aire incluido

53 Montaje de Strut. Es probable reutilizar algunas partes del E.O.





82 Use kit si está señalado. Vea Ref. C para Botas.

8 Paquetes en pares

80 No requiere soportes para el montaje, instalar sobre montajes de EO Vea Ref. C para Botas.

84 Amortiguador de repuesto para los vehículos con el kit de montaje aftermarket GRC

# AMORTIGUADORES Y STRUTS

Año	Notas de Aplicación										
			Ultra	ProGuard\ Guardian	Max Control\ LTV	Protector de Strut\ Bases de Strut	HiJacker\ Soporte\ Hidráulico		Ultra	ProGuard\ Guardian	Max Control\ LTV

**GMC**

**GMC**

## SUBURBAN 1/2 TON, C15 / C1500 (cont)

73-74	Resortes Helicoidales Delanteros	<input type="radio"/>	G63355	61525 81039	58355 77355	....	34036 <sup>8</sup>	<input type="radio"/>	G63349	61524 81164	58349 77349	....	43111 <sup>8</sup> 49155 <sup>7</sup>
68-72	Todos	<input type="radio"/>	G63355	....	58355 77355	....	34036 <sup>8</sup>	<input type="radio"/>	....	....	....	....	43062 <sup>8</sup>
	Coil (FrontSpringType)	<input type="radio"/>	G63355	81039	58355 77355	....	34036 <sup>8</sup>	<input type="radio"/>	....	....	....	....	43062 <sup>8</sup>
	Resorte Trasero	<input type="radio"/>	G63355	....	58355 77355	....	34036 <sup>8</sup>	<input type="radio"/>	....	82003	....	....	49107 <sup>7</sup> 43062 <sup>8</sup>
	Resortes Helicoidales Delanteros	<input type="radio"/>	G63355	61525	58355 77355	....	34036 <sup>8</sup>	<input type="radio"/>	....	....	....	....	43062 <sup>8</sup>

## SUBURBAN 1/2 TON, C15 / C1500 ESTABILIZADORES DE DIRECCIÓN

		Delantero		Trasero	
92-99	RWD, Exc. Estabilizador de Dirección de EO	6852SE <sup>82</sup>		....	
68-86	Estabilizador de Dirección Sistema Sencillo	6802SE <sup>84</sup>		....	

## SUBURBAN 1/2 TON, K15 / K1500

92-99	Todos	<input type="radio"/>	G63609	61542 81726	58609 <sup>50</sup> 77609	....	....	<input type="radio"/>	G63638	61565 81789	58638 <sup>50</sup> 77638	....	43180 <sup>8</sup> 49231 <sup>7</sup>
85-86	Exc. Kit de Levantamiento	<input type="radio"/>	....	....	....	....	....	<input type="radio"/>	G63349	61524 81164	77349	....	....
	Exc. Suspensión Quad y Kit de Levantamiento	<input type="radio"/>	G63347	61516 81113	58347	....	43107 <sup>8</sup>	<input type="radio"/>	....	....	58349	....	43111 <sup>8</sup> 49155 <sup>7</sup>
81-86	Suspensión Quad Amortiguador Corto; Exc. Kit de Levantamiento	<input type="radio"/>	G63908 <sup>6</sup>	....	58908 <sup>6</sup>	....	....	<input type="radio"/>	....	....	....	....	....
	Suspensión Quad Amortiguador Largo; Exc. Kit de Levantamiento	<input type="radio"/>	G63906 <sup>6</sup>	61522 <sup>6</sup> 81496 <sup>6</sup>	58906 <sup>6</sup>	....	....	<input type="radio"/>	....	....	....	....	....
73-86	Con Kit de Levantamiento de 4"; Exc. Suspensión Quad	<input type="radio"/>	G63437 <sup>50</sup>	....	58437 <sup>50</sup>	....	....	<input type="radio"/>	G63438 <sup>50</sup>	....	58438 <sup>50</sup>	....	....
84	Exc. Kit de Levantamiento	<input type="radio"/>	....	....	....	....	....	<input type="radio"/>	G63349	61524 81164	77349	....	43111 <sup>8</sup>
	Exc. Suspensión Quad y Kit de Levantamiento	<input type="radio"/>	G63347	61516 81113	58347	....	43107 <sup>8</sup>	<input type="radio"/>	....	....	58349	....	49155 <sup>7</sup>
73-83	Exc. Kit de Levantamiento	<input type="radio"/>	....	....	....	....	....	<input type="radio"/>	G63349	61524 81164	77349	....	....
	Exc. Suspensión Quad y Kit de Levantamiento	<input type="radio"/>	G63347	61516 81113	58347	....	43107 <sup>8</sup>	<input type="radio"/>	....	....	58349	....	43111 <sup>8</sup> 49155 <sup>7</sup>
71-72	Todos	<input type="radio"/>	....	....	....	....	....	<input type="radio"/>	G63371	....	....	....	....
	Exc. Suspensión Quad y Kit de Levantamiento	<input type="radio"/>	G63347	61516 81113	58347	....	43107 <sup>8</sup>	<input type="radio"/>	G63371	....	....	....	....
69-70	Exc. Suspensión Quad y Kit de Levantamiento	<input type="radio"/>	G63347	61516 81113	58347	....	43107 <sup>8</sup>	<input type="radio"/>	....	....	....	....	....

## SUBURBAN 1/2 TON, K15 / K1500 ESTABILIZADORES DE DIRECCIÓN

		Delantero		Trasero	
92-95	Estabilizador de Dirección Sistema Sencillo	6807SE <sup>80</sup>		....	
73-86	Todos	14017		....	
	Estabilizador de Dirección Sistema Dual	6802SE <sup>84</sup>		....	
	Estabilizador de Dirección Sistema Sencillo	6804SE <sup>80</sup>		....	
68-72	Estabilizador de Dirección Sistema Dual	6802SE <sup>84</sup>		....	
	Estabilizador de Dirección Sistema Sencillo	6803SE <sup>84</sup>		....	

## SUBURBAN 1/2 TON, R1500

87-91	Todos	<input type="radio"/>	G63355	61525 81039	58355 77355	....	34036 <sup>8</sup>	<input type="radio"/>	G63349	61524 81164	58349 77349	....	43111 <sup>8</sup> 49155 <sup>7</sup>
-------	-------	-----------------------	--------	----------------	----------------	------	--------------------	-----------------------	--------	----------------	----------------	------	--

## SUBURBAN 1/2 TON, R1500 ESTABILIZADORES DE DIRECCIÓN

		Delantero		Trasero	
87-91	Estabilizador de Dirección Sistema Sencillo	6802SE <sup>84</sup>		....	

6 Se recomienda que cuando se reemplacen amortiguadores "quad", los 4 sean de la misma serie.

8 Paquetes en pares

80 No requiere soportes para el montaje, instalar sobre montajes de EO Vea Ref. C para Botas.



84 Amortiguador de repuesto para los vehículos con el kit de montaje aftermarket GRC

7 Paquetes en pares; kit de mangueras de aire incluido

50 Para proteger la barra del pistón, se recomienda utilizar el kit Bellows No.141242.

82 Use kit si está señalado. Vea Ref. C para Botas.

# AMORTIGUADORES Y STRUTS

Año	Notas de Aplicación										
		Ultra	ProGuard\ Guardian	Max Control\ LTV	Protector de Strut\ Bases de Strut	HiJacker\ Soporte\ Hidráulico	Ultra	ProGuard\ Guardian	Max Control\ LTV	Protector de Strut\ Bases de Strut	HiJacker\ Soporte\ Hidráulico

**GMC**

**GMC**

## SUBURBAN 1/2 TON, V1500

87-91	Con Kit de Levantamiento de 4"; Exc. Suspensión Quad	○ G63437 <sup>50</sup>	....	58437 <sup>50</sup>	....	....	○ G63438 <sup>50</sup>	....	58438 <sup>50</sup>	....	....
	Exc. Kit de Levantamiento	○ G63347	....	....	....	43107 <sup>8</sup>	○ G63349	61524 81164	58349 77349	....	43111 <sup>8</sup> 49155 <sup>7</sup>
	Exc. Suspensión Quad y Kit de Levantamiento	○ ....	....	58347	....	....	○ ....	....	....	....	....
	Suspensión Quad Amortiguador Corto; Exc. Kit de Levantamiento	○ G63908 <sup>6</sup>	61516 81113 <sup>6</sup>	58908 <sup>6</sup>	....	....	○ ....	....	....	....	....
	Suspensión Quad Amortiguador Largo; Exc. Kit de Levantamiento	○ G63906 <sup>6</sup>	61522 <sup>6</sup> 81496 <sup>6</sup>	58906 <sup>6</sup>	....	....	○ ....	....	....	....	....

## SUBURBAN 1/2 TON, V1500 ESTABILIZADORES DE DIRECCIÓN

		Delantero	Trasero
87-91	Todos	14017	....
	Estabilizador de Dirección Sistema Dual	6802SE <sup>84</sup>	....
	Estabilizador de Dirección Sistema Sencillo	6804SE <sup>80</sup>	....

## SUBURBAN 3/4 TON, C25 / C2500

92-99	Todos	○ G63489	61544 81668	58489 77489	....	....	○ G63896	61565 81789	58638 77638	....	43180 <sup>6</sup> 49231 <sup>7</sup>
75-86	Todos	○ G63355	61525 81039	58355 77355	....	34036 <sup>6</sup>	○ G63349	61524 81164	58349 77349	....	43111 <sup>8</sup> 49155 <sup>7</sup>
73-74	Todos	○ G63355	61525 81039	58355 77355	....	34036 <sup>6</sup>	○ ....	....	58349	....	43111 <sup>8</sup> 49155 <sup>7</sup>
	Exc. Crew Cab & Bonus Cab	○ G63355	61525 81039	58355 77355	....	34036 <sup>6</sup>	○ G63349	61524 81164	77349 58349	....	43111 <sup>8</sup> 49155 <sup>7</sup>
68-72	Todos	○ G63355	61525 81039	58355 77355	....	34036 <sup>6</sup>	○ ....	82003	....	....	43062 <sup>6</sup> 49107 <sup>7</sup>

## SUBURBAN 3/4 TON, C25 / C2500 ESTABILIZADORES DE DIRECCIÓN

		Delantero	Trasero
68-86	Estabilizador de Dirección Sistema Sencillo	6802SE <sup>84</sup>	....

## SUBURBAN 3/4 TON, K25 / K2500

92-99	Todos	○ G63609	61542 81726	58609 77609	....	....	○ G63638	61565 81789	58638 77638	....	43180 <sup>6</sup> 49231 <sup>7</sup>
81-86	Suspensión Quad Amortiguador Corto; Exc. Kit de Levantamiento	○ G63908 <sup>6</sup>	....	58908 <sup>6</sup>	....	....	○ ....	....	....	....	....
	Suspensión Quad Amortiguador Largo; Exc. Kit de Levantamiento	○ G63906 <sup>6</sup>	61522 <sup>6</sup> 81496 <sup>6</sup>	58906 <sup>6</sup>	....	....	○ ....	....	....	....	....
73-86	Con Kit de Levantamiento de 4"; Exc. Suspensión Quad	○ G63437 <sup>50</sup>	....	58437 <sup>50</sup>	....	....	○ G63438 <sup>50</sup>	....	58438 <sup>50</sup>	....	....
	Exc. Kit de Levantamiento	○ ....	....	....	....	....	○ G63349	61524 81164	77349	....	....
	Exc. Suspensión Quad y Kit de Levantamiento	○ G63347	61516 81113	58347	....	43107 <sup>8</sup>	○ ....	....	58349	....	43111 <sup>8</sup> 49155 <sup>7</sup>
71-72	Todos	○ ....	....	....	....	....	○ G63371	....	....	....	....
	Exc. Suspensión Quad y Kit de Levantamiento	○ G63347	61516 81113	58347	....	43107 <sup>8</sup>	○ G63371	....	....	....	....
69-70	Exc. Suspensión Quad y Kit de Levantamiento	○ G63347	61516 81113	58347	....	43107 <sup>8</sup>	○ ....	....	....	....	....

## SUBURBAN 3/4 TON, K25 / K2500 ESTABILIZADORES DE DIRECCIÓN

		Delantero	Trasero
92-97	Estabilizador de Dirección Sistema Sencillo	6807SE <sup>80</sup>	....
73-86	Todos	14017	....
	Estabilizador de Dirección Sistema Dual	6802SE <sup>84</sup>	....
	Estabilizador de Dirección Sistema Sencillo	6804SE <sup>80</sup>	....
68-72	Estabilizador de Dirección Sistema Dual	6802SE <sup>84</sup>	....
	Estabilizador de Dirección Sistema Sencillo	6803SE <sup>84</sup>	....

6 Se recomienda que cuando se reemplacen amortiguadores "quad", los 4 sean de la misma serie. 7 Paquetes en pares; kit de mangueras de aire incluido

50 Para proteger la barra del pistón, se recomienda utilizar el kit Bellows No.141242.





8 Paquetes en pares

84 Amortiguador de repuesto para los vehículos con el kit de montaje aftermarket GRC

80 No requiere soportes para el montaje, instalar sobre montajes de EO Vea Ref. C para Botas.





# AMORTIGUADORES Y STRUTS

Año	Notas de Aplicación										
			Ultra	ProGuard\ Guardian	Max Control\ LTV	Protector de Strut\ Bases de Strut	HiJacker\ Soporte\ Hidráulico		Ultra	ProGuard\ Guardian	Max Control\ LTV

**GMC**

**GMC**











## SUBURBAN 3/4 TON, R2500

87-91	Todos		G63355	61525 81039	58355 77355	....	34036 <sup>8</sup>		G63349	61524 81164	58349 77349	....	43111 <sup>6</sup> 49155 <sup>7</sup>
-------	-------	---	--------	----------------	----------------	------	--------------------	---	--------	----------------	----------------	------	--

### SUBURBAN 3/4 TON, R2500 ESTABILIZADORES DE DIRECCIÓN

										Delantero	Trasero		
87-91	Estabilizador de Dirección Sistema Sencillo									6802SE <sup>84</sup>	....		







## SUBURBAN 3/4 TON, V2500

87-91	Con Kit de Levantamiento de 4"; Exc. Suspensión Quad		G63437 <sup>50</sup>	....	58437 <sup>50</sup>	....	....		G63438 <sup>50</sup>	....	58438 <sup>50</sup>	....	....
	Exc. Kit de Levantamiento		G63347	....	....	....	43107 <sup>8</sup>		G63349	61524 81164	58349 77349	....	43111 <sup>6</sup> 49155 <sup>7</sup>
	Exc. Suspensión Quad y Kit de Levantamiento		....	....	58347	....	....		....	....	....	....	....
	Suspensión Quad Amortiguador Corto; Exc. Kit de Levantamiento		G63908 <sup>6</sup>	61516 81113 <sup>6</sup>	58908 <sup>6</sup>	....	....	....		....	....	....	....
	Suspensión Quad Amortiguador Largo; Exc. Kit de Levantamiento		G63906 <sup>6</sup>	61522 <sup>6</sup> 81496 <sup>6</sup>	58906 <sup>6</sup>	....	....	....		....	....	....	....

### SUBURBAN 3/4 TON, V2500 ESTABILIZADORES DE DIRECCIÓN

										Delantero	Trasero		
87-91	Todos									14017	....		
	Estabilizador de Dirección Sistema Dual									6802SE <sup>84</sup>	....		
	Estabilizador de Dirección Sistema Sencillo									6804SE <sup>80</sup>	....		



## SYCLONE

91	Todos		G63423	61531 81516	58423 77423	....	....		G63422	61528 81482	58422 77422	....	49213 <sup>7</sup>
	AWD		G63423	61531 81516	58423 77423	....	....		G63422	61528 81482	58422 77422	....	43162 <sup>8</sup> 49213 <sup>7</sup>
	Barra de Torsion(FrontSpringType)		G63423	61531 81516	58423 77423	142316 <sup>53</sup>	....	....		G63422	61528 81482	58422 77422	....

### SYCLONE ESTABILIZADORES DE DIRECCIÓN

										Delantero	Trasero		
91	Estabilizador de Dirección Sistema Sencillo; con orificio de montaje de EO en brazo de dirección									6801SE <sup>80</sup>	....		













## TYPHOON

92-93	Todos		G63423	61531 81516	58423 77423	142316 <sup>53</sup>	....		G63422	61528 81482	58422 77422	....	43162 <sup>8</sup> 49213 <sup>7</sup>
-------	-------	---	--------	----------------	----------------	----------------------	------	---	--------	----------------	----------------	------	--

### TYPHOON ESTABILIZADORES DE DIRECCIÓN

										Delantero	Trasero		
92-93	Estabilizador de Dirección Sistema Sencillo; sin orificio de montaje de EO en brazo de dirección									6851SE	....		

## VAN 1/2 TON, G / SAVANNA

08-11	Todos		....	....	....	....	....		G63896	61686	58638	....	43180 <sup>8</sup> 49231 <sup>7</sup>
	Barra de Torsión (Suspensión de Resorte Delantera)		G63893	....	....	....	....		G63896	61686	58638	....	43180 <sup>8</sup> 49231 <sup>7</sup>
	RWD		....	....	....	....	....		G63896	81789 61686	77638 58638	....	43180 <sup>8</sup> 49231 <sup>7</sup>
	RWD, Coil(FrontSpringType)		G63894	....	....	....	....		G63896	61686	58638	....	43180 <sup>8</sup> 49231 <sup>7</sup>
07	Todos		....	....	....	....	....		G63896	61686	....	....	43180 <sup>8</sup> 49231 <sup>7</sup>
	Barra de Torsión (Suspensión de Resorte Delantera)		G63893	....	....	....	....		G63896	61686	....	....	43180 <sup>8</sup> 49231 <sup>7</sup>
	RWD		....	....	....	....	....		G63896	81789 61686	77638	....	43180 <sup>8</sup> 49231 <sup>7</sup>
	RWD, Coil(FrontSpringType)		G63894	....	....	....	....		G63896	61686	....	....	43180 <sup>8</sup> 49231 <sup>7</sup>
03-06	Todos		....	....	....	....	....		G63896	61686	58638	....	43180 <sup>8</sup> 49231 <sup>7</sup>

6 Se recomienda que cuando se reemplacen amortiguadores "quad", los 4 sean de la misma serie.

8 Paquetes en pares

53 Montaje de Strut. Es probable reutilizar algunas partes del E.O.





84 Amortiguador de repuesto para los vehículos con el kit de montaje aftermarket GRC

7 Paquetes en pares; kit de mangueras de aire incluido

50 Para proteger la barra del pistón, se recomienda utilizar el kit Bellows No.141242.

80 No requiere soportes para el montaje, instalar sobre montajes de EO Vea Ref. C para Botas.























# AMORTIGUADORES Y STRUTS

Año	Notas de Aplicación										
			Ultra	ProGuard\ Guardian	Max Control\ LTV	Protector de Strut\ Bases de Strut	HiJacker\ Soporte\ Hidráulico		Ultra	ProGuard\ Guardian	Max Control\ LTV

**GMC**

**GMC**











## VAN 1/2 TON, G / SAVANNA (cont)

03-06	Barra de Torsión (Suspensión de Resorte Delantera)		G63893	61683	....	....	....		G63896	61686	58638	....	43180 <sup>6</sup> 49231 <sup>7</sup>
	RWD		....	....	....	....	....		G63896	81789 61686	77638 58638	....	43180 <sup>6</sup> 49231 <sup>7</sup>
	RWD, Coil(FrontSpringType)		G63894	61684	....	....	....		G63896	61686	58638	....	43180 <sup>6</sup> 49231 <sup>7</sup>
96-02	Todos		....	61555	....	....	....		G63896	61565	58638	....	43180 <sup>6</sup> 49231 <sup>7</sup>
	RWD		G63375 <sup>5</sup>	81713 <sup>5</sup> 61555	77375	....	....		G63896	81789 61565	77638 58638	....	43180 <sup>6</sup> 49231 <sup>7</sup>
78-95	Todos		G63357	61517 81108	58357 77357	....	....		G63413	61522 81496	58413 77413	....	49212 <sup>7</sup>
71-77	Todos		G63357	61517 81108	58357 77357	....	....		G63306	82006	....	....	43093 <sup>8</sup> 49162 <sup>7</sup>
70	Todos		....	....	58357	....	....		G63306	82006	....	....	43093 <sup>8</sup> 49162 <sup>7</sup>
	Eje Delantera con Viga en I		....	82062	58357	....	....		G63306	82006	....	....	43093 <sup>8</sup> 49162 <sup>7</sup>
	Suspensión Delantera Independiente		G63357	61517 81108	77357 58357	....	....		G63306	82006	....	....	43093 <sup>8</sup> 49162 <sup>7</sup>
67-69	Todos		....	82062	....	....	....		G63306	82006	....	....	43093 <sup>8</sup> 49162 <sup>7</sup>
64-66	Todos		....	82062	....	....	....		....	82003	....	....	....



















## VAN 1/2 TON, G / SAVANNA ESTABILIZADORES DE DIRECCIÓN

		Delantero	Trasero
70-95	Estabilizador de Dirección Sistema Sencillo	6802SE <sup>84</sup>	....

## VAN 1/2 TON, P SERIES

74-80	Todos		G63355	61525 81039	58355 77355	....	34036 <sup>6</sup>		G63366	61649 81174	58366 77662	....	....
73	Todos		G63355	61525 81039	58355 77355	....	34036 <sup>6</sup>		G63349	61524 81164	58349 77349	....	43111 <sup>8</sup> 49155 <sup>7</sup>
68-72	Todos		G63355	61525 81039	58355 77355	....	34036 <sup>6</sup>		....	82003	....	....	43062 <sup>8</sup>
	Resorte Trasero		G63355	61525 81039	58355 77355	....	34036 <sup>6</sup>		....	82003	....	....	49107 <sup>7</sup> 43062 <sup>8</sup>
67	Todos		G63355	61525 81039	58355 77355	....	34036 <sup>6</sup>		G63306	82006	....	....	43093 <sup>8</sup> 49162 <sup>7</sup>

## VAN 3/4 TON, G / SAVANNA

03-12	Todos		....	....	....	....	....		G63897	61687	77638	....	....
	Barra de Torsión (Suspensión de Resorte Delantera)		G63893	61683	....	....	....		G63897	61687	77638	....	....
	Coil(FrontSpringType)		G63895	61685	....	....	....		G63897	61687	77638	....	....
96-02	Exc. PBV 8600 #		G63375 <sup>5</sup>	61555 81713 <sup>5</sup>	77375	....	....		G63638	61565 81789	58638 77638	....	43180 <sup>6</sup> 49231 <sup>7</sup>
78-95	Exc. PBV 8600 #		G63357	61517 81108	58357 77357	....	....		G63413	61522 81496	58413 77413	....	49212 <sup>7</sup>
71-77	Todos		G63357	61517 81108	58357 77357	....	....		G63306	82006	....	....	43093 <sup>8</sup> 49162 <sup>7</sup>
70	Todos		....	....	....	....	....		G63306	82006	....	....	43093 <sup>8</sup> 49162 <sup>7</sup>
	Eje Delantera con Viga en I		....	82062	....	....	....		G63306	82006	....	....	43093 <sup>8</sup> 49162 <sup>7</sup>
	Suspensión Delantera Independiente		G63357	61517 81108	58357 77357	....	....		G63306	82006	....	....	43093 <sup>8</sup> 49162 <sup>7</sup>
67-69	Todos		....	82062	....	....	....		G63306	82006	....	....	43093 <sup>8</sup> 49162 <sup>7</sup>

## VAN 3/4 TON, G / SAVANNA ESTABILIZADORES DE DIRECCIÓN

		Delantero	Trasero
70-95	Estabilizador de Dirección Sistema Sencillo	6802SE <sup>84</sup>	....





5 Use el kit 140719 para reemplazar partes del EO de montaje inferior cuando los pernos se rompan o los tornillos autoroscantes no se puedan utilizar más.

7 Paquetes en pares; kit de mangueras de aire incluido

84 Amortiguador de repuesto para los vehículos con el kit de montaje aftermarket GRC

8 Paquetes en pares







# AMORTIGUADORES Y STRUTS

Año	Notas de Aplicación										
		 Ultra	ProGuard\ Guardian	Max Control\ LTV	Protector de Strut\ Bases de Strut	HiJacker\ Soporte\ Hidráulico	 Ultra	ProGuard\ Guardian	Max Control\ LTV	Protector de Strut\ Bases de Strut	HiJacker\ Soporte\ Hidráulico

**GMC**

**GMC**

## VAN 3/4 TON, P SERIES

79-89	Todos	 G63355	61525 81039	58355 77355	....	34036 <sup>8</sup>	 G63366	61649 81174	58366	....	....
73-78	Todos	 G63355	61525 81039	58355 77355	....	34036 <sup>8</sup>	 G63349	61524 81164	58349 77349	....	43111 <sup>8</sup> 49155 <sup>7</sup>
68-72	Todos	 G63355	61525 81039	58355 77355	....	34036 <sup>8</sup>	 G63306	82006	....	....	43093 <sup>8</sup> 49162 <sup>7</sup>
67	Todos	 .....	82047	....	....	....	....	....	....	....	....

## VAN 1 TON, G / SAVANNA

04-12	Todos	 .....	....	....	....	....	 .....	....	77638	....	....
	Barra de Torsión (Suspensión de Resorte Delantera)	 G63893	....	....	....	....	 .....	....	77638	....	....
	Con Rodado Sencillo	 .....	....	....	....	....	 .....	61687	77638	....	....
	Rodada Trasera Sencilla	 .....	....	....	....	....	 G63897	....	77638	....	....
	Coil(FrontSpringType)	 G63895	61685	....	....	....	 .....	....	77638	....	....
04-06	Doble Rodada Trasera	 .....	....	....	....	....	 G63898	61688	77638	....	....
03	Barra de Torsión (Suspensión de Resorte Delantera)	 G63893	....	....	....	....	 .....	....	....	....	....
	Con Rodado Sencillo	 .....	....	....	....	....	 .....	61687	....	....	....
	Doble Rodada Trasera	 .....	....	....	....	....	 G63898	61688	....	....	....
	Rodada Trasera Sencilla	 .....	....	....	....	....	 G63897	....	....	....	....
	Coil(FrontSpringType)	 G63895	61685	....	....	....	 .....	....	....	....	....
97-02	Todos	 G63375 <sup>5</sup>	61555 81713 <sup>5</sup>	77375	....	....	 .....	81789	....	....	43180 <sup>8</sup> 49231 <sup>7</sup>
	Exc. PBV 8600 #	 G63375 <sup>5</sup>	61555 81713 <sup>5</sup>	77375	....	....	 G63638	61565 81789	58638 77638	....	43180 <sup>8</sup> 49231 <sup>7</sup>
96	Todos	 G63375 <sup>5</sup>	61555 81713 <sup>5</sup>	58357 77375	....	....	 .....	....	....	....	43180 <sup>8</sup>
	7100, 7400, y 8600# PBV	 G63375 <sup>5</sup>	61555 81713 <sup>5</sup>	58357 77375	....	....	 .....	....	77638	....	43180 <sup>8</sup>
	Chassis Cab	 G63375 <sup>5</sup>	61555 81713 <sup>5</sup>	58357 77375	....	....	 .....	....	58671	....	43180 <sup>8</sup>
	Exc. PBV 8600 #	 G63375 <sup>5</sup>	61555 81713 <sup>5</sup>	58357 77375	....	....	 G63638	61565	58638 77638	....	43180 <sup>8</sup>
	Cutaway Van	 G63375 <sup>5</sup>	61555 81713 <sup>5</sup>	58357 77375	....	....	 G63671	....	....	....	43180 <sup>8</sup>
	Cutaway Van PBV 9200	 G63375 <sup>5</sup>	61555 81713 <sup>5</sup>	58357 77375	....	....	 G63403	....	....	....	43180 <sup>8</sup>
	Exc. Cutaway Van	 G63375 <sup>5</sup>	61555 81713 <sup>5</sup>	58357 77375	....	....	 G63413	61522 <sup>6</sup> 81496	58413	....	49212 <sup>7</sup> 43180 <sup>8</sup>
92-95	Chassis Cab	 G63357	61517 81108	58357 77357	....	....	 .....	....	58671	....	....
	Cutaway Van	 G63357	61517 81108	58357 77357	....	....	 G63671	....	58403	....	....
79-95	Cutaway Van PBV 9200	 G63357	61517 81108	58357 77357	....	....	 G63403	....	77403	....	....
	Exc. Cutaway Van	 G63357	61517 81108	58357 77357	....	....	 G63413	61522 <sup>6</sup> 81496	58413	....	49212 <sup>7</sup>
78-95	Todos	 G63357	61517 81108	58357 77357	....	....	 .....	....	....	....	....
79-91	Cutaway Van	 G63357	61517 81108	58357 77357	....	....	 .....	....	58403	....	....
78	Cutaway Van	 G63357	61517 81108	58357 77357	....	....	 G63413	61522 <sup>6</sup> 81496	58413	....	49212 <sup>7</sup>
76-77	Todos	 G63357	61517 81108	58357 77357	....	....	 G63306	82006	....	....	43093 <sup>8</sup> 49162 <sup>7</sup>
75	Todos	 .....	....	77357	....	....	 .....	....	....	....	....
	110.0(WheelBase)	 .....	61517	58357 77357	....	....	 G63306	82006	....	....	43093 <sup>8</sup> 49162 <sup>7</sup>



5 Use el kit 140719 para reemplazar partes del EO de montaje inferior cuando los pernos se rompan o los tornillos autoroscantes no se puedan utilizar más.

7 Paquetes en pares; kit de mangueras de aire incluido

6 Se recomienda que cuando se reemplacen amortiguadores "quad", los 4 sean de la misma serie.

8 Paquetes en pares

# AMORTIGUADORES Y STRUTS

Año	Notas de Aplicación										
		Ultra	ProGuard\ Guardian	Max Control\ LTV	Protector de Strut\ Bases de Strut	HiJacker\ Soporte\ Hidráulico	Ultra	ProGuard\ Guardian	Max Control\ LTV	Protector de Strut\ Bases de Strut	HiJacker\ Soporte\ Hidráulico

**GMC**

**GMC**

## VAN 1 TON, G / SAVANNA (cont)

75	125.0(WheelBase)	○	....	61517	58357 77357	....	....	○	G63306	82006	....	....	43093 <sup>8</sup> 49162 <sup>7</sup>
	146.0(WheelBase)	○	G63357	81108	77357	....	....	○	....	....	....	....	....
71-74	Todos	○	G63357	61517 81108	58357 77357	....	....	○	G63306	82006	....	....	....
	Exc. Base de rueda de 146"	○	G63357	61517 81108	58357 77357	....	....	○	G63306	82006	....	....	43093 <sup>8</sup> 49162 <sup>7</sup>

## VAN 1 TON, G / SAVANNA ESTABILIZADORES DE DIRECCIÓN

		Delantero	Trasero
94-95	Estabilizador de Dirección Sistema Sencillo HD c/ Eje Delantero Rígido & Tilt Hood	6804SE <sup>80</sup>	....
71-95	Estabilizador de Dirección Sistema Sencillo	6802SE <sup>84</sup>	....

## VAN 1 TON, P SERIES

92-99	Todos	○	....	....	....	....	....	○	G63366	61649 81174	58366 77662	....	....
	Chasis Motorhome c/ Eje de Viga Delantero en I	○	G63625	....	58625	....	....	○	G63366	61649 81174	58366 77662	....	....
	Chasis Motorhome c/ Suspensión Delantera Independiente	○	G63394	....	58394	....	....	○	G63366	61649 81174	58366 77662	....	....
91	Todos	○	....	61525 81039	....	....	....	○	G63366	61649 81174	58366 77662	....	....
	Chasis Motorhome c/ Eje de Viga Delantero en I	○	G63625	61525 81039	58625	....	....	○	G63366	61649 81174	58366 77662	....	....
	Chasis Motorhome c/ Suspensión Delantera Independiente	○	G63394	61525 81039	58394	....	....	○	G63366	61649 81174	58366 77662	....	....
	5.7L 8Cyl (350) SFI	○	....	81039 61525	....	....	....	○	G63366	81174 61649	58366 77662	....	....
86-90	Chasis Motorhome c/ Eje de Viga Delantero en I	○	G63625	....	58625	....	....	○	G63366	61649 81174	58366 77662	....	....
85-90	Chasis Motorhome c/ Suspensión Delantera Independiente	○	G63394	....	58394	....	....	○	G63366	61649 81174	58366 77662	....	....
75-90	Todos	○	....	....	....	....	....	○	G63366	61649 81174	58366 77662	....	....
	Exc. Chasis Motorhome	○	G63355	61525 81039	58355 77355	....	34036 <sup>8</sup>	○	G63366	61649 81174	58366 77662	....	....
85	Chasis Motorhome c/ Eje de Viga Delantero en I	○	G63403	....	58403 77403	....	....	○	G63366	61649 81174	58366 77662	....	....
75-84	Chasis Motorhome	○	G63394	....	58394	....	....	○	G63366	61649 81174	58366 77662	....	....
74	Todos	○	....	....	....	....	....	○	G63366	61649 81174	58366	....	....
	Base, Exc. Chasis Motorhome	○	....	81039	....	....	....	○	G63366	61649 81174	58366	....	....
	Chasis Motorhome	○	G63394	....	58394	....	....	○	G63366	61649 81174	58366	....	....
	Exc. Chasis Motorhome	○	G63355	61525	58355 77355	....	34036 <sup>8</sup>	○	G63366	61649 81174	77662 58366	....	....
73	Todos	○	....	....	....	....	....	○	G63366	61649	....	....	....
	Base, Exc. Chasis Motorhome	○	....	81039	....	....	....	○	G63366	81174 61649	58366	....	....
	Exc. Chasis Motorhome	○	G63355	61525	58355 77355	....	34036 <sup>8</sup>	○	G63366	61649	77662	....	....
68-72	Todos	○	G63355	61525 81039	58355 77355	....	34036 <sup>8</sup>	○	....	....	....	....	....
	Exc. Eje Trasero 11,000#	○	G63355	61525 81039	58355 77355	....	34036 <sup>8</sup>	○	G63306	82006	....	....	43093 <sup>8</sup> 49162 <sup>7</sup>
67	Todos	○	....	82047	....	....	....	○	....	....	....	....	....

## VAN 1 TON, P SERIES ESTABILIZADORES DE DIRECCIÓN

		Delantero	Trasero
79-93	Step Van Forward Control & Motorhome	6805SE <sup>80</sup>	....
75-78	Chasis Motorhome	6805SE <sup>80</sup>	....





7 Paquetes en pares; kit de mangueras de aire incluido

8 Paquetes en pares

80 No requiere soportes para el montaje, instalar sobre montajes de EO Veá Ref. C para Botas.

84 Amortiguador de repuesto para los vehículos con el kit de montaje aftermarket GRC



# AMORTIGUADORES Y STRUTS

Año	Notas de Aplicación										
			Ultra	ProGuard/ Guardian	Max Control/ LTV	Protector de Strut/ Bases de Strut	HiJacker/ Soporte/ Hidráulico		Ultra	ProGuard/ Guardian	Max Control/ LTV































**GMC**

**GMC**

## VAN, PB 1000 SERIES

63-65	Todos		G63355	61525 81039	58355 77355	....	34036 <sup>8</sup>		G63306	82006	....	....	43093 <sup>8</sup> 49162 <sup>7</sup>
-------	-------	---	--------	----------------	----------------	------	--------------------	---	--------	-------	------	------	--













## YUKON

12-14	Todos		....	....	....	....	....		G64101	....	....	....	....
	Exc. Suspensión Z55 o ZW7		G51891	....	....	....	....		G64101	....	....	....	....
12-13	Exc. Suspensión Electrónica Ajustable		....	....	....	143316 <sup>53</sup>	....		G64101	....	....	....	....
07-11	Exc. Suspensión Electrónica Ajustable		....	....	....	143316 <sup>53</sup>	....		....	....	....	....	....
	Exc. Suspensión Z55 o ZW7		G51891	....	....	....	....		G63866	61675 81930	58930 77953	....	....
00-06	Todos		....	....	....	....	....		....	....	....	....	49616
	Exc. Suspensión Z55 Auto Ride		G63803	61643 81922	58803 77803	....	....		G63866	61675 81930	77953	....	43182 49616
	Exc. Suspensión Z55 o ZW7		....	....	....	....	....		....	....	58930	....	49616
02	Denali, Exc. Suspensión Z55 Auto Ride		....	....	....	....	....		....	81930	....	....	49616
00	Denali		....	....	....	....	....		G63896	....	....	....	49616
92-99	Todos		....	....	....	....	....		G63896	61565 81789	58638 77638	....	43180 <sup>8</sup> 49231 <sup>7</sup>
	4WD		G63609	61542 81726	58901 77609	....	....		G63896	61565 81789	58638 77638	....	43180 <sup>8</sup> 49231 <sup>7</sup>
	RWD		G63489	61544 81668	58489 77489	....	....		G63896	61565 81789	58638 77638	....	43180 <sup>8</sup> 49231 <sup>7</sup>
99	Denali		....	61542 81726	58901 77609	....	....		G63896	61565 81789	58638 77638	....	43180 <sup>8</sup> 49231 <sup>7</sup>
	Denali, 4WD		....	....	....	....	....		G63896	81789 61565	58638 77638	....	49231 <sup>7</sup> 43180 <sup>8</sup>









## YUKON ESTABILIZADORES DE DIRECCIÓN

		Delantero		Trasero	
99-05	4WD	6853SE <sup>82</sup>		....	
95-99	RWD	6852SE <sup>82</sup>		....	

## YUKON XL 1/2 TON

12-14	Todos		....	....	....	....	....		G64101	....	....	....	....
	Exc. Suspensión Z55 o ZW7		G51891	....	....	....	....		G64101	....	....	....	....
12-13	Exc. Suspensión Z55 Auto Ride		....	....	....	143316 <sup>53</sup>	....		G64101	....	....	....	....
07-11	Exc. Suspensión Z55 Auto Ride		....	....	....	143316 <sup>53</sup>	....		....	61675	58930	....	....
	Exc. Suspensión Z55 o ZW7		G51891	....	....	....	....		G63866	....	77953	....	....
00-06	Exc. Suspensión Z55 Auto Ride		G63803	61643 81922	58803 77803	....	....		G63866	61675 81930	58930 77953	....	....

## YUKON XL 3/4 TON

07-11	Exc. Sistema de Autonivelación NIVOMAT		....	....	....	....	....		....	61675	58930	....	....
	Exc. Suspensión Z55 o ZW7		....	....	....	....	....		....	....	77953	....	....
00-06	Exc. Sistema de Autonivelación NIVOMAT		G63817	61663 81925	58817 77817	....	....		G63866	61675 81930	58930 77953	....	....
	Exc. Suspensión Z55 Auto Ride		....	81922	....	....	....		....	....	....	....	....



7 Paquetes en pares; kit de mangueras de aire incluido

53 Montaje de Strut. Es probable reutilizar algunas partes del E.O.

8 Paquetes en pares

82 Use kit si está señalado. Vea Ref. C para Botas.

# AMORTIGUADORES Y STRUTS

Año	Notas de Aplicación										
		Ultra	ProGuard\ Guardian	Max Control\ LTV	Protector de Strut\ Bases de Strut	HiJacker\ Soporte\ Hidráulico	Ultra	ProGuard\ Guardian	Max Control\ LTV	Protector de Strut\ Bases de Strut	HiJacker\ Soporte\ Hidráulico

## HONDA

## HONDA

### RIDGELINE

12	Todos	.....	.....	.....	.....	.....	.....	.....	.....	.....	.....	.....	.....	.....
11	Izquierdo	G52150	.....	.....	.....	.....	.....	.....	.....	.....	.....	.....	142230 <sup>53</sup>	.....
	Derecho	G52151	.....	.....	.....	.....	.....	.....	.....	.....	.....	.....	142230 <sup>53</sup>	.....
06-10	Izquierdo	G52150	.....	.....	.....	.....	.....	.....	.....	G51880	.....	.....	142230 <sup>53</sup>	.....
	Derecho	G52151	.....	.....	.....	.....	.....	.....	.....	G51880	.....	.....	142230 <sup>53</sup>	.....

## HUMMER

## HUMMER

### H2

03-06	Todos	G63817	61663	77817	.....	.....	G64000	.....	.....	.....	.....	.....	.....	.....
-------	-------	--------	-------	-------	-------	-------	--------	-------	-------	-------	-------	-------	-------	-------

### H3

06-10	Todos	G64001	.....	.....	.....	.....	G63965	.....	.....	.....	.....	.....	.....	.....
-------	-------	--------	-------	-------	-------	-------	--------	-------	-------	-------	-------	-------	-------	-------

## INTERNATIONAL

## INTERNATIONAL

### 100

74	Todos	.....	.....	.....	.....	.....	.....	82030	.....	.....	.....	.....	.....	.....
----	-------	-------	-------	-------	-------	-------	-------	-------	-------	-------	-------	-------	-------	-------

### 100 ESTABILIZADORES DE DIRECCIÓN

74	Todos								Delantero	Trasero
								6802SE <sup>84</sup>	.....	

### 150

75	RWD	.....	.....	.....	.....	.....	.....	82030	.....	.....	.....	.....	.....	.....
----	-----	-------	-------	-------	-------	-------	-------	-------	-------	-------	-------	-------	-------	-------

### 150 ESTABILIZADORES DE DIRECCIÓN

75	Todos								Delantero	Trasero
								6802SE <sup>84</sup>	.....	

### 200

74-75	Todos	.....	82030	.....	.....	.....	.....	82030	.....	.....	.....	.....	.....	.....
-------	-------	-------	-------	-------	-------	-------	-------	-------	-------	-------	-------	-------	-------	-------

### 200 ESTABILIZADORES DE DIRECCIÓN

74-75	Todos								Delantero	Trasero
								6802SE <sup>84</sup>	.....	

### 908B

68	Todos	.....	82007	.....	.....	.....	G63405	61500 81147	77405	.....	.....	43048 <sup>8</sup> 49310 <sup>7</sup>	.....	.....
----	-------	-------	-------	-------	-------	-------	--------	----------------	-------	-------	-------	--	-------	-------

### 908B ESTABILIZADORES DE DIRECCIÓN

68-69	Estabilizador de Dirección Sistema Sencillo 1/2 Ton, 3/4 Ton & Travelall								Delantero	Trasero
								6802SE <sup>84</sup>	.....	

### 908C

68	Todos	.....	82007	.....	.....	.....	G63405	61500 81147	77405	.....	.....	43048 <sup>8</sup> 49310 <sup>7</sup>	.....	.....
----	-------	-------	-------	-------	-------	-------	--------	----------------	-------	-------	-------	--	-------	-------

### 908C ESTABILIZADORES DE DIRECCIÓN

68-69	Estabilizador de Dirección Sistema Sencillo 1/2 Ton, 3/4 Ton & Travelall								Delantero	Trasero
								6802SE <sup>84</sup>	.....	

### 1000B

68	Todos	.....	82049	.....	.....	.....	.....	61500 81147	77405	.....	.....	43048 <sup>8</sup> 49310 <sup>7</sup>	.....	.....
	Exc. Travelette c/ base de rueda de 166"	.....	82049	.....	.....	.....	G63405	61500 81147	77405	.....	.....	43048 <sup>8</sup> 49310 <sup>7</sup>	.....	.....





### 1000B ESTABILIZADORES DE DIRECCIÓN

68-69	Estabilizador de Dirección Sistema Sencillo 1/2 Ton, 3/4 Ton & Travelall								Delantero	Trasero
								6802SE <sup>84</sup>	.....	

7 Paquetes en pares; kit de mangueras de aire incluido  
53 Montaje de Strut. Es probable reutilizar algunas partes del E.O.





8 Paquetes en pares  
84 Amortiguador de repuesto para los vehículos con el kit de montaje aftermarket GRC

# AMORTIGUADORES Y STRUTS

Año	Notas de Aplicación										
			Ultra	ProGuard\ Guardian	Max Control\ LTV	Protector de Strut\ Bases de Strut	HiJacker\ Soporte\ Hidráulico		Ultra	ProGuard\ Guardian	Max Control\ LTV

## INTERNATIONAL



### 1000C

68	Todos		....	82049	....	....	....		....	61500 81147	....	....	....	43048 <sup>8</sup> 49310 <sup>7</sup>
	Exc. Travelette c/ base de rueda de 166"		....	82049	....	....	....		G63405	61500 81147	77405	....	....	43048 <sup>8</sup> 49310 <sup>7</sup>

#### 1000C ESTABILIZADORES DE DIRECCIÓN

											Delantero	Trasero
68-69	Estabilizador de Dirección Sistema Sencillo 1/2 Ton, 3/4 Ton & Travelall										6802SE <sup>84</sup>	....





### 1000D

69-70	Antes de Chasis #H-205000		....	82049	....	....	....		....	82030	....	....	....
-------	---------------------------	---	------	-------	------	------	------	---	------	-------	------	------	------

#### 1000D ESTABILIZADORES DE DIRECCIÓN

											Delantero	Trasero
69-70	Estabilizador de Dirección Sistema Sencillo 1/2 Ton, 3/4 Ton & Travelall										6802SE <sup>84</sup>	....





### 1010

71-73	Todos		....	82049	....	....	....		....	....	....	....	....
71-72	Antes de Chasis #H-205000		....	82049	....	....	....		....	82030	....	....	....

#### 1010 ESTABILIZADORES DE DIRECCIÓN

											Delantero	Trasero
71-73	Estabilizador de Dirección Sistema Sencillo 1/2 Ton, 3/4 Ton & Travelall										6802SE <sup>84</sup>	....





### 1100B

68	Todos		....	82007	....	....	....		....	....	....	....	....
	Exc. Travelette c/ base de rueda de 166"		G63405	61500 81147 82007	77405	....	....		G63405	61500 81147	77405	....	43048 <sup>8</sup> 49310 <sup>7</sup>

#### 1100B ESTABILIZADORES DE DIRECCIÓN

											Delantero	Trasero
68-69	Estabilizador de Dirección Sistema Sencillo 1/2 Ton, 3/4 Ton & Travelall										6802SE <sup>84</sup>	....



### 1100C

68	Todos		....	82007	....	....	....		....	....	....	....	....
	Exc. Travelette c/ base de rueda de 166"		G63405	61500 81147 82007	77405	....	....		G63405	61500 81147	77405	....	43048 <sup>8</sup> 49310 <sup>7</sup>

#### 1100C ESTABILIZADORES DE DIRECCIÓN

											Delantero	Trasero
68-69	Estabilizador de Dirección Sistema Sencillo 1/2 Ton, 3/4 Ton & Travelall										6802SE <sup>84</sup>	....



### 1100D

69-70	Todos		....	82030	....	....	....		....	82030	....	....	....
-------	-------	---	------	-------	------	------	------	---	------	-------	------	------	------

#### 1100D ESTABILIZADORES DE DIRECCIÓN

											Delantero	Trasero
69-70	Estabilizador de Dirección Sistema Sencillo 1/2 Ton, 3/4 Ton & Travelall										6802SE <sup>84</sup>	....



### 1110

71-73	Todos		....	82030	....	....	....		....	82030	....	....	....
-------	-------	---	------	-------	------	------	------	---	------	-------	------	------	------

#### 1110 ESTABILIZADORES DE DIRECCIÓN

											Delantero	Trasero
71-73	Estabilizador de Dirección Sistema Sencillo 1/2 Ton, 3/4 Ton & Travelall										6802SE <sup>84</sup>	....

### 1200B

68	Exc. Travelette c/ base de rueda de 166"		G63405	61500 81147 82007	77405	....	....		G63405	61500 81147	77405	....	43048 <sup>8</sup> 49310 <sup>7</sup>
----	--	---	--------	-------------------------	-------	------	------	---	--------	----------------	-------	------	--

#### 1200B ESTABILIZADORES DE DIRECCIÓN



											Delantero	Trasero
68-69	Estabilizador de Dirección Sistema Sencillo 1/2 Ton, 3/4 Ton & Travelall										6802SE <sup>84</sup>	....

7 Paquetes en pares; kit de mangueras de aire incluido

8 Paquetes en pares





84 Amortiguador de repuesto para los vehículos con el kit de montaje aftermarket GRC

# AMORTIGUADORES Y STRUTS

Año	Notas de Aplicación										
		Ultra	ProGuard\ Guardian	Max Control\ LTV	Protector de Strut\ Bases de Strut	HiJacker\ Soporte\ Hidráulico	Ultra	ProGuard\ Guardian	Max Control\ LTV	Protector de Strut\ Bases de Strut	HiJacker\ Soporte\ Hidráulico

## INTERNATIONAL





### 1200C

68	Exc. Travelette c/ base de rueda de 166"	 	G63405	61500 81147 82007	77405	....	....	 	G63405	61500 81147	77405	....	43048 <sup>8</sup> 49310 <sup>7</sup>
----	--	---	--------	-------------------------	-------	------	------	---	--------	----------------	-------	------	--

#### 1200C ESTABILIZADORES DE DIRECCIÓN

										Delantero	Trasero	
68-69	Estabilizador de Dirección Sistema Sencillo 1/2 Ton, 3/4 Ton & Travelall										6802SE <sup>84</sup>	....





### 1200D

69-70	Todos	 	....	82030	....	....	....	 	....	82030	....	....	....
-------	-------	---	------	-------	------	------	------	---	------	-------	------	------	------

#### 1200D ESTABILIZADORES DE DIRECCIÓN

										Delantero	Trasero	
69-70	Estabilizador de Dirección Sistema Sencillo 1/2 Ton, 3/4 Ton & Travelall										6802SE <sup>84</sup>	....





### 1210

71-73	Todos	 	....	82030	....	....	....	 	....	82030	....	....	....
-------	-------	---	------	-------	------	------	------	---	------	-------	------	------	------

#### 1210 ESTABILIZADORES DE DIRECCIÓN

										Delantero	Trasero	
71-73	Estabilizador de Dirección Sistema Sencillo 1/2 Ton, 3/4 Ton & Travelall										6802SE <sup>84</sup>	....





### 1300B

68	Exc. Travelette c/ base de rueda de 166"	 	G63405	61500 81147 82007	77405	....	....	 	G63405	61500 81147	77405	....	43048 <sup>8</sup> 49310 <sup>7</sup>
----	--	---	--------	-------------------------	-------	------	------	---	--------	----------------	-------	------	--

#### 1300B ESTABILIZADORES DE DIRECCIÓN

										Delantero	Trasero	
68-69	Estabilizador de Dirección Sistema Sencillo 1/2 Ton, 3/4 Ton & Travelall										6802SE <sup>84</sup>	....





### 1300C

68	Exc. Travelette c/ base de rueda de 166"	 	G63405	61500 81147 82007	77405	....	....	 	G63405	61500 81147	77405	....	43048 <sup>8</sup> 49310 <sup>7</sup>
----	--	---	--------	-------------------------	-------	------	------	---	--------	----------------	-------	------	--

#### 1300C ESTABILIZADORES DE DIRECCIÓN

										Delantero	Trasero	
68-69	Estabilizador de Dirección Sistema Sencillo 1/2 Ton, 3/4 Ton & Travelall										6802SE <sup>84</sup>	....





### 1300D

69-70	Todos	 	....	82030	....	....	....	 	....	82030	....	....	....
-------	-------	---	------	-------	------	------	------	---	------	-------	------	------	------

#### 1300D ESTABILIZADORES DE DIRECCIÓN

										Delantero	Trasero	
69-70	Estabilizador de Dirección Sistema Sencillo 1/2 Ton, 3/4 Ton & Travelall										6802SE <sup>84</sup>	....





### 1310

71-73	Todos	 	....	82030	....	....	....	 	....	82030	....	....	....
-------	-------	---	------	-------	------	------	------	---	------	-------	------	------	------

#### 1310 ESTABILIZADORES DE DIRECCIÓN

										Delantero	Trasero	
71-73	Estabilizador de Dirección Sistema Sencillo 1/2 Ton, 3/4 Ton & Travelall										6802SE <sup>84</sup>	....





## M SERIES VAN

65-67	Todos	 	....	81318 82007	....	....	....	 	G63405	61500 81147	77405	....	43048 <sup>8</sup> 49310 <sup>7</sup>
-------	-------	---	------	----------------	------	------	------	---	--------	----------------	-------	------	--

#### M800 ESTABILIZADORES DE DIRECCIÓN

										Delantero	Trasero	
68-71	Estabilizador de Dirección Sistema Sencillo 1/2 & 3/4 Ton c/ Eje de Viga en I										6802SE <sup>84</sup>	....

### M1100 / M1200

68-72	Todos	 	....	81318 82007	....	....	....	 	G63405	61500 81147	77405	....	43048 <sup>8</sup> 49310 <sup>7</sup>
-------	-------	---	------	----------------	------	------	------	---	--------	----------------	-------	------	--

#### M1100 / M1200 ESTABILIZADORES DE DIRECCIÓN

										Delantero	Trasero	
68-72	Estabilizador de Dirección Sistema Sencillo 1/2 & 3/4 Ton c/ Eje de Viga en I										6802SE <sup>84</sup>	....

7 Paquetes en pares; kit de mangueras de aire incluido





8 Paquetes en pares

84 Amortiguador de repuesto para los vehículos con el kit de montaje aftermarket

GRC





# AMORTIGUADORES Y STRUTS

Año	Notas de Aplicación										
			Ultra	ProGuard\ Guardian	Max Control\ LTV	Protector de Strut\ Bases de Strut	HiJacker\ Soporte\ Hidráulico		Ultra	ProGuard\ Guardian	Max Control\ LTV

## INTERNATIONAL



### M1400

69	Todos		....	82007	....	....	....		G63405	61500 81147	77405	....	43048 <sup>8</sup> 49310 <sup>7</sup>
----	-------	---	------	-------	------	------	------	---	--------	----------------	-------	------	--

### M1400 ESTABILIZADORES DE DIRECCIÓN

										Delantero	Trasero	
69	Estabilizador de Dirección Sistema Sencillo 1/2 & 3/4 Ton c/ Eje de Viga en I										6802SE <sup>84</sup>	....

### TRAVELALL





75	Todos		....	82030	....	....	....		....	....	....	....	....
----	-------	---	------	-------	------	------	------	---	------	------	------	------	------

### TRAVELALL ESTABILIZADORES DE DIRECCIÓN



										Delantero	Trasero	
75	4WD, Estabilizador de Dirección Sistema Sencillo										6803SE <sup>84</sup>	....
	RWD										6802SE <sup>84</sup>	....

## ISUZU

















### I-280

06	Todos		....	....	....	....	....		G63882	....	....	....	....
	RWD, Exc. Paquete Z71 Off Road		G51850	....	....	....	....		G63882	....	....	....	....

### I-350









06	Barra de Torsion(FrontSpringType)		G63884	....	....	....	....		G63879	....	....	....	....
----	-----------------------------------	---	--------	------	------	------	------	---	--------	------	------	------	------

### PICKUP

82-95	Todos		....	....	....	....	....		....	61506 81318	77492	....	49311
	4WD		G63909	61508 81507	77909	....	....		G63928	61506 81318	77492	....	49311
	RWD		G63902	61501 81478	77902	....	....		G63492	61506 81318	77492	....	49311
	RWD		....	....	....	....	70161		....	61506 81318	77492	....	49311
81	Todos		....	....	....	....	....		....	61506 81318	77492	....	49311 <sup>7</sup>
	4WD		G63909	61508 81507	77909	....	....		G63928	61506 81318	77492	....	49311 <sup>7</sup>
	RWD		G63902	61501 81478	77902	....	....		G63492	61506 81318	77492	....	49311 <sup>7</sup>
	RWD		....	....	....	....	70161		....	61506 81318	77492	....	49311 <sup>7</sup>

## JEEP



### CHEROKEE

84-01	Todos		G63424	61535 81548	77424	....	....		G63425	61536 81549	77425	....	49226 <sup>7</sup>
76-83	Todos		G63377	61519 81484	58377 77377	....	....		G63377	61519 81484	58377 77377	....	43058 <sup>8</sup> 49127 <sup>7</sup>
75	Todos		G63377	61519 81484	58377 77377	....	....		....	....	....	....	43058
74	Todos		G63377	61519 81484	58377 77377	....	....		....	81676	....	....	43058

### CHEROKEE ESTABILIZADORES DE DIRECCIÓN

										Delantero	Trasero	
84-01	Todos										14040	....
84-00	Estabilizador de Dirección Sistema Sencillo; con orificio de montaje de EO en brazo de dirección										6801SE <sup>80</sup>	....
75-83	4WD, Estabilizador de Dirección Sistema Sencillo										6804SE <sup>80</sup>	....
74	Estabilizador de Dirección Sistema Sencillo										6804SE <sup>80</sup>	....

### CJ3

61-66	Exc. 5 Resortes Helicoidales Delanteros y Kit de Levantamiento		....	82007	....	....	....		....	....	....	....	....
-------	--	---	------	-------	------	------	------	---	------	------	------	------	------



7 Paquetes en pares; kit de mangueras de aire incluido

80 No requiere soportes para el montaje, instalar sobre montajes de EO Vea Ref. C para Botas.

8 Paquetes en pares

84 Amortiguador de repuesto para los vehículos con el kit de montaje aftermarket GRC

# AMORTIGUADORES Y STRUTS

Año	Notas de Aplicación										
		Ultra	ProGuard\ Guardian	Max Control\ LTV	Protector de Strut\ Bases de Strut	HiJacker\ Soporte\ Hidráulico	Ultra	ProGuard\ Guardian	Max Control\ LTV	Protector de Strut\ Bases de Strut	HiJacker\ Soporte\ Hidráulico

**JEEP**

**JEEP**

## CJ3 (cont)

65	Exc. Kit de Levantamiento	...	...	...	...	...	○	G63405	...	...	...	...
	Kit de Levantamiento de 2-4"	...	...	...	...	...	○	G63440 <sup>50</sup>	...	...	...	...

## CJ5

82-83	Exc. Kit de Levantamiento	○	G63377	61519 81484	77377	...	...	○	G63405	61500 81147	77405	...	43048 <sup>8</sup> 49310 <sup>7</sup>
	Kit de Levantamiento de 2"	○	...	...	...	...	...	○	G63443 <sup>50</sup>	...	...	...	...
	Kit de Levantamiento de 2-4"	○	G63441	...	...	...	...	○	...	...	...	...	...
	Kit de Levantamiento de 3-4"	○	...	...	...	...	...	○	G63440 <sup>50</sup>	...	...	...	...
72-81	Exc. Kit de Levantamiento	○	G63299	82007	...	...	...	○	G63405	61500 81147	77405	...	43048 <sup>8</sup> 49310 <sup>7</sup>
	Kit de Levantamiento de 2-4"	○	G63443 <sup>50</sup>	...	...	...	...	○	G63440 <sup>50</sup>	...	...	...	...
66-71	Todos	○	...	...	...	...	...	○	...	61500	...	...	43048 <sup>8</sup> 49310 <sup>7</sup>
	Exc. 5 Resortes Helicoidales Delanteros y Kit de Levantamiento	○	...	82007	...	...	...	○	...	81147 61500	...	...	43048 <sup>8</sup> 49310 <sup>7</sup>
	Exc. Kit de Levantamiento	○	...	...	...	...	...	○	G63405	61500	77405	...	43048 <sup>8</sup> 49310 <sup>7</sup>
	Kit de Levantamiento de 2-4"	○	G63443 <sup>50</sup>	...	...	...	...	○	G63440 <sup>50</sup>	61500	...	...	43048 <sup>8</sup> 49310 <sup>7</sup>
	Resorte Frontal de 5 Hojas Exc. Kit de Levantamiento	○	...	81676	...	...	...	○	...	81676 61500	...	...	43048 <sup>8</sup> 49310 <sup>7</sup>
61-65	Exc. 5 Resortes Helicoidales Delanteros y Kit de Levantamiento	○	...	82007	...	...	...	○	...	...	...	...	...
65	Exc. Kit de Levantamiento	○	...	...	...	...	...	○	G63405	...	...	...	...
	Kit de Levantamiento de 2-4"	○	...	...	...	...	...	○	G63440 <sup>50</sup>	...	...	...	...

## CJ5 ESTABILIZADORES DE DIRECCIÓN

		Delantero	Trasero
66-83	Estabilizador de Dirección Sistema Sencillo	6802SE <sup>84</sup>	...
59-60	Estabilizador de Dirección Sistema Sencillo	6802SE <sup>84</sup>	...

## CJ5D

84-86	4.2L 6Cyl (258) 4BBL	○	G63377	81484	...	...	...	○	...	...	...	...
	4.6L 6Cyl (282) 4WD; 2BBL	○	G63377	81484	...	...	...	○	...	...	...	...
82-83	4.6L 6Cyl (282) 4WD; 2BBL	○	G63377	81484	...	...	...	○	...	81147	...	...
73-81	4.6L 6Cyl (282) 4WD; 2BBL	○	G63299	82007	...	...	...	○	...	81147	...	...
75-78	4.2L 6Cyl (258) 4BBL	○	G63299	82007	...	...	...	○	...	81147	...	...
65-71	3.8L 6Cyl (232) RWD; 4BBL	○	G63299	81676	...	...	...	○	...	81147	...	...
	4.2L 6Cyl (258) 4BBL	○	G63299	81676	...	...	...	○	...	81147	...	...

## CJ5S

66-71	4.2L 6Cyl (258) 4WD; 1BBL	○	...	81676	...	...	...	○	...	81147	...	...
71	3.8L 6Cyl (232) RWD; DOHC; MFI	○	...	81676	...	...	...	○	...	81147	...	...
70	3.8L 6Cyl (232) RWD; DOHC; FI	○	...	81676	...	...	...	○	...	...	...	...
	3.8L 6Cyl (232) RWD; DOHC; MFI	○	...	...	...	...	...	○	...	81147	...	...
68-69	3.8L 6Cyl (232) RWD; DOHC; FI	○	...	81676	...	...	...	○	...	81147	...	...
65-67	3.8L 6Cyl (232) RWD; 4BBL	○	...	81676	...	...	...	○	...	81147	...	...
65	4.2L 6Cyl (258) 4BBL	○	...	81676	...	...	...	○	...	81147	...	...

## CJ6

72-75	Exc. Kit de Levantamiento	○	G63299	82007	...	...	...	○	G63405	61500 81147	77405	...	43048 <sup>8</sup> 49310 <sup>7</sup>
-------	---------------------------	---	--------	-------	-----	-----	-----	---	--------	----------------	-------	-----	--





7 Paquetes en pares; kit de mangueras de aire incluido

8 Paquetes en pares

50 Para proteger la barra del pistón, se recomienda utilizar el kit Bellows No.141242.

84 Amortiguador de repuesto para los vehículos con el kit de montaje aftermarket GRC

















# AMORTIGUADORES Y STRUTS

Año	Notas de Aplicación										
			Ultra	ProGuard\ Guardian	Max Control\ LTV	Protector de Strut\ Bases de Strut	HiJacker\ Soporte\ Hidráulico		Ultra	ProGuard\ Guardian	Max Control\ LTV

## JEEP

## JEEP































### CJ6 (cont)

72-75	Kit de Levantamiento de 2-4"		G63443 <sup>50</sup>	....	....	....	....		G63440 <sup>50</sup>	....	....	....	....
66-71	Todos		....	....	....	....	....		....	61500	....	....	43048 <sup>8</sup> 49310 <sup>7</sup>
	Exc. 5 Resortes Helicoidales Delanteros y Kit de Levantamiento		....	82007	....	....	....		....	61500	....	....	43048 <sup>8</sup> 49310 <sup>7</sup>
	Exc. Kit de Levantamiento		....	....	....	....	....		G63405	81147 61500	77405	....	43048 <sup>8</sup> 49310 <sup>7</sup>
	Kit de Levantamiento de 2-4"		G63443 <sup>50</sup>	....	....	....	....		G63440 <sup>50</sup>	61500	....	....	43048 <sup>8</sup> 49310 <sup>7</sup>
65	Resorte Frontal de 5 Hojas Exc. Kit de Levantamiento		....	81676	....	....	....		....	81676 61500	....	....	43048 <sup>8</sup> 49310 <sup>7</sup>
	Exc. Kit de Levantamiento		....	....	....	....	....		G63405	....	....	....	....
	Kit de Levantamiento de 2-4"		....	....	....	....	....		G63440 <sup>50</sup>	....	....	....	....

### CJ6 ESTABILIZADORES DE DIRECCIÓN

		Delantero	Trasero
66-75	Estabilizador de Dirección Sistema Sencillo	6802SE <sup>84</sup>	....
59-60	Estabilizador de Dirección Sistema Sencillo	6802SE <sup>84</sup>	....



### CJ7

82-86	Todos		....	81484	....	....	....		....	....	....	....	
	Exc. Kit de Levantamiento		G63377	61519 81484	77377	....	....		G63405	61500 81147	77405	....	43048 <sup>8</sup> 49310 <sup>7</sup>
	Kit de Levantamiento de 2"		....	81484	....	....	....		G63443 <sup>50</sup>	....	....	....	....
	Kit de Levantamiento de 2-4"		G63441 <sup>50</sup>	81484	....	....	....		....	....	....	....	....
	Kit de Levantamiento de 3-4"		....	81484	....	....	....		G63440 <sup>50</sup>	....	....	....	....
	4.6L 6Cyl (282) 4WD; 2BBL		....	81484	....	....	....		....	....	....	....	....
76-81	Exc. Kit de Levantamiento		G63299	82007	....	....	....		G63405	61500 81147	77405	....	43048 <sup>8</sup> 49310 <sup>7</sup>
	Kit de Levantamiento de 2-4"		G63443 <sup>50</sup>	....	....	....	....		G63440 <sup>50</sup>	....	....	....	....
69-75	3.8L 6Cyl (232) RWD; FI		....	....	....	....	42973		G63928	81147	....	....	....
68-75	4.2L 6Cyl (258) 4WD; 2BBL		....	....	....	....	42973		G63928	81147	....	....	....
	Excluye kit de levante		....	....	....	....	....		....	61500	....	....	....
68	3.8L 6Cyl (232) RWD; DOHC; MFI		....	....	....	....	42973		G63928	....	....	....	....
	3.8L 6Cyl (232) RWD; FI		....	....	....	....	....		....	81147	....	....	....
65-67	3.8L 6Cyl (232) RWD; DOHC; MFI		....	....	....	....	....		....	81147	....	....	....
	4.2L 6Cyl (258) 4WD; 2BBL		....	....	....	....	....		....	81147	....	....	....

### CJ7 ESTABILIZADORES DE DIRECCIÓN

		Delantero	Trasero
76-86	Estabilizador de Dirección Sistema Sencillo	6802SE <sup>84</sup>	....



### COMANCHE

86-92	Todos		G63424	61535 81548	77424	....	....		G63492	61506 81318	77492	....	....
-------	-------	---	--------	----------------	-------	------	------	---	--------	----------------	-------	------	------

### COMANCHE ESTABILIZADORES DE DIRECCIÓN

		Delantero	Trasero
86-92	Todos	14040	....
	Estabilizador de Dirección Sistema Sencillo; con orificio de montaje de EO en brazo de dirección	6801SE <sup>80</sup>	....

### COMMANDER

06-10	Todos		G56807	....	....	143364 <sup>3</sup>	....		G64012	61715	....	....	....
-------	-------	---	--------	------	------	---------------------	------	---	--------	-------	------	------	------

3 Número de parte futuro

8 Paquetes en pares



80 No requiere soportes para el montaje, instalar sobre montajes de EO Vea Ref. C para Botas.

7 Paquetes en pares; kit de mangueras de aire incluido

50 Para proteger la barra del pistón, se recomienda utilizar el kit Bellows No.141242.

84 Amortiguador de repuesto para los vehículos con el kit de montaje aftermarket GRC

# AMORTIGUADORES Y STRUTS

Año	Notas de Aplicación										
		Ultra	ProGuard\ Guardian	Max Control\ LTV	Protector de Strut\ Bases de Strut	HiJacker\ Soporte\ Hidráulico	Ultra	ProGuard\ Guardian	Max Control\ LTV	Protector de Strut\ Bases de Strut	HiJacker\ Soporte\ Hidráulico

## JEEP

## JEEP

### DISPATCHER

61-67	Todos	<input type="radio"/>	.....	81676	.....	.....	.....	<input type="radio"/>	.....	81676	.....	.....	.....
-------	-------	-----------------------	-------	-------	-------	-------	-------	-----------------------	-------	-------	-------	-------	-------

### DJ5

66-74	Exc. Kit de Levantamiento	<input type="radio"/>	G63299	82007	.....	.....	.....	<input type="radio"/>	G63405	61500 81147	77405	.....	43048 <sup>8</sup> 49310 <sup>7</sup>
	Kit de Levantamiento de 2-4"	<input type="radio"/>	G63443 <sup>50</sup>	.....	.....	.....	.....	<input type="radio"/>	G63440 <sup>50</sup>	.....	.....	.....	.....

### DJ6

66-68	Todos	<input type="radio"/>	.....	82007	.....	.....	.....	<input type="radio"/>	.....	61500 81147	.....	.....	43048 <sup>8</sup> 49310 <sup>7</sup>
	Exc. Kit de Levantamiento	<input type="radio"/>	.....	82007	.....	.....	.....	<input type="radio"/>	G63405	61500 81147	77405	.....	43048 <sup>8</sup> 49310 <sup>7</sup>
	Kit de Levantamiento de 2-4"	<input type="radio"/>	G63443 <sup>50</sup>	82007	.....	.....	.....	<input type="radio"/>	G63440 <sup>50</sup>	61500 81147	.....	.....	43048 <sup>8</sup> 49310 <sup>7</sup>

### FC150

61-65	Todos	<input type="radio"/>	.....	82007	.....	.....	.....	<input type="radio"/>	.....	81676	.....	.....	.....
57-60	Todos	<input type="radio"/>	.....	82007	.....	.....	.....	<input type="radio"/>	G63405	61500 81147	77405	.....	43048 <sup>8</sup> 49310 <sup>7</sup>

### FC170

63-65	Todos	<input type="radio"/>	G63405	61500 81147	77405	.....	.....	<input type="radio"/>	G63405	61500 81147	77405	.....	43048 <sup>8</sup> 49310 <sup>7</sup>
-------	-------	-----------------------	--------	----------------	-------	-------	-------	-----------------------	--------	----------------	-------	-------	--

### GLADIATOR

67	Todos	<input type="radio"/>	.....	81318	.....	.....	.....	<input type="radio"/>	.....	61519 81484	.....	.....	43058 <sup>8</sup> 49127 <sup>7</sup>
66	Todos	<input type="radio"/>	.....	81318	.....	.....	.....	<input type="radio"/>	.....	81147	.....	.....	49310 <sup>7</sup>
	Suspensión Delantera Independiente	<input type="radio"/>	.....	81318	.....	.....	.....	<input type="radio"/>	G63405	61500 81147	77405	.....	43048 <sup>8</sup> 49310 <sup>7</sup>
64-65	Todos	<input type="radio"/>	.....	.....	.....	.....	.....	<input type="radio"/>	.....	81147	.....	.....	49310 <sup>7</sup>
	Exc. Suspensión Independiente Delantera	<input type="radio"/>	.....	81318	.....	.....	.....	<input type="radio"/>	.....	81147	.....	.....	49310 <sup>7</sup>
63-65	Suspensión Delantera Independiente	<input type="radio"/>	.....	.....	.....	.....	.....	<input type="radio"/>	G63405	61500 81147	77405	.....	43048 <sup>8</sup> 49310 <sup>7</sup>

### GLADIATOR ESTABILIZADORES DE DIRECCIÓN

										Delantero	Trasero
63-67	Estabilizador de Dirección Sistema Sencillo									6803SE <sup>84</sup>	.....

### GRAND CHEROKEE

05-10	Todos	<input type="radio"/>	G56807	.....	.....	143364 <sup>3</sup>	.....	<input type="radio"/>	G64012	61715	.....	.....	.....
99-04	Todos	<input type="radio"/>	.....	81869	.....	.....	.....	<input type="radio"/>	G63829	61676 81926	77829	.....	.....
	Exc. Suspensión Up Country	<input type="radio"/>	G63847	61664 81869	77847	.....	.....	<input type="radio"/>	G63829	61676 81926	77829	.....	.....
95-98	Todos	<input type="radio"/>	G63424	61535 81548	77424	.....	.....	<input type="radio"/>	G63683	61575 81891	77683	.....	.....
93-94	Todos	<input type="radio"/>	G63424	61535 81548	77424	.....	.....	<input type="radio"/>	G63626	61575 81891	77683	.....	.....
92	4L 6Cyl (242) RWD; TBI	<input type="radio"/>	G63424	81548	.....	.....	.....	<input type="radio"/>	.....	.....	.....	.....	.....
	5.2L 8Cyl (318) MFI	<input type="radio"/>	G63424	81548	.....	.....	.....	<input type="radio"/>	.....	.....	.....	.....	.....

### GRAND CHEROKEE ESTABILIZADORES DE DIRECCIÓN

										Delantero	Trasero
99-04	Amortiguador de Dirección Sistema Sencillo									14071	.....
93-98	Todos									6853SE <sup>82</sup>	.....

### GRAND WAGONEER

84-91	Todos	<input type="radio"/>	.....	.....	.....	.....	.....	<input type="radio"/>	.....	.....	.....	.....	70172
-------	-------	-----------------------	-------	-------	-------	-------	-------	-----------------------	-------	-------	-------	-------	-------

3 Número de parte futuro

8 Paquetes en pares





82 Use kit si está señalado. Vea Ref. C para Botas.

7 Paquetes en pares; kit de mangueras de aire incluido

50 Para proteger la barra del pistón, se recomienda utilizar el kit Bellows No.141242.

84 Amortiguador de repuesto para los vehículos con el kit de montaje aftermarket GRC



# AMORTIGUADORES Y STRUTS

Año	Notas de Aplicación										
			Ultra	ProGuard\ Guardian	Max Control\ LTV	Protector de Strut\ Bases de Strut	HiJacker\ Soporte\ Hidráulico		Ultra	ProGuard\ Guardian	Max Control\ LTV

## JEEP

## JEEP



### GRAND WAGONEER (cont)

84-91	Todos		G63377	61519 81484	58377 77377	....	....		G63377	61519 81484	58377 77377	....	....	43058 <sup>8</sup> 49127 <sup>7</sup> 70172
-------	-------	---	--------	----------------	----------------	------	------	---	--------	----------------	----------------	------	------	---

### GRAND WAGONEER ESTABILIZADORES DE DIRECCIÓN

												Delantero	Trasero
84-91	Estabilizador de Dirección Sistema Sencillo											6804SE <sup>80</sup>	....





### J10 PICKUP

74-88	Todos		G63377	61519 81484	77377	....	....		G63377	61519 81484	77377	....	....	43058 <sup>8</sup> 49127 <sup>7</sup>
-------	-------	---	--------	----------------	-------	------	------	---	--------	----------------	-------	------	------	--

### J10 PICKUP ESTABILIZADORES DE DIRECCIÓN

												Delantero	Trasero
74-88	Estabilizador de Dirección Sistema Sencillo											6804SE <sup>80</sup>	....



### J20 PICKUP

74-88	Todos		....	....	....	....	....		....	....	....	....	....	70172
	Todos		G63377	61519 81484	77377	....	....		G63377	61519 81484	77377	....	....	43058 <sup>8</sup> 49127 <sup>7</sup> 70172





### J20 PICKUP ESTABILIZADORES DE DIRECCIÓN

												Delantero	Trasero
74-88	Estabilizador de Dirección Sistema Sencillo											6804SE <sup>80</sup>	....

### J2500 PICKUP

68-73	Todos		....	81318	....	....	....		....	61519 81484	....	....	....	43058 <sup>8</sup> 49127 <sup>7</sup>
-------	-------	--	------	-------	------	------	------	--	------	----------------	------	------	------	--







### JEEPSTER

70-73	Todos		....	82007	....	....	....		G63405	61500 81147	77405	....	....	43048 <sup>8</sup> 49310 <sup>7</sup>
67-69	Todos		....	82007	....	....	....		....	82007	....	....	....	....



### JEEPSTER ESTABILIZADORES DE DIRECCIÓN

												Delantero	Trasero
66-73	Estabilizador de Dirección Sistema Sencillo											6802SE <sup>84</sup>	....





### LIBERTY

12	Todos		G51728	....	....	....	....		G63844	....	....	....	....	....
02-11	Izquierdo		G51728	....	....	143255 <sup>53</sup>	....		G63844	....	....	....	....	....
	Derecho		G51728	....	....	143266 <sup>53</sup>	....		G63844	....	....	....	....	....

### PICKUP

84-91	S364		....	....	....	....	....		....	....	....	....	....	70172
-------	------	---	------	------	------	------	------	---	------	------	------	------	------	-------







### SCRAMBLER / CJ8

82-85	Todos		G63377	61519 81484	77377	....	....		G63405	61500 81147	77405	....	....	43048 <sup>8</sup> 49310 <sup>7</sup>
81	Todos		G63299	82007	....	....	....		G63405	61500 81147	77405	....	....	43048 <sup>8</sup> 49310 <sup>7</sup>

### SCRAMBLER / CJ8 ESTABILIZADORES DE DIRECCIÓN

												Delantero	Trasero
81-85	Estabilizador de Dirección Sistema Sencillo											6802SE <sup>84</sup>	....

### UNIVERSAL

67	Todos		....	82007	....	....	....		....	61500	....	....	....	43048 <sup>8</sup> 49310 <sup>7</sup>
	Exc. C-J-3B		....	82007	....	....	....		....	81147 61500	....	....	....	43048 <sup>8</sup> 49310 <sup>7</sup>
	Exc. Kit de Levantamiento		....	82007	....	....	....		G63405	61500	77405	....	....	43048 <sup>8</sup> 49310 <sup>7</sup>

7 Paquetes en pares; kit de mangueras de aire incluido



53 Montaje de Strut. Es probable reutilizar algunas partes del E.O.

84 Amortiguador de repuesto para los vehículos con el kit de montaje aftermarket GRC

8 Paquetes en pares

80 No requiere soportes para el montaje, instalar sobre montajes de EO Vea Ref. C para Botas.

# AMORTIGUADORES Y STRUTS

Año	Notas de Aplicación										
		Ultra	ProGuard\ Guardian	Max Control\ LTV	Protector de Strut\ Bases de Strut	HiJacker\ Soporte\ Hidráulico	Ultra	ProGuard\ Guardian	Max Control\ LTV	Protector de Strut\ Bases de Strut	HiJacker\ Soporte\ Hidráulico

## JEEP

## JEEP

### UNIVERSAL (cont)

67	Kit de Levantamiento de 2-4"	⊗	G63443 <sup>50</sup>	82007	....	....	....	⊗	G63440 <sup>50</sup>	61500	....	....	43048 <sup>8</sup> 49310 <sup>7</sup>
	Resorte Frontal de 5 Hojas Exc. Kit de Levantamiento	⊗	....	81676 82007	....	....	....	⊗	....	81676 61500	....	....	43048 <sup>8</sup> 49310 <sup>7</sup>
66	Todos	⊗	....	82007	....	....	....	⊗	....	61500	....	....	49310 <sup>7</sup>
	Exc. CJ-3B	⊗	....	82007	....	....	....	⊗	....	81147 61500	....	....	49310 <sup>7</sup>
	Exc. Kit de Levantamiento	⊗	....	82007	....	....	....	⊗	G63405	61500	77405	....	49310 <sup>7</sup>
	Kit de Levantamiento de 2-4"	⊗	G63443 <sup>50</sup>	82007	....	....	....	⊗	G63440 <sup>50</sup>	61500	....	....	49310 <sup>7</sup>
	Resorte Frontal de 5 Hojas Exc. Kit de Levantamiento	⊗	....	81676 82007	....	....	....	⊗	....	81676 61500	....	....	49310 <sup>7</sup>
65	Todos	⊗	....	82007	....	....	....	⊗	....	61500	77405	....	43048 <sup>8</sup> 49310 <sup>7</sup>
	Exc. CJ-3B	⊗	....	82007	....	....	....	⊗	....	81147 61500	77405	....	43048 <sup>8</sup> 49310 <sup>7</sup>
	Exc. Kit de Levantamiento	⊗	....	82007	....	....	....	⊗	G63405	61500	77405	....	43048 <sup>8</sup> 49310 <sup>7</sup>
	Kit de Levantamiento de 2-4"	⊗	G63443 <sup>50</sup>	82007	....	....	....	⊗	G63440 <sup>50</sup>	61500	77405	....	43048 <sup>8</sup> 49310 <sup>7</sup>
	Resorte Frontal de 5 Hojas Exc. Kit de Levantamiento	⊗	....	81676 82007	....	....	....	⊗	....	81676 61500	77405	....	43048 <sup>8</sup> 49310 <sup>7</sup>
61-64	Todos	⊗	....	82007	....	....	....	⊗	G63405	61500	77405	....	43048 <sup>8</sup> 49310 <sup>7</sup>
	Exc. CJ-3B	⊗	....	82007	....	....	....	⊗	G63405	81147 61500	77405	....	43048 <sup>8</sup> 49310 <sup>7</sup>
	Resorte Frontal de 5 Hojas Exc. Kit de Levantamiento	⊗	....	81676 82007	....	....	....	⊗	G63405	81676 61500	77405	....	43048 <sup>8</sup> 49310 <sup>7</sup>

### UNIVERSAL ESTABILIZADORES DE DIRECCIÓN

		Delantero	Trasero
61-67	Estabilizador de Dirección Sistema Sencillo	6802SE <sup>84</sup>	....

### WAGONEER

87-90	Todos	⊗	G63424	61535 81548	77424	....	....	⊗	G63425	61536 81549	77425	....	49226 <sup>7</sup>
84-86	Todos	⊗	G63424	61535 81548	77424	....	42973	⊗	G63425	61536 81549	77425	....	49226 <sup>7</sup>
76-86	Todos	⊗	....	....	....	....	42973	⊗	....	....	....	....	....
76-83	Todos	⊗	G63377	61519 81484	58377 77377	....	42973	⊗	G63377	61519 81484	58377 77377	....	43058 <sup>8</sup> 49127 <sup>7</sup>
75	Todos	⊗	G63377	61519 81484	58377 77377	....	....	⊗	....	....	....	....	43058
74	Todos	⊗	G63377	61519 81484	58377 77377	....	....	⊗	G63299	81676	....	....	43058
71-73	Todos	⊗	G63492	81318	77492	....	....	⊗	G63299	81676	....	....	....
68-70	Todos	⊗	G63492	81318	77492	....	....	⊗	....	81676	....	....	....
66-67	Todos	⊗	G63492	81318	77492	....	....	⊗	G63299	81676	....	....	....
63-65	Todos	⊗	....	....	....	....	....	⊗	G63299	81676	....	....	....
	Exc. Suspensión Independiente Delantera	⊗	G63492	81318	77492	....	....	⊗	G63299	81676	....	....	....
	Suspensión Delantera Independiente	⊗	....	81676	....	....	....	⊗	G63299	81676	....	....	....

### WAGONEER ESTABILIZADORES DE DIRECCIÓN

		Delantero	Trasero
63-67	Exc. Suspensión Independiente Delantera	6802SE <sup>84</sup>	....

### WRANGLER





14	Unlimited Sahara, 4WD	⊗	....	....	....	....	....	⊗	....	....	77973	....	....
13	Todos	⊗	G64008	....	....	....	....	⊗	G63966	....	....	....	....
	Unlimited Sahara, 4WD	⊗	G64008	....	....	....	....	⊗	G63966	....	77973	....	....

7 Paquetes en pares; kit de mangueras de aire incluido

8 Paquetes en pares

50 Para proteger la barra del pistón, se recomienda utilizar el kit Bellows No.141242. 84 Amortiguador de repuesto para los vehículos con el kit de montaje aftermarket GRC









# AMORTIGUADORES Y STRUTS

Año	Notas de Aplicación										
			Ultra	ProGuard\ Guardian	Max Control\ LTV	Protector de Strut\ Bases de Strut	HiJacker\ Soporte\ Hidráulico		Ultra	ProGuard\ Guardian	Max Control\ LTV

## JEEP

## JEEP

### WRANGLER (cont)

07-12	Todos		G64008	61711	77972	....	....	....	....	....	....	....
	Exc. Ruedas de 17"		G64008	61711	77972	....	....	G63966	61696	....	....	....
	Ruedas de 17"		G64008	61711	77972	....	....	G63967	61697	....	....	....
12	Unlimited Sahara, 4WD		G64008	61711	77972	....	....	....	....	77973	....	....
07-11	Unlimited Sahara, Unlimited X, 4WD		G64008	61711	77972	....	....	....	....	77973	....	....
	X		G64008	61711	77972	....	....	....	....	77973	....	....
97-06	TJ(Código plataforma del fabricante)		G63721	61615 81936	....	....	....	G63722	61616 81929	....	....	....
87-95	YJ(Código plataforma del fabricante)		G63511	61551 <sup>6</sup> 81691	....	....	....	G63490	61541 81583	....	....	49222 <sup>7</sup>













### WRANGLER ESTABILIZADORES DE DIRECCIÓN

		Delantero	Trasero
97-06	TJ(Código plataforma del fabricante) Estabilizador de Dirección Sistema Sencillo; con orificio de montaje de EO en brazo de dirección	6801SE <sup>80</sup>	....
94-95	YJ(Código plataforma del fabricante) Estabilizador de Dirección Sistema Sencillo; con orificio de montaje de EO en brazo de dirección	6801SE <sup>80</sup>	....
87-92	YJ(Código plataforma del fabricante) Estabilizador de Dirección Sistema Sencillo; con orificio de montaje de EO en brazo de dirección	6801SE <sup>80</sup>	....























## LINCOLN

## LINCOLN

### MARK LT

09-12	Todos		....	....	....	....	....		G64079	....	....	....	....
	AWD		G51864	....	....	....	....		G64079	....	....	....	....
	RWD		G51865	....	....	....	....		G64079	....	....	....	....
06-08	Todos		....	....	....	143248 <sup>53</sup>	....		....	....	....	....	....
	4WD		G51704	....	....	143248 <sup>53</sup>	....		G63867	....	....	....	....
	RWD		G51703	....	....	143248 <sup>53</sup>	....		G63870	....	....	....	....

### NAVIGATOR

10-12	Todos		G51860	....	....	143424 <sup>53</sup>	....		G51861	....	....	....	....
	RWD		G51860	....	....	143424 <sup>53</sup>	....		G51861	....	....	143393	....
09	Todos		G51860	....	....	143376 143424 <sup>53</sup>	....		G51861	....	....	....	....
	RWD		G51860	....	....	143376 143424 <sup>53</sup>	....		G51861	....	....	143393	....
07-08	Todos		G51860	....	....	143376	....		G51861	....	....	....	....
	RWD		G51860	....	....	143376	....		G51861	....	....	143393	....
03-05	Todos		....	....	....	143244 <sup>53</sup>	....		G51729	....	....	....	....
98-02	4WD, Air(RearSpringType)		....	....	....	....	....		G64002	61703	....	....	....
	Coil(FrontSpringType)		....	61611	....	....	....		....	....	....	....	....
	RWD		G63714	81912	58714 77714	....	....		G63717	61614	77717	....	....
	RWD, Coil(FrontSpringType)		....	....	....	....	....		....	....	58717	....	....

6 Se recomienda que cuando se reemplacen amortiguadores "quad", los 4 sean de la misma serie.





53 Montaje de Strut. Es probable reutilizar algunas partes del E.O.

Texto en Negritas - Número de Parte Nuevo / Futuro

7 Paquetes en pares; kit de mangueras de aire incluido

80 No requiere soportes para el montaje, instalar sobre montajes de EO Vea Ref. C para Botas.



# AMORTIGUADORES Y STRUTS

Año	Notas de Aplicación										
		 Ultra	ProGuard\ Guardian	Max Control\ LTV	Protector de Strut\ Bases de Strut	HiJacker\ Soporte\ Hidráulico	 Ultra	ProGuard\ Guardian	Max Control\ LTV	Protector de Strut\ Bases de Strut	HiJacker\ Soporte\ Hidráulico



## MAZDA

## MAZDA







### B1600

72-76	Todos		G63421	61504 81750	58421 77421	....	....		....	61502 82125	....	....	....
-------	-------	---	--------	----------------	----------------	------	------	---	------	----------------	------	------	------







### B1800

77-78	Todos		G63421	61504 81750	58421 77421	....	....		....	61502 82125	....	....	....
-------	-------	---	--------	----------------	----------------	------	------	---	------	----------------	------	------	------









### B2000

86-87	RWD		G63495	61593 81553	....	....	....		G63907	61500 81147	77907	....	43048 <sup>8</sup> 49310 <sup>7</sup>
	RWD		....	....	....	....	....		....	....	....	....	70163
79-84	Todos		G63421	61504 81750	58421 77421	....	....		....	61502 82125	....	....	....





### B2200

87-93	RWD		G63495	61593 81553	....	....	....		G63907	61500 81147	77907	....	43048 <sup>8</sup> 49310 <sup>7</sup>
	RWD		....	....	....	....	....		....	....	....	....	70163
82-84	Todos		G63421	61504 81750	58421 77421	....	....		....	61502 82125	....	....	....







### B2300

01-06	RWD		G63772	61626 81916	77772	....	....		G63773	61627	77525	....	....
94-97	Todos		G63614	61561 81744	58929 77614	....	....		....	....	....	....	....
	RWD		G63614	61561 81744	58929 77614	....	....		G63525	61559 81730	77525	....	49223 <sup>7</sup>
95-96	4WD		G63614	61561 81744	58929 77614	....	....		G63524	61573 81905	77524	....	....























### B2500

98-01	Todos		....	....	....	....	....		....	81917	....	....	....
	RWD		G63772	61626 81916	77772	....	....		G63773	61627 81917	77525	....	....

### B2600

87-93	4WD		G63635	61596	....	....	....		G63639	61597 81907	....	....	....
	RWD		G63495	61593 81553	....	....	....		G63907	61500 81147	77907	....	43048 <sup>8</sup> 49310 <sup>7</sup>
	RWD		....	....	....	....	....		....	....	....	....	70163

### B3000





98-08	Todos		....	....	....	....	....		....	....	....	....	43185
98-06	4WD		G63678	61623 81893	77678	....	....		G63775	61629 81918	77524	....	43185
	RWD		G63772	61626 81916	77772	....	....		G63773	61627 81917	77525	....	43185
94-97	Todos		G63614	61561	....	....	....		....	....	....	....	43185
	4WD		G63614	61561	....	....	....		G63524	81905	....	....	43185
97	RWD		G63614	61561	77614	....	....		G63525	61559	77525	....	43185
96	4WD, RWD		G63614	81744 61561	....	....	....		....	....	....	....	43185
	RWD		G63614	61561	77614	....	....		G63525	61559 81730	77525	....	43185
95	RWD		G63614	81744 61561	77614	....	....		G63525	61559	77525	....	43185
94	4WD, RWD		G63614	81744 61561	....	....	....		....	....	....	....	43185
	RWD		G63614	61561	77614	....	....		G63525	61559 81730	77525	....	43185

7 Paquetes en pares; kit de mangueras de aire incluido

8 Paquetes en pares





















# AMORTIGUADORES Y STRUTS

Año	Notas de Aplicación										
			Ultra	ProGuard\ Guardian	Max Control\ LTV	Protector de Strut\ Bases de Strut	HiJacker\ Soporte\ Hidráulico		Ultra	ProGuard\ Guardian	Max Control\ LTV

## MAZDA

## MAZDA











### B4000

98-08	Todos		....	....	....	....	....		....	....	....	....	43185
05-06	4WD		G63678	61623 81893	77678	....	....		G63775	61629	77524	....	43185
	RWD		G63772	61626	77772	....	....		G63773	61627	77525	....	43185
98-04	4WD		G63678	61623 81893	77678	....	....		G63775	61629 81918	77524	....	43185
	RWD		G63772	61626 81916	77772	....	....		G63773	61627 81917	77525	....	43185
95-97	RWD		G63614	61561 81744	77614	....	....		G63525	....	77525	....	43185
94-97	Todos		G63614	81744	....	....	....		....	....	....	....	43185
	4WD		G63614	81744	....	....	....		G63524	81905	....	....	43185
94	RWD		G63614	61561 81744	77614	....	....		G63525	61559	77525	....	43185



## MERCEDES-BENZ

## MERCEDES-BENZ







### E300

99	Exc. 4 Matic		....	....	....	....	....		69966	....	....	....	....
	Exc. Suspensión Deportiva		69952	....	....	....	....		....	....	....	....	....
96-98	Todos		....	....	....	....	....		69966	....	....	....	....
	Exc. Suspensión Deportiva		69952	....	....	....	....		69966	....	....	....	....
95	Todos		G55527	....	....	142326 <sup>53</sup>	....		69807	....	....	....	....





### E500

94	Todos		G55527	....	....	142326 <sup>53</sup>	....		69807	....	....	....	....
----	-------	---	--------	------	------	----------------------	------	---	-------	------	------	------	------





### SPRINTER

04-06	Todos		G56778	....	....	....	....		....	....	....	....	....
	Doble Rodada Trasera		G56778	....	....	....	....		G63919	....	....	....	....
	Exc. Doble Rodada Trasera		G56778	....	....	....	....		G63918	....	....	....	....

### SPRINTER 315



07-12	Cargo Van & Chassis Cab Exc. LWB		....	....	....	....	....		G64091	....	....	....	....
07-10	Cargo Van & Chassis Cab		G52343	....	....	....	....		....	....	....	....	....

### SPRINTER 415 & 515

11-12	Todos		....	....	....	....	....		G64089	....	....	....	....
07-10	Todos		G52341	....	....	....	....		G64089	....	....	....	....







53 Montaje de Strut. Es probable reutilizar algunas partes del E.O.

# AMORTIGUADORES Y STRUTS





Año	Notas de Aplicación										
		Ultra	ProGuard\ Guardian	Max Control\ LTV	Protector de Strut\ Bases de Strut	HiJacker\ Soporte\ Hidráulico	Ultra	ProGuard\ Guardian	Max Control\ LTV	Protector de Strut\ Bases de Strut	HiJacker\ Soporte\ Hidráulico

## MITSUBISHI RAIDER

## MITSUBISHI

06-09	Todos		G51815	....	....	143385 <sup>53</sup>	....		....	....	....	....	....
	4WD		G51815	....	....	143385 <sup>53</sup>	....		G63891	....	....	....	....
	RWD		G51815	....	....	143385 <sup>53</sup>	....		G63890	....	....	....	....



## VAN

87-90	Todos		....	....	....	....	....		....	....	....	....	70163
	Todos		G63904	61593 81872	77904	....	....		G63907	61500 81147	77907	....	43048 <sup>8</sup> 49310 <sup>7</sup> 70163



















## NISSAN

## NISSAN

## F10

79-81	Sedan		....	....	....	....	....		69881	....	....	....	....
-------	-------	---	------	------	------	------	------	---	-------	------	------	------	------























## FRONTIER

13	Exc. Nismo Off-Road		....	....	....	....	....		G64031	....	....	....	....
	Fab. hasta 12/12; Exc. Nismo Off-Road		G51766	....	....	....	....		....	....	....	....	....
05-12	Todos		....	....	....	143379	....		....	....	....	....	....
	Exc. Nismo Off-Road		....	....	....	143379	....		G64031	....	....	....	....
	Fab. hasta 12/12; Exc. Nismo Off-Road		G51766	....	....	143379	....		....	....	....	....	....
12	Fab. hasta 12/12; Exc. Nismo Off Road		G51766	....	....	143379	....		....	....	....	....	....
98-04	4WD		G63813	61662	....	....	....		G63492	61506 81318	77492	....	49311 <sup>7</sup>
	RWD, Exc. Desert Runner		G63909	61508 81507	77909	....	....		G63907	61500 81147	77907	....	43048 <sup>8</sup> 49310 <sup>7</sup> 70163
	RWD; Crew Cab con Desert Runner		G63813	61662	....	....	....		G63492	61506 81318	77492	....	49311 <sup>7</sup>

## FRONTIER ESTABILIZADORES DE DIRECCIÓN

							Delantero	Trasero
98	4WD						6863SE <sup>82</sup>	....

## PICKUP





05-12	Todos		G63902	61501	....	....	70161		....	61500	....	....	70163
	4WD		G63902	81478 61501	77902	....	70161		....	61500	....	....	70163
12	RWD		G63902	61501	....	....	70161		G63907	81147 61500	77907	....	70163
05-11	RWD		G63902	61501	....	....	70161		G63907	61500 81147	77907	....	70163
05-08	2.4L 4Cyl (146) RWD; 1BBL		G63902	61501	....	....	70161		....	61500	....	....	42973 70163
98-04	Todos		G63902	61501	....	....	70161		....	....	....	....	70163
	RWD		G63902	61501	....	....	70161		G63907	61500 81147	77907	....	42973 70163
	RWD 2.4L 4Cyl L		G63902	61501	....	....	42972 70161		....	....	....	....	70163
04	4WD		G63902	81478 61501	77902	....	70161		....	....	....	....	70163
98-03	4WD		G63902	61501	77902	....	70161		....	....	....	....	70163
95-97	Todos		....	....	....	....	70161		....	....	....	....	70163

7 Paquetes en pares; kit de mangueras de aire incluido  
53 Montaje de Strut. Es probable reutilizar algunas partes del E.O.

8 Paquetes en pares  
82 Use kit si está señalado. Vea Ref. C para Botas.

Texto en Negritas - Número de Parte Nuevo / Futuro

# AMORTIGUADORES Y STRUTS

Año	Notas de Aplicación										
			Ultra	ProGuard\ Guardian	Max Control\ LTV	Protector de Strut\ Bases de Strut	HiJacker\ Soporte\ Hidráulico		Ultra	ProGuard\ Guardian	Max Control\ LTV

## NISSAN

## NISSAN

### PICKUP (cont)

95-97	4WD		G63902	61501 81478	77902	....	70161		G63492	61506 81318	77492	....	49311 <sup>7</sup> 70163	
	D21 4WD		G63902	....	....	....	70161		....	....	....	....	70163	
	RWD		G63909	61508 81507	77909	....	....	70161		G63907	61500 81147	77907	....	42973 43048 <sup>8</sup> 49310 <sup>7</sup> 70163
	RWD 2.4L 4Cyl L		....	....	....	....	....	42972 70161		....	....	....	....	70163
94	Todos		G63902	....	77902	....	70161		....	....	77907	....	42973 70163	
	1.8L 4Cyl (110) 2BBL		G63902	....	77902	....	42972 70161		....	....	77907	....	42973 70163	
	4WD		G63902	81478	77902	....	....	70161		....	....	77907	....	42973 70163
	D21 4WD		G63902	....	77902	....	....	70161		....	....	77907	....	42973 70163
	RWD		G63902	....	77902	....	....	70161		G63907	61500 81147	77907	....	42973 70163
91-93	2.4L 4Cyl (146) RWD; 1BBL		....	....	....	....	42972 70161		....	....	....	....	42973 70163	
84-93	Todos		....	....	....	....	70161		....	....	....	....	42973 70163	
	1.8L 4Cyl (110) 2BBL		....	....	....	....	42972 70161		....	....	....	....	42973 70163	
	2WD 1.8L 4Cyl (110) 2BBL		....	....	....	....	....	70161		....	....	....	42970 42973 70163	
	D21 4WD		G63902	61501 81478	77902	....	....	70161		G63492	61506 81318	77492	....	49311 42973 70163
	D21 RWD		G63909	61508 81507	77909	....	....	70161		G63907	61500 81147	77907	....	49310 42973 70163
93	2WD 2.4L 4Cyl (146) RWD; 1BBL		....	....	....	....	70161		....	....	....	....	42970 42973 70163	
91-92	2WD 2.4L 4Cyl (146) 1BBL		....	....	....	....	70161		....	....	....	....	42970 42973 70163	
81-83	1.8L 4Cyl (110) 2BBL		....	....	....	....	42972 70161		G63491	....	....	....	....	
	2WD 1.8L 4Cyl (110) 2BBL		....	....	....	....	70161		....	....	....	....	42970	
70-83	1.6L 4Cyl (98) 1BBL		....	....	....	....	42972 70161		G63491	....	....	....	....	
	2WD 1.6L 4Cyl (98) 1BBL		....	....	....	....	70161		....	....	....	....	42970	
65-83	Todos		....	....	....	....	70161		....	....	....	....	....	
	D21 4WD		G63902	61501 81478	77902	....	....	70161		G63492	61506 81318	77492	....	49311
	D21 RWD		G63909	61508 81507	77909	....	....	70161		G63907	61500 81147	77907	....	49310
65-69	1.3L 4Cyl (79) 1BBL		....	....	....	....	42972 70161		G63491	....	....	....	....	
	2WD 1.3L 4Cyl (79) 1BBL		....	....	....	....	70161		....	....	....	....	42970	

### PICKUP ESTABILIZADORES DE DIRECCIÓN

		Delantero		Trasero	
95-97	4WD	6848SE <sup>82</sup>		....	
84-97	4WD; Estabilizador de direccion	6848SE		....	



### TITAN

12-13	Todos		G51715	....	....	....	....	....	....	....	....	....
-------	-------	---	--------	------	------	------	------	------	------	------	------	------

7 Paquetes en pares; kit de mangueras de aire incluido  
82 Use kit si está señalado. Vea Ref. C para Botas.

8 Paquetes en pares







# AMORTIGUADORES Y STRUTS

Año	Notas de Aplicación										
		Ultra	ProGuard\ Guardian	Max Control\ LTV	Protector de Strut\ Bases de Strut	HiJacker\ Soporte\ Hidráulico	Ultra	ProGuard\ Guardian	Max Control\ LTV	Protector de Strut\ Bases de Strut	HiJacker\ Soporte\ Hidráulico

## NISSAN

## NISSAN







### TITAN (cont)

04-11	Todos		G51715	....	....	143358 <sup>53</sup> 143359 <sup>70</sup>	....		....	....	....	....
	4WD		G51715	....	....	143358 <sup>53</sup> 143359 <sup>70</sup>	....		G63878	....	....	....
	RWD		G51715	....	....	143358 <sup>53</sup> 143359 <sup>70</sup>	....		G63883	....	....	....





## PEUGEOT

## PEUGEOT

### GRAND RAID

10-12	Todos		....	....	....	....	....		70009	....	....	....
03-09	Izquierdo		G52046	....	....	....	....		70009	....	....	....
	Derecho		G52047	....	....	....	....		70009	....	....	....





### PARTNER

03-09	Izquierdo		G52046	....	....	....	....		70009	....	....	....
	Derecho		G52047	....	....	....	....		70009	....	....	....











## PLYMOUTH

## PLYMOUTH

### SUBURBAN

57-61	Todos		....	82072	....	....	....		....	81469	....	....	49110 <sup>7</sup>
51-56	Todos		....	....	....	....	....		....	81469	....	....	49110 <sup>7</sup>

### TRAILDUSTER

81	Todos		....	....	77359 <sup>35</sup>	....	34052 <sup>8</sup>		....	....	....	....	43067 <sup>8</sup> 49149 <sup>7</sup>
	4WD		G63183	61632 81825	58183 77359 <sup>35</sup>	....	34052 <sup>8</sup>		G63389	61633 81342	58389 77389	....	43067 <sup>8</sup> 49149 <sup>7</sup>
	4WD		....	....	77359 <sup>35</sup>	....	70175 34052 <sup>8</sup>		....	....	....	....	43067 <sup>8</sup> 49149 <sup>7</sup>
	RWD		G63359 <sup>35</sup>	61523 <sup>35</sup> 81096 <sup>35</sup>	58359 <sup>35</sup> 77359 <sup>35</sup>	....	34052 <sup>8</sup>		G63353	61526 81091	58353	....	43067 <sup>8</sup> 49149 <sup>7</sup>
76-80	Todos		....	....	....	....	....		....	....	....	....	43067 <sup>8</sup> 49149 <sup>7</sup>
	4WD		G63183	61632 81825	58183	....	....		G63389	61633 81342	58389 77389	....	43067 <sup>8</sup> 49149 <sup>7</sup>
	4WD		....	....	....	....	70175		....	....	....	....	43067 <sup>8</sup> 49149 <sup>7</sup>
75-80	RWD		G63359 <sup>35</sup>	61523 <sup>35</sup> 81096 <sup>35</sup>	58359 <sup>35</sup> 77359 <sup>35</sup>	....	34052 <sup>8</sup>		G63353	61526 81091	58353	....	43067 <sup>8</sup> 49149 <sup>7</sup>
75	Todos		....	....	....	....	....		G63353	....	....	....	43067 <sup>8</sup> 49149 <sup>7</sup>
	4WD		G63183	61632 81825	58183	....	....		G63353	....	....	....	43067 <sup>8</sup> 49149 <sup>7</sup>
	4WD		....	....	....	....	70175		G63353	....	....	....	43067 <sup>8</sup> 49149 <sup>7</sup>
74	Todos		....	....	58183	....	....		G63353	81091	58353	....	43067 <sup>8</sup> 49149 <sup>7</sup>
	4WD		G63183	61632 81825	58183	....	....		G63353	81091	58353	....	43067 <sup>8</sup> 49149 <sup>7</sup>
	4WD		....	....	58183	....	70175		G63353	81091	58353	....	43067 <sup>8</sup> 49149 <sup>7</sup>
	RWD		....	....	58183	....	....		G63353	61526 81091	58353	....	43067 <sup>8</sup> 49149 <sup>7</sup>

7 Paquetes en pares; kit de mangueras de aire incluido

35 Es necesaria abertura en brazo de control para instalar el producto fabricado antes de agosto 1988.





70 Kit Buje y Camisa. Algunos accesorios del Equipo Original podrían ser necesitados

Texto en Negritas - Número de Parte Nuevo / Futuro

8 Paquetes en pares

53 Montaje de Strut. Es probable reutilizar algunas partes del E.O.

# AMORTIGUADORES Y STRUTS

Año	Notas de Aplicación										
			Ultra	ProGuard\ Guardian	Max Control\ LTV	Protector de Strut\ Bases de Strut	HiJacker\ Soporte\ Hidráulico		Ultra	ProGuard\ Guardian	Max Control\ LTV



## PLYMOUTH

## PLYMOUTH



### TRAILDUSTER ESTABILIZADORES DE DIRECCIÓN

		Delantero					Trasero				
75-81	4WD, Estabilizador de Dirección Sistema Sencillo	6803SE <sup>84</sup>					....				
74-81	Estabilizador de Dirección Sistema Dual; Exc. Servofreno montado del lado del Eje del Conductor	6802SE <sup>84</sup>					....				
74	Estabilizador de Dirección Sistema Sencillo	6803SE <sup>84</sup>					....				







### VAN 1/2 TON, PB SERIES

74-83	Todos		G63359 <sup>35</sup>	61523 <sup>35</sup> 81096 <sup>35</sup>	58359 <sup>35</sup> 77359 <sup>35</sup>	....	34052 <sup>8</sup>		G63413	61522 <sup>6</sup> 81496	58413 77413	....	43085 <sup>9</sup> 49212 <sup>7</sup>
-------	-------	---	----------------------	--	--	------	--------------------	---	--------	-----------------------------	----------------	------	--

### VAN 3/4 TON, PB SERIES

74-83	Todos		G63359 <sup>35</sup>	61523 <sup>35</sup> 81096 <sup>35</sup>	58359 <sup>35</sup> 77359 <sup>35</sup>	....	34052 <sup>8</sup>		G63413	61522 <sup>6</sup> 81496	58413 77413	....	43085 <sup>9</sup> 49212 <sup>7</sup>
-------	-------	---	----------------------	--	--	------	--------------------	---	--------	-----------------------------	----------------	------	--









### VAN 1 TON, PB SERIES

74-83	Todos		....	....	....	....	....		G63413	61522 <sup>6</sup> 81496	58413 77413	....	43085 <sup>9</sup> 49212 <sup>7</sup>
	Con Eje Delantero 4000#		G63360 <sup>35</sup>	61650 81834	58360	....	....		G63413	61522 <sup>6</sup> 81496	58413 77413	....	43085 <sup>9</sup> 49212 <sup>7</sup>
	Exc. Eje Delantero 4000#		G63359 <sup>35</sup>	61523 <sup>35</sup> 81096 <sup>35</sup>	58359 <sup>35</sup> 77359 <sup>35</sup>	....	34052 <sup>8</sup>		G63413	61522 <sup>6</sup> 81496	58413 77413	....	43085 <sup>9</sup> 49212 <sup>7</sup>













## RAM

## RAM

### 1500 (SEE DODGE RAM 1500)

13-14	4WD		G51856	....	....	....	....		G64044	....	....	....	....
11-14	Todos		....	....	....	....	....		G64044	....	....	....	....
	RWD		G64043	....	....	....	....		G64044	....	....	....	....
11-12	4WD		G51856	....	....	143389 <sup>33</sup>	....		G64044	....	....	....	....





### 2500 (SEE DODGE RAM 2500)

11-13	Todos		....	....	....	....	....		....	....	77950	....	....
	RWD		....	....	77949	....	....		....	....	77950	....	....
	RWD, Standard Cab Pickup		....	....	....	....	....		G63970	....	77950	....	....
13	4WD		....	....	77948	....	....		G64013	....	77950	....	....
11-12	4WD		....	....	77948	....	....		....	61716	77950	....	....
	4WD, PBV 8800		....	....	....	....	....		G64013	....	77950	....	....



## RENAULT

## RENAULT

### KANGOO

09-12	Todos		....	....	....	....	....		70002	....	....	....	....
03-08	Todos		G52040	....	....	....	....		70002	....	....	....	....



### TRAFIC

07-11	Todos		G52216	....	....	....	....		G64061	....	....	....	....
-------	-------	---	--------	------	------	------	------	---	--------	------	------	------	------

## TOYOTA

## TOYOTA

### 4RUNNER

03-12	Todos		....	....	....	143383 <sup>33</sup>	....		....	....	....	....	....
-------	-------	---	------	------	------	----------------------	------	---	------	------	------	------	------

6 Se recomienda que cuando se reemplacen amortiguadores "quad", los 4 sean de la misma serie.

8 Paquetes en pares

53 Montaje de Strut. Es probable reutilizar algunas partes del E.O.



7 Paquetes en pares; kit de mangueras de aire incluido

35 Es necesaria abertura en brazo de control para instalar el producto fabricado antes de agosto 1988.

84 Amortiguador de repuesto para los vehículos con el kit de montaje aftermarket GRC

Texto en Negritas - Número de Parte Nuevo / Futuro

# AMORTIGUADORES Y STRUTS

Año	Notas de Aplicación										
		Ultra	ProGuard\ Guardian	Max Control\ LTV	Protector de Strut\ Bases de Strut	HiJacker\ Soporte\ Hidráulico	Ultra	ProGuard\ Guardian	Max Control\ LTV	Protector de Strut\ Bases de Strut	HiJacker\ Soporte\ Hidráulico

## TOYOTA

## TOYOTA

### 4RUNNER (cont)

03-12	Exc. Suspensión X-REAS; Exc. Modelos Deportivos	↓	G51739	....	....	143383 <sup>53</sup>	....	....	....	....	....	....	
03-11	Exc. Suspensión X-REAS	↓	....	....	....	143383 <sup>53</sup>	....	↓	G63885	....	....	....	
03	Limited	↓	....	....	....	143383 <sup>53</sup>	....	↓	G63885	....	....	....	
96-02	Todos	↓	G51077	....	....	....	....	↓	G63726	....	77726	....	49387 <sup>7</sup>
	Exc. HD	↓	G51077	....	....	142838 <sup>53</sup>	....	↓	G63726	....	77726	....	49387 <sup>7</sup>
	HD	↓	G51077	....	....	143325 <sup>53</sup>	....	↓	G63726	....	77726	....	49387 <sup>7</sup>
90-95	Todos	↓	G63547	61552 81870	77479	....	....	↓	G63548	61588 81906	77726	....	49388 <sup>7</sup>
	Exc. HD	↓	G63547	61552 81870	77479	142838 <sup>53</sup>	....	↓	G63548	61588 81906	77726	....	49388 <sup>7</sup>
86-89	Todos	↓	G63479	61552 81870	77479	....	....	↓	G63494	61510 81871	77494	....	....
84-85	Todos	↓	G63404	....	....	....	....	↓	G63494	61510 81871	77494	....	....

### 4RUNNER ESTABILIZADORES DE DIRECCIÓN

		Delantero	Trasero
84-85	Estabilizador de Dirección Sistema Sencillo	6803SE <sup>84</sup>	....

### FJ CRUISER

11-12	4WD	↓	G51739	....	....	143383 <sup>53</sup>	....	↓	G64030	....	....	....
07-12	Todos	↓	G51739	....	....	143383 <sup>53</sup>	....	↓	....	....	....	....
	RWD	↓	G51739	....	....	143383 <sup>53</sup>	....	↓	G64029	....	....	....
07-09	4WD	↓	G51739	....	....	143383 <sup>53</sup>	....	↓	G64030	....	....	....

### PICKUP

93-95	RWD, Exc. 1 Ton	↓	G63903	61509 81541	77903	....	....	↓	G63907	61500 81147	77907	....	49310 <sup>7</sup>
86-95	4WD, Exc. Kit de Levantamiento	↓	G63479	61552 81870	77479	....	....	↓	G63494	61510 81871	77494	....	....
85-95	RWD	↓	....	....	....	....	....	↓	....	....	....	....	43048 <sup>8</sup>
	RWD Exc. 1 Ton	↓	....	....	....	....	....	↓	....	....	....	....	70163
85-92	RWD, 1 Ton	↓	....	61509	....	....	....	↓	G63492	61506 81318	77492	....	49311 <sup>7</sup>
	RWD, Exc. 1 Ton	↓	G63903	81541	77903	....	....	↓	G63907	61500 81147	77907	....	49310 <sup>7</sup>
84-85	4WD, Exc. Kit de Levantamiento	↓	G63404	....	....	....	....	↓	G63494	61510 81871	77494	....	....
84	RWD	↓	G63903	61509 81541	77903	....	....	↓	G63907	81147	77907	....	43048 <sup>8</sup> 49310 <sup>7</sup> 70163
	RWD; Mojave	↓	....	....	....	....	....	↓	....	61500	....	....	....
80-83	4WD, Exc. Kit de Levantamiento	↓	G63404	....	....	....	....	↓	G63492	61506 81318	77492	....	49311 <sup>7</sup>
	4WD, Kit de Levantamiento de 2-3"	↓	G63444 <sup>50</sup>	....	....	....	....	↓	G63440 <sup>50</sup>	....	....	....	....
73-83	RWD, Mojave	↓	....	81750	....	....	....	↓	G63907	81147	77907	....	43048 <sup>8</sup> 49151 <sup>7</sup>
70-83	RWD; Mojave	↓	....	....	....	....	....	↓	....	....	....	....	70163

7 Paquetes en pares; kit de mangueras de aire incluido

8 Paquetes en pares





50 Para proteger la barra del pistón, se recomienda utilizar el kit Bellows No.141242. 53 Montaje de Strut. Es probable reutilizar algunas partes del E.O.

84 Amortiguador de repuesto para los vehículos con el kit de montaje aftermarket

GRC

Texto en Negritas - Número de Parte Nuevo / Futuro







# AMORTIGUADORES Y STRUTS

Año	Notas de Aplicación										
			Ultra	ProGuard\ Guardian	Max Control\ LTV	Protector de Strut\ Bases de Strut	HiJacker\ Soporte\ Hidráulico		Ultra	ProGuard\ Guardian	Max Control\ LTV

## TOYOTA

## TOYOTA





### PICKUP (cont)

70-83	RWD; Mojave		.....	61504	.....	.....	.....		.....	61500	.....	.....	.....
70-72	RWD		.....	.....	.....	.....	.....		.....	.....	.....	.....	43048 <sup>8</sup> 49151 <sup>7</sup>
	RWD, Mojave		.....	81750	.....	.....	.....		G63907	81147	77907	.....	.....











































### PICKUP ESTABILIZADORES DE DIRECCIÓN

		Delantero			Trasero	
86-95	Estabilizador de Dirección Sistema Sencillo	6802SE <sup>84</sup>			.....	
	4WD, Estabilizador de Dirección Sistema Sencillo c/ Montajes de EO	6804SE <sup>80</sup>			.....	
80-85	4WD, Estabilizador de Dirección Sistema Sencillo c/ Montajes de EO	6803SE <sup>84</sup>			.....	
79-85	RWD, Estabilizador de Dirección Sistema Sencillo	6802SE <sup>84</sup>			.....	

### T100

93-98	4WD		G63479	61552 81870	77479	.....	.....		G63660	61582	77660	.....	.....
	RWD		G63903	61509 81541	77903	.....	.....		G63173	61506	77492	.....	.....

### TACOMA

13	4WD		G51739	.....	.....	.....	.....		.....	.....	.....	.....	.....
	Base, RWD		.....	.....	.....	.....	.....		G63889	.....	.....	.....	.....
	Pre Runner		G51739	.....	.....	.....	.....		.....	.....	.....	.....	.....
05-12	Todos		.....	.....	.....	143383 <sup>53</sup>	.....		.....	.....	.....	.....	.....
	Base, RWD		.....	.....	.....	143383 <sup>53</sup>	.....		G63889	.....	.....	.....	.....
12	4WD		G51739	.....	.....	143383 <sup>53</sup>	.....		.....	.....	.....	.....	.....
	Pre Runner		G51739	.....	.....	143383 <sup>53</sup>	.....		.....	.....	.....	.....	.....
05-11	4WD		G51739	.....	.....	143383 <sup>53</sup>	.....		G64006	.....	.....	.....	.....
	Pre Runner		G51739	.....	.....	143383 <sup>53</sup>	.....		G64007	.....	.....	.....	.....
	X-Runner, Izquierdo		G51739	.....	.....	143383 <sup>53</sup>	.....		G64004	.....	.....	.....	.....
	X-Runner, Derecho		G51739	.....	.....	143383 <sup>53</sup>	.....		G64005	.....	.....	.....	.....
05-09	Modelos Base y X-Runner Izquierdo		G51853	.....	.....	143383 <sup>53</sup>	.....		.....	.....	.....	.....	.....
	Modelos Base y X-Runner Derecho		G51854	.....	.....	143383 <sup>53</sup>	.....		.....	.....	.....	.....	.....
01-04	S-Runner		G63937	.....	.....	.....	.....		G63689	61510	.....	.....	.....
	S-Runner, Exc. Off Road Package		.....	61606 81908	77937	.....	.....		.....	.....	.....	.....	.....
98-04	Pre Runner		G51077	.....	.....	.....	.....		.....	81871	77494	.....	.....
	Pre Runner, Exc. Upgrade HD		.....	.....	.....	.....	.....		G63494	.....	.....	.....	.....
	Pre Runner, Izquierdo		.....	.....	.....	.....	.....		.....	61699	.....	.....	.....
	Pre Runner, Derecho		.....	.....	.....	.....	.....		.....	61700	.....	.....	.....
95-04	4WD		G51077	.....	.....	143325 <sup>53</sup>	.....		.....	81871	77494	.....	.....
	4WD, Exc. Upgrade HD		.....	.....	.....	.....	.....		G63494	.....	.....	.....	.....

7 Paquetes en pares; kit de mangueras de aire incluido

53 Montaje de Strut. Es probable reutilizar algunas partes del E.O.





84 Amortiguador de repuesto para los vehículos con el kit de montaje aftermarket GRC

Texto en Negritas - Número de Parte Nuevo / Futuro

8 Paquetes en pares

80 No requiere soportes para el montaje, instalar sobre montajes de EO Vea Ref. C para Botas.















# AMORTIGUADORES Y STRUTS

Año	Notas de Aplicación										
		 Ultra	ProGuard\ Guardian	Max Control\ LTV	Protector de Strut\ Bases de Strut	HiJacker\ Soporte\ Hidráulico	 Ultra	ProGuard\ Guardian	Max Control\ LTV	Protector de Strut\ Bases de Strut	HiJacker\ Soporte\ Hidráulico









## TOYOTA

## TOYOTA





















### TACOMA (cont)

04	Base, 4WD		....	....	....	....		....	61510	....	....	....
	Base, RWD		G63937	....	....	....		G63689	61500	....	....	....
	Base, RWD, Exc. Off Road Package		....	61606 81908	77937	....	....	....	....	....	....	....
95-03	DLX, 4WD		....	....	....	....		....	61510	....	....	....
	DLX, RWD		G63937	....	....	....		G63689	61500	....	....	....
	DLX, RWD, Exc. Off Road Package		....	61606 81908	77937	....	....	....	....	....	....	....
98-00	Limited		....	....	....	....		....	61510	....	....	....
	SR5, 4WD		....	....	....	....		....	61500	....	....	....













### TUNDRA

13	Todos		G51855	....	....	....		G64038	....	....	....	....
12	Todos		G51855	....	....	143339 <sup>53</sup>		G64038	....	....	....	....
07-11	Todos		G51855	....	....	143339 <sup>53</sup>		G64038	....	....	143340 <sup>53</sup>	....
00-06	Todos		G51477	....	....	143325 <sup>53</sup>		G63815	....	77815	....	....

### VAN

87-89	4WD		G63612	61545	....	....		....	....	....	....	....
	Coil(RearSpringType)		....	....	....	....		G63484	81542	....	....	....
	RWD		G63900	61529	....	....		....	....	....	....	....
	RWD, Coil(RearSpringType)		....	....	....	....		....	61513	....	....	....
87-88	Leaf Rear Spring Type		....	....	....	....		....	....	....	....	70163
	Leaf(RearSpringType)		....	....	....	....		G63907	61500 81147	77907	....	43048 <sup>8</sup> 49310 <sup>7</sup>
84-86	Todos		G63900	61529	....	....		....	....	....	....	....
	Coil(RearSpringType)		G63900	61529	....	....		G63484	61513 81542	....	....	....
	Leaf Rear Spring Type		G63900	61529	....	....		....	....	....	....	70163
	Leaf(RearSpringType)		G63900	61529	....	....		G63907	61500 81147	77907	....	43048 <sup>8</sup> 49310 <sup>7</sup>





### VAN WAGON

88	Todos		....	....	....	....		....	61500	....	....	....
	Resorte Trasero		....	....	....	....		....	61513 61500	....	....	....
	Coil(RearSpringType), Coil(FrontSpringType)		G63612	....	....	....		G63484	81542 61500	....	....	....
	Leaf Rear Spring Type		....	....	....	....		....	61500	....	....	70163
	Leaf(RearSpringType), Leaf(FrontSpringType)		G63900	....	....	....		G63907	81147 61500	77907	....	43048 <sup>8</sup> 49310 <sup>7</sup>
	RWD		....	61529	....	....	....		....	61500	....	....

## VOLKSWAGEN

## VOLKSWAGEN

### CRAFTER VAN





08-13	30-35		G52343	....	....	....		G64091	....	....	....	....
10-11	50		G52341	....	....	....		G64089	....	....	....	....

7 Paquetes en pares; kit de mangueras de aire incluido  
53 Montaje de Strut. Es probable reutilizar algunas partes del E.O.







8 Paquetes en pares



# AMORTIGUADORES Y STRUTS





Año	Notas de Aplicación										
			Ultra	ProGuard\ Guardian	Max Control\ LTV	Protector de Strut\ Bases de Strut	HiJacker\ Soporte\ Hidráulico		Ultra	ProGuard\ Guardian	Max Control\ LTV

## VOLKSWAGEN EUROVAN

11-12	TDI Diesel		....	....	....	....	....		G64090	....	....	....	....
05-10	TDI Diesel		G52342	....	....	....	....		G64090	....	....	....	....
00-04	Todos		69581	....	....	....	....		69582	....	....	....	....

## VOLKSWAGEN









### SAFARI

74-80	1.6L 4Cyl (98) 1BBL		....	82005	....	....	42161		....	82001	....	....	42094
73	1.5L 4Cyl (92) 1BBL		....	82005	....	....	42161		....	82001	....	....	42094





### SAFARI ESTABILIZADORES DE DIRECCIÓN

									Delantero		Trasero	
73-80	Todos								14004		....	

### TRANSPORTER

10-13	Todos		G52342	....	....	....	....		G64090	....	....	....	....
70-79	Todos		....	82031	....	....	....		....	82032	....	....	....
68-69	Todos		....	82001	....	....	....		....	82032	....	....	....
56-67	Todos		....	82001	....	....	....		....	82001	....	....	....

### VANAGON

80-91	RWD		69861	....	....	....	....		69858	....	....	....	....
86-89	4WD		....	....	....	....	....		G63454	61539 81581	....	....	49215'

7 Paquetes en pares; kit de mangueras de aire incluido

Lista numérica

Amort.	POP	No. Alternativo	Montaje Accesorio
Pos.	Año	Aplicación	

**Amortiguadores de Dirección**

Amort.	POP	No. Alternativo	Montaje Accesorio
Pos.	Año	Aplicación	
<b>6801SE</b>	<b>A</b>	<b>500498,142037</b>	
F	83-94	<b>CHEVROLET</b> BLAZER, S MODELS Todos Estabilizador de Dirección Sistema Sencillo; con orificio de montaje de EO en brazo de dirección	
F	83-04	S10 4x4 Estabilizador de Dirección Sistema Sencillo; con orificio de montaje de EO en brazo de dirección	
F	83-91	<b>GMC</b> S15 JIMMY Todos Estabilizador de Dirección Sistema Sencillo; con orificio de montaje de EO en brazo de dirección	
F	91-93	SONOMA / S15 Todos Estabilizador de Dirección Sistema Sencillo; con orificio de montaje de EO en brazo de dirección	
F	82-90	SONOMA / S15 4x2 Tracción trasera Estabilizador de Dirección Sistema Sencillo; con orificio de montaje de EO en brazo de dirección	
F	91	SYCLONE Todos Estabilizador de Dirección Sistema Sencillo; con orificio de montaje de EO en brazo de dirección	
F	84-00	<b>JEEP</b> CHEROKEE Todos Estabilizador de Dirección Sistema Sencillo; con orificio de montaje de EO en brazo de dirección	
F	86-92	COMANCHE Todos Estabilizador de Dirección Sistema Sencillo; con orificio de montaje de EO en brazo de dirección	
F	97-06	WRANGLER TJ (Código plataforma del fabricante) Estabilizador de Dirección Sistema Sencillo; con orificio de montaje de EO en brazo de dirección	
F	94-95	WRANGLER YJ (Código plataforma del fabricante) Estabilizador de Dirección Sistema Sencillo; con orificio de montaje de EO en brazo de dirección	
F	87-92	WRANGLER YJ (Código plataforma del fabricante) Estabilizador de Dirección Sistema Sencillo; con orificio de montaje de EO en brazo de dirección	

Amort.	POP	No. Alternativo	Montaje Accesorio
Pos.	Año	Aplicación	
<b>6802SE</b>	<b>C</b>	<b>141998</b>	
F	79-86	<b>CHEVROLET</b> BLAZER 4x4 Estabilizador de Dirección Sistema Dual	
F	79-84	BLAZER 4x2 Tracción trasera Estabilizador de Dirección Sistema Dual	
F	73-86	PICKUP 1/2 TON, C10 Todos Estabilizador de Dirección Sistema Sencillo	
F	67-86	PICKUP 1/2 TON, K10 Todos Estabilizador de Dirección Sistema Dual	
F	87	PICKUP 1/2 TON, R10 Todos Estabilizador de Dirección Sistema Sencillo	
F	87	PICKUP 1/2 TON, V10 Todos Estabilizador de Dirección Sistema Dual	
F	82-86	PICKUP 1 TON, C30 6.2L 8Cyl V (379) Estabilizador de Dirección Sistema Sencillo c/ Cooler	
F	73-86	PICKUP 1 TON, C30 4.8L 6Cyl L (292) Estabilizador de Dirección Sistema Sencillo c/ Cooler	
F	73-86	PICKUP 1 TON, C30 5.7L 8Cyl V (350) Estabilizador de Dirección Sistema Sencillo c/ Cooler	
F	86	PICKUP 1 TON, C30 5.0L 8Cyl V (305) Estabilizador de Dirección Sistema Sencillo c/ Cooler	
F	78-80	PICKUP 1 TON, C30 4.1L 6Cyl L (250) Estabilizador de Dirección Sistema Sencillo c/ Cooler	
F	78-79	PICKUP 1 TON, C30 5.0L 8Cyl V (305) Estabilizador de Dirección Sistema Sencillo c/ Cooler	
F	76-79	PICKUP 1 TON, C30 6.6L 8Cyl V (400) Estabilizador de Dirección Sistema Sencillo c/ Cooler	
F	73-75	PICKUP 1 TON, C30 4.1L 6Cyl L (250) Estabilizador de Dirección Sistema Sencillo c/ Cooler	

Amortiguadores de Dirección

Amort.	POP	No. Alternativo	Montaje Accesorio
Pos.	Año	Aplicación	

Amort.	POP	No. Alternativo	Montaje Accesorio
Pos.	Año	Aplicación	
<b>6802SE</b>	<b>C</b>	<b>-continued 141998</b>	
F	73	PICKUP 1 TON, C30 5.0L 8Cyl V (307) Estabilizador de Dirección Sistema Sencillo c/ Cooler	
F	61-72	PICKUP 1 TON, C30 Todos Estabilizador de Dirección Sistema Sencillo	
F	77-86	PICKUP 1 TON, K30 Todos Estabilizador de Dirección Sistema Dual	
F	87-88	PICKUP 1 TON, R30 4.8L 6Cyl L (292) Estabilizador de Dirección Sistema Sencillo c/ Cooler	
F	87-88	PICKUP 1 TON, R30 5.7L 8Cyl V (350) Estabilizador de Dirección Sistema Sencillo c/ Cooler	
F	87-88	PICKUP 1 TON, R30 6.2L 8Cyl V (379) Estabilizador de Dirección Sistema Sencillo c/ Cooler	
F	89-91	PICKUP 1 TON, R3500 5.7L 8Cyl V (350) Estabilizador de Dirección Sistema Sencillo c/ Cooler	
F	63-74	PICKUP 3/4 TON, C20 Todos Estabilizador de Dirección Sistema Sencillo	
F	67-86	PICKUP 3/4 TON, K20 Todos Estabilizador de Dirección Sistema Dual	
F	87-88	PICKUP 3/4 TON, R20 Todos Estabilizador de Dirección Sistema Sencillo	
F	89	PICKUP 3/4 TON, R2500 Todos Estabilizador de Dirección Sistema Sencillo	
F	87	PICKUP 3/4 TON, V20 Todos Estabilizador de Dirección Sistema Dual	
F	82-03	S10 4x2 Tracción trasera Estabilizador de Dirección Sistema Sencillo	
F	68-86	SUBURBAN 1/2 TON, C10 Todos Estabilizador de Dirección Sistema Sencillo	
F	68-86	SUBURBAN 1/2 TON, K10 Todos Estabilizador de Dirección Sistema Dual	
F	87-88	SUBURBAN 1/2 TON, R10 Todos Estabilizador de Dirección Sistema Dual	
F	89-91	SUBURBAN 1/2 TON, R1500 Todos Estabilizador de Dirección Sistema Sencillo	
F	68-86	SUBURBAN 3/4 TON, C20 Todos Estabilizador de Dirección Sistema Sencillo	
F	68-86	SUBURBAN 3/4 TON, K20 Todos Estabilizador de Dirección Sistema Dual	
F	87-88	SUBURBAN 3/4 TON, R20 Todos Estabilizador de Dirección Sistema Sencillo	
F	89-91	SUBURBAN 3/4 TON, R2500 Todos Estabilizador de Dirección Sistema Sencillo	
F	87-88	SUBURBAN 3/4 TON, V20 Todos Estabilizador de Dirección Sistema Dual	
F	89-91	SUBURBAN 3/4 TON, V2500 Todos Estabilizador de Dirección Sistema Dual	
F	70-95	VAN 1/2 TON, G / EXPRESS Todos Estabilizador de Dirección Sistema Sencillo	
F	71-95	VAN 1 TON, G / EXPRESS Todos Estabilizador de Dirección Sistema Sencillo	
F	70-95	VAN 3/4 TON, G / EXPRESS Todos Estabilizador de Dirección Sistema Sencillo	
F	86-89	<b>DODGE</b> PICKUP 1/2 TON, D100 SERIES Todos Estabilizador de Dirección Sistema Sencillo	
F	72-79	PICKUP 1/2 TON, D100 SERIES Todos Estabilizador de Dirección Sistema Sencillo	
F	60-71	PICKUP 1/2 TON, D100 SERIES Todos Estabilizador de Dirección Sistema Sencillo c/ Eje de Viga en I	
F	90-93	PICKUP 1/2 TON, W100 SERIES Todos Estabilizador de Dirección Sistema Sencillo	

Lista numérica

Amort.	POP	No. Alternativo	Montaje Accesorio
Pos.	Año	Aplicación	

Amort.	POP	No. Alternativo	Montaje Accesorio
Pos.	Año	Aplicación	
<b>6802SE</b>	<b>C</b>	<b>-continued 141998</b>	
F	60-86	PICKUP 1/2 TON, W100 SERIES Todos Estabilizador de Dirección Sistema Dual; Exc. Servofreno montado del lado del Eje del Conductor	
F	75-93	PICKUP 1 TON, D300 SERIES Todos Estabilizador de Dirección Sistema Sencillo	
F	72-74	PICKUP 1 TON, D300 SERIES Todos Estabilizador de Dirección Sistema Sencillo c/ Suspensión Delantera de Resorte Helicoidal	
F	60-71	PICKUP 1 TON, D300 SERIES Todos Estabilizador de Dirección Sistema Sencillo c/ Eje de Viga en I	
F	90-93	PICKUP 1 TON, W300 SERIES Todos Estabilizador de Dirección Sistema Sencillo	
F	60-86	PICKUP 1 TON, W300 SERIES Todos Estabilizador de Dirección Sistema Dual; Exc. Servofreno montado del lado del Eje del Conductor	
F	73-93	PICKUP 3/4 TON, D200 SERIES Todos Estabilizador de Dirección Sistema Sencillo	
F	60-71	PICKUP 3/4 TON, D200 SERIES Todos Estabilizador de Dirección Sistema Sencillo c/ Eje de Viga en I	
F	90-93	PICKUP 3/4 TON, W200 SERIES Todos Estabilizador de Dirección Sistema Sencillo	
F	60-86	PICKUP 3/4 TON, W200 SERIES Todos Estabilizador de Dirección Sistema Dual; Exc. Servofreno montado del lado del Eje del Conductor	
F	83-93	PICKUP, RAM 50 4x2 Tracción trasera Estabilizador de Dirección Sistema Sencillo	
F	87-89	RAIDER Todos Estabilizador de Dirección Sistema Sencillo	
F	87-93	RAMCHARGER 4x2 Tracción trasera Estabilizador de Dirección Sistema Sencillo	
F	74-86	RAMCHARGER Todos Estabilizador de Dirección Sistema Dual; Exc. Servofreno montado del lado del Eje del Conductor	
F	71	VAN 1/2 TON, A / B SERIES / RAM Todos Estabilizador de Dirección Sistema Sencillo c/ Eje de Viga en I	
F	71	VAN 1 TON, A / B SERIES / RAM Todos Estabilizador de Dirección Sistema Sencillo c/ Eje de Viga en I	
F	71	VAN 3/4 TON, A / B SERIES / RAM Todos Estabilizador de Dirección Sistema Sencillo c/ Eje de Viga en I	
F	92-96	<b>FORD</b> BRONCO Todos Estabilizador de Dirección Sistema Sencillo	
F	80-91	BRONCO Todos	
F	78-79	BRONCO Todos Estabilizador de Dirección Sistema Dual; Exc. Barra Estabilizadora	
F	84-90	BRONCO II Todos Estabilizador de Dirección Sistema Sencillo	
F	61-67	ECONOLINE VAN Van	
F	91-94	EXPLORER Todos	
F	89-91	F59 Todos Estabilizador de Dirección Sistema Sencillo, Superduty Motorhome	
F	57-59	F SERIES Todos Estabilizador de Dirección Sistema Sencillo c/ Eje de Viga en I	
F	50-55	F SERIES Todos Estabilizador de Dirección Sistema Sencillo c/ Eje de Viga en I	
F	89-91	MOTORHOME CHASSIS / F53 Todos Estabilizador de Dirección Sistema Sencillo Motorhome	
F	80-83	PICKUP 1/2 TON, F-100 4x2 Tracción trasera Estabilizador de Dirección Sistema Sencillo	
F	77-79	PICKUP 1/2 TON, F-100 Todos Estabilizador de Dirección Sistema Dual; Exc. Barra Estabilizadora	
F	75-79	PICKUP 1/2 TON, F-100 4x2 Tracción trasera Estabilizador de Dirección Sistema Sencillo c/ Eje de Doble Viga en I	
F	75-76	PICKUP 1/2 TON, F-100 4x4 Estabilizador de Dirección Sistema Dual; Exc. Barra Estabilizadora	

## Lista numérica

Amort.	POP	No. Alternativo	Montaje Accesorio
Pos.	Año	Aplicación	
<b>6802SE</b>	C	-continued	141998
F 65-74	PICKUP 1/2 TON, F-100	Todos 4x2 Tracción trasera; Estabilizador de Dirección Sistema Sencillo; con Ejes Paralelos de Viga en I	
F 60-64	PICKUP 1/2 TON, F-100	Todos 4x2 Tracción trasera; Estabilizador de Dirección Sistema Sencillo; con Eje de Viga en I	
F 94-96	PICKUP 1/2 TON, F-150	4x4 Estabilizador de Dirección Sistema Sencillo c/ Vigas Dobles de Tracción	
F 90-93	PICKUP 1/2 TON, F-150	Todos Estabilizador de Dirección Sistema Sencillo	
F 80-89	PICKUP 1/2 TON, F-150	Todos Estabilizador de Dirección Sistema Dual; Exc. Barra Estabilizadora	
F 77-79	PICKUP 1/2 TON, F-150	Todos Estabilizador de Dirección Sistema Dual; Exc. Barra Estabilizadora	
F 75-76	PICKUP 1/2 TON, F-150	4x2 Tracción trasera	
F 90-92	PICKUP 1/2 TON, F	SUPERDUTY Todos Estabilizador de Dirección Sistema Dual	
F 92-96	PICKUP 1 TON, F-350 / SUPERDUTY 4x2	Tracción trasera Estabilizador de Dirección Sistema Dual	
F 89-91	PICKUP 1 TON, F-350 / SUPERDUTY 4x2	Tracción trasera Estabilizador de Dirección Sistema Sencillo	
F 82-88	PICKUP 1 TON, F-350 / SUPERDUTY	Todos Estabilizador de Dirección Sistema Sencillo, c/ Barra Estabilizadora	
F 79-81	PICKUP 1 TON, F-350 / SUPERDUTY 4x2	Tracción trasera Estabilizador de Dirección Sistema Dual	
F 75-78	PICKUP 1 TON, F-350 / SUPERDUTY	Todos Estabilizador de Dirección Sistema Dual	
F 65-74	PICKUP 1 TON, F-350 / SUPERDUTY	Todos Estabilizador de Dirección Sistema Sencillo c/ Eje de Doble Viga en I	
F 60-64	PICKUP 1 TON, F-350 / SUPERDUTY	Todos Estabilizador de Dirección Sistema Sencillo c/ Eje de Viga en I	
F 80-96	PICKUP 3/4 TON, F-250 / SUPERDUTY 4x4	Estabilizador de Dirección Sistema Sencillo	
F 73-79	PICKUP 3/4 TON, F-250 / SUPERDUTY 4x2	Tracción trasera Estabilizador de Dirección Sistema Sencillo	
F 68-73	PICKUP P350	Todos Estabilizador de Dirección Sistema Sencillo	
F 83-97	RANGER	Todos Estabilizador de Dirección Sistema Sencillo	
F 69-74	VAN 1/2 TON, ECONOLINE / CLUB WAGON	Todos Estabilizador de Dirección Sistema Sencillo c/ Eje de Doble Viga en I	
F 68	VAN 1/2 TON, ECONOLINE / CLUB WAGON	Todos Estabilizador de Dirección Sistema Sencillo c/ Eje de Viga en I	
F 69-74	VAN 3/4 TON, ECONOLINE / CLUB WAGON / SUPERDUTY	Todos Estabilizador de Dirección Sistema Sencillo c/ Eje de Viga en I	
F 68	VAN 3/4 TON, ECONOLINE / CLUB WAGON / SUPERDUTY	Todos Estabilizador de Dirección Sistema Sencillo c/ Eje de Viga en I	
F 73-91	<b>GMC JIMMY</b>	Todos Amortiguador de reemplazo para vehículos con el kit de montaje de repuesto GRC	
F 70-72	JIMMY 4x4	Estabilizador de Dirección Sistema Dual K5	
F 70-72	JIMMY 4x2	Tracción trasera	
F 73-86	PICKUP 1/2 TON, C15 / C1500	Todos Estabilizador de Dirección Sistema Sencillo	
F 69-86	PICKUP 1/2 TON, K15 / K1500	Todos Estabilizador de Dirección Sistema Dual	
F 87	PICKUP 1/2 TON, R1500	Todos Estabilizador de Dirección Sistema Sencillo	
F 87	PICKUP 1/2 TON, V1500	Todos Estabilizador de Dirección Sistema Dual	

## Amortiguadores de Dirección

Amort.	POP	No. Alternativo	Montaje Accesorio
Pos.	Año	Aplicación	
<b>6802SE</b>	C	-continued	141998
F 75-86	PICKUP 1 TON, C35/3500	Crew Cab Pickup	
F 72-74	PICKUP 1 TON, C35/3500	Todos	
F 67-86	PICKUP 3/4 TON, C25 / C2500	Todos Estabilizador de Dirección Sistema Sencillo	
F 67-86	PICKUP 3/4 TON, K25 / K2500	Todos Estabilizador de Dirección Sistema Dual	
F 87-89	PICKUP 3/4 TON, R2500	Todos Estabilizador de Dirección Sistema Sencillo	
F 87	PICKUP 3/4 TON, V2500	Todos AN49	
F 82-93	SONOMA / S15 4x2	Tracción trasera Estabilizador de Dirección Sistema Sencillo	
F 68-86	SUBURBAN 1/2 TON, C15 / C1500	Todos Estabilizador de Dirección Sistema Sencillo	
F 68-86	SUBURBAN 1/2 TON, K15 / K1500	Todos Estabilizador de Dirección Sistema Dual	
F 87-91	SUBURBAN 1/2 TON, R1500	Todos Estabilizador de Dirección Sistema Sencillo	
F 87-91	SUBURBAN 1/2 TON, V1500	Todos Estabilizador de Dirección Sistema Dual	
F 68-86	SUBURBAN 3/4 TON, C25 / C2500	Todos Estabilizador de Dirección Sistema Sencillo	
F 68-86	SUBURBAN 3/4 TON, K25 / K2500	Todos Estabilizador de Dirección Sistema Dual	
F 87-91	SUBURBAN 3/4 TON, R2500	Todos Estabilizador de Dirección Sistema Sencillo	
F 87-91	SUBURBAN 3/4 TON, V2500	Todos Estabilizador de Dirección Sistema Dual	
F 70-95	VAN 1/2 TON, G / SAVANNA	Todos Estabilizador de Dirección Sistema Sencillo	
F 71-95	VAN 1 TON, G / SAVANNA	Todos Estabilizador de Dirección Sistema Sencillo	
F 70-95	VAN 3/4 TON, G / SAVANNA	Todos Estabilizador de Dirección Sistema Sencillo	
F 74	<b>INTERNATIONAL</b>	100 Todos	
F 75	150	Todos	
F 74-75	200	Todos	
F 68-69	908B	Todos Estabilizador de Dirección Sistema Sencillo 1/2 Ton, 3/4 Ton & Travelall	
F 68-69	908C	Todos Estabilizador de Dirección Sistema Sencillo 1/2 Ton, 3/4 Ton & Travelall	
F 68-69	1000B	Todos Estabilizador de Dirección Sistema Sencillo 1/2 Ton, 3/4 Ton & Travelall	
F 68-69	1000C	Todos Estabilizador de Dirección Sistema Sencillo 1/2 Ton, 3/4 Ton & Travelall	
F 69-70	1000D	Todos Estabilizador de Dirección Sistema Sencillo 1/2 Ton, 3/4 Ton & Travelall	
F 71-73	1010	Todos Estabilizador de Dirección Sistema Sencillo 1/2 Ton, 3/4 Ton & Travelall	
F 68-69	1100B	Todos Estabilizador de Dirección Sistema Sencillo 1/2 Ton, 3/4 Ton & Travelall	
F 68-69	1100C	Todos Estabilizador de Dirección Sistema Sencillo 1/2 Ton, 3/4 Ton & Travelall	
F 69-70	1100D	Todos Estabilizador de Dirección Sistema Sencillo 1/2 Ton, 3/4 Ton & Travelall	
F 71-73	1110	Todos Estabilizador de Dirección Sistema Sencillo 1/2 Ton, 3/4 Ton & Travelall	
F 68-69	1200B	Todos Estabilizador de Dirección Sistema Sencillo 1/2 Ton, 3/4 Ton & Travelall	
F 68-69	1200C	Todos Estabilizador de Dirección Sistema Sencillo 1/2 Ton, 3/4 Ton & Travelall	
F 69-70	1200D	Todos Estabilizador de Dirección Sistema Sencillo 1/2 Ton, 3/4 Ton & Travelall	

## Lista numérica

Amort.	POP	No. Alternativo	Montaje Accesorio
Pos.	Año	Aplicación	
<b>6802SE</b>	C	-continued	141998
F 71-73	1210	Todos Estabilizador de Dirección Sistema Sencillo 1/2 Ton, 3/4 Ton & Travelall	
F 68-69	1300B	Todos Estabilizador de Dirección Sistema Sencillo 1/2 Ton, 3/4 Ton & Travelall	
F 68-69	1300C	Todos Estabilizador de Dirección Sistema Sencillo 1/2 Ton, 3/4 Ton & Travelall	
F 69-70	1300D	Todos Estabilizador de Dirección Sistema Sencillo 1/2 Ton, 3/4 Ton & Travelall	
F 71-73	1310	Todos Estabilizador de Dirección Sistema Sencillo 1/2 Ton, 3/4 Ton & Travelall	
F 68-71	M800	Todos Estabilizador de Dirección Sistema Sencillo 1/2 & 3/4 Ton c/ Eje de Viga en I	
F 68-72	M1100 / M1200	Todos Estabilizador de Dirección Sistema Sencillo 1/2 & 3/4 Ton c/ Eje de Viga en I	
F 69	M1400	Todos Estabilizador de Dirección Sistema Sencillo 1/2 & 3/4 Ton c/ Eje de Viga en I	
F 75	TRAVELALL 4x2	Tracción trasera	
F 66-83	<b>JEEP</b> CJ5	Todos Estabilizador de Dirección Sistema Sencillo	
F 59-60	CJ5	Todos Estabilizador de Dirección Sistema Sencillo	
F 66-75	CJ6	Todos Estabilizador de Dirección Sistema Sencillo	
F 59-60	CJ6	Todos Estabilizador de Dirección Sistema Sencillo	
F 76-86	CJ7	Todos Estabilizador de Dirección Sistema Sencillo	
F 66-73	JEEPSTER	Todos Estabilizador de Dirección Sistema Sencillo	
F 81-85	SCRAMBLER / CJ8	Todos Estabilizador de Dirección Sistema Sencillo	
F 61-67	UNIVERSAL	Todos Estabilizador de Dirección Sistema Sencillo	
F 63-67	WAGONEER	Todos Exc. Suspensión Independiente Delantera	
F 74-81	<b>PLYMOUTH TRAILDUSTER</b>	Todos Estabilizador de Dirección Sistema Dual; Exc. Servofreno montado del lado del Eje del Conductor	
F 86-95	<b>TOYOTA</b> PICKUP	Todos Estabilizador de Dirección Sistema Sencillo	
F 79-85	PICKUP 4x2	Tracción trasera Estabilizador de Dirección Sistema Sencillo	
<b>6803SE</b>	D		141998
F 69-72	<b>CHEVROLET</b> BLAZER	Todos Estabilizador de Dirección Sistema Sencillo	
F 61-72	PICKUP 1/2 TON, K10	Todos Estabilizador de Dirección Sistema Sencillo	
F 61-72	PICKUP 3/4 TON, K20	Todos Estabilizador de Dirección Sistema Sencillo	
F 01-09	PICKUP 3/4 TON, SILVERADO 2500 HD	Todos 9200# PBV sin Unidad de EO - 15059138 15155638	
F 68-72	SUBURBAN 1/2 TON, K10	Todos Estabilizador de Dirección Sistema Sencillo	
F 68-72	SUBURBAN 3/4 TON, K20	Todos Estabilizador de Dirección Sistema Sencillo	
F 60-89	<b>DODGE</b> PICKUP 1/2 TON, W100 SERIES	Todos Estabilizador de Dirección Sistema Sencillo	
F 60-89	PICKUP 1 TON, W300 SERIES	Todos Estabilizador de Dirección Sistema Sencillo	
F 69-89	PICKUP 3/4 TON, W200 SERIES	Todos Estabilizador de Dirección Sistema Sencillo	
F 60-67	PICKUP 3/4 TON, W200 SERIES	Todos Estabilizador de Dirección Sistema Sencillo	
F 75-93	RAMCHARGER 4x4	Estabilizador de Dirección Sistema Sencillo	
F 74	RAMCHARGER	Todos Estabilizador de Dirección Sistema Sencillo	
F 71-87	VAN 1/2 TON, A / B SERIES / RAM	Todos Estabilizador de Dirección Sistema Sencillo	

Lista numérica

Amort.	POP	No. Alternativo	Montaje Accesorio
Pos.	Año	Aplicación	
<b>6803SE</b>	D	-continued	141998
F	71-87	VAN 1 TON, A / B SERIES / RAM Todos Estabilizador de Dirección Sistema Sencillo	
F	80-87	VAN 3/4 TON, A / B SERIES / RAM Todos Estabilizador de Dirección Sistema Sencillo	
F	78-79	VAN 3/4 TON, A / B SERIES / RAM Todos Van Charger Special	
F	71-77	VAN 3/4 TON, A / B SERIES / RAM Todos Estabilizador de Dirección Sistema Sencillo	
F	70-79	<b>FORD BRONCO</b> Todos Estabilizador de Dirección Sistema Sencillo	
F	59	F SERIES Todos Estabilizador de Dirección Sistema Sencillo F-250, F-350 sin Power Steering	
F	77-79	PICKUP 1/2 TON, F-100 Todos Estabilizador de Dirección Sistema Sencillo 4x4	
F	73-76	PICKUP 1/2 TON, F-100 4x4 Estabilizador de Dirección Sistema Sencillo	
F	60-72	PICKUP 1/2 TON, F-100 Todos Estabilizador de Dirección Sistema Sencillo 4x4	
F	76-79	PICKUP 1/2 TON, F-150 4x4 Estabilizador de Dirección Sistema Sencillo	
F	75	PICKUP 1/2 TON, F-150 Todos 4x4	
F	75-77	PICKUP 1 TON, F-350 / SUPERDUTY Manual Steering Estabilizador de Dirección Sistema Sencillo	
F	63-74	PICKUP 1 TON, F-350 / SUPERDUTY Todos Estabilizador de Dirección Sistema Sencillo	
F	62	PICKUP 1 TON, F-350 / SUPERDUTY Todos Estabilizador de Dirección Sistema Sencillo Manual Steering	
F	60-61	PICKUP 1 TON, F-350 / SUPERDUTY Todos Estabilizador de Dirección Sistema Sencillo	
F	75-77	PICKUP 3/4 TON, F-250 / SUPERDUTY 4x4, Manual Steering Estabilizador de Dirección Sistema Sencillo	
F	73-74	PICKUP 3/4 TON, F-250 / SUPERDUTY 4x4 Estabilizador de Dirección Sistema Sencillo	
F	60-72	PICKUP 3/4 TON, F-250 / SUPERDUTY Todos Estabilizador de Dirección Sistema Sencillo	
F	74-79	VAN 3/4 TON, ECONOLINE / CLUB WAGON / SUPERDUTY Todos QuadraVan Special	
F	70-72	<b>GMC JIMMY</b> 4x4 Estabilizador de Dirección Sistema Sencillo K-5	
F	69-72	PICKUP 1/2 TON, K15 / K1500 Todos Estabilizador de Dirección Sistema Sencillo	
F	67-72	PICKUP 3/4 TON, K25 / K2500 Todos Estabilizador de Dirección Sistema Sencillo	
F	68-72	SUBURBAN 1/2 TON, K15 / K1500 Todos Estabilizador de Dirección Sistema Sencillo	
F	68-72	SUBURBAN 3/4 TON, K25 / K2500 Todos Estabilizador de Dirección Sistema Sencillo	
F	75	<b>INTERNATIONAL TRAVELALL</b> 4x4 Estabilizador de Dirección Sistema Sencillo	
F	63-67	<b>JEEP GLADIATOR</b> Todos Estabilizador de Dirección Sistema Sencillo	
F	75-81	<b>PLYMOUTH TRAILDUSTER</b> 4x4 Estabilizador de Dirección Sistema Sencillo	
F	74	TRAILDUSTER Todos Estabilizador de Dirección Sistema Sencillo	
F	84-85	<b>TOYOTA 4RUNNER</b> Todos Estabilizador de Dirección Sistema Sencillo	
F	80-85	PICKUP 4x4 Estabilizador de Dirección Sistema Sencillo c/ Montajes de EO	
<b>6804SE</b>	B	-continued	500498,141397
F	75-86	<b>CHEVROLET BLAZER</b> 4x4 Estabilizador de Dirección Sistema Sencillo	

Amortiguadores de Dirección

Amort.	POP	No. Alternativo	Montaje Accesorio
Pos.	Año	Aplicación	
<b>6804SE</b>	B	-continued	500498,141397
F	75-84	<b>BLAZER</b> 4x2 Tracción trasera Estabilizador de Dirección Sistema Sencillo	
F	73-86	PICKUP 1/2 TON, K10 Todos Estabilizador de Dirección Sistema Sencillo	
F	87	PICKUP 1/2 TON, V10 Todos Estabilizador de Dirección Sistema Sencillo	
F	77-86	PICKUP 1 TON, K30 Todos Estabilizador de Dirección Sistema Sencillo	
F	73-86	PICKUP 3/4 TON, K20 Todos Estabilizador de Dirección Sistema Sencillo	
F	87	PICKUP 3/4 TON, V20 Todos Estabilizador de Dirección Sistema Sencillo	
F	73-86	SUBURBAN 1/2 TON, K10 Todos Estabilizador de Dirección Sistema Sencillo	
F	87-88	SUBURBAN 1/2 TON, R10 Todos Estabilizador de Dirección Sistema Sencillo	
F	73-86	SUBURBAN 3/4 TON, K20 Todos Estabilizador de Dirección Sistema Sencillo	
F	87-88	SUBURBAN 3/4 TON, V20 Todos Estabilizador de Dirección Sistema Sencillo	
F	89-91	SUBURBAN 3/4 TON, V2500 Todos Estabilizador de Dirección Sistema Sencillo	
F	94-95	VAN 1 TON, G / EXPRESS Todos Estabilizador de Dirección Sistema Sencillo HD c/ Eje Delantero Rígido & Tilt Hood	
F	94-97	<b>DODGE</b> PICKUP 1/2 TON, RAM 1500 4x4 Con Número de EO 52038276	
F	94-97	PICKUP 1 TON, RAM 3500 4x4 Con Número de EO 52038276	
F	94-97	PICKUP 3/4 TON, RAM 2500 4x4 Con Número de EO 52038276	
F	66-69	<b>FORD BRONCO</b> Todos Estabilizador de Dirección Sistema Sencillo	
F	73-91	<b>GMC JIMMY</b> Todos Amortiguador de reemplazo HD para vehículos con estabilizador de EO	
F	73-86	PICKUP 1/2 TON, K15 / K1500 Todos Estabilizador de Dirección Sistema Sencillo	
F	87	PICKUP 1/2 TON, V1500 Todos Estabilizador de Dirección Sistema Sencillo	
F	73-86	PICKUP 3/4 TON, K25 / K2500 Todos Estabilizador de Dirección Sistema Sencillo	
F	87	PICKUP 3/4 TON, V2500 Todos Estabilizador de Dirección Sistema Sencillo	
F	73-86	SUBURBAN 1/2 TON, K15 / K1500 Todos Estabilizador de Dirección Sistema Sencillo	
F	87-91	SUBURBAN 1/2 TON, V1500 Todos Estabilizador de Dirección Sistema Sencillo	
F	73-86	SUBURBAN 3/4 TON, K25 / K2500 Todos Estabilizador de Dirección Sistema Sencillo	
F	87-91	SUBURBAN 3/4 TON, V2500 Todos Estabilizador de Dirección Sistema Sencillo	
F	94-95	VAN 1 TON, G / SAVANNA Todos Estabilizador de Dirección Sistema Sencillo HD c/ Eje Delantero Rígido & Tilt Hood	
F	75-83	<b>JEEP CHEROKEE</b> 4x4 Estabilizador de Dirección Sistema Sencillo	
F	74	CHEROKEE Todos Estabilizador de Dirección Sistema Sencillo	
F	84-91	GRAND WAGONEER Todos Estabilizador de Dirección Sistema Sencillo	
F	74-88	J10 PICKUP Todos Estabilizador de Dirección Sistema Sencillo	
F	74-88	J20 PICKUP Todos Estabilizador de Dirección Sistema Sencillo	
F	86-95	<b>TOYOTA</b> PICKUP 4x4 Estabilizador de Dirección Sistema Sencillo c/ Montajes de EO	

Lista numérica

Amort.	POP	No. Alternativo	Montaje Accesorio
Pos.	Año	Aplicación	
<b>6805SE</b>	D	-continued	141397,141998,142000
F	79	<b>FORD</b> PICKUP 1 TON, F-350 / SUPERDUTY 4x4, Power Steering Estabilizador de Dirección Sistema Sencillo	
F	77-79	PICKUP 3/4 TON, F-250 / SUPERDUTY 4x4, Power Steering Estabilizador de Dirección Sistema Sencillo	
F	79-93	<b>GMC</b> VAN 1 TON, P SERIES Todos Step Van Forward Control & Motorhome	
F	75-78	VAN 1 TON, P SERIES Todos Chasis Motorhome	
<b>6807SE</b>	B	-continued	142038,500498
F	88-99	<b>CHEVROLET</b> PICKUP 1/2 TON, K15 / K1500 Todos Estabilizador de Dirección Sistema Sencillo	
F	91-03	PICKUP 1 TON, C35/3500 Todos Estabilizador de Dirección Sistema Sencillo Pickup HD	
F	88-00	PICKUP 1 TON, K35 / K3500 Todos Estabilizador de Dirección Sistema Sencillo	
F	88-99	PICKUP 3/4 TON, K25 / K2500 Todos Estabilizador de Dirección Sistema Sencillo	
F	92-97	SUBURBAN 1/2 TON, K15 / K1500 Todos Estabilizador de Dirección Sistema Sencillo	
F	92-97	SUBURBAN 3/4 TON, K25 / K2500 Todos Estabilizador de Dirección Sistema Sencillo	
F	92-97	<b>FORD</b> PICKUP 1 TON, F-350 / SUPERDUTY 4x2 Tracción trasera Reemplazo de Estabilizador de EO Sistema Sencillo	
F	92-97	PICKUP 3/4 TON, F-250 / SUPERDUTY 4x2 Tracción trasera Reemplazo de Estabilizador de EO Sistema Sencillo	
F	88-99	<b>GMC</b> PICKUP 1/2 TON, K15 / K1500 Todos Estabilizador de Dirección Sistema Sencillo	
F	91-93	PICKUP 1 TON, C35/3500 Todos Estabilizador de Dirección Sistema Sencillo Pickup HD	
F	88-99	PICKUP 1 TON, K35 / K3500 Todos Estabilizador de Dirección Sistema Sencillo	
F	88-99	PICKUP 3/4 TON, K25 / K2500 Todos Estabilizador de Dirección Sistema Sencillo	
F	92-95	SUBURBAN 1/2 TON, K15 / K1500 Todos Estabilizador de Dirección Sistema Sencillo	
F	92-97	SUBURBAN 3/4 TON, K25 / K2500 Todos Estabilizador de Dirección Sistema Sencillo	
<b>6826SE</b>	D	-continued	141998
F	95-97	<b>FORD</b> PICKUP 1 TON, F-350 / SUPERDUTY 4x4	
<b>6828SE</b>	A	-continued	142718
F	99-06	<b>FORD</b> PICKUP 1 TON, F-350 / SUPERDUTY 4x2 Tracción trasera	
F	99-03	PICKUP 3/4 TON, F-250 / SUPERDUTY 4x2 Tracción trasera	
<b>6846SE</b>	C	-continued	
F	97-99	<b>DODGE</b> PICKUP 1/2 TON, RAM 1500 4x4 Con Número de EO 52039280	
F	97-99	PICKUP 1 TON, RAM 3500 4x4 Con Número de EO 52039280	
F	97-99	PICKUP 3/4 TON, RAM 2500 4x4 Con Número de EO 52039280	
<b>6847SE</b>	B	-continued	143081
F	00-07	<b>DODGE</b> PICKUP 1/2 TON, RAM 1500 4x4 Con Número de EO 52106909AB, AC, AD	
F	00-07	PICKUP 1 TON, RAM 3500 4x4 Con Número de EO 52106909AB, AC, AD	
F	00-07	PICKUP 1 TON, RAM 3500 4x2 Tracción trasera Con Número de EO 52106909AB, AC, AD w/Eje Delantero Rígido	
F	00-07	PICKUP 3/4 TON, RAM 2500 4x4 Con Número de EO 52106909AB, AC, AD	

Amort.	POP	No. Alternativo	Montaje Accesorio
Pos.	Año	Aplicación	
<b>6848SE</b>	W		143163
F	95-97	NISSAN PICKUP 4x4	
F	84-97	PICKUP	
<b>6849SE</b>	W		143167
F	81-84	CHEVROLET BLAZER 4x2 Tracción trasera Sistema Sencillo sin EO	
F	82-03	S10 4x2 Tracción trasera Estabilizador de Dirección Sistema Sencillo; sin Estabilizador de Dirección de EO	
F	73-91	GMC JIMMY Todos Sin Estabilizador de Dirección de EO	
F	82-90	SONOMA / S15 4x2 Tracción trasera	
<b>6850SE</b>	W		143168
F	99-04	FORD PICKUP 1 TON, F-350 / SUPERDUTY 4x4 Exc. Unidad de EO	
F	99-04	PICKUP 3/4 TON, F-250 / SUPERDUTY 4x4 Exc. Unidad de EO	
<b>6851SE</b>	D		143177
F	84-86	CHEVROLET BLAZER 4x4 Estabilizador de Dirección Sistema Sencillo; sin orificio de montaje de EO en brazo de dirección	
F	83-04	S10 4x4 Estabilizador de Dirección Sistema Sencillo; sin orificio de montaje de EO en brazo de dirección	
F	84-04	GMC JIMMY 4x4, Power Steering Estabilizador de Dirección Sistema Sencillo; sin orificio de montaje de EO en brazo de dirección	
F	83-90	SONOMA / S15 4x4, Power Steering Estabilizador de Dirección Sistema Sencillo; sin orificio de montaje de EO en brazo de dirección	
F	92-93	TYPHOON Todos Estabilizador de Dirección Sistema Sencillo; sin orificio de montaje de EO en brazo de dirección	
<b>6852SE</b>	C		143165
F	92-99	CHEVROLET SUBURBAN 1/2 TON, C15 / C1500 4x2 Tracción trasera	
F	92-99	SUBURBAN 3/4 TON, C25 / C2500 4x2 Tracción trasera	
F	95-99	TAHOE 4x2 Tracción trasera	
F	88-99	GMC PICKUP 1/2 TON, C15 / C1500 4x2 Tracción trasera	
F	92-99	PICKUP 3/4 TON, C25 / C2500 4x2 Tracción trasera Exc. Estabilizador de Dirección de EO	
F	88-91	PICKUP 3/4 TON, C25 / C2500 4x2 Tracción trasera	
F	92-99	SUBURBAN 1/2 TON, C15 / C1500 4x2 Tracción trasera Exc. Estabilizador de Dirección de EO	
F	95-99	YUKON 4x2 Tracción trasera	
<b>6853SE</b>	B		143155
F	92-99	CHEVROLET PICKUP 1/2 TON, C15 / C1500 Todos Exc. Estabilizador de Dirección de EO	
F	92-97	PICKUP 1/2 TON, K15 / K1500 Todos Exc. Estabilizador de Dirección de EO	
F	95-00	PICKUP 1 TON, K35 / K3500 Todos Exc. Estabilizador de Dirección de EO	
F	92-99	PICKUP 3/4 TON, C25 / C2500 Todos Exc. Estabilizador de Dirección de EO	
F	99-00	PICKUP 3/4 TON, K25 / K2500 Todos Exc. Estabilizador de Dirección de EO	
F	01-09	PICKUP 3/4 TON, SILVERADO 2500 HD 4x4 PBV 9200 con Amortiguador de EO 15059138, 15155638	
F	00-05	SUBURBAN 1/2 TON, 1500 4x4 Exc. Estabilizador de Dirección de EO	
F	00-05	SUBURBAN 3/4 TON, 2500 4x4 Exc. Estabilizador de Dirección de EO	
F	95-99	SUBURBAN 3/4 TON, K25 / K2500 Todos Exc. Estabilizador de Dirección de EO	
F	01-05	TAHOE 4x4 Estilo New Body, Exc. Suspensión Z55	
F	95-00	TAHOE 4x4 Old Body Style	

Amort.	POP	No. Alternativo	Montaje Accesorio
Pos.	Año	Aplicación	
<b>6853SE</b>	B		143155
F	99-00	GMC PICKUP 3/4 TON, K25 / K2500 4x4 PBV 9200 con Amortiguador de EO 15059138, 15155638	
F	99-05	SIERRA 1500 4x4 Exc. Estabilizador de Dirección de EO	
F	99-04	SIERRA 2500 4x4 Hasta PBV 8600#, Exc. Estabilizador de Dirección de EO	
F	01-09	SIERRA 2500 HD 4x4 PBV 9200 con Amortiguador de EO 15059138, 15155638	
F	99-05	YUKON 4x4	
F	93-98	JEEP GRAND CHEROKEE Todos	
<b>6854SE</b>	D		142718
F	00-05	FORD EXCURSION 4x4 Con Amortiguador de EO	
F	99-03	PICKUP 1 TON, F-350 / SUPERDUTY 4x4 Con Amortiguador de EO	
F	99-03	PICKUP 3/4 TON, F-250 / SUPERDUTY 4x4 Con Amortiguador de EO	
F	99-04	PICKUP, F-450 SUPERDUTY 4x4 Con Amortiguador de EO	
F	99-04	PICKUP, F-550 SUPERDUTY 4x4 Con Amortiguador de EO	
<b>6855SE</b>	C		143154
F	99-04	FORD PICKUP 1 TON, F-350 / SUPERDUTY 4x4 Kit de Reemplazo	
F	99-04	PICKUP 3/4 TON, F-250 / SUPERDUTY 4x4 Kit de Reemplazo	
<b>6856SE</b>	D		143156
F	05-07	FORD PICKUP 3/4 TON, F-250 / SUPERDUTY 4x4 Exc. Estabilizador de Dirección de EO	
F	05-06	PICKUP 3/4 TON, F-250 / SUPERDUTY Todos Exc. Estabilizador de Dirección de EO	
<b>6857SE</b>	W		143157
F	93-97	FORD PICKUP 1/2 TON, F SUPERDUTY Todos Con Amortiguador de EO	
<b>6858SE</b>	W		143161
F	95-01	FORD VAN 1/2 TON, ECONOLINE / CLUB WAGON Todos Kit de Repuesto	
F	95-02	VAN 1 TON, ECONOLINE / CLUB WAGON / SUPERDUTY Todos Kit de Repuesto	
F	95-01	VAN 3/4 TON, ECONOLINE / CLUB WAGON / SUPERDUTY Todos Kit de Repuesto	
<b>6859SE</b>	W		143166
F	94-01	DODGE PICKUP 1/2 TON, RAM 1500 4x2 Tracción trasera, GAS Estabilizador de Dirección para Suspensión con Resortes Helicoidales	
F	94-02	PICKUP 1 TON, RAM 3500 4x2 Tracción trasera, GAS Estabilizador de Dirección para Suspensión con Resortes Helicoidales	
F	94-02	PICKUP 3/4 TON, RAM 2500 4x2 Tracción trasera, GAS Estabilizador de Dirección para Suspensión con Resortes Helicoidales	
<b>6860SE</b>	W		143162
F	97-03	FORD PICKUP 1/2 TON, F-150 4x2 Tracción trasera, Coil (FrontSpringType)	
F	97-99	PICKUP 3/4 TON, F-250 / SUPERDUTY 4x2 Tracción trasera, Coil (FrontSpringType)	
<b>6861SE</b>	W		143160
F	97-02	FORD EXPEDITION 4x4, Barra de Torsion (FrontSpringType)	
F	97-03	PICKUP 1/2 TON, F-150 4x4	
F	97-99	PICKUP 3/4 TON, F-250 / SUPERDUTY 4x4, Barra de Torsion (FrontSpringType)	
<b>6862SE</b>	W		143159
F	97-98	FORD PICKUP 3/4 TON, F-250 / SUPERDUTY 4x4 PBV arriba de 8600# y HD	

Amort.	POP	No. Alternativo	Montaje Accesorio
Pos.	Año	Aplicación	
<b>6863SE</b>	W		143164
F	98	NISSAN FRONTIER 4x4	
<b>14004</b>	D		
F	73-80	VOLKSWAGEN SAFARI	
<b>14016</b>	W		140126
F	71-79	FORD BRONCO Todos	
F	67	BRONCO Todos	
F	79	PICKUP 1/2 TON, F-100 Todos Sistema Sencillo 4x4	
F	77-78	PICKUP 1/2 TON, F-100 Todos 4x4	
F	75-76	PICKUP 1/2 TON, F-100 4x4	
F	76-79	PICKUP 1/2 TON, F-150 4x4 4x4	
F	75	PICKUP 1/2 TON, F-150 Todos 4x4	
<b>14017</b>	W		142387
F	87-91	CHEVROLET BLAZER 4x4 Full Size	
F	75-86	BLAZER 4x4	
F	75-84	BLAZER 4x2 Tracción trasera	
F	73-86	PICKUP 1/2 TON, K10 Todos	
F	87	PICKUP 1/2 TON, V10 Todos	
F	77-86	PICKUP 1 TON, K30 Todos	
F	73-74	PICKUP 1 TON, K30 Todos	
F	89-91	PICKUP 1 TON, R3500 Todos	
F	87-88	PICKUP 1 TON, V30 Todos	
F	89-91	PICKUP 1 TON, V3000 / V3500 Todos	
F	73-86	PICKUP 3/4 TON, K20 Todos	
F	87	PICKUP 3/4 TON, V20 Todos	
F	73-86	SUBURBAN 1/2 TON, K10 Todos	
F	87-88	SUBURBAN 1/2 TON, R10 Todos	
F	73-86	SUBURBAN 3/4 TON, K20 Todos	
F	87-88	SUBURBAN 3/4 TON, V20 Todos	
F	89-91	SUBURBAN 3/4 TON, V2500 Todos	
F	73-91	GMC JIMMY Todos Amortiguador de reemplazo para vehículos con estabilizador de EO	
F	73-86	PICKUP 1/2 TON, K15 / K1500 Todos	
F	87	PICKUP 1/2 TON, V1500 Todos	
F	77-86	PICKUP 1 TON, K35 / K3500 Todos	
F	73-74	PICKUP 1 TON, K35 / K3500 Todos	
F	87-91	PICKUP 1 TON, V3000 / V3500 Todos	
F	73-86	PICKUP 3/4 TON, K25 / K2500 Todos	
F	87	PICKUP 3/4 TON, V2500 Todos	
F	73-86	SUBURBAN 1/2 TON, K15 / K1500 Todos	
F	87-91	SUBURBAN 1/2 TON, V1500 Todos	
F	73-86	SUBURBAN 3/4 TON, K25 / K2500 Todos	
F	87-91	SUBURBAN 3/4 TON, V2500 Todos	
<b>14019</b>	W		141264
F	92-96	CADILLAC COMMERCIAL CHASSIS 4x2 Tracción trasera	
F	77-84	COMMERCIAL CHASSIS Todos	
<b>14040</b>	B		500498
F	84-01	JEEP CHEROKEE Todos	
F	86-92	COMANCHE Todos	
<b>14071</b>	B		
F	99-04	JEEP GRAND CHEROKEE Todos Amortiguador de Dirección Sistema Sencillo	
<b>14072</b>	N		
F	08-10	FORD PICKUP 1 TON, F-350 / SUPERDUTY 4x4	
F	08-10	PICKUP 3/4 TON, F-250 / SUPERDUTY 4x4	
F	08-10	PICKUP, F-450 SUPERDUTY 4x4	
F	08-10	PICKUP, F-550 SUPERDUTY 4x4	
<b>14075</b>	N		
F	11-13	CHEVROLET PICKUP 1 TON, SILVERADO 3500 HD Todos	
F	11-13	PICKUP 3/4 TON, SILVERADO 2500 HD Todos	
F	11-13	GMC SIERRA 2500 HD Todos	
F	11-13	SIERRA 3500 HD Todos	
<b>Amortiguadores de Carga Traseros</b>			
<b>34036</b>	W		140357
F	69-84	CHEVROLET BLAZER 4x2 Tracción trasera	
F	63-86	PICKUP 1/2 TON, C10 Todos	
F	87	PICKUP 1/2 TON, R10 Todos	
F	63-86	PICKUP 1 TON, C30 Todos	
F	88-91	PICKUP 1 TON, C35/3500 Cab & Chassis	
F	87-88	PICKUP 1 TON, R30 Todos	

## Lista numérica

Amort.	POP	No. Alternativo	Montaje Accesorio
Pos.	Año	Aplicación	
<b>34036</b>	W	-continued	140357
F	89	PICKUP 1 TON, R3500 Standard Cab Pickup	
F	63-74	PICKUP 3/4 TON, C20 Todos	
F	87-88	PICKUP 3/4 TON, R20 Crew Cab Pickup	
F	89	PICKUP 3/4 TON, R2500 4x2 Tracción trasera	
F	63-67	SUBURBAN 1/2 TON, 1500 Todos	
F	63-86	SUBURBAN 1/2 TON, C10 Todos	
F	87-88	SUBURBAN 1/2 TON, R10 Todos	
F	89-91	SUBURBAN 1/2 TON, R1500 Todos	
F	65-86	SUBURBAN 3/4 TON, C20 Todos	
F	87-88	SUBURBAN 3/4 TON, R20 Todos	
F	89-91	SUBURBAN 3/4 TON, R2500 Todos	
F	63-80	VAN 1/2 TON, P SERIES Todos	
F	68-89	VAN 3/4 TON, P SERIES Todos	
F	70-84	GMC JIMMY 4x2 Tracción trasera	
F	67-86	PICKUP 1/2 TON, C15 / C1500 Todos	
F	87	PICKUP 1/2 TON, R1500 Todos	
F	91	PICKUP 1 TON, C35/3500 Cab & Chassis Eje Delantero Rígido HD	
F	88-90	PICKUP 1 TON, C35/3500 Cab & Chassis	
F	67-78	PICKUP 1 TON, C35/3500 Todos	
F	87-91	PICKUP 1 TON, R3500 Todos	
F	85-86	PICKUP 3/4 TON, C25 / C2500 Crew Cab Pickup	
F	75-86	PICKUP 3/4 TON, C25 / C2500 Cab & Chassis	
F	75-86	PICKUP 3/4 TON, C25 / C2500 Standard Cab Pickup	
F	75-83	PICKUP 3/4 TON, C25 / C2500 Crew Cab Pickup	
F	67-74	PICKUP 3/4 TON, C25 / C2500 Todos	
F	87-89	PICKUP 3/4 TON, R2500 Todos Exc. Crew Cab & Bonus Cab	
F	63-65	PICKUP 1500 SERIES Todos	
F	68-86	SUBURBAN 1/2 TON, C15 / C1500 Todos	
F	87-91	SUBURBAN 1/2 TON, R1500 Todos	
F	68-86	SUBURBAN 3/4 TON, C25 / C2500 Todos	
F	87-91	SUBURBAN 3/4 TON, R2500 Todos	
F	67-80	VAN 1/2 TON, P SERIES Todos	
F	75-90	VAN 1 TON, P SERIES Todos Exc. Chasis Motorhome	
F	74	VAN 1 TON, P SERIES Base Exc. Chasis Motorhome	
F	73	VAN 1 TON, P SERIES Todos Exc. Chasis Motorhome	
F	68-72	VAN 1 TON, P SERIES Todos	
F	68-89	VAN 3/4 TON, P SERIES Todos	
F	63-65	VAN, PB 1000 SERIES Todos	
<b>34051</b>	W		140455
F	05	CHEVROLET BLAZER Base, 4x2 Tracción trasera	
F	96-04	BLAZER LS, 4x2 Tracción trasera	
F	95-02	BLAZER LT, 4x2 Tracción trasera	
F	95-99	BLAZER Base, 4x2 Tracción trasera	
F	95-97	BLAZER Deluxe, 4x2 Tracción trasera	
F	83-94	BLAZER, S MODELS 4x2 Tracción trasera	
F	94-03	S10 LS, 4x2 Tracción trasera	
F	83-03	S10 Base, 4x2 Tracción trasera	
F	92-93	S10 EL, 4x2 Tracción trasera	
F	83-92	S10 Tahoe, 4x2 Tracción trasera	
F	88-90	S10 Durango, 4x2 Tracción trasera	
F	83-86	S10 Durango, 4x2 Tracción trasera	
F	82	S10 Base	
F	82	S10 Durango	
F	92-04	GMC JIMMY 4x2 Tracción trasera	
F	83-91	S15 JIMMY 4x2 Tracción trasera	
F	04	SONOMA / S15 Todos 4x2 Tracción trasera	
F	82-03	SONOMA / S15 4x2 Tracción trasera	
<b>34052</b>	W		140126
F	72-93	DODGE PICKUP 1/2 TON, D100 SERIES Todos	
F	72-93	PICKUP 3/4 TON, D200 SERIES Todos Exc. Paquete HD	
F	75-93	RAMCHARGER 4x2 Tracción trasera	
F	99-03	VAN 1/2 TON, A / B SERIES / RAM 109.3 (WheelBase) Exc. PBV 7000#	
F	82-98	VAN 1/2 TON, A / B SERIES / RAM 109.6 (WheelBase) Exc. PBV 7000#	
F	71-80	VAN 1/2 TON, A / B SERIES / RAM Todos	

## Amortiguadores de Carga Traseros

Amort.	POP	No. Alternativo	Montaje Accesorio
Pos.	Año	Aplicación	
<b>34052</b>	W	-continued	140126
F	99-03	VAN 1 TON, A / B SERIES / RAM Todos	
F	71-98	VAN 1 TON, A / B SERIES / RAM Todos Exc. Eje Delantero 4000#	
F	71-03	VAN 3/4 TON, A / B SERIES / RAM Todos	
F	78-80	VAN, CB300 Todos Exc. Eje Delantero 4000#	
F	74-77	VAN, CB300 Todos Hasta PBV 8300#	
F	81	PLYMOUTH TRAILDUSTER Todos	
F	75-80	TRAILDUSTER 4x2 Tracción trasera	
F	74-83	VAN 1/2 TON, PB SERIES Todos	
F	74-83	VAN 1 TON, PB SERIES Todos Exc. Eje Delantero 4000#	
F	74-83	VAN 3/4 TON, PB SERIES Todos	
<b>34057</b>	W		140780
F	80-96	FORD BRONCO Todos Con o sin Suspensión Quad detrás del Eje Delantero; Exc. Kit de Levantamiento	
F	89	BRONCO II Todos Fab. hasta 2/89; Vehículos con perno 10mm & 12mm en montaje inferior trasero	
F	84-88	BRONCO II Todos Con Perno de 10mm en Montaje Inferior Trasero	
F	80-83	PICKUP 1/2 TON, F-100 4x2 Tracción trasera	
F	80-96	PICKUP 1/2 TON, F-150 4x4 Con o sin Suspensión Quad detrás del Eje Delantero; Exc. Kit de Levantamiento	
F	80-96	PICKUP 1/2 TON, F-150 4x2 Tracción trasera	
F	80-97	PICKUP 1 TON, F-350 / SUPERDUTY 4x2 Tracción trasera	
F	80-96	PICKUP 3/4 TON, F-250 / SUPERDUTY 4x2 Tracción trasera	
F	87-89	RANGER Todos Exc. Opción High Ryder	
F	83-86	RANGER Todos	
<b>34058</b>	W		140780
F	66-77	FORD BRONCO Todos Desde Serie #830001; Exc. Kit de Levantamiento	
F	73-79	PICKUP 1/2 TON, F-100 4x2 Tracción trasera	
F	65-72	PICKUP 1/2 TON, F-100 Todos 4x2 Tracción trasera	
F	75-79	PICKUP 1/2 TON, F-150 4x2 Tracción trasera	
F	75-79	PICKUP 1 TON, F-350 / SUPERDUTY 4x2 Tracción trasera	
F	73-74	PICKUP 1 TON, F-350 / SUPERDUTY Todos 4x2 Tracción trasera; Exc. Supercab	
F	73-79	PICKUP 3/4 TON, F-250 / SUPERDUTY 4x2 Tracción trasera	
F	70-72	PICKUP 3/4 TON, F-250 / SUPERDUTY Todos 4x2 Tracción trasera	
F	77-91	VAN 1 TON, ECONOLINE / CLUB WAGON / SUPERDUTY Todos	
F	75-91	VAN 1 TON, ECONOLINE / CLUB WAGON / SUPERDUTY Todos Exc. Conversión Motorhome	
F	75-91	VAN 3/4 TON, ECONOLINE / CLUB WAGON / SUPERDUTY Todos	
<b>34073</b>	W		141041
F	92-96	CADILLAC COMMERCIAL CHASSIS 4x2 Tracción trasera	
F	77-84	COMMERCIAL CHASSIS Todos	
F	94-96	CHEVROLET IMPALA Todos	
F	83-85	IMPALA Todos	
F	82	IMPALA Sedan	
F	65-81	IMPALA Todos	
F	92-02	FORD CROWN VICTORIA Todos Exc. Sistema de Autonivelación NIVOMAT	
F	87-91	LTD / COUNTRY SEDAN / COUNTRY SQUIRE / CROWN VICTORIA Todos	
<b>34076</b>	W		140780
F	91-94	FORD EXPLORER Todos	
<b>43048</b>	W		
R	87-93	DODGE PICKUP, RAM 50 4x2 Tracción trasera	
R	83-86	PICKUP, RAM 50 Todos	
R	55	FORD F SERIES Todos F-100	
R	61-64	PICKUP 1/2 TON, F-100 Todos	

## Lista numérica

Amort.	POP	No. Alternativo	Montaje Accesorio
Pos.	Año	Aplicación	
<b>43048</b>	W	-continued	
R	61-66	PICKUP 1 TON, F-350 / SUPERDUTY Todos	
R	61-64	PICKUP 3/4 TON, F-250 / SUPERDUTY Todos	
R	68	INTERNATIONAL 908B Todos	
R	68	908C Todos	
R	68	1000B Todos	
R	68	1000C Todos	
R	68	1100B Todos Exc. Travelette c/ base de rueda de 166"	
R	68	1100C Todos Exc. Travelette c/ base de rueda de 166"	
R	68	1200B Todos Exc. Travelette c/ base de rueda de 166"	
R	68	1200C Todos Exc. Travelette c/ base de rueda de 166"	
R	68	1300B Todos Exc. Travelette c/ base de rueda de 166"	
R	68	1300C Todos Exc. Travelette c/ base de rueda de 166"	
R	68-72	M1100 / M1200 Todos	
R	69	M1400 Todos	
R	65-67	M SERIES VAN Todos	
R	72-83	JEEP CJ5 Todos Exc. Kit de Levantamiento	
R	66-71	CJ5 Todos	
R	72-75	CJ6 Todos Exc. Kit de Levantamiento	
R	66-71	CJ6 Todos	
R	76-86	CJ7 Todos Exc. Kit de Levantamiento	
R	66-74	DJ5 Todos Exc. Kit de Levantamiento	
R	66-68	DJ6 Todos	
R	57-60	FC150 Todos	
R	63-65	FC170 Todos	
R	63-66	GLADIATOR Todos Suspensión Delantero Independiente	
R	70-73	JEEPSTER Todos	
R	81-85	SCRAMBLER / CJ8 Todos	
R	67	UNIVERSAL Todos	
R	61-65	UNIVERSAL Todos	
R	86-87	MAZDA B2000 4x2 Tracción trasera	
R	87-93	B2200 4x2 Tracción trasera	
R	87-93	B2600 4x2 Tracción trasera	
R	87-90	MITSUBISHI VAN Todos	
R	98-04	NISSAN FRONTIER 4x2 Tracción trasera Exc. Desert Runner	
R	95-97	PICKUP 4x2 Tracción trasera	
R	84-95	TOYOTA PICKUP 4x2 Tracción trasera	
R	73-83	PICKUP 4x2 Tracción trasera Mojave	
R	70-72	PICKUP 4x2 Tracción trasera	
R	84-88	VAN Leaf (RearSpringType)	
R	88	VAN WAGON Leaf (FrontSpringType), Leaf (RearSpringType)	
<b>43049</b>	W		140630
R	92-96	CADILLAC COMMERCIAL CHASSIS 4x2 Tracción trasera	
R	77-84	COMMERCIAL CHASSIS Todos	
R	94-96	CHEVROLET IMPALA Todos	
R	83-85	IMPALA Todos	
R	65-82	IMPALA Sedan	
R	74-81	IMPALA Coupe	
R	73	IMPALA Hardtop	
<b>43058</b>	W		141137,140739
R	78-79	FORD BRONCO Todos Exc. Kit de Levantamiento	
R	66-77	BRONCO Todos Desde Serie #830001; Exc. Kit de Levantamiento	
R	66-69	PICKUP 1/2 TON, F-100 4x2 Tracción trasera	
R	65	PICKUP 1/2 TON, F-100 Todos 4x2 Tracción trasera	
R	75-79	PICKUP 1 TON, F-350 / SUPERDUTY Standard Cab Pickup, 4x2 Tracción trasera	
R	73-74	PICKUP 1 TON, F-350 / SUPERDUTY Todos Supercab	
R	75-79	PICKUP 3/4 TON, F-250 / SUPERDUTY Cab & Chassis, 4x2 Tracción trasera	
R	75-79	PICKUP 3/4 TON, F-250 / SUPERDUTY Extended Cab Pickup, 4x2 Tracción trasera	
R	70-74	PICKUP 3/4 TON, F-250 / SUPERDUTY 4x2 Tracción trasera	
R	65-69	PICKUP 3/4 TON, F-250 / SUPERDUTY Todos	

Lista numérica

Amort.	POP	No. Alternativo	Montaje Accesorio
Pos.	Año	Aplicación	
<b>43058</b>	W	-continued	141137,140739
R	69-74	VAN 1/2 TON, ECONOLINE / CLUB WAGON Todos	
R	68	VAN 1/2 TON, ECONOLINE / CLUB WAGON Todos A finales de 1968	
R	69-74	VAN 1 TON, ECONOLINE / CLUB WAGON / SUPERDUTY Todos	
R	68	VAN 1 TON, ECONOLINE / CLUB WAGON / SUPERDUTY Todos A finales de 1968	
R	69-74	VAN 3/4 TON, ECONOLINE / CLUB WAGON / SUPERDUTY Todos	
R	68	VAN 3/4 TON, ECONOLINE / CLUB WAGON / SUPERDUTY Todos A finales de 1968	
R	74-83	JEEP CHEROKEE Todos	
R	67	GLADIATOR Todos	
R	84-91	GRAND WAGONEER Todos	
R	74-88	J10 PICKUP Todos	
R	74-88	J20 PICKUP Todos	
R	68-73	J2500 PICKUP Todos	
R	74-83	WAGONEER Todos	
<b>43060</b>	W		140630
R	71-82	CHEVROLET IMPALA Wagon	
<b>43062</b>	W		
R	69-72	CHEVROLET BLAZER Todos 4x2 Tracción trasera; Resorte Trasero	
R	67-72	PICKUP 1/2 TON, C10 Todos Resorte Trasero	
R	67-72	PICKUP 3/4 TON, C20 Todos Resorte Trasero	
R	67	SUBURBAN 1/2 TON, 1500 Todos	
R	67-72	SUBURBAN 1/2 TON, C10 Todos	
R	68-72	SUBURBAN 3/4 TON, C20 Todos	
R	67-72	VAN 1/2 TON, P SERIES Todos	
R	70-72	GMC JIMMY 4x4	
R	67-72	PICKUP 1/2 TON, C15 / C1500 Todos	
R	67-72	PICKUP 3/4 TON, C25 / C2500 Todos	
R	68-72	SUBURBAN 1/2 TON, C15 / C1500 Todos	
R	68-72	SUBURBAN 3/4 TON, C25 / C2500 Todos	
R	68-72	VAN 1/2 TON, P SERIES Todos	
<b>43067</b>	W		
R	72-93	DODGE PICKUP 1/2 TON, D100 SERIES Todos	
R	72-93	PICKUP 1 TON, D300 SERIES Todos	
R	72-93	PICKUP 3/4 TON, D200 SERIES Todos	
R	76-93	RAMCHARGER 4x2 Tracción trasera	
R	74-75	RAMCHARGER Todos	
R	74-81	PLYMOUTH TRAILDUSTER Todos	
<b>43085</b>	W		140724
R	99-03	DODGE VAN 1/2 TON, A / B SERIES / RAM 109.3 (WheelBase) Exc. PBV 7000#	
R	81-98	VAN 1/2 TON, A / B SERIES / RAM 109.6 (WheelBase) Exc. PBV 7000#	
R	71-80	VAN 1/2 TON, A / B SERIES / RAM Todos	
R	99-03	VAN 1 TON, A / B SERIES / RAM Todos	
R	95-98	VAN 1 TON, A / B SERIES / RAM Todos Exc. Eje Delantero 4000#	
R	71-94	VAN 1 TON, A / B SERIES / RAM Todos	
R	71-03	VAN 3/4 TON, A / B SERIES / RAM Todos	
R	74-80	VAN, CB300 Todos	
R	74-83	PLYMOUTH VAN 1/2 TON, PB SERIES Todos	
R	74-83	VAN 1 TON, PB SERIES Todos	
R	74-83	VAN 3/4 TON, PB SERIES Todos	
<b>43093</b>	W		141058
R	69-72	CHEVROLET BLAZER Todos 4x2 Tracción trasera; Resorte Trasero de Hojas Múltiples	
R	63-72	PICKUP 1/2 TON, C10 Todos Resorte Trasero de Hojas Múltiples	
R	67-72	PICKUP 1 TON, C30 Todos Exc. Eje Trasero 11,000#	
R	67-72	PICKUP 3/4 TON, C20 Todos Resorte Trasero de Hojas Múltiples	
R	63-66	PICKUP 3/4 TON, C20 Todos	
R	63-66	SUBURBAN 1/2 TON, 1500 Todos	
R	67-77	VAN 1/2 TON, G / EXPRESS Todos	
R	63-66	VAN 1/2 TON, P SERIES Todos	

Amortiguadores de Carga Traseros

Amort.	POP	No. Alternativo	Montaje Accesorio
Pos.	Año	Aplicación	
<b>43093</b>	W	-continued	141058
R	76-77	VAN 1 TON, G / EXPRESS Todos	
R	75	VAN 1 TON, G / EXPRESS 110.0 (WheelBase)	
R	75	VAN 1 TON, G / EXPRESS 125.0 (WheelBase)	
R	71-74	VAN 1 TON, G / EXPRESS Todos	
R	67-77	VAN 3/4 TON, G / EXPRESS Todos	
R	68-72	VAN 3/4 TON, P SERIES Todos	
R	70-72	GMC JIMMY 4x2 Tracción trasera	
R	67-72	PICKUP 1 TON, C35/3500 Todos Exc. Eje Trasero 11,000#	
R	63-65	PICKUP 1500 SERIES Todos	
R	67-77	VAN 1/2 TON, G / SAVANNA Todos	
R	67	VAN 1/2 TON, P SERIES Todos	
R	76-77	VAN 1 TON, G / SAVANNA Todos	
R	75	VAN 1 TON, G / SAVANNA 110.0 (WheelBase)	
R	75	VAN 1 TON, G / SAVANNA 125.0 (WheelBase)	
R	71-74	VAN 1 TON, G / SAVANNA Todos Exc. Base de rueda de 146"	
R	68-72	VAN 1 TON, P SERIES Todos Exc. Eje Trasero 11,000#	
R	67-77	VAN 3/4 TON, G / SAVANNA Todos	
R	68-72	VAN 3/4 TON, P SERIES Todos	
R	63-65	VAN, PB 1000 SERIES Todos	
<b>43096</b>	W		
R	70-74	DODGE CHALLENGER Todos	
R	66-76	CHARGER Todos	
<b>43099</b>	W		140126
R	66	FORD BRONCO Todos Toda la serie #830000	
R	75-79	PICKUP 1/2 TON, F-100 4x2 Tracción trasera	
R	70-74	PICKUP 1/2 TON, F-100 Todos Exc. Supercab	
R	75-79	PICKUP 1/2 TON, F-150 Standard Cab Pickup, 4x2 Tracción trasera	
R	75-79	PICKUP 1 TON, F-350 / SUPERDUTY Cab & Chassis, 4x2 Tracción trasera	
R	75-79	PICKUP 1 TON, F-350 / SUPERDUTY Extended Cab Pickup, 4x2 Tracción trasera	
R	74	PICKUP 1 TON, F-350 / SUPERDUTY Todos 4x2 Tracción trasera; Exc. Supercab	
R	71-79	PICKUP 3/4 TON, F-250 / SUPERDUTY Standard Cab Pickup, 4x2 Tracción trasera	
R	70	PICKUP 3/4 TON, F-250 / SUPERDUTY Standard Cab Pickup, 4x2 Tracción trasera Exc. Supercab	
R	75-91	VAN 1/2 TON, ECONOLINE / CLUB WAGON Todos	
<b>43107</b>	W		
F	87-91	CHEVROLET BLAZER 4x4 Automóvil Grande; Exc. Suspensión Quad y Kit de Levantamiento	
F	75-86	BLAZER 4x4 Exc. Suspensión Quad y Kit de Levantamiento	
F	73-74	BLAZER 4x4 Exc. Kit de Levantamiento	
F	69-72	BLAZER 4x4	
F	81-86	PICKUP 1/2 TON, K10 Todos Suspensión Estándar; Exc. Kit de Levantamiento	
F	69-80	PICKUP 1/2 TON, K10 Todos Exc. Kit de Levantamiento	
F	87	PICKUP 1/2 TON, V10 Todos Exc. Suspensión Quad y Kit de Levantamiento	
F	81-86	PICKUP 3/4 TON, K20 Todos Suspensión Estándar; Exc. Kit de Levantamiento	
F	75-80	PICKUP 3/4 TON, K20 Todos Exc. Kit de Levantamiento	
F	73-74	PICKUP 3/4 TON, K20 Todos Exc. Suspensión Quad y Kit de Levantamiento	
F	87	PICKUP 3/4 TON, V20 Todos Exc. Suspensión Quad y Kit de Levantamiento	
F	81-86	SUBURBAN 1/2 TON, K10 Todos Suspensión Estándar; Exc. Kit de Levantamiento	
F	69-80	SUBURBAN 1/2 TON, K10 Todos Exc. Kit de Levantamiento	
F	87-88	SUBURBAN 1/2 TON, R10 Todos Exc. Suspensión Quad y Kit de Levantamiento	

Lista numérica

Amort.	POP	No. Alternativo	Montaje Accesorio
Pos.	Año	Aplicación	
<b>43107</b>	W	-continued	
F	70-91	GMC JIMMY 4x4 Exc. Suspensión Quad y Kit de Levantamiento	
F	73-86	PICKUP 1/2 TON, K15 / K1500 Todos Exc. Suspensión Quad y Kit de Levantamiento	
F	69-72	PICKUP 1/2 TON, K15 / K1500 Todos	
F	87	PICKUP 1/2 TON, V1500 Todos Exc. Kit de Levantamiento	
F	69-86	PICKUP 3/4 TON, K25 / K2500 Todos Exc. Suspensión Quad y Kit de Levantamiento	
F	87	PICKUP 3/4 TON, V2500 Todos Exc. Kit de Levantamiento	
F	69-86	SUBURBAN 1/2 TON, K15 / K1500 Todos Exc. Suspensión Quad y Kit de Levantamiento	
F	87-91	SUBURBAN 1/2 TON, V1500 Todos Exc. Kit de Levantamiento	
F	69-86	SUBURBAN 3/4 TON, K25 / K2500 Todos Exc. Suspensión Quad y Kit de Levantamiento	
F	87-91	SUBURBAN 3/4 TON, V2500 Todos Exc. Kit de Levantamiento	
<b>43111</b>	W		140702
R	87-91	CHEVROLET BLAZER Todos Automóvil Grande; Exc. Suspensión Quad y Kit de Levantamiento	
R	73-86	BLAZER Todos Exc. Kit de Levantamiento	
R	73-86	PICKUP 1/2 TON, C10 Todos	
R	73-86	PICKUP 1/2 TON, K10 Todos Exc. Suspensión Quad y Kit de Levantamiento	
R	87	PICKUP 1/2 TON, R10 Todos	
R	87	PICKUP 1/2 TON, V10 Todos Exc. Suspensión Quad y Kit de Levantamiento	
R	73-74	PICKUP 3/4 TON, C20 Todos Standard Cab Pickup	
R	73-86	PICKUP 3/4 TON, K20 Todos Exc. Suspensión Quad y Kit de Levantamiento	
R	87	PICKUP 3/4 TON, R20 Standard Cab Pickup	
R	87	PICKUP 3/4 TON, V20 Todos Exc. Suspensión Quad y Kit de Levantamiento	
R	73-86	SUBURBAN 1/2 TON, C10 Todos	
R	73-86	SUBURBAN 1/2 TON, K10 Todos Exc. Suspensión Quad y Kit de Levantamiento	
R	87-88	SUBURBAN 1/2 TON, R10 Todos	
R	89-91	SUBURBAN 1/2 TON, R1500 Todos	
R	89-91	SUBURBAN 1/2 TON, V1500 Todos Exc. Suspensión Quad y Kit de Levantamiento	
R	73-86	SUBURBAN 3/4 TON, C20 Todos	
R	73-86	SUBURBAN 3/4 TON, K20 Todos Exc. Suspensión Quad y Kit de Levantamiento	
R	87-88	SUBURBAN 3/4 TON, R20 Todos	
R	89-91	SUBURBAN 3/4 TON, R2500 Todos	
R	87-88	SUBURBAN 3/4 TON, V20 Todos Exc. Suspensión Quad y Kit de Levantamiento	
R	89-91	SUBURBAN 3/4 TON, V2500 Todos Exc. Suspensión Quad y Kit de Levantamiento	
R	73	VAN 1/2 TON, P SERIES Todos	
R	73-78	VAN 3/4 TON, P SERIES Todos	
R	73-91	GMC JIMMY Todos Exc. Kit de Levantamiento	
R	73-86	PICKUP 1/2 TON, C15 / C1500 Todos	
R	75-86	PICKUP 1/2 TON, K15 / K1500 Todos Exc. Suspensión Quad y Kit de Levantamiento	
R	87	PICKUP 1/2 TON, R1500 Todos	
R	87	PICKUP 1/2 TON, V1500 Todos Suspensión Quad Exc. Kit de Levantamiento	
R	75-86	PICKUP 3/4 TON, C25 / C2500 Cab & Chassis	
R	75-86	PICKUP 3/4 TON, C25 / C2500 Standard Cab Pickup	
R	73-74	PICKUP 3/4 TON, C25 / C2500 Todos	
R	86	PICKUP 3/4 TON, K25 / K2500 Todos Exc. Kit de Levantamiento	
R	73-85	PICKUP 3/4 TON, K25 / K2500 Todos Exc. Suspensión Quad y Kit de Levantamiento	

Lista numérica

Lista numérica

Amort.	POP	No. Alternativo	Montaje Accesorio
Pos.	Año	Aplicación	
<b>43111</b>	W	-continued	<b>140702</b>
R 88-89	PICKUP 3/4 TON, R2500	Todos Exc. Crew Cab & Bonus Cab	
R 87	PICKUP 3/4 TON, R2500	Cab & Chassis Exc. Crew Cab & Bonus Cab	
R 87	PICKUP 3/4 TON, R2500	Standard Cab Pickup Exc. Crew Cab & Bonus Cab	
R 87	PICKUP 3/4 TON, V2500	Todos Exc. Kit de Levantamiento	
R 73-86	SUBURBAN 1/2 TON, C15 / C1500	Todos	
R 85-86	SUBURBAN 1/2 TON, K15 / K1500	Todos Exc. Suspensión Quad y Kit de Levantamiento	
R 84	SUBURBAN 1/2 TON, K15 / K1500	Todos Exc. Kit de Levantamiento	
R 73-83	SUBURBAN 1/2 TON, K15 / K1500	Todos Exc. Suspensión Quad y Kit de Levantamiento	
R 87-91	SUBURBAN 1/2 TON, R1500	Todos	
R 87-91	SUBURBAN 1/2 TON, V1500	Todos Exc. Kit de Levantamiento	
R 73-86	SUBURBAN 3/4 TON, C25 / C2500	Todos	
R 73-86	SUBURBAN 3/4 TON, K25 / K2500	Todos Exc. Suspensión Quad y Kit de Levantamiento	
R 87-91	SUBURBAN 3/4 TON, R2500	Todos	
R 87-91	SUBURBAN 3/4 TON, V2500	Todos Exc. Kit de Levantamiento	
R 73	VAN 1/2 TON, P SERIES	Todos	
R 73-78	VAN 3/4 TON, P SERIES	Todos	
<b>43138</b>	W		<b>140873</b>
R 77-78	<b>DODGE CHARGER</b> Todos		
<b>43140</b>	W		<b>141150</b>
R 92-02	<b>FORD CROWN VICTORIA</b> Todos		
R 87-91	LTD / COUNTRY SEDAN / COUNTRY SQUIRE / CROWN VICTORIA Todos		
<b>43142</b>	W		
R 80-96	<b>FORD BRONCO</b> Todos Exc. Kit de Levantamiento		
R 80-83	PICKUP 1/2 TON, F-100 4x2 Tracción trasera		
R 80-84	PICKUP 1/2 TON, F-150 4x2 Tracción trasera		
<b>43161</b>	W		
R 90-05	<b>CHEVROLET ASTRO</b> Todos		
R 85-89	ASTRO 4x2 Tracción trasera		
R 90-05	<b>GMC SAFARI</b> Todos		
R 85-89	SAFARI 4x2 Tracción trasera		
<b>43162</b>	W		
R 05	<b>CHEVROLET BLAZER</b> Base, 4x4		
R 05	BLAZER Base, 4x2 Tracción trasera		
R 96-04	BLAZER LS, 4x4		
R 96-04	BLAZER LS, 4x2 Tracción trasera		
R 95-02	BLAZER LT, 4x2 Tracción trasera		
R 95-01	BLAZER LT, 4x4		
R 95-99	BLAZER Base, 4x4		
R 95-99	BLAZER Base, 4x2 Tracción trasera		
R 95-97	BLAZER Deluxe, 4x2 Tracción trasera		
R 83-94	BLAZER, S MODELS Todos		
R 99-04	S10 LS, 4x4		
R 99-03	S10 Base, 4x4		
R 99-03	S10 Base, 4x2 Tracción trasera		
R 99-03	S10 LS, 4x2 Tracción trasera		
R 94-98	S10 LS		
R 82-98	S10 Base		
R 92-93	S10 EL		
R 83-92	S10 Tahoe		
R 88-90	S10 Durango		
R 82-86	S10 Durango		
R 05	<b>GMC JIMMY</b> 4x4		
R 92-04	JIMMY Todos		
R 83-91	S15 JIMMY Todos		
R 82-04	SONOMA / S15 Todos		
R 91	SYCLONE AWD		
R 92-93	TYPHOON Todos		
<b>43163</b>	W		
R 88-99	<b>CHEVROLET PICKUP</b> 1/2 TON, C15 / C1500 Todos		
R 88-99	PICKUP 1/2 TON, K15 / K1500 Todos		
R 01-03	PICKUP 1 TON, C35/3500 HD Eje Delantero Rígido HD		
R 91-00	PICKUP 1 TON, C35/3500 Todos Eje Delantero Rígido HD		

Amort.	POP	No. Alternativo	Montaje Accesorio
Pos.	Año	Aplicación	
<b>43163</b>	W	-continued	
R 88-90	PICKUP 1 TON, C35/3500 Extended Cab Pickup Eje Delantero Rígido HD		
R 88-90	PICKUP 1 TON, C35/3500 Standard Cab Pickup Eje Delantero Rígido HD		
R 88-00	PICKUP 1 TON, K35 / K3500 Todos		
R 88-00	PICKUP 3/4 TON, C25 / C2500 Todos		
R 88-00	PICKUP 3/4 TON, K25 / K2500 Todos		
R 01-02	<b>GMC C3500</b>		
R 88-99	PICKUP 1/2 TON, C15 / C1500 Todos		
R 88-99	PICKUP 1/2 TON, K15 / K1500 Todos		
R 91-00	PICKUP 1 TON, C35/3500 Todos Eje Delantero Rígido HD		
R 88-90	PICKUP 1 TON, C35/3500 Extended Cab Pickup Eje Delantero Rígido HD		
R 88-90	PICKUP 1 TON, C35/3500 Standard Cab Pickup Eje Delantero Rígido HD		
R 88-00	PICKUP 1 TON, K35 / K3500 Todos		
R 88-00	PICKUP 3/4 TON, C25 / C2500 Todos		
R 88-00	PICKUP 3/4 TON, K25 / K2500 Todos		
<b>43165</b>	W		
R 89	<b>FORD BRONCO II</b> Todos Fab. hasta 2/89; Vehículos con perno 10mm & 12mm en montaje inferior trasero		
R 84-88	BRONCO II Todos Con Perno de 10mm en Montaje Inferior Trasero		
R 89	RANGER 4x2 Tracción trasera Fab. hasta 2/89; Vehículos con perno 10mm & 12mm en montaje inferior trasero		
R 83-88	RANGER 4x2 Tracción trasera		
<b>43167</b>	W		
R 85-96	<b>FORD PICKUP</b> 1/2 TON, F-150 4x2 Tracción trasera		
R 80-97	PICKUP 1 TON, F-350 / SUPERDUTY 4x2 Tracción trasera Exc. Doble Rodada Trasera		
R 97	PICKUP 3/4 TON, F-250 / SUPERDUTY 4x2 Tracción trasera PBV arriba de 8500#		
R 80-96	PICKUP 3/4 TON, F-250 / SUPERDUTY 4x2 Tracción trasera		
R 06-11	RANGER 4x2 Tracción trasera, Coil (FrontSpringType)		
R 90-05	RANGER 4x2 Tracción trasera		
<b>43171</b>	W		<b>140719</b>
R 95-01	<b>FORD EXPLORER</b> Todos Exc. Suspensión Electrónica Ajustable		
R 01-05	EXPLORER SPORT TRAC Todos		
<b>43172</b>	W		<b>140719</b>
R 91-94	<b>FORD EXPLORER</b> Todos		
<b>43180</b>	W		
R 99-00	<b>CADILLAC ESCALADE</b> Todos		
R 92-94	<b>CHEVROLET BLAZER</b> 4x4 Automóvil Grande		
R 92-99	SUBURBAN 1/2 TON, C15 / C1500 Todos		
R 92-99	SUBURBAN 1/2 TON, K15 / K1500 Todos		
R 92-99	SUBURBAN 3/4 TON, C25 / C2500 Todos		
R 92-99	SUBURBAN 3/4 TON, K25 / K2500 Todos		
R 95-00	TAHOE Todos Old Body Style		
R 96-11	VAN 1/2 TON, G / EXPRESS Todos		
R 96-02	VAN 1 TON, G / EXPRESS Todos		
R 96-02	VAN 3/4 TON, G / EXPRESS Todos Exc. PBV 8600 #		
R 92-99	<b>GMC SUBURBAN</b> 1/2 TON, C15 / C1500 Todos		
R 92-99	SUBURBAN 1/2 TON, K15 / K1500 Todos		
R 92-99	SUBURBAN 3/4 TON, C25 / C2500 Todos		
R 92-99	SUBURBAN 3/4 TON, K25 / K2500 Todos		
R 96-11	VAN 1/2 TON, G / SAVANNA Todos		
R 96-02	VAN 1 TON, G / SAVANNA Todos		
R 96-02	VAN 3/4 TON, G / SAVANNA Todos Exc. PBV 8600 #		
R 92-99	YUKON Todos		
<b>43181</b>	W		
R 03-07	<b>CHEVROLET CHEYENNE</b>		

Amort.	POP	No. Alternativo	Montaje Accesorio
Pos.	Año	Aplicación	
<b>43181</b>	W	-continued	
R 07	PICKUP 1/2 TON, SILVERADO 1500 Classic Hybrid, 4x2 Tracción trasera Exc. Suspensión Electrónica Ajustable		
R 07	PICKUP 1/2 TON, SILVERADO 1500 Classic LS, 4x2 Tracción trasera Exc. Suspensión Electrónica Ajustable		
R 07	PICKUP 1/2 TON, SILVERADO 1500 Classic LT, 4x2 Tracción trasera Exc. Suspensión Electrónica Ajustable		
R 07	PICKUP 1/2 TON, SILVERADO 1500 Classic SS, 4x2 Tracción trasera Exc. Suspensión Electrónica Ajustable		
R 07	PICKUP 1/2 TON, SILVERADO 1500 Classic WT, 4x2 Tracción trasera Exc. Suspensión Electrónica Ajustable		
R 99-06	PICKUP 1/2 TON, SILVERADO 1500 4x2 Tracción trasera Exc. Suspensión Electrónica Ajustable		
R 94-01	<b>DODGE PICKUP</b> 1/2 TON, RAM 1500 Todos		
R 94-02	PICKUP 1 TON, RAM 3500 4x2 Tracción trasera Exc. Eje Delantero Rígido		
R 94-02	PICKUP 3/4 TON, RAM 2500 4x2 Tracción trasera		
R 07	<b>GMC SIERRA</b> 1500 Classic Hybrid, 4x2 Tracción trasera Exc. Suspensión Electrónica Ajustable		
R 07	SIERRA 1500 Classic SL, 4x2 Tracción trasera Exc. Suspensión Electrónica Ajustable		
R 07	SIERRA 1500 Classic SLE, 4x2 Tracción trasera Exc. Suspensión Electrónica Ajustable		
R 07	SIERRA 1500 Classic SLT, 4x2 Tracción trasera Exc. Suspensión Electrónica Ajustable		
R 07	SIERRA 1500 Classic WT, 4x2 Tracción trasera Exc. Suspensión Electrónica Ajustable		
R 99-06	SIERRA 1500 4x2 Tracción trasera Exc. Suspensión Electrónica Ajustable		
<b>43182</b>	N		
R 00-06	<b>CHEVROLET SUBURBAN</b> 1/2 TON, 1500 Todos Exc. Suspensión Z55 Auto Ride		
R 00-06	TAHOE Todos Exc. Suspensión Z55 Auto Ride		
R 00-06	<b>GMC YUKON</b> Todos Exc. Suspensión Z55 Auto Ride		
<b>43183</b>	N		
R 04-08	<b>FORD PICKUP</b> 1/2 TON, F-150 4x2 Tracción trasera		
<b>43184</b>	N		
R 04-08	<b>FORD PICKUP</b> 1/2 TON, F-150 4x4		
R 83-11	RANGER 4x4		
<b>43185</b>	N		
R 83-11	<b>FORD RANGER</b> 4x4		
R 94-08	<b>MAZDA B3000</b> Todos		
R 94-08	B4000 Todos		
<b>Amortiguadores Guardian Hidráulicos</b>			
<b>42094</b>	A		<b>141229</b>
R 73-80	<b>VOLKSWAGEN SAFARI</b>		
<b>42161</b>	A		<b>140524</b>
F 73-80	<b>VOLKSWAGEN SAFARI</b>		
<b>42446</b>	D		
F 75-76	<b>CHEVROLET IMPALA</b>		
F 65-72	IMPALA		
<b>42514</b>	W		
R 76	<b>CHEVROLET IMPALA</b>		
R 65-72	IMPALA		
<b>42952</b>	C		
F 65-97	<b>FORD F-350 PICKUP</b>		
<b>42957</b>	W		
F 70-72	<b>DODGE D100 PICKUP</b>		
R 70-72	D100 PICKUP		
F 80-83	RAMCHARGER		
F 89-90	W250		



## Lista numérica

Amort.	POP	No. Alternativo	Montaje Accesorio
Pos.	Año	Aplicación	
42957	W	-continued	
F	85-87	W250	
42958	B		
R	87	CHEVROLET C10	
R	79-86	C30	
R	89-90	P30	
R	79-86	PICKUP 1/2 TON, C10 Todos	
R	89-91	PICKUP 1 TON, C35/3500 Todos	
R	84-86	FORD F-150	
R	88-90	GMC C1500	
R	80-85	C1500	
R	87-91	C2500	
R	80-87	C3500	
R	88-91	PICKUP 1 TON, C35/3500 Todos	
42959	W		
R	79	FORD F-150	
42960	D		
R	73-74	DODGE D100 PICKUP	
R	88-90	D150	
R	82	D150	
R	80	D150	
R	89-90	D250	
R	89-90	D350	
R	81-87	D350	
R	80-94	RAMCHARGER	
42961	C	140702	
F	87	CHEVROLET C10	
F	79-87	C30	
F	88-91	C2500	
F	89-91	C3500	
F	89-90	P30	
F	79-86	PICKUP 1/2 TON, C10 Todos	
F	88-90	GMC C1500	
F	80-86	C1500	
F	87-91	C2500	
F	81-91	C3500	
42962	W	140126	
F	73-74	DODGE D100 PICKUP	
F	88-90	D150	
F	82-83	D150	
F	80	D150	
F	89-90	D250	
F	94	RAMCHARGER	
F	80-90	RAMCHARGER	
42963	D		
F	80-90	DODGE D350	
F	84-94	RAMCHARGER	
42964	W		
R	75-78	FORD F-100	
R	65-74	F-100 PICKUP	
R	67-78	F-350 PICKUP	
42965	W		
F	85-91	FORD B200	
F	75-78	F-100	
F	65-74	F-100 PICKUP	
F	79	F-150	
F	67-79	F-350 PICKUP	
42966	D		
R	82-85	FORD B150	
R	97	BRONCO	
R	84-97	F-150	
R	86-90	F-200	
42967	C		
F	82-85	FORD B150	
F	92	B200	
F	97	BRONCO	
F	84-97	F-150	
F	86-90	F-200	
F	80-97	F-350 PICKUP	
42968	C		
R	90-94	CHEVROLET S10 BLAZER	
42969	C		
F	90-94	CHEVROLET S10 BLAZER	
42970	B		
R	65-93	NISSAN PICKUP	
42971	W		
F	79-81	FORD B100	
F	73-74	B100	
F	75-78	B150	
42972	A	140857	
F	65-04	NISSAN PICKUP	

Amort.	POP	No. Alternativo	Montaje Accesorio
Pos.	Año	Aplicación	
42973	A		
F	68-75	JEEP CJ7	
F	76-86	WAGONEER	
R	05-08	NISSAN PICKUP	
R	95-04	PICKUP 4x2 Tracción trasera	
R	84-94	PICKUP	
<b>Amortiguadores de Aire HiJackers</b>			
49106	W	141099	
R	70-74	DODGE CHALLENGER Todos	
R	66-76	CHARGER Todos	
49107	W	141099	
R	69-72	CHEVROLET BLAZER Todos Resorte Trasero	
R	67-72	PICKUP 1/2 TON, C10 Todos Resorte Trasero	
R	67-72	PICKUP 3/4 TON, C20 Todos Resorte Trasero	
R	67	SUBURBAN 1/2 TON, 1500 Todos Resorte Trasero	
R	68-72	SUBURBAN 1/2 TON, C10 Todos	
R	68-72	SUBURBAN 3/4 TON, C20 Todos	
R	67-72	VAN 1/2 TON, P SERIES Todos	
R	70-72	GMC JIMMY 4x4	
R	67-72	PICKUP 1/2 TON, C15 / C1500 Todos Resorte Trasero	
R	67-72	PICKUP 3/4 TON, C25 / C2500 Todos Resorte Trasero	
R	68-72	SUBURBAN 1/2 TON, C15 / C1500 Todos Resorte Trasero	
R	68-72	SUBURBAN 3/4 TON, C25 / C2500 Todos	
R	68-72	VAN 1/2 TON, P SERIES Todos Resorte Trasero	
49110	W	140377,141099	
R	51-61	PLYMOUTH SUBURBAN Todos	
49127	W	140739,141137,141000	
R	78-79	FORD BRONCO Todos Exc. Kit de Levantamiento	
R	67-77	BRONCO Todos Desde Serie #830001; Exc. Kit de Levantamiento	
R	69	PICKUP 1/2 TON, F-100 4x2 Tracción trasera 4x2 Tracción trasera	
R	65-68	PICKUP 1/2 TON, F-100 Todos 4x2 Tracción trasera	
R	75-79	PICKUP 1 TON, F-350 / SUPERDUTY Standard Cab Pickup, 4x2 Tracción trasera	
R	74	PICKUP 1 TON, F-350 / SUPERDUTY Standard Cab Pickup	
R	73	PICKUP 1 TON, F-350 / SUPERDUTY Standard Cab Pickup, 4x2 Tracción trasera	
R	75-79	PICKUP 3/4 TON, F-250 / SUPERDUTY Cab & Chassis, 4x2 Tracción trasera	
R	75-79	PICKUP 3/4 TON, F-250 / SUPERDUTY Extended Cab Pickup, 4x2 Tracción trasera	
R	65-69	PICKUP 3/4 TON, F-250 / SUPERDUTY Todos 4x2 Tracción trasera; Supercab	
R	69-74	VAN 1/2 TON, ECONOLINE / CLUB WAGON Todos	
R	68	VAN 1/2 TON, ECONOLINE / CLUB WAGON Todos A finales de 1968	
R	69-74	VAN 1 TON, ECONOLINE / CLUB WAGON / SUPERDUTY Todos	
R	68	VAN 1 TON, ECONOLINE / CLUB WAGON / SUPERDUTY Todos A finales de 1968	
R	69-74	VAN 3/4 TON, ECONOLINE / CLUB WAGON / SUPERDUTY Todos	
R	68	VAN 3/4 TON, ECONOLINE / CLUB WAGON / SUPERDUTY Todos A finales de 1968	
R	76-83	JEEP CHEROKEE Todos	
R	67	GLADIATOR Todos	
R	84-91	GRAND WAGONEER Todos	
R	74-88	J10 PICKUP Todos	
R	74-88	J20 PICKUP Todos	
R	68-73	J2500 PICKUP Todos	
R	76-83	WAGONEER Todos	
49131	W	140630,141099	
R	92-96	CADILLAC COMMERCIAL CHASSIS 4x2 Tracción trasera	
R	77-84	COMMERCIAL CHASSIS Todos	
R	94-96	CHEVROLET IMPALA Todos	
R	83-85	IMPALA Todos	
R	82	IMPALA Sedan	

## Lista numérica

Amort.	POP	No. Alternativo	Montaje Accesorio
Pos.	Año	Aplicación	
49131	W	-continued 140630,141099	
R	74-81	IMPALA Coupe Exc. Wagon	
R	73-81	IMPALA Sedan Exc. Wagon	
R	73	IMPALA Hardtop Exc. Wagon	
R	70-72	IMPALA Sedan	
R	65-69	IMPALA Todos	
49149	W	141099	
R	72-93	DODGE PICKUP 1/2 TON, D100 SERIES Todos	
R	72-93	PICKUP 1 TON, D300 SERIES Todos	
R	82-93	PICKUP 3/4 TON, D200 SERIES Todos	
R	81	PICKUP 3/4 TON, D200 SERIES Todos Exc. Paquete HD	
R	72-80	PICKUP 3/4 TON, D200 SERIES Todos	
R	76-93	RAMCHARGER 4x2 Tracción trasera	
R	74-75	RAMCHARGER Todos	
R	74-81	PLYMOUTH TRAILDUSTER Todos	
49151	W	141099	
R	73-83	TOYOTA PICKUP 4x2 Tracción trasera Mojave	
R	70-72	PICKUP 4x2 Tracción trasera	
49152	W	140630,141099	
R	71-82	CHEVROLET IMPALA Wagon	
49155	W	140702,141099	
R	87-91	CHEVROLET BLAZER Todos Automóvil Grande; Exc. Suspensión Quad y Kit de Levantamiento	
R	73-86	BLAZER Todos Exc. Kit de Levantamiento	
R	73-86	PICKUP 1/2 TON, C10 Todos	
R	81-86	PICKUP 1/2 TON, K10 Todos Suspensión Estándar; Exc. Kit de Levantamiento	
R	73-80	PICKUP 1/2 TON, K10 Todos Exc. Kit de Levantamiento	
R	87	PICKUP 1/2 TON, R10 Todos	
R	87	PICKUP 1/2 TON, V10 Todos	
R	73-74	PICKUP 3/4 TON, C20 Todos Standard Cab Pickup	
R	81-86	PICKUP 3/4 TON, K20 Todos Suspensión Estándar; Exc. Kit de Levantamiento	
R	73-80	PICKUP 3/4 TON, K20 Todos Exc. Kit de Levantamiento	
R	87	PICKUP 3/4 TON, R20 Standard Cab Pickup	
R	87	PICKUP 3/4 TON, V20 Todos	
R	73-86	SUBURBAN 1/2 TON, C10 Todos	
R	81-86	SUBURBAN 1/2 TON, K10 Todos Suspensión Estándar; Exc. Kit de Levantamiento	
R	73-80	SUBURBAN 1/2 TON, K10 Todos Exc. Kit de Levantamiento	
R	87-88	SUBURBAN 1/2 TON, R10 Todos	
R	89-91	SUBURBAN 1/2 TON, R1500 Todos	
R	89-91	SUBURBAN 1/2 TON, V1500 Todos	
R	73-86	SUBURBAN 3/4 TON, C20 Todos	
R	81-86	SUBURBAN 3/4 TON, K20 Todos Suspensión Estándar; Exc. Kit de Levantamiento	
R	73-80	SUBURBAN 3/4 TON, K20 Todos Exc. Kit de Levantamiento	
R	87-88	SUBURBAN 3/4 TON, R20 Todos	
R	89-91	SUBURBAN 3/4 TON, R2500 Todos	
R	87-88	SUBURBAN 3/4 TON, V20 Todos	
R	89-91	SUBURBAN 3/4 TON, V2500 Todos	
R	73	VAN 1/2 TON, P SERIES Todos	
R	73-78	VAN 3/4 TON, P SERIES Todos	
R	73-91	GMC JIMMY Todos Exc. Kit de Levantamiento	
R	73-86	PICKUP 1/2 TON, C15 / C1500 Todos	
R	73-86	PICKUP 1/2 TON, K15 / K1500 Todos Exc. Suspensión Quad y Kit de Levantamiento	
R	87	PICKUP 1/2 TON, R1500 Todos	
R	87	PICKUP 1/2 TON, V1500 Todos Suspensión Quad Exc. Kit de Levantamiento	
R	75-86	PICKUP 3/4 TON, C25 / C2500 Cab & Chassis	
R	75-86	PICKUP 3/4 TON, C25 / C2500 Standard Cab Pickup	
R	73-74	PICKUP 3/4 TON, C25 / C2500 Todos	
R	73-86	PICKUP 3/4 TON, K25 / K2500 Todos Exc. Suspensión Quad y Kit de Levantamiento	

## Lista numérica

Amort.	POP	No. Alternativo	Montaje Accesorio
Pos.	Año	Aplicación	
<b>49155</b>	W	-continued	<b>140702,141099</b>
R	88-89	PICKUP 3/4 TON, R2500 Todos	Exc. Crew Cab & Bonus Cab
R	87	PICKUP 3/4 TON, R2500 Cab & Chassis	Exc. Crew Cab & Bonus Cab
R	87	PICKUP 3/4 TON, R2500 Standard Cab	Pickup Exc. Crew Cab & Bonus Cab
R	87	PICKUP 3/4 TON, V2500 Todos	Exc. Kit de Levantamiento
R	73-86	SUBURBAN 1/2 TON, C15 / C1500	Todos
R	73-86	SUBURBAN 1/2 TON, K15 / K1500	Todos
R	87-91	SUBURBAN 1/2 TON, R1500 Todos	Exc. Suspensión Quad y Kit de Levantamiento
R	87-91	SUBURBAN 1/2 TON, V1500 Todos	Exc. Kit de Levantamiento
R	73-86	SUBURBAN 3/4 TON, C25 / C2500	Todos
R	73-86	SUBURBAN 3/4 TON, K25 / K2500	Todos
R	87-91	SUBURBAN 3/4 TON, R2500 Todos	Exc. Suspensión Quad y Kit de Levantamiento
R	87-91	SUBURBAN 3/4 TON, V2500 Todos	Exc. Kit de Levantamiento
R	73	VAN 1/2 TON, P SERIES Todos	
R	73-78	VAN 3/4 TON, P SERIES Todos	
<b>49162</b>	W		<b>141058,141099</b>
R	69-72	<b>CHEVROLET</b> BLAZER Todos	Resorte Trasero de Hojas Múltiples
R	63-72	PICKUP 1/2 TON, C10 Todos	Resorte Trasero de Hojas Múltiples
R	67-72	PICKUP 1 TON, C30 Todos	Exc. Eje Trasero 11,000#
R	67-72	PICKUP 3/4 TON, C20 Todos	Resorte Trasero de Hojas Múltiples
R	63-66	PICKUP 3/4 TON, C20 Todos	
R	63-66	SUBURBAN 1/2 TON, 1500 Todos	
R	67-77	VAN 1/2 TON, G / EXPRESS Todos	
R	63-66	VAN 1/2 TON, P SERIES Todos	
R	76-77	VAN 1 TON, G / EXPRESS Todos	
R	75	VAN 1 TON, G / EXPRESS 110.0	(WheelBase)
R	75	VAN 1 TON, G / EXPRESS 125.0	(WheelBase)
R	71-74	VAN 1 TON, G / EXPRESS Todos	
R	67-77	VAN 3/4 TON, G / EXPRESS Todos	
R	68-72	VAN 3/4 TON, P SERIES Todos	
R	70-72	<b>GMC JIMMY</b> 4x2 Tracción trasera	
R	67-72	PICKUP 1/2 TON, C15 / C1500	Todos
R	67-72	PICKUP 1 TON, C35/3500 Todos	Exc. Eje Trasero 11,000#
R	67-72	PICKUP 3/4 TON, C25 / C2500	Todos
R	67-72	PICKUP 1500 SERIES Todos	Múltiples
R	67-77	VAN 1/2 TON, G / SAVANNA Todos	
R	67	VAN 1/2 TON, P SERIES Todos	
R	76-77	VAN 1 TON, G / SAVANNA Todos	
R	75	VAN 1 TON, G / SAVANNA 110.0	(WheelBase)
R	75	VAN 1 TON, G / SAVANNA 125.0	(WheelBase)
R	71-74	VAN 1 TON, G / SAVANNA Todos	Exc. Base de rueda de 146"
R	68-72	VAN 1 TON, P SERIES Todos	Exc. Eje Trasero 11,000#
R	67-77	VAN 3/4 TON, G / SAVANNA Todos	
R	68-72	VAN 3/4 TON, P SERIES Todos	
R	63-65	VAN, PB 1000 SERIES Todos	
<b>49173</b>	W		<b>140126,141099</b>
R	66	<b>FORD BRONCO</b> Todos	Toda la serie #830000
R	75-79	PICKUP 1/2 TON, F-100 4x2	Tracción trasera
R	70-74	PICKUP 1/2 TON, F-100 Todos	Kit de Levantamiento
R	75-79	PICKUP 1/2 TON, F-150 4x2	Tracción trasera
R	75-79	PICKUP 1 TON, F-350 / SUPERDUTY	Cab & Chassis, 4x2
R	75-79	PICKUP 1 TON, F-350 / SUPERDUTY	Extended Cab Pickup, 4x2
R	74	PICKUP 1 TON, F-350 / SUPERDUTY	4x2 Tracción trasera Extended Cab & Chassis Cab

## Amortiguadores de Aire HiJackers

Amort.	POP	No. Alternativo	Montaje Accesorio
Pos.	Año	Aplicación	
<b>49173</b>	W	-continued	<b>140126,141099</b>
R	75-79	PICKUP 3/4 TON, F-250 / SUPERDUTY	Standard Cab Pickup, 4x2 Tracción trasera
R	71-74	PICKUP 3/4 TON, F-250 / SUPERDUTY	4x2 Tracción trasera
R	75-91	VAN 1/2 TON, ECONOLINE / CLUB	WAGON Todos
<b>49178</b>	W		<b>140126,141099</b>
R	75-76	<b>FORD</b> PICKUP 1/2 TON, F-100 4x4	Exc. Kit de Levantamiento
R	70-74	PICKUP 1/2 TON, F-100 Todos	Exc. Kit de Levantamiento
R	76-79	PICKUP 1/2 TON, F-150 4x4	Exc. Kit de Levantamiento
R	75	PICKUP 1/2 TON, F-150 Todos	4x4; Exc. Kit de Levantamiento
R	79	PICKUP 1 TON, F-350 / SUPERDUTY	4x4
R	77-79	PICKUP 3/4 TON, F-250 / SUPERDUTY	Cab & Chassis, 4x4
R	77-79	PICKUP 3/4 TON, F-250 / SUPERDUTY	Standard Cab Pickup, 4x4
R	92-11	VAN 1/2 TON, ECONOLINE / CLUB	WAGON Todos
R	77-11	VAN 1 TON, ECONOLINE / CLUB	WAGON / SUPERDUTY Todos
R	07	VAN 1 TON, ECONOLINE / CLUB	WAGON / SUPERDUTY Todos
R	75-91	VAN 1 TON, ECONOLINE / CLUB	WAGON / SUPERDUTY Todos
R	75-11	VAN 3/4 TON, ECONOLINE / CLUB	WAGON / SUPERDUTY Todos
<b>49197</b>	W		<b>141099</b>
R	80-96	<b>FORD BRONCO</b> Todos	Exc. Kit de Levantamiento
R	80-83	PICKUP 1/2 TON, F-100 4x2	Tracción trasera
R	80-84	PICKUP 1/2 TON, F-150 4x2	Tracción trasera
<b>49205</b>	W		<b>141150,141099</b>
R	92-02	<b>FORD CROWN VICTORIA</b> Todos	
R	87-91	LTD / COUNTRY SEDAN / COUNTRY SQUIRE / CROWN	VICTORIA Todos
<b>49207</b>	W		<b>141099</b>
R	89	<b>FORD BRONCO II</b> Todos	Fab. hasta 2/89; Vehículos con perno 10mm & 12mm en montaje inferior trasero
R	84-88	BRONCO II Todos	Con Perno de 10mm en Montaje Inferior Trasero
R	89	RANGER 4x2	Tracción trasera Fab. hasta 2/89; Vehículos con perno 10mm & 12mm en montaje inferior trasero
R	83-88	RANGER 4x2	Tracción trasera
<b>49212</b>	W		<b>141099</b>
R	78-95	<b>CHEVROLET</b> VAN 1/2 TON, G / EXPRESS	Todos
R	78-95	VAN 1 TON, G / EXPRESS	Cutaway Van
R	78-95	VAN 3/4 TON, G / EXPRESS	Todos
R	99-03	<b>DODGE</b> VAN 1/2 TON, A / B SERIES / RAM	109.3 (WheelBase) Exc. PBV 7000#
R	82-98	VAN 1/2 TON, A / B SERIES / RAM	109.6 (WheelBase) Exc. PBV 7000#
R	71-80	VAN 1/2 TON, A / B SERIES / RAM	Todos
R	99-03	VAN 1 TON, A / B SERIES / RAM	Todos
R	95-98	VAN 1 TON, A / B SERIES / RAM	Todos
R	71-94	VAN 1 TON, A / B SERIES / RAM	Todos
R	71-03	VAN 3/4 TON, A / B SERIES / RAM	Todos
R	78-80	VAN, CB300	Todos
R	77	VAN, CB300	Todos
R	75-76	VAN, CB300	Todos
R	74	VAN, CB300	Todos

## Lista numérica

Amort.	POP	No. Alternativo	Montaje Accesorio
Pos.	Año	Aplicación	
<b>49212</b>	W	-continued	<b>141099</b>
R	78-95	<b>GMC</b> VAN 1/2 TON, G / SAVANNA	Todos
R	85-96	VAN 1 TON, G / SAVANNA	Extended Cargo Van
R	85-96	VAN 1 TON, G / SAVANNA	Extended Passenger Van
R	79-96	VAN 1 TON, G / SAVANNA	Standard Cargo Van
R	79-96	VAN 1 TON, G / SAVANNA	Standard Passenger Van
R	78	VAN 1 TON, G / SAVANNA	Cutaway Van
R	78-95	VAN 3/4 TON, G / SAVANNA	Todos
R	74-83	<b>PLYMOUTH</b> VAN 1/2 TON, PB	SERIES Todos
R	74-83	VAN 1 TON, PB SERIES	Todos
R	74-83	VAN 3/4 TON, PB SERIES	Todos
<b>49213</b>	W		<b>141099</b>
R	05	<b>CHEVROLET</b> BLAZER	Base, 4x4
R	05	BLAZER	Base, 4x2 Tracción trasera
R	96-04	BLAZER	LS, 4x4
R	96-04	BLAZER	LS, 4x2 Tracción trasera
R	95-02	BLAZER	LT, 4x2 Tracción trasera
R	95-01	BLAZER	LT, 4x4
R	95-99	BLAZER	Base, 4x4
R	95-99	BLAZER	Base, 4x2 Tracción trasera
R	95-97	BLAZER	Deluxe, 4x2 Tracción trasera
R	83-94	BLAZER, S MODELS	Todos
R	99-04	S10	LS, 4x4
R	99-03	S10	Base, 4x4
R	99-03	S10	Base, 4x2 Tracción trasera
R	99-03	S10	LS, 4x2 Tracción trasera
R	94-98	S10	LS
R	82-98	S10	Base
R	92-93	S10	EL
R	83-92	S10	Tahoe
R	88-90	S10	Durango
R	82-86	S10	Durango
R	05	<b>GMC JIMMY</b>	4x4
R	92-04	JIMMY	Todos
R	83-91	S15	JIMMY Todos
R	82-04	SONOMA / S15	Todos
R	91	SYCLONE	Todos
R	92-93	TYPHOON	Todos
<b>49214</b>	C		<b>141099</b>
R	85-96	<b>FORD</b> PICKUP 1/2 TON, F-150 4x2	Tracción trasera
R	97	PICKUP 3/4 TON, F-250 / SUPERDUTY	4x2 Tracción trasera
R	80-96	PICKUP 3/4 TON, F-250 / SUPERDUTY	4x2 Tracción trasera
<b>49215</b>	W		<b>141099</b>
R	90-05	<b>CHEVROLET</b> ASTRO	Todos
R	85-89	ASTRO	4x2 Tracción trasera
R	90-05	<b>GMC SAFARI</b>	Todos
R	85-89	SAFARI	4x2 Tracción trasera
R	86-89	<b>VOLKSWAGEN</b> VANAGON	4x4
<b>49217</b>	D		<b>141099</b>
R	80-96	<b>FORD</b> PICKUP 1/2 TON, F-150 4x4	Exc. Kit de Levantamiento
R	82-85	PICKUP 1 TON, F-350 / SUPERDUTY	4x4 Montaje Inferior
R	80-81	PICKUP 1 TON, F-350 / SUPERDUTY	4x4 Montaje Inferior
R	86	PICKUP 3/4 TON, F-250 / SUPERDUTY	4x4
R	82-85	PICKUP 3/4 TON, F-250 / SUPERDUTY	4x4 Montaje Inferior
R	80-81	PICKUP 3/4 TON, F-250 / SUPERDUTY	4x4
<b>49218</b>	W		<b>141099</b>
R	88-99	<b>CHEVROLET</b> PICKUP 1/2 TON, C15 / C1500	Todos
R	88-99	PICKUP 1/2 TON, K15 / K1500	Todos
R	01-03	PICKUP 1 TON, C35/3500	Base Eje Delantero Rígido HD
R	91-00	PICKUP 1 TON, C35/3500	Todos
R	88-90	PICKUP 1 TON, C35/3500	Extended Cab Pickup Eje Delantero Rígido HD

Lista numérica

Amortiguadores de Aire HiJackers, Asiento de Resorte Ultra

Lista numérica

Amort.	POP	No. Alternativo	Montaje Accesorio
Pos.	Año	Aplicación	
<b>49218</b>	W	-continued	<b>141099</b>
R	88-90	PICKUP 1 TON, C35/3500 Standard Cab Pickup Eje Delantero Rígido HD	
R	88-00	PICKUP 1 TON, K35 / K3500 Todos	
R	88-00	PICKUP 3/4 TON, C25 / C2500 Todos	
R	88-00	PICKUP 3/4 TON, K25 / K2500 Todos	
R	88-99	<b>GMC</b> PICKUP 1/2 TON, C15 / C1500 Todos	
R	88-99	PICKUP 1/2 TON, K15 / K1500 Todos	
R	92-00	PICKUP 1 TON, C35/3500 Cab & Chassis Eje Delantero Rígido HD	
R	88-91	PICKUP 1 TON, C35/3500 Todos Eje Delantero Rígido HD	
R	88-00	PICKUP 1 TON, K35 / K3500 Todos	
R	88-00	PICKUP 3/4 TON, C25 / C2500 Todos	
R	88-00	PICKUP 3/4 TON, K25 / K2500 Todos	
<b>49221</b>	W		<b>141099</b>
R	90-97	<b>FORD AEROSTAR</b> Todos	
R	89	AEROSTAR 4x2 Tracción trasera	
<b>49222</b>	W		<b>141099</b>
R	87-95	<b>JEEP WRANGLER</b> YJ (Código plataforma del fabricante)	
<b>49223</b>	W		<b>141099</b>
R	90	<b>FORD BRONCO II</b> Todos	
R	89	BRONCO II Todos Fab. desde 2/89; Vehículos con perno de 12mm en montaje inferior trasero	
R	06	RANGER 4x2 Tracción trasera, Coil (FrontSpringType)	
R	90-05	RANGER 4x2 Tracción trasera	
R	89	RANGER 4x2 Tracción trasera Fab. desde 2/89; Vehículos con perno de 12mm en montaje inferior trasero	
R	94-97	<b>MAZDA B2300</b> 4x2 Tracción trasera	
<b>49225</b>	W		<b>140719,141099</b>
R	91-94	<b>FORD EXPLORER</b> Todos	
<b>49226</b>	W		<b>141099</b>
R	84-01	<b>JEEP CHEROKEE</b> Todos	
R	84-90	WAGONEER Todos	
<b>49230</b>	D		<b>141099</b>
R	05-08	<b>CHEVROLET UPLANDER</b> 4x2 Tracción delantera Suspensión con Nivelación Nuemática; Exc. Suspensión Trasera Independiente	
<b>49231</b>	W		<b>141099</b>
R	99-00	<b>CADILLAC ESCALADE</b> Todos	
R	92-94	<b>CHEVROLET BLAZER</b> 4x4 Automóvil Grande	
R	92-99	SUBURBAN 1/2 TON, C15 / C1500 Todos	
R	92-99	SUBURBAN 1/2 TON, K15 / K1500 Todos	
R	92-99	SUBURBAN 3/4 TON, C25 / C2500 Todos	
R	92-99	SUBURBAN 3/4 TON, K25 / K2500 Todos	
R	95-00	TAHOE Todos Old Body Style	
R	96-11	VAN 1/2 TON, G / EXPRESS Todos	
R	96-02	VAN 1 TON, G / EXPRESS Todos	
R	96-02	VAN 3/4 TON, G / EXPRESS Todos Exc. PBV 8600 #	
R	92-99	<b>GMC SUBURBAN</b> 1/2 TON, C15 / C1500 Todos	
R	92-99	SUBURBAN 1/2 TON, K15 / K1500 Todos	
R	92-99	SUBURBAN 3/4 TON, C25 / C2500 Todos	
R	92-99	SUBURBAN 3/4 TON, K25 / K2500 Todos	
R	96-11	VAN 1/2 TON, G / SAVANNA Todos	
R	97-02	VAN 1 TON, G / SAVANNA Todos	
R	96-02	VAN 3/4 TON, G / SAVANNA Todos Exc. PBV 8600 #	
R	92-99	YUKON Todos	
R	99	YUKON Denali, 4x4	
<b>49232</b>	W		<b>140719,141099</b>
R	95-01	<b>FORD EXPLORER</b> Todos Exc. Suspensión Electrónica Ajustable	
R	01-05	EXPLORER SPORT TRAC Todos	

Amort.	POP	No. Alternativo	Montaje Accesorio
Pos.	Año	Aplicación	
<b>49235</b>	W		<b>141099</b>
R	07	<b>CHEVROLET PICKUP</b> 1/2 TON, SILVERADO 1500 Classic Hybrid, 4x2 Tracción trasera Exc. Suspensión Electrónica Ajustable	
R	07	PICKUP 1/2 TON, SILVERADO 1500 Classic LS, 4x2 Tracción trasera Exc. Suspensión Electrónica Ajustable	
R	07	PICKUP 1/2 TON, SILVERADO 1500 Classic LT, 4x2 Tracción trasera Exc. Suspensión Electrónica Ajustable	
R	07	PICKUP 1/2 TON, SILVERADO 1500 Classic SS, 4x2 Tracción trasera Exc. Suspensión Electrónica Ajustable	
R	07	PICKUP 1/2 TON, SILVERADO 1500 Classic WT, 4x2 Tracción trasera Exc. Suspensión Electrónica Ajustable	
R	99-06	PICKUP 1/2 TON, SILVERADO 1500 4x2 Tracción trasera Exc. Suspensión Electrónica Ajustable	
R	94-01	<b>DODGE PICKUP</b> 1/2 TON, RAM 1500 Todos	
R	94-02	PICKUP 1 TON, RAM 3500 4x2 Tracción trasera Exc. Eje Delantero Rígido	
R	94-02	PICKUP 3/4 TON, RAM 2500 4x4, GAS Exc. PBV 8600 #	
R	94-02	PICKUP 3/4 TON, RAM 2500 4x2 Tracción trasera	
R	95-96	PICKUP 3/4 TON, RAM 2500 4x4, CNG Exc. PBV 8600 #	
R	07	<b>GMC SIERRA</b> 1500 Classic Hybrid, 4x2 Tracción trasera Exc. Suspensión Electrónica Ajustable	
R	07	SIERRA 1500 Classic SL, 4x2 Tracción trasera Exc. Suspensión Electrónica Ajustable	
R	07	SIERRA 1500 Classic SLE, 4x2 Tracción trasera Exc. Suspensión Electrónica Ajustable	
R	07	SIERRA 1500 Classic SLT, 4x2 Tracción trasera Exc. Suspensión Electrónica Ajustable	
R	07	SIERRA 1500 Classic WT, 4x2 Tracción trasera Exc. Suspensión Electrónica Ajustable	
R	99-06	SIERRA 1500 4x2 Tracción trasera Exc. Suspensión Electrónica Ajustable	
<b>49237</b>	W		<b>142700,141099</b>
R	04	<b>FORD PICKUP</b> 1/2 TON, F-150 4x2 Tracción trasera	
R	00-03	PICKUP 1/2 TON, F-150 Harley-Davidson Edition, 4x2 Tracción trasera	
R	99-03	PICKUP 1/2 TON, F-150 Lariat, 4x2 Tracción trasera	
R	99-03	PICKUP 1/2 TON, F-150 XL, 4x2 Tracción trasera	
R	99-03	PICKUP 1/2 TON, F-150 XLT, 4x2 Tracción trasera	
R	00	PICKUP 1/2 TON, F-150 Base, 4x2 Tracción trasera	
R	97-98	PICKUP 1/2 TON, F-150 4x2 Tracción trasera	
R	97-99	PICKUP 3/4 TON, F-250 / SUPERDUTY 4x2 Tracción trasera Hasta PBV 8500#	
<b>49241</b>	W		<b>141099</b>
R	97	<b>FORD PICKUP</b> 3/4 TON, F-250 / SUPERDUTY 4x4 PBV arriba de 8500#	
R	87-96	PICKUP 3/4 TON, F-250 / SUPERDUTY 4x4	
<b>49310</b>	W		<b>140788,141099</b>
R	87-93	<b>DODGE PICKUP</b> , RAM 50 4x2 Tracción trasera	
R	83-86	PICKUP, RAM 50 Todos	
R	55	<b>FORD F SERIES</b> Todos F-100	
R	61-64	PICKUP 1/2 TON, F-100 Todos	
R	61-66	PICKUP 1 TON, F-350 / SUPERDUTY Todos	
R	61-64	PICKUP 3/4 TON, F-250 / SUPERDUTY Todos	
R	68	<b>INTERNATIONAL</b> 908B Todos	
R	68	908C Todos	
R	68	1000B Todos	
R	68	1000C Todos	

Amort.	POP	No. Alternativo	Montaje Accesorio
Pos.	Año	Aplicación	
<b>49310</b>	W	-continued	<b>140788,141099</b>
R	68	1100B Todos Exc. Travelette c/ base de rueda de 166"	
R	68	1100C Todos Exc. Travelette c/ base de rueda de 166"	
R	68	1200B Todos Exc. Travelette c/ base de rueda de 166"	
R	68	1200C Todos Exc. Travelette c/ base de rueda de 166"	
R	68	1300B Todos Exc. Travelette c/ base de rueda de 166"	
R	68	1300C Todos Exc. Travelette c/ base de rueda de 166"	
R	68-72	M1100 / M1200 Todos	
R	69	M1400 Todos	
R	65-67	M SERIES VAN Todos	
R	72-83	<b>JEEP CJ5</b> Todos Exc. Kit de Levantamiento	
R	66-71	CJ5 Todos	
R	72-75	CJ6 Todos Exc. Kit de Levantamiento	
R	66-71	CJ6 Todos	
R	76-86	CJ7 Todos Exc. Kit de Levantamiento	
R	66-74	DJ5 Todos Exc. Kit de Levantamiento	
R	66-68	DJ6 Todos	
R	57-60	FC150 Todos	
R	63-65	FC170 Todos	
R	64-66	GLADIATOR Todos	
R	63	GLADIATOR Todos Suspensión Delantero Independiente	
R	70-73	JEEPSTER Todos	
R	81-85	SCRAMBLER / CJ8 Todos	
R	61-67	UNIVERSAL Todos	
R	86-87	<b>MAZDA B2000</b> 4x2 Tracción trasera	
R	87-93	B2200 4x2 Tracción trasera	
R	87-93	B2600 4x2 Tracción trasera	
R	87-90	<b>MITSUBISHI VAN</b> Todos	
R	98-04	<b>NISSAN FRONTIER</b> 4x2 Tracción trasera Exc. Desert Runner	
R	95-97	PICKUP 4x2 Tracción trasera	
R	65-93	PICKUP	
R	85-95	<b>TOYOTA PICKUP</b> 4x2 Tracción trasera Exc. 1 Ton	
R	84	PICKUP 4x2 Tracción trasera	
R	84-88	VAN Leaf (RearSpringType)	
R	88	VAN WAGON Leaf (FrontSpringType), Leaf (RearSpringType)	
<b>49311</b>	W		<b>141099</b>
R	81-95	<b>ISUZU PICKUP</b> Todos	
R	00-04	<b>NISSAN FRONTIER</b> Crew Cab Pickup, 4x2 Tracción trasera con Desert Runner	
R	98-04	FRONTIER 4x4	
R	98-99	FRONTIER 4x2 Tracción trasera Crew Cab con Desert Runner	
R	95-97	PICKUP 4x4	
R	65-93	PICKUP	
R	85-92	<b>TOYOTA PICKUP</b> 4x2 Tracción trasera 1 Ton	
R	80-83	PICKUP 4x4 Exc. Kit de Levantamiento	
<b>49387</b>	W		<b>140921,141099</b>
R	96-02	<b>TOYOTA 4RUNNER</b> Todos	
<b>49388</b>	W		<b>140921,141099</b>
R	90-95	<b>TOYOTA 4RUNNER</b> Todos	
<b>49616</b>	N		
R	00-06	<b>CHEVROLET SUBURBAN</b> 1/2 TON, 1500 Todos	
R	00-06	TAHOE Todos	
R	00-06	<b>GMC YUKON</b> Todos	
<b>Asiento de Resorte Ultra</b>			
<b>G51047</b>	W		<b>142101</b>
R	83-87	<b>DODGE CHARGER</b> Todos	
<b>G51077</b>	B		<b>142467</b>
F	96-02	<b>TOYOTA 4RUNNER</b> Todos	
F	98-04	TACOMA Pre Runner	
F	95-04	TACOMA 4x4	
<b>G51477</b>	B		<b>143008</b>
F	00-06	<b>TOYOTA TUNDRA</b> Todos	
<b>G51703</b>	B		
F	05-08	<b>FORD PICKUP</b> 1/2 TON, F-150 4x2 Tracción trasera	
F	04	PICKUP 1/2 TON, F-150 Lariat, 4x2 Tracción trasera	

## Lista numérica

Amort.	POP	No. Alternativo	Montaje Accesorio
Pos.	Año	Aplicación	
<b>G51703</b>	B	-continued	
F	04	PICKUP 1/2 TON, F-150 STX, 4x2 Tracción trasera	
F	04	PICKUP 1/2 TON, F-150 XL, 4x2 Tracción trasera	
F	04	PICKUP 1/2 TON, F-150 XLT, 4x2 Tracción trasera	
F	06-08	<b>LINCOLN</b> MARK LT 4x2 Tracción trasera	
<b>G51704</b>	B		
F	04-08	<b>FORD</b> PICKUP 1/2 TON, F-150 4x4	
F	06-08	<b>LINCOLN</b> MARK LT 4x4	
<b>G51715</b>	C		
F	04-13	<b>NISSAN</b> TITAN Todos	
<b>G51718</b>	C		
F	03-09	<b>CHEVROLET</b> TRAILBLAZER Todos	
F	02	TRAILBLAZER Coil (RearSpringType)	
F	02-09	<b>GMC</b> ENVÓY Todos	
<b>G51719</b>	D		
F	03-06	<b>FORD</b> EXPEDITION 4x2 Tracción trasera	
<b>G51720</b>	D		
F	03-06	<b>FORD</b> EXPEDITION 4x4	
<b>G51721</b>	C	142154	
R	06-09	<b>DODGE</b> CHARGER Todos Exc. Paquete Policía w/Suspensión Nivomat	
<b>G51722</b>	C		
F	02-03	<b>FORD</b> EXPLORER Eddie Bauer Exc. Todos los Modelos Sport & Sport Trac	
F	02-03	EXPLORER Limited Exc. Todos los Modelos Sport & Sport Trac	
F	02-03	EXPLORER Postal Exc. Todos los Modelos Sport & Sport Trac	
<b>G51723</b>	C		
F	04-05	<b>FORD</b> EXPLORER Eddie Bauer Exc. Todos los Modelos Sport & Sport Trac	
F	04-05	EXPLORER Limited Exc. Todos los Modelos Sport & Sport Trac	
<b>G51724</b>	C		
R	02-05	<b>FORD</b> EXPLORER Eddie Bauer Exc. Todos los Modelos Sport & Sport Trac	
R	02-05	EXPLORER Limited Exc. Todos los Modelos Sport & Sport Trac	
R	02-03	EXPLORER Postal Exc. Todos los Modelos Sport & Sport Trac	
<b>G51728</b>	B		
F	02-12	<b>JEEP</b> LIBERTY Todos	
<b>G51729</b>	D		
R	03-06	<b>FORD</b> EXPEDITION Todos	
R	03-05	<b>LINCOLN</b> NAVIGATOR Todos	
<b>G51739</b>	C		
F	12	<b>TOYOTA</b> 4RUNNER Todos Exc. Suspensión X-REAS; Exc. Modelos Deportivos	
F	10-11	4RUNNER Trail Exc. Suspensión X-REAS	
F	03-11	4RUNNER Limited Exc. Suspensión X-REAS	
F	03-11	4RUNNER SR5 Exc. Suspensión X-REAS	
F	07-12	FJ CRUISER Todos	
F	05-13	TACOMA 4x4	
F	05-13	TACOMA Pre Runner	
<b>G51758</b>	C		
F	06-08	<b>DODGE</b> PICKUP 1/2 TON, RAM 1500 4x4 Exc. Mega Cab	
<b>G51760</b>	C	140953	
F	06-10	<b>DODGE</b> CHARGER 4x2 Tracción trasera Derecho	
<b>G51761</b>	C	140953	
F	06-10	<b>DODGE</b> CHARGER 4x2 Tracción trasera Izquierdo	
<b>G51766</b>	C		
F	11-13	<b>NISSAN</b> FRONTIER S	
F	13	FRONTIER LE	
F	13	FRONTIER PRO-4X	

## Asiento de Resorte Ultra, Struts Ultra

Amort.	POP	No. Alternativo	Montaje Accesorio
Pos.	Año	Aplicación	
<b>G51766</b>	C	-continued	
F	13	FRONTIER SL	
F	13	FRONTIER SV	
F	12	FRONTIER LE Fab. hasta 12/12	
F	12	FRONTIER PRO-4X Fab. hasta 12/12	
F	12	FRONTIER SL Fab. hasta 12/12	
F	09-11	FRONTIER PRO-4X	
F	05-11	FRONTIER LE	
F	11	FRONTIER SL	
F	05-10	FRONTIER SE	
F	05-06	FRONTIER XE	
<b>G51815</b>	B		
F	06-09	<b>NISSAN</b> TITAN Todos	
<b>G51842</b>	B	141716	
R	07-11	<b>DODGE</b> CALIBER Todos	
<b>G51850</b>	B		
F	04-11	<b>CHEVROLET</b> COLORADO 4x2 Tracción trasera, Coil (FrontSpringType) Exc. Paquete Z71 Off Road	
F	04-11	<b>GMC</b> CANYON 4x2 Tracción trasera, Coil (FrontSpringType) Exc. Paquete Z71 Off Road	
F	06	<b>ISUZU</b> I-280 4x2 Tracción trasera Exc. Paquete Z71 Off Road	
<b>G51853</b>	D		
F	05-09	<b>TOYOTA</b> TACOMA Base, 4x2 Tracción trasera Izquierdo	
F	05-09	TACOMA X-Runner Izquierdo	
<b>G51854</b>	D		
F	05-09	<b>TOYOTA</b> TACOMA Base, 4x2 Tracción trasera Derecho	
F	05-09	TACOMA X-Runner Derecho	
<b>G51855</b>	C		
F	07-13	<b>TOYOTA</b> TUNDRA Todos	
<b>G51856</b>	B		
F	09-10	<b>DODGE</b> PICKUP 1/2 TON, RAM 1500 4x4	
F	11-14	RAM 1500	
F	11-14	RAM 1500 (SEE DODGE RAM 1500) 4x4	
<b>G51860</b>	C		
F	07-12	<b>FORD</b> EXPEDITION Coil (RearSpringType) Exc. Suspensión de Aire	
F	07-12	<b>LINCOLN</b> NAVIGATOR Todos	
<b>G51861</b>	C		
R	07-12	<b>FORD</b> EXPEDITION Coil (RearSpringType) Exc. Suspensión de Aire	
R	07-12	<b>LINCOLN</b> NAVIGATOR Todos	
<b>G51864</b>	C		
F	09-13	<b>FORD</b> PICKUP 1/2 TON, F-150 4x4	
F	09-12	<b>LINCOLN</b> MARK LT	
<b>G51865</b>	C		
F	09-13	<b>FORD</b> PICKUP 1/2 TON, F-150 4x2 Tracción trasera	
F	09-12	<b>LINCOLN</b> MARK LT	
<b>G51870</b>	A		
F	07-13	<b>CHEVROLET</b> CHEYENNE	
F	08-13	PICKUP 1/2 TON, SILVERADO 1500 Todos Exc. Suspensión Electrónica Ajustable	
F	07	PICKUP 1/2 TON, SILVERADO 1500 Base Exc. Suspensión Electrónica Ajustable	
F	07	PICKUP 1/2 TON, SILVERADO 1500 LS Exc. Suspensión Electrónica Ajustable	
F	07	PICKUP 1/2 TON, SILVERADO 1500 LT Exc. Suspensión Electrónica Ajustable	
F	07	PICKUP 1/2 TON, SILVERADO 1500 LTZ Exc. Suspensión Electrónica Ajustable	
F	07	PICKUP 1/2 TON, SILVERADO 1500 WT Exc. Suspensión Electrónica Ajustable	
F	08-13	<b>GMC</b> SIERRA 1500 Todos Exc. Suspensión Electrónica Ajustable	
F	07	SIERRA 1500 SLE Exc. Suspensión Electrónica Ajustable	
F	07	SIERRA 1500 SLT Exc. Suspensión Electrónica Ajustable	

## Lista numérica

Amort.	POP	No. Alternativo	Montaje Accesorio
Pos.	Año	Aplicación	
<b>G51870</b>	A	-continued	
F	07	SIERRA 1500 WT Exc. Suspensión Electrónica Ajustable	
<b>G51880</b>	C		
R	06-10	<b>HONDA</b> RIDGELINE Todos	
<b>G51887</b>	D		
F	10-11	<b>FORD</b> CROWN VICTORIA Base	
F	07-11	CROWN VICTORIA LX	
F	03-08	CROWN VICTORIA Base	
F	04-06	CROWN VICTORIA LX Sport	
F	05	CROWN VICTORIA Special Edition	
F	03	CROWN VICTORIA LWB	
F	03	CROWN VICTORIA S	
<b>G51888</b>	W		
F	03-11	<b>FORD</b> CROWN VICTORIA Police Interceptor	
<b>G51891</b>	B		
F	07-13	<b>CHEVROLET</b> AVALANCHE 1500 Todos Exc. Suspensión Z55 o ZW7	
F	07-14	SUBURBAN 1/2 TON, 1500 Todos Exc. Suspensión Z55 o ZW7	
F	07-14	TAHOE Todos Exc. Suspensión Z55 o ZW7	
F	07-14	<b>GMC</b> YUKON Todos Exc. Suspensión Z55 o ZW7	
F	07-14	YUKON XL 1/2 TON Todos Exc. Suspensión Z55 o ZW7	
<b>G51947</b>	W		
F	06-10	<b>DODGE</b> CHARGER 4x2 Tracción trasera Izquierdo Modelos Policía	
<b>G51948</b>	W		
F	06-10	<b>DODGE</b> CHARGER 4x2 Tracción trasera Derecho Modelos Policía	
<b>G51949</b>	D		
F	14	<b>CHEVROLET</b> CHEYENNE	
F	14	PICKUP 1/2 TON, SILVERADO 1500 Todos	
F	14	<b>GMC</b> SIERRA 1500 Todos	
<b>Struts Ultra</b>			
<b>G52025</b>	B		
F	05-09	<b>CHEVROLET</b> UPLANDER Todos Exc. Suspensión con Nivelación Neumática	
<b>G52040</b>	B		
F	03-08	<b>RENAULT</b> KANGOO	
<b>G52046</b>	C		
F	03-09	<b>PEUGEOT</b> GRAND RAID	
F	03-09	PARTNER Todos Izquierdo	
<b>G52047</b>	C		
F	03-09	<b>PEUGEOT</b> GRAND RAID	
F	03-09	PARTNER Todos Derecho	
<b>G52081</b>	B	141682	
F	07-11	<b>DODGE</b> CALIBER Todos Izquierdo	
<b>G52082</b>	B	141682	
F	07-11	<b>DODGE</b> CALIBER Todos Derecho	
<b>G52150</b>	D		
F	06-11	<b>HONDA</b> RIDGELINE Todos Izquierdo	
<b>G52151</b>	D		
F	06-11	<b>HONDA</b> RIDGELINE Todos Derecho	
<b>G52205</b>	D		
F	07-10	<b>FORD</b> EXPLORER SPORT TRAC Todos	
<b>G52206</b>	D		
R	07-10	<b>FORD</b> EXPLORER SPORT TRAC Todos	
<b>G52216</b>	D		
F	07-11	<b>RENAULT</b> TRAFIC	
<b>G52220</b>	N		
F	07-10	<b>FORD</b> TRANSIT	
<b>G52244</b>	W		
R	04-11	<b>CHEVROLET</b> IMPALA Todos Modelos con Llantas de 17" o 18"	
<b>G52341</b>	N		
F	07-10	<b>MERCEDES-BENZ</b> SPRINTER 415 & 515	

Lista numérica

Amort.	POP	No. Alternativo	Montaje Accesorio
Pos.	Año	Aplicación	
G52341	N	-continued	
F	10-11	VOLKSWAGEN CRAFTER VAN	
G52342	FF		
F	05-10	VOLKSWAGEN EUROVAN	
F	10-13	TRANSPORTER Todos	
G52343	N		
F	07-10	MERCEDES-BENZ SPRINTER 315	
F	08-11	VW CRAFTER	
F	08-13	VOLKSWAGEN CRAFTER VAN	
G55507	W	140896	
F	83-87	DODGE CHARGER Todos	
G55527	W	141309	
F	95	MERCEDES-BENZ E300 Todos	
F	94	E500 Todos	
G55948	B	142169	
F	00-11	CHEVROLET IMPALA Todos	
G55949	C	142169	
R	00-11	CHEVROLET IMPALA Todos Exc. Modelos c/ Ruedas de 17" o 18"	
G56568	B		
F	01-12	FORD ESCAPE Todos Derecho	
G56601	B		
F	01-12	FORD ESCAPE Todos Izquierdo	
G56701	W	141313	
F	85-90	CADILLAC COMMERCIAL CHASSIS Todos	
G56707	W	142714	
R	92-93	CADILLAC COMMERCIAL CHASSIS 4x2 Tracción delantera Reemplazo Tipo Convencional para Susp. Trasera Asistida por Aire; Exc. Susp. Elect.	
R	85-91	COMMERCIAL CHASSIS Todos Reemplazo Tipo Convencional para Susp. Trasera Asistida por Aire; Exc. Susp. Elect.	
G56718	W	141683	
F	92-93	CADILLAC COMMERCIAL CHASSIS 4x2 Tracción delantera	
F	91	COMMERCIAL CHASSIS Todos	
G56778	C	143172	
F	03-06	DODGE SPRINTER 2500 Todos	
F	03-06	SPRINTER 3500 Todos	
F	04-06	MERCEDES-BENZ SPRINTER Todos	
G56807	C	141727	
F	06-10	JEEP COMMANDER Todos	
F	05-10	GRAND CHEROKEE Todos	
G56838	C	141727	
F	06-10	FORD EXPLORER Todos	
G56839	C	141727	
R	06-10	FORD EXPLORER Todos	
G56903	W		
R	92-93	CADILLAC COMMERCIAL CHASSIS 4x2 Tracción delantera Suspensión Trasera Asistida por Aire; Exc. Suspensión Electrónica Ajustable	
R	91	COMMERCIAL CHASSIS Todos Suspensión Trasera Asistida por Aire; Exc. Suspensión Electrónica Ajustable	
R	85-90	COMMERCIAL CHASSIS Todos Equipamiento Estándar para Suspensión Trasera Asistida por Aire	
<b>Amortiguadores LTV</b>			
58183	W	140357	
F	81-93	DODGE PICKUP 1/2 TON, W100 SERIES Todos Exc. Kit de Levantamiento	
F	61-80	PICKUP 1/2 TON, W100 SERIES Todos	
F	81-93	PICKUP 1 TON, W300 SERIES Todos Exc. Suspensión Quad y Kit de Levantamiento	
F	61-80	PICKUP 1 TON, W300 SERIES Todos	
R	61-71	PICKUP 1 TON, W300 SERIES Todos	

Struts Ultra, Amortiguadores LTV

Amort.	POP	No. Alternativo	Montaje Accesorio
Pos.	Año	Aplicación	
58183	W	-continued	
F	81-93	PICKUP 3/4 TON, W200 SERIES Standard Cab Pickup Exc. Kit de Levantamiento	
F	69-80	PICKUP 3/4 TON, W200 SERIES Todos	
F	61-67	PICKUP 3/4 TON, W200 SERIES Todos	
F	75-93	RAMCHARGER 4x4	
F	74	RAMCHARGER Todos	
F	75-81	PLYMOUTH TRAILDUSTER 4x4	
F	74	TRAILDUSTER Todos	
58347	W	140357	
F	87-91	CHEVROLET BLAZER 4x4 Automóvil Grande; Exc. Suspensión Quad y Kit de Levantamiento	
F	75-86	BLAZER 4x4 Exc. Suspensión Quad y Kit de Levantamiento	
F	73-74	BLAZER 4x4 Exc. Kit de Levantamiento	
F	69-72	BLAZER 4x4	
F	81-86	PICKUP 1/2 TON, K10 Todos Suspensión Estándar; Exc. Kit de Levantamiento	
F	69-80	PICKUP 1/2 TON, K10 Todos Exc. Kit de Levantamiento	
F	87	PICKUP 1/2 TON, V10 Todos Exc. Suspensión Quad y Kit de Levantamiento	
F	81-86	PICKUP 3/4 TON, K20 Todos Suspensión Estándar; Exc. Kit de Levantamiento	
F	69-80	PICKUP 3/4 TON, K20 Todos Exc. Kit de Levantamiento	
F	87	PICKUP 3/4 TON, V20 Todos Exc. Suspensión Quad y Kit de Levantamiento	
F	81-86	SUBURBAN 1/2 TON, K10 Todos Suspensión Estándar; Exc. Kit de Levantamiento	
F	69-80	SUBURBAN 1/2 TON, K10 Todos Exc. Kit de Levantamiento	
F	81-86	SUBURBAN 3/4 TON, K20 Todos Suspensión Estándar; Exc. Kit de Levantamiento	
F	69-80	SUBURBAN 3/4 TON, K20 Todos Exc. Kit de Levantamiento	
F	87-88	SUBURBAN 3/4 TON, V20 Todos Exc. Suspensión Quad y Kit de Levantamiento	
F	89-91	SUBURBAN 3/4 TON, V2500 Todos Exc. Suspensión Quad y Kit de Levantamiento	
F	70-91	GMC JIMMY 4x4 Exc. Suspensión Quad y Kit de Levantamiento	
F	69-86	PICKUP 1/2 TON, K15 / K1500 Todos Exc. Suspensión Quad y Kit de Levantamiento	
F	87	PICKUP 1/2 TON, V1500 Todos Exc. Suspensión Quad y Kit de Levantamiento	
F	69-86	PICKUP 3/4 TON, K25 / K2500 Todos Exc. Suspensión Quad y Kit de Levantamiento	
F	87	PICKUP 3/4 TON, V2500 Todos Exc. Suspensión Quad y Kit de Levantamiento	
F	69-86	SUBURBAN 1/2 TON, K15 / K1500 Todos Exc. Suspensión Quad y Kit de Levantamiento	
F	87-91	SUBURBAN 1/2 TON, V1500 Todos Exc. Suspensión Quad y Kit de Levantamiento	
F	69-86	SUBURBAN 3/4 TON, K25 / K2500 Todos Exc. Suspensión Quad y Kit de Levantamiento	
F	87-91	SUBURBAN 3/4 TON, V2500 Todos Exc. Suspensión Quad y Kit de Levantamiento	
58349	W	140357	
R	87-91	CHEVROLET BLAZER Todos Automóvil Grande; Exc. Suspensión Quad y Kit de Levantamiento	
R	73-86	BLAZER Todos Exc. Kit de Levantamiento	
R	73-86	PICKUP 1/2 TON, C10 Todos	
R	81-86	PICKUP 1/2 TON, K10 Todos Suspensión Estándar; Exc. Kit de Levantamiento	
R	73-80	PICKUP 1/2 TON, K10 Todos Exc. Kit de Levantamiento	
R	87	PICKUP 1/2 TON, R10 Todos	

Lista numérica

Amort.	POP	No. Alternativo	Montaje Accesorio
Pos.	Año	Aplicación	
58349	W	-continued	
R	87	PICKUP 1/2 TON, V10 Todos Exc. Suspensión Quad y Kit de Levantamiento	
R	73-74	PICKUP 3/4 TON, C20 Todos Standard Cab Pickup	
R	81-86	PICKUP 3/4 TON, K20 Todos Suspensión Estándar; Exc. Kit de Levantamiento	
R	73-80	PICKUP 3/4 TON, K20 Todos Exc. Kit de Levantamiento	
R	87	PICKUP 3/4 TON, R20 Standard Cab Pickup	
R	87	PICKUP 3/4 TON, V20 Todos Exc. Suspensión Quad y Kit de Levantamiento	
R	73-86	SUBURBAN 1/2 TON, C10 Todos	
R	81-86	SUBURBAN 1/2 TON, K10 Todos Suspensión Estándar; Exc. Kit de Levantamiento	
R	73-80	SUBURBAN 1/2 TON, K10 Todos Exc. Kit de Levantamiento	
R	87-88	SUBURBAN 1/2 TON, R10 Todos	
R	89-91	SUBURBAN 1/2 TON, R1500 Todos	
R	87-88	SUBURBAN 1/2 TON, V10 Todos Exc. Suspensión Quad y Kit de Levantamiento	
R	89-91	SUBURBAN 1/2 TON, V1500 Todos Exc. Suspensión Quad y Kit de Levantamiento	
R	73-86	SUBURBAN 3/4 TON, C20 Todos	
R	81-86	SUBURBAN 3/4 TON, K20 Todos Suspensión Estándar; Exc. Kit de Levantamiento	
R	73-80	SUBURBAN 3/4 TON, K20 Todos Exc. Kit de Levantamiento	
R	87-88	SUBURBAN 3/4 TON, R20 Todos	
R	89-91	SUBURBAN 3/4 TON, R2500 Todos	
R	87-88	SUBURBAN 3/4 TON, V20 Todos Exc. Suspensión Quad y Kit de Levantamiento	
R	89-91	SUBURBAN 3/4 TON, V2500 Todos Exc. Suspensión Quad y Kit de Levantamiento	
R	73	VAN 1/2 TON, P SERIES Todos	
R	73-78	VAN 3/4 TON, P SERIES Todos	
R	73-91	GMC JIMMY Todos Exc. Suspensión Quad y Kit de Levantamiento	
R	73-86	PICKUP 1/2 TON, C15 / C1500 Todos	
R	73-86	PICKUP 1/2 TON, K15 / K1500 Todos Exc. Suspensión Quad y Kit de Levantamiento	
R	87	PICKUP 1/2 TON, R1500 Todos	
R	87	PICKUP 1/2 TON, V1500 Todos Exc. Kit de Levantamiento	
R	75-86	PICKUP 3/4 TON, C25 / C2500 Cab & Chassis	
R	75-86	PICKUP 3/4 TON, C25 / C2500 Standard Cab Pickup	
R	73-74	PICKUP 3/4 TON, C25 / C2500 Todos Exc. Crew Cab & Bonus Cab	
R	73-86	PICKUP 3/4 TON, K25 / K2500 Todos Exc. Suspensión Quad y Kit de Levantamiento	
R	88-89	PICKUP 3/4 TON, R2500 Todos Exc. Crew Cab & Bonus Cab	
R	87	PICKUP 3/4 TON, R2500 Cab & Chassis Exc. Crew Cab & Bonus Cab	
R	87	PICKUP 3/4 TON, R2500 Standard Cab Pickup Exc. Crew Cab & Bonus Cab	
R	87	PICKUP 3/4 TON, V2500 Todos Exc. Kit de Levantamiento	
R	73-86	SUBURBAN 1/2 TON, C15 / C1500 Todos	
R	73-86	SUBURBAN 1/2 TON, K15 / K1500 Todos Exc. Suspensión Quad y Kit de Levantamiento	
R	87-91	SUBURBAN 1/2 TON, R1500 Todos	
R	87-91	SUBURBAN 1/2 TON, V1500 Todos Exc. Kit de Levantamiento	
R	73-86	SUBURBAN 3/4 TON, C25 / C2500 Todos	
R	73-86	SUBURBAN 3/4 TON, K25 / K2500 Todos Exc. Suspensión Quad y Kit de Levantamiento	
R	87-91	SUBURBAN 3/4 TON, R2500 Todos	
R	87-91	SUBURBAN 3/4 TON, V2500 Todos Exc. Kit de Levantamiento	
R	73	VAN 1/2 TON, P SERIES Todos	
R	73-78	VAN 3/4 TON, P SERIES Todos	

Lista numérica

Amort.	POP	No. Alternativo	Montaje Accesorio
Pos.	Año	Aplicación	
<b>58350</b>	W		<b>140126</b>
R 66		<b>FORD BRONCO</b> Todos Toda la serie #830000	
R 75-79		PICKUP 1/2 TON, F-100 4x2 Tracción trasera	
R 70-74		PICKUP 1/2 TON, F-100 Todos 4x2 Tracción trasera	
R 75-79		PICKUP 1/2 TON, F-150 4x2 Tracción trasera	
R 75-79		PICKUP 1 TON, F-350 / SUPERDUTY Extended Cab Pickup, 4x2 Tracción trasera	
R 74		PICKUP 1 TON, F-350 / SUPERDUTY Todos 4x2 Tracción trasera; Exc. Supercab	
R 75-79		PICKUP 3/4 TON, F-250 / SUPERDUTY Cab & Chassis, 4x2 Tracción trasera	
R 75-79		PICKUP 3/4 TON, F-250 / SUPERDUTY Standard Cab Pickup, 4x2 Tracción trasera	
R 73-74		PICKUP 3/4 TON, F-250 / SUPERDUTY 4x2 Tracción trasera Exc. Supercab	
R 70-72		PICKUP 3/4 TON, F-250 / SUPERDUTY 4x2 Tracción trasera	
R 75-91		VAN 1/2 TON, ECONOLINE / CLUB WAGON Todos	
<b>58353</b>	W		
R 72-93		<b>DODGE</b> PICKUP 1/2 TON, D100 SERIES Todos	
R 72-93		PICKUP 1 TON, D300 SERIES Todos	
R 72-93		PICKUP 3/4 TON, D200 SERIES Todos	
R 76-93		RAMCHARGER 4x2 Tracción trasera	
R 74-75		RAMCHARGER Todos	
R 75-81		<b>PLYMOUTH</b> TRAILDUSTER 4x2 Tracción trasera	
R 74		TRAILDUSTER Todos	
<b>58355</b>	W		<b>140702</b>
F 69-84		<b>CHEVROLET</b> BLAZER 4x2 Tracción trasera	
F 63-86		PICKUP 1/2 TON, C10 Todos	
F 87		PICKUP 1/2 TON, R10 Todos	
F 63-86		PICKUP 1 TON, C30 Todos	
F 88-91		PICKUP 1 TON, C35/3500 Cab & Chassis Exc. Eje Rígido Delantero HD	
F 87-88		PICKUP 1 TON, R30 Todos	
F 89		PICKUP 1 TON, R3500 Standard Cab Pickup	
F 63-74		PICKUP 3/4 TON, C20 Todos	
F 88		PICKUP 3/4 TON, R20 Todos	
F 87		PICKUP 3/4 TON, R20 Crew Cab Pickup	
F 87		PICKUP 3/4 TON, R20 Standard Cab Pickup	
F 89		PICKUP 3/4 TON, R2500 Todos	
F 63-67		SUBURBAN 1/2 TON, 1500 Todos	
F 63-86		SUBURBAN 1/2 TON, C10 Todos	
F 87-88		SUBURBAN 1/2 TON, R10 Todos	
F 89-91		SUBURBAN 1/2 TON, R1500 Todos	
F 68-86		SUBURBAN 3/4 TON, C20 Todos	
F 87-88		SUBURBAN 3/4 TON, R20 Todos	
F 89-91		SUBURBAN 3/4 TON, R2500 Todos	
F 63-80		VAN 1/2 TON, P SERIES Todos	
F 68-89		VAN 3/4 TON, P SERIES Todos	
F 70-84		<b>GMC</b> JIMMY 4x2 Tracción trasera	
F 67-86		PICKUP 1/2 TON, C15 / C1500 Todos	
F 87		PICKUP 1/2 TON, R1500 Todos	
F 88-90		PICKUP 1 TON, C35/3500 Cab & Chassis Eje Delantero Rígido HD	
F 67-78		PICKUP 1 TON, C35/3500 Todos	
F 87-91		PICKUP 1 TON, R3500 Todos	
F 85-86		PICKUP 3/4 TON, C25 / C2500 Crew Cab Pickup	
F 75-86		PICKUP 3/4 TON, C25 / C2500 Cab & Chassis	
F 75-86		PICKUP 3/4 TON, C25 / C2500 Standard Cab Pickup	
F 75-83		PICKUP 3/4 TON, C25 / C2500 Crew Cab Pickup	
F 67-74		PICKUP 3/4 TON, C25 / C2500 Todos	
F 87-89		PICKUP 3/4 TON, R2500 Todos Exc. Crew Cab & Bonus Cab	
F 63-65		PICKUP 1500 SERIES Todos	
F 68-86		SUBURBAN 1/2 TON, C15 / C1500 Todos	
F 87-91		SUBURBAN 1/2 TON, R1500 Todos	

Amortiguadores LTV

Amort.	POP	No. Alternativo	Montaje Accesorio
Pos.	Año	Aplicación	
<b>58355</b>	W	-continued	<b>140702</b>
F 68-86		SUBURBAN 3/4 TON, C25 / C2500 Todos	
F 87-91		SUBURBAN 3/4 TON, R2500 Todos	
F 67-80		VAN 1/2 TON, P SERIES Todos	
F 75-90		VAN 1 TON, P SERIES Todos Exc. Chasis Motorhome	
F 74		VAN 1 TON, P SERIES Base Exc. Chasis Motorhome	
F 73		VAN 1 TON, P SERIES Todos Exc. Chasis Motorhome	
F 68-72		VAN 1 TON, P SERIES Todos	
F 68-89		VAN 3/4 TON, P SERIES Todos	
F 63-65		VAN, PB 1000 SERIES Todos	
<b>58357</b>	W		
F 71-95		<b>CHEVROLET</b> VAN 1/2 TON, G / EXPRESS Todos	
F 70		VAN 1/2 TON, G / EXPRESS Todos Suspensión Delantero Independiente	
F 78-96		VAN 1 TON, G / EXPRESS Todos	
F 96		VAN 1 TON, G / EXPRESS Cutaway Van	
F 75		VAN 1 TON, G / EXPRESS 146.0 (WheelBase)	
F 71-74		VAN 1 TON, G / EXPRESS Todos	
F 78-95		VAN 3/4 TON, G / EXPRESS Todos Exc. PBV 8600 #	
F 70-77		VAN 3/4 TON, G / EXPRESS Todos	
F 70-95		<b>GMC</b> VAN 1/2 TON, G / SAVANNA Todos	
F 76-96		VAN 1 TON, G / SAVANNA Todos	
F 75		VAN 1 TON, G / SAVANNA 110.0 (WheelBase)	
F 75		VAN 1 TON, G / SAVANNA 125.0 (WheelBase)	
F 71-74		VAN 1 TON, G / SAVANNA Todos	
F 78-95		VAN 3/4 TON, G / SAVANNA Todos Exc. PBV 8600 #	
F 71-77		VAN 3/4 TON, G / SAVANNA Todos	
F 70		VAN 3/4 TON, G / SAVANNA Todos Suspensión Delantero Independiente	
<b>58359</b>	D		<b>140126</b>
F 72-93		<b>DODGE</b> PICKUP 1/2 TON, D100 SERIES Todos	
F 72-93		PICKUP 3/4 TON, D200 SERIES Todos Exc. Paquete HD	
F 75-93		RAMCHARGER 4x2 Tracción trasera	
F 99-03		VAN 1/2 TON, A / B SERIES / RAM 109.3 (WheelBase) Exc. PBV 7000#	
F 81-98		VAN 1/2 TON, A / B SERIES / RAM 109.6 (WheelBase) Exc. PBV 7000#	
F 71-80		VAN 1/2 TON, A / B SERIES / RAM Todos	
F 99-03		VAN 1 TON, A / B SERIES / RAM Todos	
F 71-98		VAN 1 TON, A / B SERIES / RAM Todos Exc. Eje Delantero 4000#	
F 71-03		VAN 3/4 TON, A / B SERIES / RAM Todos	
F 78-80		VAN, CB300 Todos Exc. Eje Delantero 4000#	
F 74-77		VAN, CB300 Todos Hasta PBV 8300#	
F 75-81		<b>PLYMOUTH</b> TRAILDUSTER 4x2 Tracción trasera	
F 74-83		VAN 1/2 TON, PB SERIES Todos	
F 74-83		VAN 1 TON, PB SERIES Todos Exc. Eje Delantero 4000#	
F 74-83		VAN 3/4 TON, PB SERIES Todos	
<b>58360</b>	W		<b>140126</b>
F 72-93		<b>DODGE</b> PICKUP 1 TON, D300 SERIES Todos	
F 82-93		PICKUP 3/4 TON, D200 SERIES Todos Paquete HD	
F 81		PICKUP 3/4 TON, D200 SERIES 165.0 (WheelBase) Paquete HD	
F 77-80		PICKUP 3/4 TON, D200 SERIES Todos Paquete HD	
F 75-76		PICKUP 3/4 TON, D200 SERIES 165.0 (WheelBase) Paquete HD	
F 72-74		PICKUP 3/4 TON, D200 SERIES Todos Paquete HD	
F 71-93		VAN 1 TON, A / B SERIES / RAM Todos Con Eje Delantero 4000#	
F 74-80		VAN, CB300 Todos PBV arriba de 8300#	
F 74-83		<b>PLYMOUTH</b> VAN 1 TON, PB SERIES Todos Con Eje Delantero 4000#	

Lista numérica

Amort.	POP	No. Alternativo	Montaje Accesorio
Pos.	Año	Aplicación	
<b>58366</b>	W		
R 73-86		<b>CHEVROLET</b> PICKUP 1 TON, C30 Todos	
R 88-91		PICKUP 1 TON, C35/3500 Cab & Chassis Exc. Eje Rígido Delantero HD	
R 87-88		PICKUP 1 TON, R30 Todos	
R 89		PICKUP 1 TON, R3500 Standard Cab Pickup	
R 73-74		PICKUP 3/4 TON, C20 Todos Crew Cab Pickup	
R 88		PICKUP 3/4 TON, R20 Todos	
R 87		PICKUP 3/4 TON, R20 Crew Cab Pickup	
R 89		PICKUP 3/4 TON, R2500 Todos	
R 74-80		VAN 1/2 TON, P SERIES Todos	
R 79-89		VAN 3/4 TON, P SERIES Todos	
R 88-91		<b>GMC</b> PICKUP 1 TON, C35/3500 Cab & Chassis Exc. Eje Rígido Delantero HD	
R 73-78		PICKUP 1 TON, C35/3500 Todos	
R 87-91		PICKUP 1 TON, R3500 Todos	
R 85-86		PICKUP 3/4 TON, C25 / C2500 Crew Cab Pickup	
R 75-83		PICKUP 3/4 TON, C25 / C2500 Crew Cab Pickup	
R 87-89		PICKUP 3/4 TON, R2500 Crew Cab Pickup	
R 74-80		VAN 1/2 TON, P SERIES Todos	
R 74-99		VAN 1 TON, P SERIES Todos	
R 73		VAN 1 TON, P SERIES Base Exc. Chasis Motorhome	
R 79-89		VAN 3/4 TON, P SERIES Todos	
<b>58377</b>	W		
R 78-79		<b>FORD</b> BRONCO Todos Exc. Kit de Levantamiento	
R 66-77		BRONCO Todos Desde Serie #830001; Exc. Kit de Levantamiento	
R 66-69		PICKUP 1/2 TON, F-100 Todos 4x2 Tracción trasera	
R 65		PICKUP 1/2 TON, F-100 Todos	
R 75-79		PICKUP 1 TON, F-350 / SUPERDUTY Standard Cab Pickup, 4x2 Tracción trasera	
R 75-79		PICKUP 3/4 TON, F-250 / SUPERDUTY Extended Cab Pickup, 4x2 Tracción trasera	
R 70-74		PICKUP 3/4 TON, F-250 / SUPERDUTY 4x2 Tracción trasera Supercab	
R 65-69		PICKUP 3/4 TON, F-250 / SUPERDUTY Todos	
R 76-83		<b>JEEP</b> CHEROKEE Todos	
F 74-83		CHEROKEE Todos	
F 84-91		GRAND WAGONEER Todos	
R 84-91		GRAND WAGONEER Todos	
R 76-83		WAGONEER Todos	
F 74-83		WAGONEER Todos	
<b>58386</b>	W		<b>140780</b>
F 66-77		<b>FORD</b> BRONCO Todos Desde Serie #830001; Exc. Kit de Levantamiento	
F 73-79		PICKUP 1/2 TON, F-100 4x2 Tracción trasera	
F 70-72		PICKUP 1/2 TON, F-100 Todos	
F 66-69		PICKUP 1/2 TON, F-100 Todos 4x2 Tracción trasera	
F 65		PICKUP 1/2 TON, F-100 Todos	
F 75-79		PICKUP 1/2 TON, F-150 4x2 Tracción trasera	
F 75-79		PICKUP 1 TON, F-350 / SUPERDUTY 4x2 Tracción trasera	
F 73-74		PICKUP 1 TON, F-350 / SUPERDUTY Todos 4x2 Tracción trasera; Exc. Supercab	
F 73-79		PICKUP 3/4 TON, F-250 / SUPERDUTY 4x2 Tracción trasera	
F 65-72		PICKUP 3/4 TON, F-250 / SUPERDUTY Todos 4x2 Tracción trasera	
F 77-91		VAN 1 TON, ECONOLINE / CLUB WAGON / SUPERDUTY Todos	
F 75-91		VAN 1 TON, ECONOLINE / CLUB WAGON / SUPERDUTY Todos Exc. Conversión Motorhome	
F 75-91		VAN 3/4 TON, ECONOLINE / CLUB WAGON / SUPERDUTY Todos	
<b>58387</b>	W		<b>140126</b>
R 76-79		<b>FORD</b> PICKUP 1/2 TON, F-150 4x4 Exc. Kit de Levantamiento	
R 75		PICKUP 1/2 TON, F-150 Todos 4x4; Exc. Kit de Levantamiento	

Lista numérica

Amort.	POP	No. Alternativo	Montaje Accesorio
Pos.	Año	Aplicación	
58387	W	-continued	140126
R 79	PICKUP 1 TON, F-350 / SUPERDUTY 4x4		
R 77-79	PICKUP 3/4 TON, F-250 / SUPERDUTY Cab & Chassis, 4x4		
R 77-79	Aplica para toda la serie No. Y20001 PICKUP 3/4 TON, F-250 / SUPERDUTY Standard Cab Pickup, 4x4		
R 77-91	Aplica para toda la serie No. Y20001		
R 77-91	VAN 1 TON, ECONOLINE / CLUB WAGON / SUPERDUTY Todos		
R 75-91	VAN 1 TON, ECONOLINE / CLUB WAGON / SUPERDUTY Todos Exc. Conversión Motorhome		
R 75-91	VAN 3/4 TON, ECONOLINE / CLUB WAGON / SUPERDUTY Todos		
58389	W		
R 81-93	<b>DODGE</b> PICKUP 1/2 TON, W100 SERIES Todos Exc. Kit de Levantamiento		
R 72-80	PICKUP 1/2 TON, W100 SERIES Todos		
R 81-93	PICKUP 1 TON, W300 SERIES Todos Exc. Suspensión Quad y Kit de Levantamiento		
R 72-80	PICKUP 1 TON, W300 SERIES Todos		
R 81-93	PICKUP 3/4 TON, W200 SERIES Standard Cab Pickup Exc. Kit de Levantamiento		
R 72-80	PICKUP 3/4 TON, W200 SERIES Todos		
R 76-93	RAMCHARGER 4x4		
R 76-81	<b>PLYMOUTH</b> TRAILDUSTER 4x4		
58394	W		140702
F 85-99	<b>GMC</b> VAN 1 TON, P SERIES Todos Chasis Motorhome c/ Suspensión Delantera Independiente		
F 75-84	VAN 1 TON, P SERIES Todos Chasis Motorhome		
F 74	VAN 1 TON, P SERIES Motor Home Chasis Motorhome		
58403	W		
R 79-95	<b>CHEVROLET</b> VAN 1 TON, G / EXPRESS Cutaway Van		
R 79-95	<b>GMC</b> VAN 1 TON, G / SAVANNA Cutaway Van		
F 85	VAN 1 TON, P SERIES Todos Chasis Motorhome c/ Eje de Viga Delantera en I		
58406	B		
R 85-96	<b>FORD</b> PICKUP 1/2 TON, F-150 4x2 Tracción trasera		
R 80-97	PICKUP 1 TON, F-350 / SUPERDUTY 4x2 Tracción trasera Exc. Doble Rodada Trasera		
R 97	PICKUP 3/4 TON, F-250 / SUPERDUTY 4x2 Tracción trasera PBV arriba de 8500#		
R 80-96	PICKUP 3/4 TON, F-250 / SUPERDUTY 4x2 Tracción trasera		
58409	W		
R 80-96	<b>FORD</b> BRONCO Todos Exc. Kit de Levantamiento		
R 80-83	PICKUP 1/2 TON, F-100 4x2 Tracción trasera		
R 80-84	PICKUP 1/2 TON, F-150 4x2 Tracción trasera		
R 90-97	PICKUP 1/2 TON, F SUPERDUTY Todos		
R 80-97	PICKUP 1 TON, F-350 / SUPERDUTY 4x2 Tracción trasera Doble Rodada Trasera		
R 97	PICKUP, F-450 SUPERDUTY Todos		
58410	W		141047
F 80-96	<b>FORD</b> BRONCO Todos Suspensión Quad adelante del Eje Delantero; Exc. Kit de Levantamiento		
F 80-96	PICKUP 1/2 TON, F-150 4x4 Suspensión Quad adelante del Eje Delantero; Exc. Kit de Levantamiento		
F 80-81	PICKUP 1 TON, F-350 / SUPERDUTY 4x4		
F 80-82	PICKUP 3/4 TON, F-250 / SUPERDUTY Standard Cab Pickup, 4x4		

Amortiguadores LTV

Amort.	POP	No. Alternativo	Montaje Accesorio
Pos.	Año	Aplicación	
58411	W		
F 77-86	<b>CHEVROLET</b> PICKUP 1 TON, K30 Todos		
F 90-91	PICKUP 1 TON, R3500 Todos		
F 89	PICKUP 1 TON, R3500 Cab & Chassis		
F 89	PICKUP 1 TON, R3500 Crew Cab Pickup		
F 87-88	PICKUP 1 TON, V30 Todos		
F 89-91	PICKUP 1 TON, V3000 / V3500 Todos		
F 77-86	<b>GMC</b> PICKUP 1 TON, K35 / K3500 Todos		
F 87-91	PICKUP 1 TON, V3000 / V3500 Todos		
58412	D		
R 03-07	<b>CHEVROLET</b> CHEYENNE PICKUP 1/2 TON, SILVERADO 1500 Classic Hybrid, 4x4 Classic y Old Body Style; Exc. Suspensión Electrónica Ajustable		
R 07	PICKUP 1/2 TON, SILVERADO 1500 Classic LS, 4x4 Classic y Old Body Style; Exc. Suspensión Electrónica Ajustable		
R 07	PICKUP 1/2 TON, SILVERADO 1500 Classic LT, 4x4 Classic y Old Body Style; Exc. Suspensión Electrónica Ajustable		
R 07	PICKUP 1/2 TON, SILVERADO 1500 Classic WT, 4x4 Classic y Old Body Style; Exc. Suspensión Electrónica Ajustable		
R 99-06	PICKUP 1/2 TON, SILVERADO 1500 4x4 Classic y Old Body Style; Exc. Suspensión Electrónica Ajustable		
R 05-07	PICKUP 1/2 TON, SILVERADO 1500 HD Todos		
R 01-03	PICKUP 1/2 TON, SILVERADO 1500 HD Todos		
R 77-86	PICKUP 1 TON, K30 Todos		
R 90-91	PICKUP 1 TON, R3500 Todos		
R 89	PICKUP 1 TON, R3500 Cab & Chassis		
R 89	PICKUP 1 TON, R3500 Crew Cab Pickup		
R 01-09	PICKUP 1 TON, SILVERADO 3500 Todos		
R 07-10	PICKUP 1 TON, SILVERADO 3500 HD Todos		
R 87-88	PICKUP 1 TON, V30 Todos		
R 89-91	PICKUP 1 TON, V3000 / V3500 Todos		
R 99-08	PICKUP 3/4 TON, SILVERADO 2500 Todos		
R 01-10	PICKUP 3/4 TON, SILVERADO 2500 HD Todos		
R 06-07	<b>DODGE</b> PICKUP 1/2 TON, RAM 1500 Todos Exc. Mega Cab		
R 02-05	PICKUP 1/2 TON, RAM 1500 Todos		
R 77-86	<b>GMC</b> PICKUP 1 TON, K35 / K3500 Todos		
R 87-91	PICKUP 1 TON, V3000 / V3500 Todos		
R 07	SIERRA 1500 Classic Hybrid, 4x4 Classic y Old Body Style; Exc. Suspensión Electrónica Ajustable		
R 07	SIERRA 1500 Classic SL, 4x4 Classic y Old Body Style; Exc. Suspensión Electrónica Ajustable		
R 07	SIERRA 1500 Classic SLE, 4x4 Classic y Old Body Style; Exc. Suspensión Electrónica Ajustable		
R 07	SIERRA 1500 Classic SLT, 4x4 Classic y Old Body Style; Exc. Suspensión Electrónica Ajustable		
R 07	SIERRA 1500 Classic WT, 4x4 Classic y Old Body Style; Exc. Suspensión Electrónica Ajustable		
R 99-06	SIERRA 1500 4x4 Classic y Old Body Style; Exc. Suspensión Electrónica Ajustable		
R 05-07	SIERRA 1500 HD Todos		
R 01-03	SIERRA 1500 HD Todos		
R 99-04	SIERRA 2500 Todos		
R 01-10	SIERRA 2500 HD Todos		
R 01-07	SIERRA 3500 Todos		
R 07-10	SIERRA 3500 HD Todos		
58413	W		
R 78-95	<b>CHEVROLET</b> VAN 1/2 TON, G / EXPRESS Todos		

Lista numérica

Amort.	POP	No. Alternativo	Montaje Accesorio
Pos.	Año	Aplicación	
58413	W	-continued	
R 78-91	VAN 1 TON, G / EXPRESS Standard Cargo Van		
R 78-91	VAN 1 TON, G / EXPRESS Standard Passenger Van		
R 78-95	VAN 3/4 TON, G / EXPRESS Todos Exc. PBV 8600 #		
R 99-03	<b>DODGE</b> VAN 1/2 TON, A / B SERIES / RAM 109.3 (WheelBase) Exc. PBV 7000#		
R 81-98	VAN 1/2 TON, A / B SERIES / RAM 109.6 (WheelBase) Exc. PBV 7000#		
R 71-80	VAN 1/2 TON, A / B SERIES / RAM Todos		
R 99-03	VAN 1 TON, A / B SERIES / RAM Todos		
R 95-98	VAN 1 TON, A / B SERIES / RAM Todos Exc. Eje Delantero 4000#		
R 71-94	VAN 1 TON, A / B SERIES / RAM Todos		
R 71-03	VAN 3/4 TON, A / B SERIES / RAM Todos		
R 74-80	VAN, CB300 Todos		
R 78-95	<b>GMC</b> VAN 1/2 TON, G / SAVANNA Todos		
R 85-96	VAN 1 TON, G / SAVANNA Extended Cargo Van		
R 85-96	VAN 1 TON, G / SAVANNA Extended Passenger Van		
R 79-96	VAN 1 TON, G / SAVANNA Standard Cargo Van		
R 79-96	VAN 1 TON, G / SAVANNA Standard Passenger Van		
R 78	VAN 1 TON, G / SAVANNA Cutaway Van		
R 78-95	VAN 3/4 TON, G / SAVANNA Todos Exc. PBV 8600 #		
R 74-83	<b>PLYMOUTH</b> VAN 1/2 TON, PB SERIES Todos		
R 74-83	VAN 1 TON, PB SERIES Todos		
R 74-83	VAN 3/4 TON, PB SERIES Todos		
58414	B		140780
F 80-96	<b>FORD</b> BRONCO Todos Con o sin Suspensión Quad detrás del Eje Delantero; Exc. Kit de Levantamiento		
F 80-83	PICKUP 1/2 TON, F-100 4x2 Tracción trasera		
F 80-96	PICKUP 1/2 TON, F-150 4x4 Con o sin Suspensión Quad detrás del Eje Delantero; Exc. Kit de Levantamiento		
F 80-96	PICKUP 1/2 TON, F-150 4x2 Tracción trasera		
F 80-97	PICKUP 1 TON, F-350 / SUPERDUTY 4x2 Tracción trasera		
F 97	PICKUP 3/4 TON, F-250 / SUPERDUTY 4x2 Tracción trasera PBV arriba de 8500#		
F 80-96	PICKUP 3/4 TON, F-250 / SUPERDUTY 4x2 Tracción trasera		
58416	W		140780
F 82-85	<b>FORD</b> PICKUP 1 TON, F-350 / SUPERDUTY 4x4 Montaje Inferior Delantero Tipo Abrazadera Exc. Doble Rodado o Kit de Levantamiento		
F 83-86	PICKUP 3/4 TON, F-250 / SUPERDUTY 4x4 Montaje Inferior Delantero Tipo Abrazadera Exc. Doble Rodado o Kit de Levantamiento		
F 80-82	PICKUP 3/4 TON, F-250 / SUPERDUTY Extended Cab Pickup, 4x4		
58421	W		140455
F 05	<b>CHEVROLET</b> BLAZER Base, 4x2 Tracción trasera		
F 96-04	BLAZER LS, 4x2 Tracción trasera		
F 95-02	BLAZER LT, 4x2 Tracción trasera		
F 95-99	BLAZER Base, 4x2 Tracción trasera		
F 95-97	BLAZER Deluxe, 4x2 Tracción trasera		
F 83-94	BLAZER, S MODELS 4x2 Tracción trasera		
F 94-03	S10 LS, 4x2 Tracción trasera		
F 82-03	S10 Base, 4x2 Tracción trasera		
F 92-93	S10 EL, 4x2 Tracción trasera		
F 83-92	S10 Tahoe, 4x2 Tracción trasera		
F 88-90	S10 Durango, 4x2 Tracción trasera		
F 82-86	S10 Durango, 4x2 Tracción trasera		
F 92-04	<b>GMC</b> JIMMY 4x2 Tracción trasera		

Lista numérica

Amort.	POP	No. Alternativo	Montaje Accesorio
Pos.	Año	Aplicación	
<b>58421</b>	W	-continued	140455
F	83-91	S15 JIMMY 4x2 Tracción trasera	
F	04	SONOMA / S15 Todos 4x2 Tracción trasera	
F	82-03	SONOMA / S15 4x2 Tracción trasera	
F	72-76	MAZDA B1600 Todos	
F	77-78	B1800 Todos	
F	79-84	B2000 Todos	
F	82-84	B2200 Todos	
<b>58422</b>	W		
R	05	<b>CHEVROLET</b> BLAZER Base, 4x4	
R	05	BLAZER Base, 4x2 Tracción trasera	
R	96-04	BLAZER LS, 4x4	
R	96-04	BLAZER LS, 4x2 Tracción trasera	
R	95-02	BLAZER LT, 4x2 Tracción trasera	
R	95-01	BLAZER LT, 4x4	
R	95-99	BLAZER Base, 4x4	
R	95-99	BLAZER Base, 4x2 Tracción trasera	
R	95-97	BLAZER Deluxe, 4x2 Tracción trasera	
R	83-94	BLAZER, S MODELS Todos	
R	99-04	S10 LS, 4x4	
R	99-03	S10 Base, 4x4	
R	99-03	S10 Base, 4x2 Tracción trasera	
R	99-03	S10 LS, 4x2 Tracción trasera	
R	94-98	S10 LS	
R	82-98	S10 Base	
R	92-93	S10 EL	
R	83-92	S10 Tahoe	
R	88-90	S10 Durango	
R	82-86	S10 Durango	
R	92-05	<b>GMC</b> JIMMY Todos	
R	83-91	S15 JIMMY Todos	
R	82-04	SONOMA / S15 Todos	
R	91	SYCLONE Todos	
R	92-93	TYPHOON Todos	
<b>58423</b>	W		
F	05	<b>CHEVROLET</b> BLAZER Base, 4x4	
F	96-04	BLAZER LS, 4x4	
F	95-01	BLAZER LT, 4x4	
F	95-99	BLAZER Base, 4x4	
F	83-94	BLAZER, S MODELS 4x4	
F	94-04	S10 LS, 4x4	
F	83-03	S10 Base, 4x4	
F	92-93	S10 EL, 4x4	
F	83-92	S10 Tahoe, 4x4	
F	88-90	S10 Durango, 4x4	
F	88	S10 Sport, 4x4	
F	83-86	S10 Durango, 4x4	
F	92-05	<b>GMC</b> JIMMY 4x4	
F	83-91	S15 JIMMY 4x4	
F	83-04	SONOMA / S15 4x4	
F	91	SYCLONE Todos	
F	92-93	TYPHOON Todos	
<b>58437</b>	W		
F	87-91	<b>CHEVROLET</b> BLAZER 4x4 Automóvil Grande; Kit de Levantamiento de 4"; Exc. Suspensión Quad	
F	73-86	BLAZER 4x4 Con Kit de Levantamiento de 4"; Exc. Suspensión Quad	
F	73-86	PICKUP 1/2 TON, K10 Todos Con Kit de Levantamiento de 4"; Exc. Suspensión Quad	
F	87	PICKUP 1/2 TON, V10 Todos Con Kit de Levantamiento de 4"; Exc. Suspensión Quad	
F	73-86	PICKUP 3/4 TON, K20 Todos Con Kit de Levantamiento de 4"; Exc. Suspensión Quad	
F	87	PICKUP 3/4 TON, V20 Todos Con Kit de Levantamiento de 4"; Exc. Suspensión Quad	
F	73-86	PICKUP 1/2 TON, K15 / K1500 Todos Con Kit de Levantamiento de 4"; Exc. Suspensión Quad	
F	89-91	SUBURBAN 1/2 TON, V1500 4x4 Con Kit de Levantamiento de 4"; Exc. Suspensión Quad	
F	73-86	SUBURBAN 3/4 TON, K20 Todos Con Kit de Levantamiento de 4"; Exc. Suspensión Quad	
F	87-88	SUBURBAN 3/4 TON, V20 Todos Con Kit de Levantamiento de 4"; Exc. Suspensión Quad	
F	89-91	SUBURBAN 3/4 TON, V2500 Todos Con Kit de Levantamiento de 4"; Exc. Suspensión Quad	
F	75-91	<b>GMC</b> JIMMY 4x4 Con Kit de Levantamiento de 4"; Exc. Suspensión Quad	

Amortiguadores LTV

Amort.	POP	No. Alternativo	Montaje Accesorio
Pos.	Año	Aplicación	
<b>58437</b>	W	-continued	
F	73-74	JIMMY Todos Con Kit de Levantamiento de 4"; Exc. Suspensión Quad	
F	73-86	PICKUP 1/2 TON, K15 / K1500 Todos Con Kit de Levantamiento de 4"; Exc. Suspensión Quad	
F	87	PICKUP 1/2 TON, V1500 Todos Con Kit de Levantamiento de 4"; Exc. Suspensión Quad	
F	73-86	PICKUP 3/4 TON, K25 / K2500 Todos Con Kit de Levantamiento de 4"; Exc. Suspensión Quad	
F	87	PICKUP 3/4 TON, V2500 Todos Con Kit de Levantamiento de 4"; Exc. Suspensión Quad	
F	73-86	SUBURBAN 1/2 TON, K15 / K1500 Todos Con Kit de Levantamiento de 4"; Exc. Suspensión Quad	
F	87-91	SUBURBAN 1/2 TON, V1500 Todos Con Kit de Levantamiento de 4"; Exc. Suspensión Quad	
F	73-86	SUBURBAN 3/4 TON, K25 / K2500 Todos Con Kit de Levantamiento de 4"; Exc. Suspensión Quad	
F	87-91	SUBURBAN 3/4 TON, V2500 Todos Con Kit de Levantamiento de 4"; Exc. Suspensión Quad	
<b>58438</b>	W	140357	
R	87-90	<b>CHEVROLET</b> BLAZER 4x4 Automóvil Grande; Kit de Levantamiento de 4"; Exc. Suspensión Quad	
R	73-86	BLAZER 4x4 Con Kit de Levantamiento de 4"; Exc. Suspensión Quad	
R	73-86	PICKUP 1/2 TON, K10 Todos Con Kit de Levantamiento de 4"; Exc. Suspensión Quad	
R	87	PICKUP 1/2 TON, V10 Todos Con Kit de Levantamiento de 4"; Exc. Suspensión Quad	
R	73-86	PICKUP 3/4 TON, K20 Todos Con Kit de Levantamiento de 4"; Exc. Suspensión Quad	
R	87	PICKUP 3/4 TON, V20 Todos Con Kit de Levantamiento de 4"; Exc. Suspensión Quad	
R	73-86	SUBURBAN 1/2 TON, K10 Todos Con Kit de Levantamiento de 4"; Exc. Suspensión Quad	
R	73-86	SUBURBAN 3/4 TON, K20 Todos Con Kit de Levantamiento de 4"; Exc. Suspensión Quad	
R	87-88	SUBURBAN 3/4 TON, V20 Todos Con Kit de Levantamiento de 4"; Exc. Suspensión Quad	
R	89-91	SUBURBAN 3/4 TON, V2500 Todos Con Kit de Levantamiento de 4"; Exc. Suspensión Quad	
R	85-91	<b>GMC</b> JIMMY Todos Con Kit de Levantamiento de 4"; Exc. Suspensión Quad	
R	75-84	JIMMY 4x4 Con Kit de Levantamiento de 4"; Exc. Suspensión Quad	
R	73-74	JIMMY Todos Con Kit de Levantamiento de 4"; Exc. Suspensión Quad	
R	73-86	PICKUP 1/2 TON, K15 / K1500 Todos Con Kit de Levantamiento de 4"; Exc. Suspensión Quad	
R	87	PICKUP 1/2 TON, V1500 Todos Con Kit de Levantamiento de 4"; Exc. Suspensión Quad	
R	73-86	PICKUP 3/4 TON, K25 / K2500 Todos Con Kit de Levantamiento de 4"; Exc. Suspensión Quad	
R	87	PICKUP 3/4 TON, V2500 Todos Con Kit de Levantamiento de 4"; Exc. Suspensión Quad	
R	73-86	SUBURBAN 1/2 TON, K15 / K1500 Todos Con Kit de Levantamiento de 4"; Exc. Suspensión Quad	
R	87-91	SUBURBAN 1/2 TON, V1500 Todos Con Kit de Levantamiento de 4"; Exc. Suspensión Quad	
R	73-86	SUBURBAN 3/4 TON, K25 / K2500 Todos Con Kit de Levantamiento de 4"; Exc. Suspensión Quad	
R	87-91	SUBURBAN 3/4 TON, V2500 Todos Con Kit de Levantamiento de 4"; Exc. Suspensión Quad	

Lista numérica

Amort.	POP	No. Alternativo	Montaje Accesorio
Pos.	Año	Aplicación	
<b>58455</b>	W		
F	86-97	<b>FORD</b> PICKUP 1 TON, F-350 / SUPERDUTY 4x4	
F	97	PICKUP 3/4 TON, F-250 / SUPERDUTY 4x4 PBV arriba de 8500#	
F	87-96	PICKUP 3/4 TON, F-250 / SUPERDUTY 4x4	
<b>58456</b>	W		
R	86-97	<b>FORD</b> PICKUP 1 TON, F-350 / SUPERDUTY 4x4 Exc. Doble Rodada Trasera	
<b>58461</b>	W		
R	80-96	<b>FORD</b> PICKUP 1/2 TON, F-150 4x4 Exc. Kit de Levantamiento	
R	86-97	PICKUP 1 TON, F-350 / SUPERDUTY 4x4 Doble Rodada Trasera	
R	82-85	PICKUP 1 TON, F-350 / SUPERDUTY 4x4 Montaje Inferior Delantero Tipo Abrazadera Exc. Doble Rodado o Kit de Levantamiento	
R	80-81	PICKUP 1 TON, F-350 / SUPERDUTY 4x4 Doble Rodada Trasera	
R	97	PICKUP 3/4 TON, F-250 / SUPERDUTY 4x4 PBV arriba de 8500#	
R	86-96	PICKUP 3/4 TON, F-250 / SUPERDUTY 4x4	
R	82-85	PICKUP 3/4 TON, F-250 / SUPERDUTY 4x4 Montaje Inferior Delantero Tipo Abrazadera Exc. Doble Rodado o Kit de Levantamiento	
R	80-81	PICKUP 3/4 TON, F-250 / SUPERDUTY 4x4	
<b>58488</b>	W		
R	88-99	<b>CHEVROLET</b> PICKUP 1/2 TON, C15 / C1500 Todos	
R	88-99	PICKUP 1/2 TON, K15 / K1500 Todos	
R	01-03	PICKUP 1 TON, C35/3500 HD, Standard Cab Pickup Eje Delantero Rígido HD	
R	88-00	PICKUP 1 TON, C35/3500 Standard Cab Pickup Eje Delantero Rígido HD	
R	88-90	PICKUP 1 TON, C35/3500 Extended Cab Pickup Eje Delantero Rígido HD	
R	88-00	PICKUP 1 TON, K35 / K3500 Todos	
R	88-00	PICKUP 3/4 TON, C25 / C2500 Todos	
R	88-00	PICKUP 3/4 TON, K25 / K2500 Todos	
R	88-99	<b>GMC</b> PICKUP 1/2 TON, C15 / C1500 Todos	
R	88-99	PICKUP 1/2 TON, K15 / K1500 Todos	
R	98-00	PICKUP 1 TON, C35/3500 Cab & Chassis Eje Delantero Rígido HD	
R	88-97	PICKUP 1 TON, C35/3500 Todos Eje Delantero Rígido HD	
R	88-00	PICKUP 1 TON, K35 / K3500 Todos	
R	88-00	PICKUP 3/4 TON, C25 / C2500 Todos	
R	88-00	PICKUP 3/4 TON, K25 / K2500 Todos	
<b>58489</b>	W	141537	
F	88-99	<b>CHEVROLET</b> PICKUP 1/2 TON, C15 / C1500 Todos	
F	92-00	PICKUP 1 TON, C35/3500 Crew Cab Pickup Eje Delantero Rígido HD	
F	88-00	PICKUP 1 TON, C35/3500 Extended Cab Pickup Eje Delantero Rígido HD	
F	88-00	PICKUP 1 TON, C35/3500 Standard Cab Pickup Eje Delantero Rígido HD	
F	88-00	PICKUP 3/4 TON, C25 / C2500 Todos	
F	92-99	SUBURBAN 1/2 TON, C15 / C1500 Todos	
F	92-99	SUBURBAN 3/4 TON, C25 / C2500 Todos	
F	95-00	TAHOE 4x2 Tracción trasera Old Body Style	
F	88-99	<b>GMC</b> PICKUP 1/2 TON, C15 / C1500 Todos	
F	92-00	PICKUP 1 TON, C35/3500 Crew Cab Pickup Eje Delantero Rígido HD	
F	88-00	PICKUP 1 TON, C35/3500 Extended Cab Pickup Eje Delantero Rígido HD	



Lista numérica

Amort.	POP	No. Alternativo	Montaje Accesorio
Pos.	Año	Aplicación	
<b>58489</b>	W	-continued	141537
F	88-00	PICKUP 1 TON, C35/3500 Standard Cab Pickup Eje Delantero Rígido HD	
F	88-00	PICKUP 3/4 TON, C25 / C2500 Todos	
F	92-99	SUBURBAN 1/2 TON, C15 / C1500 Todos	
F	92-99	SUBURBAN 3/4 TON, C25 / C2500 Todos	
F	92-99	YUKON 4x2 Tracción trasera	
<b>58500</b>	W		140780
F	75-91	FORD VAN 1/2 TON, ECONOLINE / CLUB WAGON Todos	
<b>58609</b>	W		
F	99-00	CADILLAC ESCALADE Todos	
F	90-05	CHEVROLET ASTRO AWD	
F	92-94	BLAZER 4x4 Automóvil Grande	
F	88-00	PICKUP 1 TON, K35 / K3500 Todos	
F	88-00	PICKUP 3/4 TON, K25 / K2500 Todos	
F	92-99	SUBURBAN 1/2 TON, K15 / K1500 Todos	
F	92-99	SUBURBAN 3/4 TON, K25 / K2500 Todos	
F	88-00	GMC PICKUP 1 TON, K35 / K3500 Todos	
F	88-00	PICKUP 3/4 TON, K25 / K2500 Todos	
F	90-05	SAFARI AWD	
F	92-99	SUBURBAN 1/2 TON, K15 / K1500 Todos	
F	92-99	SUBURBAN 3/4 TON, K25 / K2500 Todos	
<b>58617</b>	W		
F	90-93	FORD PICKUP 1/2 TON, F SUPERDUTY Todos Fab. hasta 2/93	
<b>58622</b>	D		142617
F	04-11	FORD VAN 1 TON, ECONOLINE / CLUB WAGON / SUPERDUTY Todos Exc. Paquete de Ambulancia & Manejo	
F	07-08	VAN 1 TON, ECONOLINE / CLUB WAGON / SUPERDUTY Todos Conversión a Motorhome	
F	92-05	VAN 1 TON, ECONOLINE / CLUB WAGON / SUPERDUTY Todos Conversión a Motorhome	
F	92-11	VAN 3/4 TON, ECONOLINE / CLUB WAGON / SUPERDUTY Todos	
<b>58623</b>	W		142617
R	04-11	FORD VAN 1 TON, ECONOLINE / CLUB WAGON / SUPERDUTY Todos Exc. Paquete de Ambulancia & Manejo	
R	07-08	VAN 1 TON, ECONOLINE / CLUB WAGON / SUPERDUTY Todos Conversión a Motorhome	
R	92-05	VAN 1 TON, ECONOLINE / CLUB WAGON / SUPERDUTY Todos Conversión a Motorhome	
R	92-11	VAN 3/4 TON, ECONOLINE / CLUB WAGON / SUPERDUTY Todos	
<b>58624</b>	W		140780
R	92-11	FORD VAN 1/2 TON, ECONOLINE / CLUB WAGON Todos	
<b>58625</b>	W		
F	86-99	GMC VAN 1 TON, P SERIES Todos Chasis Motorhome c/ Eje de Viga Delantero en I	
<b>58638</b>	W		
R	99-00	CADILLAC ESCALADE Todos	
R	92-94	CHEVROLET BLAZER 4x4 Automóvil Grande	
R	92-99	SUBURBAN 1/2 TON, C15 / C1500 Todos	
R	92-99	SUBURBAN 1/2 TON, K15 / K1500 Todos	
R	92-99	SUBURBAN 3/4 TON, C25 / C2500 Todos	
R	92-99	SUBURBAN 3/4 TON, K25 / K2500 Todos	
R	95-00	TAHOE Todos Old Body Style	
R	96-11	VAN 1/2 TON, G / EXPRESS Todos	
R	10-12	VAN 1 TON, G / EXPRESS Todos	
R	03-06	VAN 1 TON, G / EXPRESS Todos	
R	07-09	VAN 3/4 TON, G / EXPRESS Todos	
R	96-02	VAN 3/4 TON, G / EXPRESS Todos Exc. PBV 8600 #	

Amortiguadores LTV

Amort.	POP	No. Alternativo	Montaje Accesorio
Pos.	Año	Aplicación	
<b>58638</b>	W	-continued	
R	92-99	GMC SUBURBAN 1/2 TON, C15 / C1500 Todos	
R	92-99	SUBURBAN 1/2 TON, K15 / K1500 Todos	
R	92-99	SUBURBAN 3/4 TON, C25 / C2500 Todos	
R	92-99	SUBURBAN 3/4 TON, K25 / K2500 Todos	
R	08-11	VAN 1/2 TON, G / SAVANNA Todos	
R	96-06	VAN 1/2 TON, G / SAVANNA Todos	
R	96-02	VAN 1 TON, G / SAVANNA Todos Exc. PBV 8600 #	
R	96-02	VAN 3/4 TON, G / SAVANNA Todos Exc. PBV 8600 #	
R	92-99	YUKON Todos	
R	99	YUKON Denali	
<b>58661</b>	W		143000
F	94-01	DODGE PICKUP 1/2 TON, RAM 1500 4x2 Tracción trasera	
F	94-02	PICKUP 1 TON, RAM 3500 4x2 Tracción trasera Exc. Eje Delantero Rígido	
F	94-02	PICKUP 3/4 TON, RAM 2500 4x2 Tracción trasera	
<b>58662</b>	W		
R	03-07	CHEVROLET CHEYENNE PICKUP 1/2 TON, SILVERADO 1500 Classic Hybrid, 4x2 Tracción trasera	
R	07	PICKUP 1/2 TON, SILVERADO 1500 Classic LS, 4x2 Tracción trasera	
R	07	PICKUP 1/2 TON, SILVERADO 1500 Classic LT, 4x2 Tracción trasera	
R	07	PICKUP 1/2 TON, SILVERADO 1500 Classic SS, 4x2 Tracción trasera	
R	07	PICKUP 1/2 TON, SILVERADO 1500 Classic WT, 4x2 Tracción trasera	
R	99-06	PICKUP 1/2 TON, SILVERADO 1500 4x2 Tracción trasera Exc. Suspensión Electrónica Ajustable	
R	94-01	DODGE PICKUP 1/2 TON, RAM 1500 Todos	
R	94-02	PICKUP 1 TON, RAM 3500 4x2 Tracción trasera Exc. Eje Delantero Rígido	
R	94-02	PICKUP 3/4 TON, RAM 2500 4x4, GAS Exc. PBV 8600 #	
R	94-02	PICKUP 3/4 TON, RAM 2500 4x2 Tracción trasera	
R	95-96	PICKUP 3/4 TON, RAM 2500 4x4, CNG Exc. PBV 8600 #	
R	07	GMC SIERRA 1500 Classic Hybrid, 4x2 Tracción trasera Exc. Suspensión Electrónica Ajustable	
R	07	SIERRA 1500 Classic SL, 4x2 Tracción trasera Exc. Suspensión Electrónica Ajustable	
R	07	SIERRA 1500 Classic SLE, 4x2 Tracción trasera Exc. Suspensión Electrónica Ajustable	
R	07	SIERRA 1500 Classic SLT, 4x2 Tracción trasera Exc. Suspensión Electrónica Ajustable	
R	07	SIERRA 1500 Classic WT, 4x2 Tracción trasera Exc. Suspensión Electrónica Ajustable	
R	99-06	SIERRA 1500 4x2 Tracción trasera Exc. Suspensión Electrónica Ajustable	
<b>58671</b>	W		
R	92-96	CHEVROLET VAN 1 TON, G / EXPRESS Todos Chassis Cab	
R	92-96	GMC VAN 1 TON, G / SAVANNA Todos Chassis Cab	
<b>58673</b>	W		142731
F	94-01	DODGE PICKUP 1/2 TON, RAM 1500 4x4	
F	94-02	PICKUP 3/4 TON, RAM 2500 4x4, GAS Exc. PBV 8600 #	
F	95-96	PICKUP 3/4 TON, RAM 2500 4x4, CNG Exc. PBV 8600 #	
<b>58674</b>	W		142731
F	94-02	DODGE PICKUP 1 TON, RAM 3500 4x4	

Lista numérica

Amort.	POP	No. Alternativo	Montaje Accesorio
Pos.	Año	Aplicación	
<b>58674</b>	W	-continued	142731
F	94-02	PICKUP 1 TON, RAM 3500 4x2 Tracción trasera Eje Delantero Rígido	
F	94-02	PICKUP 3/4 TON, RAM 2500 4x4, DIESEL PBV 8800	
<b>58675</b>	W		
R	94-02	DODGE PICKUP 1 TON, RAM 3500 4x4	
R	94-02	PICKUP 1 TON, RAM 3500 4x2 Tracción trasera Eje Delantero Rígido	
R	94-02	PICKUP 3/4 TON, RAM 2500 4x4, DIESEL PBV 8800	
<b>58714</b>	C		142731
F	97-02	FORD EXPEDITION 4x2 Tracción trasera Exc. Nivelación Neumática Delantera	
F	97-04	PICKUP 1/2 TON, F-150 4x2 Tracción trasera	
F	96-99	PICKUP 3/4 TON, F-250 / SUPERDUTY 4x2 Tracción trasera Hasta PBV 8500#	
F	98-02	LINCOLN NAVIGATOR 4x2 Tracción trasera	
<b>58715</b>	W		142700
R	97-04	FORD PICKUP 1/2 TON, F-150 4x4 Exc. PBV 7700#	
R	97-99	PICKUP 3/4 TON, F-250 / SUPERDUTY 4x4 Hasta PBV 8500#, Exc. Superduty	
<b>58716</b>	D		142731
F	97-02	FORD EXPEDITION 4x4 Exc. Nivelación Neumática Delantera	
F	04	PICKUP 1/2 TON, F-150 4x4 Exc. PBV 7700#	
F	97-03	PICKUP 1/2 TON, F-150 4x4	
F	97-99	PICKUP 3/4 TON, F-250 / SUPERDUTY 4x4 Hasta PBV 8500#, Exc. Superduty	
<b>58717</b>	D		
R	97-02	FORD EXPEDITION Todos	
R	98-02	LINCOLN NAVIGATOR 4x2 Tracción trasera, Coil (FrontSpringType)	
<b>58778</b>	W		142700
R	04	FORD PICKUP 1/2 TON, F-150 4x2 Tracción trasera	
R	00-03	PICKUP 1/2 TON, F-150 Harley-Davidson Edition, 4x2 Tracción trasera	
R	99-03	PICKUP 1/2 TON, F-150 Lariat, 4x2 Tracción trasera	
R	99-03	PICKUP 1/2 TON, F-150 XL, 4x2 Tracción trasera	
R	99-03	PICKUP 1/2 TON, F-150 XLT, 4x2 Tracción trasera	
R	00	PICKUP 1/2 TON, F-150 Base, 4x2 Tracción trasera	
R	97-98	PICKUP 1/2 TON, F-150 4x2 Tracción trasera	
R	97-99	PICKUP 3/4 TON, F-250 / SUPERDUTY 4x2 Tracción trasera Hasta PBV 8500#	
<b>58783</b>	W		141665
F	03-07	CHEVROLET CHEYENNE PICKUP 1/2 TON, SILVERADO 1500 Classic Hybrid, 4x2 Tracción trasera	
F	07	PICKUP 1/2 TON, SILVERADO 1500 Classic LS, 4x2 Tracción trasera	
F	07	PICKUP 1/2 TON, SILVERADO 1500 Classic LT, 4x2 Tracción trasera	
F	07	PICKUP 1/2 TON, SILVERADO 1500 Classic SS, 4x2 Tracción trasera	
F	07	PICKUP 1/2 TON, SILVERADO 1500 Classic WT, 4x2 Tracción trasera	
F	99-06	PICKUP 1/2 TON, SILVERADO 1500 4x2 Tracción trasera Susp. Elec. Ajustable	
F	07	GMC SIERRA 1500 Classic Hybrid, 4x2 Tracción trasera Exc. Suspensión Electrónica Ajustable	

Lista numérica

Amort.	POP	No. Alternativo	Montaje Accesorio
Pos.	Año	Aplicación	
<b>58783</b>	W	-continued	141665
F 07	SIERRA 1500 Classic SL, 4x2	Tracción trasera Exc. Suspensión Electrónica Ajustable	
F 07	SIERRA 1500 Classic SLE, 4x2	Tracción trasera Exc. Suspensión Electrónica Ajustable	
F 07	SIERRA 1500 Classic SLT, 4x2	Tracción trasera Exc. Suspensión Electrónica Ajustable	
F 07	SIERRA 1500 Classic WT, 4x2	Tracción trasera Exc. Suspensión Electrónica Ajustable	
F 99-06	SIERRA 1500 4x2	Tracción trasera Exc. Suspensión Electrónica Ajustable	
<b>58803</b>	D		141665
F 02-06	<b>CHEVROLET AVALANCHE 1500</b>	Todos Exc. Control de Manejo Electrónico	
F 03-07	CHEYENNE	PICKUP 1/2 TON, SILVERADO 1500 Classic Hybrid, 4x4 Classic y Old Body Style; Exc. Suspensión Electrónica Ajustable	
F 07	PICKUP 1/2 TON, SILVERADO	1500 Classic LS, 4x4 Classic y Old Body Style; Exc. Suspensión Electrónica Ajustable	
F 07	PICKUP 1/2 TON, SILVERADO	1500 Classic LT, 4x4 Classic y Old Body Style; Exc. Suspensión Electrónica Ajustable	
F 07	PICKUP 1/2 TON, SILVERADO	1500 Classic WT, 4x4 Classic y Old Body Style; Exc. Suspensión Electrónica Ajustable	
F 99-06	PICKUP 1/2 TON, SILVERADO	1500 4x4 Classic y Old Body Style; Exc. Suspensión Electrónica Ajustable	
F 00-06	SUBURBAN 1/2 TON, 1500	Todos Exc. Suspensión Z55 Auto Ride	
F 02-06	TAHOE	Todos Exc. Suspensión Z55 Auto Ride	
F 00-01	TAHOE	Todos Estilo New Body, Exc. Suspensión Z55	
F 07	<b>GMC SIERRA 1500 Classic Hybrid,</b>	4x4 Classic y Old Body Style; Exc. Suspensión Electrónica Ajustable	
F 07	SIERRA 1500 Classic SL, 4x4	Classic y Old Body Style; Exc. Suspensión Electrónica Ajustable	
F 07	SIERRA 1500 Classic SLE, 4x4	Classic y Old Body Style; Exc. Suspensión Electrónica Ajustable	
F 07	SIERRA 1500 Classic SLT, 4x4	Classic y Old Body Style; Exc. Suspensión Electrónica Ajustable	
F 07	SIERRA 1500 Classic WT, 4x4	Classic y Old Body Style; Exc. Suspensión Electrónica Ajustable	
F 99-06	SIERRA 1500 4x4	Classic y Old Body Style; Exc. Suspensión Electrónica Ajustable	
F 00-06	YUKON	Todos Exc. Suspensión Z55 Auto Ride	
F 00-06	YUKON XL 1/2 TON	Todos Exc. Suspensión Z55 Auto Ride	
<b>58807</b>	B		142617
F 99-12	<b>FORD PICKUP 1 TON, F-350 /</b>	SUPERDUTY 4x2 Tracción trasera	
F 99-12	PICKUP 3/4 TON, F-250 /	SUPERDUTY 4x2 Tracción trasera	
<b>58808</b>	C		
R 99-04	<b>FORD PICKUP 1 TON, F-350 /</b>	SUPERDUTY 4x2 Tracción trasera	
R 99-04	PICKUP 3/4 TON, F-250 /	SUPERDUTY 4x2 Tracción trasera	
<b>58809</b>	C		
F 99-04	<b>FORD PICKUP 1 TON, F-350 /</b>	SUPERDUTY 4x4	
F 99-04	PICKUP 3/4 TON, F-250 /	SUPERDUTY 4x4	
F 99-04	PICKUP, F-450	SUPERDUTY Todos	
F 99-04	PICKUP, F-550	SUPERDUTY Todos	
<b>58810</b>	D		
R 99-04	<b>FORD PICKUP 1 TON, F-350 /</b>	SUPERDUTY 4x4	
R 99-04	PICKUP 3/4 TON, F-250 /	SUPERDUTY 4x4	

Amortiguadores LTV

Amort.	POP	No. Alternativo	Montaje Accesorio
Pos.	Año	Aplicación	
<b>58811</b>	D		
R 99-04	<b>FORD PICKUP, F-450 SUPERDUTY</b>	Todos	
R 99-04	PICKUP, F-550	SUPERDUTY Todos	
<b>58812</b>	W		
F 91-00	<b>CHEVROLET PICKUP 1 TON,</b>	C35/3500 Cab & Chassis Eje Delantero Rígido HD	
F 91-00	<b>GMC PICKUP 1 TON, C35/3500</b>	Cab & Chassis Eje Delantero Rígido HD	
<b>58817</b>	D		141665
F 02-06	<b>CHEVROLET AVALANCHE 2500</b>	Todos Exc. Control de Manejo Electrónico	
F 05-07	PICKUP 1/2 TON, SILVERADO	1500 HD Todos	
F 01-03	PICKUP 1/2 TON, SILVERADO	1500 HD Todos	
F 01-09	PICKUP 1 TON, SILVERADO	3500 Todos	
F 07-10	PICKUP 1 TON, SILVERADO	3500 HD Todos	
F 05-08	PICKUP 3/4 TON, SILVERADO	2500 Todos	
F 99-04	PICKUP 3/4 TON, SILVERADO	2500 4x4	
F 01-10	PICKUP 3/4 TON, SILVERADO	2500 HD Todos PBV 9200	
F 00-11	SUBURBAN 3/4 TON, 2500	Todos Exc. Suspensión Auto Ride Z55 y QuadraSteer	
F 05-07	<b>GMC SIERRA 1500 HD</b>	Todos	
F 01-03	SIERRA 1500 HD	Todos	
F 99-04	SIERRA 2500	Todos	
F 01-10	SIERRA 2500 HD	Todos	
F 01-07	SIERRA 3500	Todos	
F 07-10	SIERRA 3500 HD	Barra de Torsion (FrontSpringType)	
F 00-06	YUKON XL 3/4 TON	Todos Exc. Sistema de Autonivelación NIVOMAT	
<b>58901</b>	W		
F 88-99	<b>CHEVROLET PICKUP 1/2 TON,</b>	K15 / K1500 Todos	
F 95-00	TAHOE 4x4	Old Body Style	
F 88-99	<b>GMC PICKUP 1/2 TON, K15 / K1500</b>	Todos	
F 92-99	YUKON 4x4		
F 99	YUKON	Denali	
<b>58906</b>	W		
F 87-91	<b>CHEVROLET BLAZER 4x4</b>	Automóvil Grande; Suspensión Quad Amortiguador Largo; Exc. Kit de Levantamiento	
F 81-86	BLAZER 4x4	Suspensión Quad Amortiguador Largo; Exc. Kit de Levantamiento	
F 81-86	PICKUP 1/2 TON, K10	Todos Suspensión Quad Amortiguador Largo; Exc. Kit de Levantamiento	
F 87	PICKUP 1/2 TON, V10	Todos Suspensión Quad Amortiguador Largo; Exc. Kit de Levantamiento	
F 81-86	PICKUP 3/4 TON, K20	Todos Suspensión Quad Amortiguador Largo; Exc. Kit de Levantamiento	
F 87	PICKUP 3/4 TON, V20	Todos Suspensión Quad Amortiguador Largo; Exc. Kit de Levantamiento	
F 81-86	SUBURBAN 1/2 TON, K10	Todos Suspensión Quad Amortiguador Largo; Exc. Kit de Levantamiento	
F 81-86	SUBURBAN 3/4 TON, K20	Todos Suspensión Quad Amortiguador Largo; Exc. Kit de Levantamiento	
F 87-88	SUBURBAN 3/4 TON, V20	Todos Suspensión Quad Amortiguador Largo; Exc. Kit de Levantamiento	
F 89-91	SUBURBAN 3/4 TON, V2500	Todos Suspensión Quad Amortiguador Largo; Exc. Kit de Levantamiento	
F 73-91	<b>GMC JIMMY 4x4</b>	Suspensión Quad Amortiguador Largo; Exc. Kit de Levantamiento	
F 81-86	PICKUP 1/2 TON, K15 / K1500	Todos Suspensión Quad Amortiguador Largo; Exc. Kit de Levantamiento	
F 87	PICKUP 1/2 TON, V1500	Todos Suspensión Quad Amortiguador Largo; Exc. Kit de Levantamiento	

Lista numérica

Amort.	POP	No. Alternativo	Montaje Accesorio
Pos.	Año	Aplicación	
<b>58906</b>	W	-continued	
F 81-86	PICKUP 3/4 TON, K25 / K2500	Todos Suspensión Quad Amortiguador Largo; Exc. Kit de Levantamiento	
F 87	PICKUP 3/4 TON, V2500	Todos Suspensión Quad Amortiguador Largo; Exc. Kit de Levantamiento	
F 81-86	SUBURBAN 1/2 TON, K15 / K1500	Todos Suspensión Quad Amortiguador Largo; Exc. Kit de Levantamiento	
F 87-91	SUBURBAN 1/2 TON, V1500	Todos Suspensión Quad Amortiguador Largo; Exc. Kit de Levantamiento	
F 81-86	SUBURBAN 3/4 TON, K25 / K2500	Todos Suspensión Quad Amortiguador Largo; Exc. Kit de Levantamiento	
F 87-91	SUBURBAN 3/4 TON, V2500	Todos Suspensión Quad Amortiguador Largo; Exc. Kit de Levantamiento	
<b>58908</b>	W		
F 87-91	<b>CHEVROLET BLAZER 4x4</b>	Automóvil Grande; Suspensión Quad Amortiguador Corto; Exc. Kit de Levantamiento	
F 81-86	BLAZER 4x4	Suspensión Quad Amortiguador Corto; Exc. Kit de Levantamiento	
F 81-86	PICKUP 1/2 TON, K10	Todos Suspensión Quad Amortiguador Corto; Exc. Kit de Levantamiento	
F 87	PICKUP 1/2 TON, V10	Todos Suspensión Quad Amortiguador Corto; Exc. Kit de Levantamiento	
F 81-86	PICKUP 3/4 TON, K20	Todos Suspensión Quad Amortiguador Corto; Exc. Kit de Levantamiento	
F 87	PICKUP 3/4 TON, V20	Todos Suspensión Quad Amortiguador Corto; Exc. Kit de Levantamiento	
F 81-86	SUBURBAN 1/2 TON, K10	Todos Suspensión Quad Amortiguador Corto; Exc. Kit de Levantamiento	
F 81-86	SUBURBAN 3/4 TON, K20	Todos Suspensión Quad Amortiguador Corto; Exc. Kit de Levantamiento	
F 87-88	SUBURBAN 3/4 TON, V20	Todos Suspensión Quad Amortiguador Corto; Exc. Kit de Levantamiento	
F 89-91	SUBURBAN 3/4 TON, V2500	Todos Suspensión Quad Amortiguador Corto; Exc. Kit de Levantamiento	
F 73-91	<b>GMC JIMMY 4x4</b>	Suspensión Quad Amortiguador Corto; Exc. Kit de Levantamiento	
F 81-86	PICKUP 1/2 TON, K15 / K1500	Todos Suspensión Quad Amortiguador Corto; Exc. Kit de Levantamiento	
F 87	PICKUP 1/2 TON, V1500	Todos Suspensión Quad Amortiguador Corto; Exc. Kit de Levantamiento	
F 81-86	PICKUP 3/4 TON, K25 / K2500	Todos Suspensión Quad Amortiguador Corto; Exc. Kit de Levantamiento	
F 87	PICKUP 3/4 TON, V2500	Todos Suspensión Quad Amortiguador Corto; Exc. Kit de Levantamiento	
F 81-86	SUBURBAN 1/2 TON, K15 / K1500	Todos Suspensión Quad Amortiguador Corto; Exc. Kit de Levantamiento	
F 87-91	SUBURBAN 1/2 TON, V1500	Todos Suspensión Quad Amortiguador Corto; Exc. Kit de Levantamiento	
F 81-86	SUBURBAN 3/4 TON, K25 / K2500	Todos Suspensión Quad Amortiguador Corto; Exc. Kit de Levantamiento	
F 87-91	SUBURBAN 3/4 TON, V2500	Todos Suspensión Quad Amortiguador Corto; Exc. Kit de Levantamiento	
<b>58929</b>	W		140780
F 90	<b>FORD BRONCO II</b>	Todos	
F 91-94	EXPLORER	Todos	
F 90-97	RANGER	Todos	
F 92-11	VAN 1/2 TON, ECONOLINE / CLUB	WAGON Todos	
F 94-97	<b>MAZDA B2300</b>	Todos	

# Lista numérica

Amort.	POP	No. Alternativo	Montaje Accesorio
Pos.	Año	Aplicación	
<b>58930</b>	W		
R	02-10	<b>CADILLAC</b>	ESCALADE Todos
R	07-11	<b>CHEVROLET</b>	AVALANCHE 1500 Todos Exc. Suspensión Z55 o ZW7
R	02-06	AVALANCHE 1500	Todos Exc. Control de Manejo Electrónico
R	02-06	AVALANCHE 2500	Todos Exc. Control de Manejo Electrónico
R	09-11	SUBURBAN 1/2 TON,	1500 Todos Exc. Suspensión Z55 Auto Ride
R	08	SUBURBAN 1/2 TON,	1500 Todos Exc. Suspensión Z55 o ZW7
R	00-07	SUBURBAN 1/2 TON,	1500 Todos Exc. Suspensión Z55 Auto Ride
R	00-11	SUBURBAN 3/4 TON,	2500 Todos Exc. Suspensión Auto Ride Z55 y Quadrasteer
R	02-11	TAHOE	Todos Exc. Suspensión Z55 o ZW7
R	00-01	TAHOE	Todos Estilo New Body, Exc. Suspensión Z55
R	00-11	<b>GMC</b> YUKON	Todos Exc. Suspensión Z55 o ZW7
R	00-11	YUKON XL 1/2 TON	Todos Exc. Suspensión Z55 Auto Ride
R	00-11	YUKON XL 3/4 TON	Todos Exc. Sistema de Autonivelación NIVOMAT

<b>58942</b>	N		
R	07-12	<b>FORD</b> PICKUP, F-450	SUPERDUTY Cab & Chassis
R	07-12	PICKUP, F-550	SUPERDUTY Todos

### Amortiguadores ProGuard

<b>61500</b>	A		
R	87-93	<b>DODGE</b> PICKUP, RAM 50	4x2 Tracción trasera
R	83-86	PICKUP, RAM 50	Todos
R	55	<b>FORD</b> F SERIES	Todos F-100
F	48-52	F SERIES	Todos F-1, F-2 & F-3
F	65	PICKUP 1/2 TON,	F-100 Todos 4x4 a inicios de 1965
R	61-64	PICKUP 1/2 TON,	F-100 Todos
R	61-66	PICKUP 1 TON,	F-350 / SUPERDUTY Todos
R	61-64	PICKUP 3/4 TON,	F-250 / SUPERDUTY Todos
F	76	PICKUP P350	Todos
F	68-75	PICKUP P350	Todos Hasta PBV 8000#
F	75-76	PICKUP P400	Todos Hasta PBV 8000#
R	68	<b>INTERNATIONAL</b> 908B	Todos
R	68	908C	Todos
R	68	1000B	Todos
R	68	1000C	Todos
F	68	1100B	Todos Exc. Travelette c/ base de rueda de 166"
R	68	1100B	Todos Exc. Travelette c/ base de rueda de 166"
F	68	1100C	Todos Exc. Travelette c/ base de rueda de 166"
R	68	1100C	Todos Exc. Travelette c/ base de rueda de 166"
F	68	1200B	Todos Exc. Travelette c/ base de rueda de 166"
R	68	1200B	Todos Exc. Travelette c/ base de rueda de 166"
F	68	1200C	Todos Exc. Travelette c/ base de rueda de 166"
R	68	1200C	Todos Exc. Travelette c/ base de rueda de 166"
F	68	1300B	Todos Exc. Travelette c/ base de rueda de 166"
R	68	1300B	Todos Exc. Travelette c/ base de rueda de 166"
F	68	1300C	Todos Exc. Travelette c/ base de rueda de 166"
R	68	1300C	Todos Exc. Travelette c/ base de rueda de 166"
R	68-72	M1100 / M1200	Todos
R	69	M1400	Todos
R	65-67	M SERIES	VAN Todos
R	72-83	<b>JEEP</b> CJ5	Todos Exc. Kit de Levantamiento
R	66-71	CJ5	Todos
R	72-75	CJ6	Todos Exc. Kit de Levantamiento
R	66-71	CJ6	Todos
R	68-75	CJ7	
R	76-86	CJ7	Todos Exc. Kit de Levantamiento
R	66-74	DJ5	Todos Exc. Kit de Levantamiento

# Amortiguadores LTV, Amortiguadores ProGuard

Amort.	POP	No. Alternativo	Montaje Accesorio
Pos.	Año	Aplicación	
<b>61500</b>	A		-continued
R	66-68	DJ6	Todos
R	57-60	FC150	Todos
F	63-65	FC170	Todos
R	63-65	FC170	Todos
R	63-66	GLADIATOR	Todos Suspensión Delantera Independiente
R	70-73	JEEPSTER	Todos
R	81-85	SCRAMBLER / CJ8	Todos
R	61-67	UNIVERSAL	Todos
R	86-87	<b>MAZDA</b> B2000	4x2 Tracción trasera
R	87-93	B2200	4x2 Tracción trasera
R	87-93	B2600	4x2 Tracción trasera
R	87-90	<b>MINI</b> SUBSIBISHI	VAN Todos
R	98-04	<b>NISSAN</b> FRONTIER	4x2 Tracción trasera Exc. Desert Runner
R	05-12	PICKUP	
R	95-04	PICKUP	4x2 Tracción trasera
R	65-94	PICKUP	
R	85-95	<b>TOYOTA</b> PICKUP	4x2 Tracción trasera Exc. 1 Ton
R	84	PICKUP	4x2 Tracción trasera
R	75-83	PICKUP	4x2 Tracción trasera Mojave
R	70-74	PICKUP	Todos 4x2 Tracción trasera; Mojave
R	04	TACOMA	Base, 4x2 Tracción trasera
R	95-03	TACOMA	DLX, 4x2 Tracción trasera
R	98-00	TACOMA	SR5, 4x4
R	84-88	VAN Leaf	(RearSpringType)
R	88	VAN WAGON	Todos

<b>61501</b>	A		140857
F	81-95	<b>ISUZU</b> PICKUP	4x2 Tracción trasera
F	05-12	<b>NISSAN</b> PICKUP	
F	98-04	PICKUP	Todos
F	95-97	PICKUP	4x4
F	65-93	PICKUP	

<b>61502</b>	W		140523
R	72-76	<b>MAZDA</b> B1600	Todos
R	77-78	B1800	Todos
R	79-84	B2000	Todos
R	82-84	B2200	Todos

<b>61504</b>	B		140455
F	05	<b>CHEVROLET</b> BLAZER	Base, 4x2 Tracción trasera
F	96-04	BLAZER	LS, 4x2 Tracción trasera
F	95-02	BLAZER	LT, 4x2 Tracción trasera
F	95-99	BLAZER	Base, 4x2 Tracción trasera
F	95-97	BLAZER	Deluxe, 4x2 Tracción trasera
F	83-94	BLAZER, S	MODELS 4x2 Tracción trasera
F	94-03	S10	LS, 4x2 Tracción trasera
F	82-03	S10	Base, 4x2 Tracción trasera
F	92-93	S10	EL, 4x2 Tracción trasera
F	83-92	S10	Tahoe, 4x2 Tracción trasera
F	88-90	S10	Durango, 4x2 Tracción trasera
F	82-86	S10	Durango, 4x2 Tracción trasera
F	92-04	<b>GMC</b> JIMMY	4x2 Tracción trasera
F	83-91	S15	JIMMY 4x2 Tracción trasera
F	04	SONOMA / S15	Todos 4x2 Tracción trasera
F	82-03	SONOMA / S15	4x2 Tracción trasera
F	72-76	<b>MAZDA</b> B1600	Todos
F	77-78	B1800	Todos
F	79-84	B2000	Todos
F	82-84	B2200	Todos
F	75-83	<b>TOYOTA</b> PICKUP	4x2 Tracción trasera Mojave
F	70-74	PICKUP	Todos 4x2 Tracción trasera; Mojave

<b>61506</b>	C		141137
R	87-89	<b>DODGE</b> RAIDER	2.6L 4 Cyl L (156) 2.6L 4 Cyl
F	61-67	<b>FORD</b> ECONOLINE	Todos
F	68	VAN 1/2 TON,	ECONOLINE / CLUB WAGON Todos Fabricado antes de Jul/68
R	81-95	<b>ISUZU</b> PICKUP	Todos
R	86-92	<b>JEEP</b> COMANCHE	Todos
R	00-04	<b>NISSAN</b> FRONTIER	Crew Cab Pickup, 4x2 Tracción trasera con Desert Runner
R	98-04	FRONTIER	4x4
R	98-99	FRONTIER	4x2 Tracción trasera Crew Cab con Desert Runner
R	95-97	PICKUP	4x4
R	65-93	PICKUP	
R	85-92	<b>TOYOTA</b> PICKUP	4x2 Tracción trasera 1 Ton

# Lista numérica

Amort.	POP	No. Alternativo	Montaje Accesorio
Pos.	Año	Aplicación	
<b>61506</b>	C		-continued 141137
R	80-83	PICKUP 4x4	Exc. Kit de Levantamiento
R	93-98	T100 4x2	Tracción trasera
<b>61508</b>	C		140857
F	81-95	<b>ISUZU</b> PICKUP	4x4
F	98-04	<b>NISSAN</b> FRONTIER	4x2 Tracción trasera Exc. Desert Runner
F	95-97	PICKUP	4x2 Tracción trasera
F	65-93	PICKUP	
<b>61509</b>	C		140455
F	93-95	<b>TOYOTA</b> PICKUP	4x2 Tracción trasera Exc. 1 Ton
F	85-92	PICKUP	4x2 Tracción trasera 1 Ton
F	84	PICKUP	4x2 Tracción trasera
F	93-98	T100 4x2	Tracción trasera
<b>61510</b>	A		140149
R	84-89	<b>TOYOTA</b> 4RUNNER	Todos
R	84-95	PICKUP 4x4	Exc. Kit de Levantamiento
R	01-04	TACOMA	S-Runner
R	04	TACOMA	Base, 4x4
R	95-03	TACOMA	DLX, 4x4
R	98-00	TACOMA	Limited
<b>61513</b>	W		140524
R	87-89	<b>TOYOTA</b> VAN	4x2 Tracción trasera, Coil (RearSpringType)
R	84-86	VAN	Coil (RearSpringType)
R	88	VAN WAGON	Todos Resorte Trasero

<b>61516</b>	W		
F	87-91	<b>CHEVROLET</b> BLAZER	4x4 Automóvil Grande; Suspensión Quad Amortiguador Corto; Exc. Kit de Levantamiento
F	81-86	BLAZER	4x4 Suspensión Quad Amortiguador Corto; Exc. Kit de Levantamiento
F	75-80	BLAZER	4x4 Exc. Suspensión Quad y Kit de Levantamiento
F	73-74	BLAZER	4x4 Exc. Kit de Levantamiento
F	69-72	BLAZER	4x4
F	81-86	PICKUP 1/2 TON,	K10 Todos Suspensión Quad Amortiguador Corto; Exc. Kit de Levantamiento
F	74-80	PICKUP 1/2 TON,	K10 Todos Exc. Kit de Levantamiento
F	73	PICKUP 1/2 TON,	K10 Todos Exc. Suspensión Quad y Kit de Levantamiento
F	69-72	PICKUP 1/2 TON,	K10 Todos Exc. Kit de Levantamiento
F	88	PICKUP 1/2 TON,	K15 / K1500 Todos Suspensión Quad Amortiguador Corto; Exc. Kit de Levantamiento
F	87	PICKUP 1/2 TON,	V10 Todos Suspensión Quad Amortiguador Corto; Exc. Kit de Levantamiento
F	81-86	PICKUP 3/4 TON,	K20 Todos Suspensión Quad Amortiguador Corto; Exc. Kit de Levantamiento
F	69-80	PICKUP 3/4 TON,	K20 Todos Exc. Kit de Levantamiento
F	87	PICKUP 3/4 TON,	V20 Todos Exc. Suspensión Quad y Kit de Levantamiento
F	81-86	SUBURBAN 1/2 TON,	K10 Todos Suspensión Quad Amortiguador Corto; Exc. Kit de Levantamiento
F	69-80	SUBURBAN 1/2 TON,	K10 Todos Exc. Kit de Levantamiento
F	87-88	SUBURBAN 1/2 TON,	V10 Todos Suspensión Quad Amortiguador Corto; Exc. Kit de Levantamiento
F	89-91	SUBURBAN 1/2 TON,	V1500 Todos Exc. Suspensión Quad y Kit de Levantamiento
F	81-86	SUBURBAN 3/4 TON,	K20 Todos Suspensión Quad Amortiguador Corto; Exc. Kit de Levantamiento
F	69-80	SUBURBAN 3/4 TON,	K20 Todos Exc. Kit de Levantamiento
F	87-88	SUBURBAN 3/4 TON,	V20 Todos Suspensión Quad Amortiguador Corto; Exc. Kit de Levantamiento
F	89-91	SUBURBAN 3/4 TON,	V2500 Todos Suspensión Quad Amortiguador Corto; Exc. Kit de Levantamiento

Lista numérica

Amort.	POP	No. Alternativo	Montaje Accesorio
Pos.	Año	Aplicación	
<b>61516</b>	W	-continued	
F	70-91	<b>GMC JIMMY</b> 4x4 Exc. Suspensión Quad y Kit de Levantamiento	
F	69-86	<b>PICKUP 1/2 TON, K15 / K1500</b> Todos Exc. Suspensión Quad y Kit de Levantamiento	
F	87	<b>PICKUP 1/2 TON, V1500</b> Todos Suspensión Quad Amortiguador Corto; Exc. Kit de Levantamiento	
F	69-86	<b>PICKUP 3/4 TON, K25 / K2500</b> Todos Exc. Suspensión Quad y Kit de Levantamiento	
F	87	<b>PICKUP 3/4 TON, V2500</b> Todos Suspensión Quad Amortiguador Corto; Exc. Kit de Levantamiento	
F	69-86	<b>SUBURBAN 1/2 TON, K15 / K1500</b> Todos Exc. Suspensión Quad y Kit de Levantamiento	
F	87-91	<b>SUBURBAN 1/2 TON, V1500</b> Todos Suspensión Quad Amortiguador Corto; Exc. Kit de Levantamiento	
F	69-86	<b>SUBURBAN 3/4 TON, K25 / K2500</b> Todos Exc. Suspensión Quad y Kit de Levantamiento	
F	87-91	<b>SUBURBAN 3/4 TON, V2500</b> Todos Suspensión Quad Amortiguador Corto; Exc. Kit de Levantamiento	
<b>61517</b>	D		
F	71-95	<b>CHEVROLET VAN 1/2 TON, G / EXPRESS</b> Todos	
F	70	<b>VAN 1/2 TON, G / EXPRESS</b> Todos Suspensión Delantera Independiente	
F	78-96	<b>VAN 1 TON, G / EXPRESS</b> Todos	
F	75	<b>VAN 1 TON, G / EXPRESS 146.0</b> (WheelBase)	
F	71-74	<b>VAN 1 TON, G / EXPRESS</b> Todos	
F	78-95	<b>VAN 3/4 TON, G / EXPRESS</b> Todos Exc. PBV 8600 #	
F	71-77	<b>VAN 3/4 TON, G / EXPRESS</b> Todos	
F	70	<b>VAN 3/4 TON, G / EXPRESS</b> Todos Suspensión Delantera Independiente	
F	71-95	<b>GMC VAN 1/2 TON, G / SAVANNA</b> Todos	
F	70	<b>VAN 1/2 TON, G / SAVANNA</b> Todos Suspensión Delantera Independiente	
F	76-95	<b>VAN 1 TON, G / SAVANNA</b> Todos	
F	75	<b>VAN 1 TON, G / SAVANNA 110.0</b> (WheelBase)	
F	75	<b>VAN 1 TON, G / SAVANNA 125.0</b> (WheelBase)	
F	71-74	<b>VAN 1 TON, G / SAVANNA</b> Todos	
F	78-95	<b>VAN 3/4 TON, G / SAVANNA</b> Todos Exc. PBV 8600 #	
F	71-77	<b>VAN 3/4 TON, G / SAVANNA</b> Todos	
F	70	<b>VAN 3/4 TON, G / SAVANNA</b> Todos Suspensión Delantera Independiente	
<b>61518</b>	C	140126	
R	79-81	<b>FORD B100</b>	
R	82-85	<b>B150</b>	
R	75-78	<b>B150</b>	
R	66	<b>BRONCO</b> Todos Toda la serie #830000	
R	73-79	<b>PICKUP 1/2 TON, F-100 4x2</b> Tracción trasera	
R	70-72	<b>PICKUP 1/2 TON, F-100</b> Todos 4x2 Tracción trasera	
R	75-79	<b>PICKUP 1/2 TON, F-150 4x2</b> Tracción trasera	
R	75-79	<b>PICKUP 1 TON, F-350 / SUPERDUTY Extended Cab Pickup, 4x2</b> Tracción trasera	
R	74	<b>PICKUP 1 TON, F-350 / SUPERDUTY</b> Todos 4x2 Tracción trasera	
R	75-79	<b>PICKUP 3/4 TON, F-250 / SUPERDUTY Cab &amp; Chassis, 4x2</b> Tracción trasera	
R	75-79	<b>PICKUP 3/4 TON, F-250 / SUPERDUTY Standard Cab Pickup, 4x2</b> Tracción trasera	
R	70-74	<b>PICKUP 3/4 TON, F-250 / SUPERDUTY 4x2</b> Tracción trasera Exc. Supercab	
R	75-91	<b>VAN 1/2 TON, ECONOLINE / CLUB WAGON</b> Todos	
<b>61519</b>	D	141137	
R	73-74	<b>FORD B100</b>	
R	78-79	<b>BRONCO</b> Todos Exc. Kit de Levantamiento	
R	66-77	<b>BRONCO</b> Todos Desde Serie #830001; Exc. Kit de Levantamiento	
R	65-78	<b>F-100</b>	

Amortiguadores ProGuard

Amort.	POP	No. Alternativo	Montaje Accesorio
Pos.	Año	Aplicación	
<b>61519</b>	D	-continued 141137	
R	67-78	<b>F-350 PICKUP</b>	
R	65-69	<b>PICKUP 1/2 TON, F-100</b> Todos 4x2 Tracción trasera	
R	75-79	<b>PICKUP 1 TON, F-350 / SUPERDUTY Standard Cab Pickup, 4x2</b> Tracción trasera	
R	73-74	<b>PICKUP 1 TON, F-350 / SUPERDUTY</b> Todos	
R	75-79	<b>PICKUP 3/4 TON, F-250 / SUPERDUTY Extended Cab Pickup, 4x2</b> Tracción trasera	
R	73-74	<b>PICKUP 3/4 TON, F-250 / SUPERDUTY 4x2</b> Tracción trasera Supercab	
R	70-72	<b>PICKUP 3/4 TON, F-250 / SUPERDUTY</b> Todos 4x2 Tracción trasera; Supercab	
R	65-69	<b>PICKUP 3/4 TON, F-250 / SUPERDUTY</b> Todos 4x2 Tracción trasera	
R	69-74	<b>VAN 1/2 TON, ECONOLINE / CLUB WAGON</b> Todos	
R	68	<b>VAN 1/2 TON, ECONOLINE / CLUB WAGON</b> Todos A finales de 1968	
R	69-74	<b>VAN 1 TON, ECONOLINE / CLUB WAGON / SUPERDUTY</b> Todos	
R	68	<b>VAN 1 TON, ECONOLINE / CLUB WAGON / SUPERDUTY</b> Todos A finales de 1968	
R	69-74	<b>VAN 3/4 TON, ECONOLINE / CLUB WAGON / SUPERDUTY</b> Todos	
R	68	<b>VAN 3/4 TON, ECONOLINE / CLUB WAGON / SUPERDUTY</b> Todos A finales de 1968	
R	76-83	<b>JEEP CHEROKEE</b> Todos	
F	74-83	<b>CHEROKEE</b> Todos	
F	82-83	<b>CJ5</b> Todos Exc. Kit de Levantamiento	
F	82-86	<b>CJ7</b> Todos Exc. Kit de Levantamiento	
R	67	<b>GLADIATOR</b> Todos	
F	84-91	<b>GRAND WAGONEER</b> Todos	
R	84-91	<b>GRAND WAGONEER</b> Todos	
F	74-88	<b>J10 PICKUP</b> Todos	
R	74-88	<b>J10 PICKUP</b> Todos	
F	74-88	<b>J20 PICKUP</b> Todos	
R	74-88	<b>J20 PICKUP</b> Todos	
F	68-73	<b>J2500 PICKUP</b> Todos	
R	82-85	<b>SCRAMBLER / CJ8</b> Todos	
R	76-83	<b>WAGONEER</b> Todos	
R	74-83	<b>WAGONEER</b> Todos	
<b>61520</b>	A	140780	
F	82-85	<b>FORD B150</b>	
F	92	<b>B200</b>	
F	97	<b>BRONCO</b>	
F	80-96	<b>BRONCO</b> Todos Con o sin Suspensión Quad detrás del Eje Delantero; Exc. Kit de Levantamiento	
F	89	<b>BRONCO II</b> Todos Fab. hasta 2/89; Vehículos con perno 10mm & 12mm en montaje inferior trasero	
F	84-88	<b>BRONCO II</b> Todos Con Perno de 10mm en Montaje Inferior Trasero	
F	86-90	<b>F-200</b>	
F	99-00	<b>F-350 PICKUP</b>	
F	80-83	<b>PICKUP 1/2 TON, F-100 4x2</b> Tracción trasera	
F	80-96	<b>PICKUP 1/2 TON, F-150 4x4</b> Con o sin Suspensión Quad detrás del Eje Delantero; Exc. Kit de Levantamiento	
F	80-96	<b>PICKUP 1/2 TON, F-150 4x2</b> Tracción trasera	
F	80-97	<b>PICKUP 1 TON, F-350 / SUPERDUTY 4x2</b> Tracción trasera	
F	97	<b>PICKUP 3/4 TON, F-250 / SUPERDUTY 4x2</b> Tracción trasera PBV arriba de 8500#	
F	80-96	<b>PICKUP 3/4 TON, F-250 / SUPERDUTY 4x2</b> Tracción trasera	
F	87-89	<b>RANGER</b> Todos Exc. Opción High Ryder	
F	83-86	<b>RANGER</b> Todos	
<b>61521</b>	B	140780	
F	85-91	<b>FORD B200</b>	
F	78-79	<b>BRONCO</b> Todos Suspensión Quad; detrás del Eje Delantero; Exc. Kit de Levantamiento	
F	66-77	<b>BRONCO</b> Todos Desde Serie #830001; Exc. Kit de Levantamiento	

Lista numérica

Amort.	POP	No. Alternativo	Montaje Accesorio
Pos.	Año	Aplicación	
<b>61521</b>	B	-continued 140780	
F	73-79	<b>PICKUP 1/2 TON, F-100 4x2</b> Tracción trasera	
F	65-72	<b>PICKUP 1/2 TON, F-100</b> Todos 4x2 Tracción trasera	
F	75-79	<b>PICKUP 1/2 TON, F-150 4x2</b> Tracción trasera	
F	75-79	<b>PICKUP 1 TON, F-350 / SUPERDUTY 4x2</b> Tracción trasera	
F	67-74	<b>PICKUP 1 TON, F-350 / SUPERDUTY</b> Todos 4x2 Tracción trasera	
F	73-79	<b>PICKUP 3/4 TON, F-250 / SUPERDUTY 4x2</b> Tracción trasera	
F	65-72	<b>PICKUP 3/4 TON, F-250 / SUPERDUTY</b> Todos 4x2 Tracción trasera	
F	75-91	<b>VAN 1 TON, ECONOLINE / CLUB WAGON / SUPERDUTY</b> Todos Exc. Conversión Motorhome	
F	75-91	<b>VAN 3/4 TON, ECONOLINE / CLUB WAGON / SUPERDUTY</b> Todos	
<b>61522</b>	C		
F	87-91	<b>CHEVROLET BLAZER 4x4</b> Automóvil Grande; Suspensión Quad Amortiguador Largo; Exc. Kit de Levantamiento	
F	81-86	<b>BLAZER 4x4</b> Suspensión Quad Amortiguador Largo; Exc. Kit de Levantamiento	
F	81-86	<b>PICKUP 1/2 TON, K10</b> Todos Suspensión Quad Amortiguador Largo; Exc. Kit de Levantamiento	
F	88	<b>PICKUP 1/2 TON, K15 / K1500</b> Todos Suspensión Quad Amortiguador Largo; Exc. Kit de Levantamiento	
F	87	<b>PICKUP 1/2 TON, V10</b> Todos Suspensión Quad Amortiguador Largo; Exc. Kit de Levantamiento	
F	81-86	<b>PICKUP 3/4 TON, K20</b> Todos Suspensión Quad Amortiguador Largo; Exc. Kit de Levantamiento	
F	87	<b>PICKUP 3/4 TON, V20</b> Todos Suspensión Quad Amortiguador Largo; Exc. Kit de Levantamiento	
F	81-86	<b>SUBURBAN 1/2 TON, K10</b> Todos Suspensión Quad Amortiguador Largo; Exc. Kit de Levantamiento	
F	87-88	<b>SUBURBAN 1/2 TON, V10</b> Todos Suspensión Quad Amortiguador Largo; Exc. Kit de Levantamiento	
F	81-86	<b>SUBURBAN 3/4 TON, K20</b> Todos Suspensión Quad Amortiguador Largo; Exc. Kit de Levantamiento	
F	87-88	<b>SUBURBAN 3/4 TON, V20</b> Todos Suspensión Quad Amortiguador Largo; Exc. Kit de Levantamiento	
F	89-91	<b>SUBURBAN 3/4 TON, V2500</b> Todos Suspensión Quad Amortiguador Largo; Exc. Kit de Levantamiento	
R	78-95	<b>VAN 1/2 TON, G / EXPRESS</b> Todos	
R	78-95	<b>VAN 1 TON, G / EXPRESS</b> Cutaway Van	
R	78-95	<b>VAN 3/4 TON, G / EXPRESS</b> Todos Exc. PBV 8600 #	
R	99-03	<b>DODGE VAN 1/2 TON, A / B SERIES / RAM 109.3</b> (WheelBase) Exc. PBV 7000#	
R	81-98	<b>VAN 1/2 TON, A / B SERIES / RAM 109.6</b> (WheelBase) Exc. PBV 7000#	
R	71-80	<b>VAN 1/2 TON, A / B SERIES / RAM</b> Todos	
R	99-03	<b>VAN 1 TON, A / B SERIES / RAM</b> Todos	
R	95-98	<b>VAN 1 TON, A / B SERIES / RAM</b> Todos Exc. Eje Delantero 4000#	
R	71-94	<b>VAN 1 TON, A / B SERIES / RAM</b> Todos	
R	71-03	<b>VAN 3/4 TON, A / B SERIES / RAM</b> Todos	
R	74-80	<b>VAN, CB300</b> Todos	
F	73-91	<b>GMC JIMMY 4x4</b> Suspensión Quad Amortiguador Largo; Exc. Kit de Levantamiento	
F	81-86	<b>PICKUP 1/2 TON, K15 / K1500</b> Todos Suspensión Quad Amortiguador Largo; Exc. Kit de Levantamiento	
F	87	<b>PICKUP 1/2 TON, V1500</b> Todos Suspensión Quad Amortiguador Largo; Exc. Kit de Levantamiento	

### Lista numérica

Amort.	POP	No. Alternativo	Montaje Accesorio
Pos.	Año	Aplicación	
<b>61522</b>	C	-continued	
F	81-86	PICKUP 3/4 TON, K25 / K2500 Todos Suspensión Quad Amortiguador Largo; Exc. Kit de Levantamiento	
F	87	PICKUP 3/4 TON, V2500 Todos Suspensión Quad Amortiguador Largo; Exc. Kit de Levantamiento	
F	81-86	SUBURBAN 1/2 TON, K15 / K1500 Todos Suspensión Quad Amortiguador Largo; Exc. Kit de Levantamiento	
F	87-91	SUBURBAN 1/2 TON, V1500 Todos Suspensión Quad Amortiguador Largo; Exc. Kit de Levantamiento	
F	81-86	SUBURBAN 3/4 TON, K25 / K2500 Todos Suspensión Quad Amortiguador Largo; Exc. Kit de Levantamiento	
F	87-91	SUBURBAN 3/4 TON, V2500 Todos Suspensión Quad Amortiguador Largo; Exc. Kit de Levantamiento	
R	78-95	VAN 1/2 TON, G / SAVANNA Todos	
R	85-96	VAN 1 TON, G / SAVANNA Extended Cargo Van	
R	85-96	VAN 1 TON, G / SAVANNA Extended Passenger Van	
R	79-96	VAN 1 TON, G / SAVANNA Standard Cargo Van	
R	79-96	VAN 1 TON, G / SAVANNA Standard Passenger Van	
R	78	VAN 1 TON, G / SAVANNA Cutaway Van	
R	78-95	VAN 3/4 TON, G / SAVANNA Todos Exc. PBV 8600 #	
R	74-83	PLYMOUTH VAN 1/2 TON, PB SERIES Todos	
R	74-83	VAN 1 TON, PB SERIES Todos	
R	74-83	VAN 3/4 TON, PB SERIES Todos	
<b>61523</b>	C	140126	
F	70-93	DODGE PICKUP 1/2 TON, D100 SERIES Todos	
F	72-93	PICKUP 3/4 TON, D200 SERIES Todos Exc. Paquete HD	
F	95-96	RAMCHARGER 4x2 Tracción trasera	
F	75-93	RAMCHARGER 4x2 Tracción trasera	
F	99-03	VAN 1/2 TON, A / B SERIES / RAM 109.3 (WheelBase) Exc. PBV 7000#	
F	81-98	VAN 1/2 TON, A / B SERIES / RAM 109.6 (WheelBase) Exc. PBV 7000#	
F	71-80	VAN 1/2 TON, A / B SERIES / RAM Todos	
F	99-03	VAN 1 TON, A / B SERIES / RAM Todos	
F	71-98	VAN 1 TON, A / B SERIES / RAM Todos Exc. Eje Delantero 4000#	
F	71-03	VAN 3/4 TON, A / B SERIES / RAM Todos	
F	74-80	VAN, CB300 Todos Exc. Eje Delantero 4000#	
F	75-81	PLYMOUTH TRAILDUSTER 4x2 Tracción trasera	
F	74-83	VAN 1/2 TON, PB SERIES Todos	
F	74-83	VAN 1 TON, PB SERIES Todos Exc. Eje Delantero 4000#	
F	74-83	VAN 3/4 TON, PB SERIES Todos	
<b>61524</b>	C	140357	
R	87-91	CHEVROLET BLAZER Todos Automóvil Grande; Exc. Suspensión Quad y Kit de Levantamiento	
R	73-86	BLAZER Todos Exc. Kit de Levantamiento	
R	73-86	PICKUP 1/2 TON, C10 Todos	
R	73-86	PICKUP 1/2 TON, K10 Todos Exc. Suspensión Quad y Kit de Levantamiento	
R	87	PICKUP 1/2 TON, R10 Todos	
R	87	PICKUP 1/2 TON, V10 Todos Exc. Suspensión Quad y Kit de Levantamiento	
R	73-74	PICKUP 3/4 TON, C20 Todos Standard Cab Pickup	
R	73-86	PICKUP 3/4 TON, K20 Todos Exc. Suspensión Quad y Kit de Levantamiento	
R	87	PICKUP 3/4 TON, R20 Standard Cab Pickup	
R	87	PICKUP 3/4 TON, V20 Todos Exc. Suspensión Quad y Kit de Levantamiento	
R	73-86	SUBURBAN 1/2 TON, C10 Todos	

### Amortiguadores ProGuard

Amort.	POP	No. Alternativo	Montaje Accesorio
Pos.	Año	Aplicación	
<b>61524</b>	C	-continued 140357	
R	73-86	SUBURBAN 1/2 TON, K10 Todos Exc. Suspensión Quad y Kit de Levantamiento	
R	87-88	SUBURBAN 1/2 TON, R10 Todos	
R	89-91	SUBURBAN 1/2 TON, R1500 Todos	
R	89-91	SUBURBAN 1/2 TON, V1500 Todos Exc. Suspensión Quad y Kit de Levantamiento	
R	73-86	SUBURBAN 3/4 TON, C20 Todos	
R	73-86	SUBURBAN 3/4 TON, K20 Todos Exc. Suspensión Quad y Kit de Levantamiento	
R	87-88	SUBURBAN 3/4 TON, R20 Todos	
R	89-91	SUBURBAN 3/4 TON, R2500 Todos	
R	87-88	SUBURBAN 3/4 TON, V20 Todos Exc. Suspensión Quad y Kit de Levantamiento	
R	89-91	SUBURBAN 3/4 TON, V2500 Todos Exc. Suspensión Quad y Kit de Levantamiento	
R	73	VAN 1/2 TON, P SERIES Todos	
R	73-78	VAN 3/4 TON, P SERIES Todos	
R	73-91	GMC JIMMY Todos Exc. Kit de Levantamiento	
R	73-86	PICKUP 1/2 TON, C15 / C1500 Todos	
R	73-86	PICKUP 1/2 TON, K15 / K1500 Todos Exc. Kit de Levantamiento	
R	87	PICKUP 1/2 TON, R1500 Todos	
R	87	PICKUP 1/2 TON, V1500 Todos Exc. Kit de Levantamiento	
R	75-86	PICKUP 3/4 TON, C25 / C2500 Cab & Chassis	
R	75-86	PICKUP 3/4 TON, C25 / C2500 Standard Cab Pickup	
R	73-74	PICKUP 3/4 TON, C25 / C2500 Todos Exc. Crew Cab & Bonus Cab	
R	73-86	PICKUP 3/4 TON, K25 / K2500 Todos Exc. Kit de Levantamiento	
R	88-89	PICKUP 3/4 TON, R2500 Todos Exc. Crew Cab & Bonus Cab	
R	87	PICKUP 3/4 TON, R2500 Cab & Chassis Exc. Crew Cab & Bonus Cab	
R	87	PICKUP 3/4 TON, R2500 Standard Cab Pickup Exc. Crew Cab & Bonus Cab	
R	87	PICKUP 3/4 TON, V2500 Todos Exc. Kit de Levantamiento	
R	73-86	SUBURBAN 1/2 TON, C15 / C1500 Todos	
R	73-86	SUBURBAN 1/2 TON, K15 / K1500 Todos Exc. Kit de Levantamiento	
R	87-91	SUBURBAN 1/2 TON, R1500 Todos	
R	87-91	SUBURBAN 1/2 TON, V1500 Todos Exc. Kit de Levantamiento	
R	75-86	SUBURBAN 3/4 TON, C25 / C2500 Todos	
R	73-74	SUBURBAN 3/4 TON, C25 / C2500 Todos Exc. Crew Cab & Bonus Cab	
R	73-86	SUBURBAN 3/4 TON, K25 / K2500 Todos Exc. Kit de Levantamiento	
R	87-91	SUBURBAN 3/4 TON, R2500 Todos	
R	87-91	SUBURBAN 3/4 TON, V2500 Todos Exc. Kit de Levantamiento	
R	73	VAN 1/2 TON, P SERIES Todos	
R	73-78	VAN 3/4 TON, P SERIES Todos	
<b>61525</b>	B	140702	
F	69-84	CHEVROLET BLAZER 4x2 Tracción trasera	
F	63-86	PICKUP 1/2 TON, C10 Todos	
F	87	PICKUP 1/2 TON, R10 Todos	
F	63-86	PICKUP 1 TON, C30 Todos	
F	88-91	PICKUP 1 TON, C35/3500 Cab & Chassis	
F	87-88	PICKUP 1 TON, R30 Todos	
F	89	PICKUP 1 TON, R3500 Standard Cab Pickup	
F	63-74	PICKUP 3/4 TON, C20 Todos	
F	88	PICKUP 3/4 TON, R20 Todos	
F	87	PICKUP 3/4 TON, R20 Crew Cab Pickup	
F	89	PICKUP 3/4 TON, R2500 Todos	
F	63-67	SUBURBAN 1/2 TON, 1500 Todos	
F	63-86	SUBURBAN 1/2 TON, C10 Todos	
F	87-88	SUBURBAN 1/2 TON, R10 Todos	
F	89-91	SUBURBAN 1/2 TON, R1500 Todos	
F	67-86	SUBURBAN 3/4 TON, C20 Todos	
F	87-88	SUBURBAN 3/4 TON, R20 Todos	
F	89-91	SUBURBAN 3/4 TON, R2500 Todos	
F	63-80	VAN 1/2 TON, P SERIES Todos	
F	68-89	VAN 3/4 TON, P SERIES Todos	
F	75-84	GMC JIMMY 4x2 Tracción trasera	

### Lista numérica

Amort.	POP	No. Alternativo	Montaje Accesorio
Pos.	Año	Aplicación	
<b>61525</b>	B	-continued 140702	
F	70-74	JIMMY Todos 4x2 Tracción trasera	
F	67-86	PICKUP 1/2 TON, C15 / C1500 Todos	
F	87	PICKUP 1/2 TON, R1500 Todos	
F	88-91	PICKUP 1 TON, C35/3500 Cab & Chassis Eje Delantero Rígido HD	
F	80-85	PICKUP 1 TON, C35/3500 Todos	
F	67-78	PICKUP 1 TON, C35/3500 Todos	
F	87-91	PICKUP 1 TON, R3500 Todos	
F	85-86	PICKUP 3/4 TON, C25 / C2500 Crew Cab Pickup	
F	75-86	PICKUP 3/4 TON, C25 / C2500 Cab & Chassis	
F	75-86	PICKUP 3/4 TON, C25 / C2500 Standard Cab Pickup	
F	75-83	PICKUP 3/4 TON, C25 / C2500 Crew Cab Pickup	
F	67-74	PICKUP 3/4 TON, C25 / C2500 Todos	
F	87-89	PICKUP 3/4 TON, R2500 Todos Exc. Crew Cab & Bonus Cab	
F	63-65	PICKUP 1500 SERIES Todos	
F	75-86	SUBURBAN 1/2 TON, C15 / C1500 Todos	
F	68-74	SUBURBAN 1/2 TON, C15 / C1500 Todos Resortes Helicoidales Delanteros	
F	87-91	SUBURBAN 1/2 TON, R1500 Todos	
F	68-86	SUBURBAN 3/4 TON, C25 / C2500 Todos	
F	87-91	SUBURBAN 3/4 TON, R2500 Todos	
F	67-80	VAN 1/2 TON, P SERIES Todos	
F	91	VAN 1 TON, P SERIES Todos	
F	75-90	VAN 1 TON, P SERIES Todos Exc. Chasis Motorhome	
F	73-74	VAN 1 TON, P SERIES Base Exc. Chasis Motorhome	
F	68-72	VAN 1 TON, P SERIES Todos	
F	68-89	VAN 3/4 TON, P SERIES Todos	
F	63-65	VAN, PB 1000 SERIES Todos	
<b>61526</b>	C		
R	72-93	DODGE PICKUP 1/2 TON, D100 SERIES Todos	
R	72-93	PICKUP 1 TON, D300 SERIES Todos	
R	72-93	PICKUP 3/4 TON, D200 SERIES Todos	
R	95-96	RAMCHARGER 4x2 Tracción trasera	
R	74-93	RAMCHARGER 4x2 Tracción trasera	
R	74-81	PLYMOUTH TRAILDUSTER 4x2 Tracción trasera	
<b>61528</b>	B		
R	05	CHEVROLET BLAZER Base, 4x4	
R	05	BLAZER Base, 4x2 Tracción trasera	
R	96-04	BLAZER LS, 4x4	
R	96-04	BLAZER LS, 4x2 Tracción trasera	
R	95-02	BLAZER LT, 4x2 Tracción trasera	
R	95-01	BLAZER LT, 4x4	
R	95-99	BLAZER Base, 4x4	
R	95-99	BLAZER Base, 4x2 Tracción trasera	
R	95-97	BLAZER Deluxe, 4x2 Tracción trasera	
R	83-94	BLAZER, S MODELS Todos	
R	99-04	S10 LS, 4x4	
R	99-03	S10 Base, 4x4	
R	99-03	S10 Base, 4x2 Tracción trasera	
R	99-03	S10 LS, 4x2 Tracción trasera	
R	94-98	S10 LS	
R	82-98	S10 Base	
R	92-93	S10 EL	
R	83-92	S10 Tahoe	
R	88-90	S10 Durango	
R	82-86	S10 Durango	
R	05	GMC JIMMY 4x4	
R	92-04	JIMMY Todos	
R	83-91	S15 JIMMY Todos	
R	82-04	SONOMA / S15 Todos	
R	91	SYCLONE Todos	
R	92-93	TYPHOON Todos	
<b>61529</b>	D	140673	
F	87-93	DODGE PICKUP, RAM 50 4x4	
F	87-89	RAIDER Todos	
F	87-89	TOYOTA VAN 4x2 Tracción trasera	
F	84-86	VAN Todos	
F	88	VAN WAGON 4x2 Tracción trasera	
<b>61530</b>	C		
R	86-90	FORD F-200	
R	80-96	PICKUP 1/2 TON, F-150 4x4 Exc. Kit de Levantamiento	

Lista numérica

Amort.	POP	No. Alternativo	Montaje Accesorio
Pos.	Año	Aplicación	
<b>61530</b>	C	-continued	
R	86-97	PICKUP 1 TON, F-350 / SUPERDUTY 4x4 Doble Rodada Trasera	
R	82-85	PICKUP 1 TON, F-350 / SUPERDUTY 4x4 Montaje Inferior Delantero Tipo Abrazadera Exc. Doble Rodado o Kit de Levantamiento	
R	80-81	PICKUP 1 TON, F-350 / SUPERDUTY 4x4 Doble Rodada Trasera	
R	97	PICKUP 3/4 TON, F-250 / SUPERDUTY 4x4 PBV arriba de 8500#	
R	86-96	PICKUP 3/4 TON, F-250 / SUPERDUTY 4x4	
R	82-85	PICKUP 3/4 TON, F-250 / SUPERDUTY 4x4 Montaje Inferior Delantero Tipo Abrazadera Exc. Doble Rodado o Kit de Levantamiento	
R	80-81	PICKUP 3/4 TON, F-250 / SUPERDUTY 4x4	
<b>61531</b>	C		
F	05	CHEVROLET BLAZER Base, 4x4	
F	96-04	BLAZER LS, 4x4	
F	95-01	BLAZER LT, 4x4	
F	95-99	BLAZER Base, 4x4	
F	83-94	BLAZER, S MODELS 4x4	
F	94-04	S10 LS, 4x4	
F	83-03	S10 Base, 4x4	
F	92-93	S10 EL, 4x4	
F	83-92	S10 Tahoe, 4x4	
F	88-90	S10 Durango, 4x4	
F	83-86	S10 Durango, 4x4	
F	92-05	GMC JIMMY 4x4	
F	83-91	S15 JIMMY 4x4	
F	83-04	SONOMA / S15 4x4	
F	91	SYCLONE Todos	
F	92-93	TYPHOON Todos	
<b>61532</b>	W		
R	87-93	DODGE PICKUP, RAM 50 4x4	
<b>61533</b>	C		
R	89	FORD BRONCO II Todos Fab. hasta 2/89; Vehículos con perno 10mm & 12mm en montaje inferior trasero	
R	84-88	BRONCO II Todos Con Perno de 10mm en Montaje Inferior Trasero	
R	89	RANGER 4x2 Tracción trasera Fab. hasta 2/89; Vehículos con perno 10mm & 12mm en montaje inferior trasero	
R	83-88	RANGER 4x2 Tracción trasera	
<b>61534</b>	D		
R	83-89	FORD RANGER 4x4	
<b>61535</b>	B	141353	
F	84-01	JEEP CHEROKEE Todos	
F	86-92	COMANCHE Todos	
F	93-98	GRAND CHEROKEE Todos	
F	84-90	WAGONEER Todos	
<b>61536</b>	D		
R	84-01	JEEP CHEROKEE Todos	
R	84-90	WAGONEER Todos	
<b>61539</b>	C		
R	90-05	CHEVROLET ASTRO Todos	
R	85-89	ASTRO 4x2 Tracción trasera	
R	90-05	GMC SAFARI Todos	
R	85-89	SAFARI 4x2 Tracción trasera	
R	86-89	VOLKSWAGEN VANAGON 4x4	
<b>61540</b>	C	140126	
F	86-97	FORD AEROSTAR 4x2 Tracción trasera	
<b>61541</b>	D		
R	86-88	FORD AEROSTAR 4x2 Tracción trasera	
R	87-95	JEEP WRANGLER YJ (Código plataforma del fabricante)	
<b>61542</b>	C		
F	99-00	CADILLAC ESCALADE Todos	
F	90-05	CHEVROLET ASTRO AWD	
F	92-94	BLAZER 4x4 Automóvil Grande	
F	88-00	PICKUP 1 TON, K35 / K3500 Todos	
F	88-00	PICKUP 3/4 TON, K25 / K2500 Todos	

Amortiguadores ProGuard

Amort.	POP	No. Alternativo	Montaje Accesorio
Pos.	Año	Aplicación	
<b>61542</b>	C	-continued	
F	92-99	SUBURBAN 1/2 TON, K15 / K1500 Todos	
F	92-99	SUBURBAN 3/4 TON, K25 / K2500 Todos	
F	95-00	TAHOE 4x4 Old Body Style	
F	88-00	GMC PICKUP 1 TON, K35 / K3500 Todos	
F	88-00	PICKUP 3/4 TON, K25 / K2500 Todos	
F	90-05	SAFARI AWD	
F	92-99	SUBURBAN 1/2 TON, K15 / K1500 Todos	
F	92-99	SUBURBAN 3/4 TON, K25 / K2500 Todos	
F	92-99	YUKON 4x4	
F	99	YUKON Denali	
<b>61543</b>	B		
R	88-99	CHEVROLET PICKUP 1/2 TON, C15 / C1500 Todos	
R	88-99	PICKUP 1/2 TON, K15 / K1500 Todos	
R	01-03	PICKUP 1 TON, C35/3500 HD Eje Delantero Rígido	
R	91-00	PICKUP 1 TON, C35/3500 Todos Eje Delantero Rígido HD	
R	88-90	PICKUP 1 TON, C35/3500 Extended Cab Pickup Eje Delantero Rígido HD	
R	88-90	PICKUP 1 TON, C35/3500 Standard Cab Pickup Eje Delantero Rígido HD	
R	88-00	PICKUP 1 TON, K35 / K3500 Todos	
R	88-00	PICKUP 3/4 TON, C25 / C2500 Todos	
R	88-00	PICKUP 3/4 TON, K25 / K2500 Todos	
R	88-99	GMC PICKUP 1/2 TON, C15 / C1500 Todos	
R	88-99	PICKUP 1/2 TON, K15 / K1500 Todos	
R	91-00	PICKUP 1 TON, C35/3500 Todos Eje Delantero Rígido HD	
R	88-90	PICKUP 1 TON, C35/3500 Extended Cab Pickup Eje Delantero Rígido HD	
R	88-90	PICKUP 1 TON, C35/3500 Standard Cab Pickup Eje Delantero Rígido HD	
R	88-00	PICKUP 1 TON, K35 / K3500 Todos	
R	88-00	PICKUP 3/4 TON, C25 / C2500 Todos	
R	88-00	PICKUP 3/4 TON, K25 / K2500 Todos	
<b>61544</b>	A	141277	
F	88-99	CHEVROLET PICKUP 1/2 TON, C15 / C1500 Todos	
F	92-00	PICKUP 1 TON, C35/3500 Crew Cab Pickup Eje Delantero Rígido HD	
F	88-00	PICKUP 1 TON, C35/3500 Extended Cab Pickup Eje Delantero Rígido HD	
F	88-00	PICKUP 1 TON, C35/3500 Standard Cab Pickup Eje Delantero Rígido HD	
F	88-00	PICKUP 3/4 TON, C25 / C2500 Todos	
F	92-99	SUBURBAN 1/2 TON, C15 / C1500 Todos	
F	92-99	SUBURBAN 3/4 TON, C25 / C2500 Todos	
F	95-00	TAHOE 4x2 Tracción trasera Old Body Style	
F	88-99	GMC PICKUP 1/2 TON, C15 / C1500 Todos	
F	92-00	PICKUP 1 TON, C35/3500 Crew Cab Pickup Eje Delantero Rígido HD	
F	88-00	PICKUP 1 TON, C35/3500 Extended Cab Pickup Eje Delantero Rígido HD	
F	88-00	PICKUP 1 TON, C35/3500 Standard Cab Pickup Eje Delantero Rígido HD	
F	88-00	PICKUP 3/4 TON, C25 / C2500 Todos	
F	92-99	SUBURBAN 1/2 TON, C15 / C1500 Todos	
F	92-99	SUBURBAN 3/4 TON, C25 / C2500 Todos	
F	92-99	YUKON 4x2 Tracción trasera	
<b>61545</b>	W	141349	
F	87-89	TOYOTA VAN 4x4	
<b>61546</b>	C	141047	
F	80-96	FORD BRONCO Todos Suspensión Quad adelante del Eje Delantero; Exc. Kit de Levantamiento	
F	83-85	F-350 PICKUP	
F	80	F-350 PICKUP	

Lista numérica

Amort.	POP	No. Alternativo	Montaje Accesorio
Pos.	Año	Aplicación	
<b>61546</b>	C	-continued	
F	80-96	PICKUP 1/2 TON, F-150 4x4 Suspensión Quad adelante del Eje Delantero; Exc. Kit de Levantamiento	
F	80-81	PICKUP 1 TON, F-350 / SUPERDUTY 4x4	
F	80-82	PICKUP 3/4 TON, F-250 / SUPERDUTY 4x4	
<b>61547</b>	C		
R	92	FORD B200	
R	85-96	PICKUP 1/2 TON, F-150 4x2 Tracción trasera	
R	80-97	PICKUP 1 TON, F-350 / SUPERDUTY 4x2 Tracción trasera Exc. Doble Rodada Trasera	
R	97	PICKUP 3/4 TON, F-250 / SUPERDUTY 4x2 Tracción trasera PBV arriba de 8500#	
R	80-96	PICKUP 3/4 TON, F-250 / SUPERDUTY 4x2 Tracción trasera	
<b>61551</b>	D	141353	
F	78-79	FORD BRONCO Todos Suspensión Quad adelante del Eje Delantero; Exc. Kit de Levantamiento	
F	78-79	PICKUP 1/2 TON, F-150 Ranger Lariat, 4x4 Suspensión Quad Amortiguador Largo; Exc. Kit de Levantamiento	
F	78-79	PICKUP 1/2 TON, F-150 Ranger, 4x4 Suspensión Quad Amortiguador Largo; Exc. Kit de Levantamiento	
F	79	PICKUP 1/2 TON, F-150 Custom, 4x4 Suspensión Quad adelante del Eje Delantero; Exc. Kit de Levantamiento	
F	78	PICKUP 1/2 TON, F-150 Base, 4x4 Suspensión Quad Amortiguador Largo; Exc. Kit de Levantamiento	
F	78	PICKUP 1/2 TON, F-150 Custom, 4x4 Suspensión Quad Amortiguador Largo; Exc. Kit de Levantamiento	
F	78	PICKUP 1/2 TON, F-150 Northland, 4x4 Suspensión Quad Amortiguador Largo; Exc. Kit de Levantamiento	
F	87-95	JEEP WRANGLER YJ (Código plataforma del fabricante)	
<b>61552</b>	C	140524	
F	86-95	TOYOTA 4RUNNER Todos	
F	86-95	PICKUP 4x4 Exc. Kit de Levantamiento	
F	93-98	T100 4x4	
<b>61553</b>	D	140780	
F	79-81	FORD B100	
F	73-74	B100	
F	82	B150	
F	75-78	B150	
F	75-91	VAN 1/2 TON, ECONOLINE / CLUB WAGON Todos	
<b>61554</b>	C		
R	97	FORD BRONCO	
R	80-96	BRONCO Todos Exc. Kit de Levantamiento	
R	80-83	PICKUP 1/2 TON, F-100 4x2 Tracción trasera	
R	80-84	PICKUP 1/2 TON, F-150 4x2 Tracción trasera	
R	90-97	PICKUP 1/2 TON, F SUPERDUTY Todos	
R	80-97	PICKUP 1 TON, F-350 / SUPERDUTY 4x2 Tracción trasera Doble Rodada Trasera	
R	97	PICKUP, F-450 SUPERDUTY Todos	
<b>61555</b>	B	142615	
F	85-05	CHEVROLET ASTRO 4x2 Tracción trasera	
F	83-85	IMPALA Todos Modelos Policía y Taxi	
F	71-82	IMPALA Sedan Modelos Policía y Taxi	
F	96-02	VAN 1/2 TON, G / EXPRESS Todos	
F	97-02	VAN 1 TON, G / EXPRESS Todos	
F	96-02	VAN 3/4 TON, G / EXPRESS Todos Exc. PBV 8600 #	
F	93-02	FORD CROWN VICTORIA Police Interceptor Modelos Policía y Taxi	
F	85-05	GMC SAFARI 4x2 Tracción trasera	
F	96-02	VAN 1/2 TON, G / SAVANNA Todos	
F	96-02	VAN 1 TON, G / SAVANNA Todos	

## Lista numérica

Amort.	POP	No. Alternativo	Montaje Accesorio
Pos.	Año	Aplicación	
61555	B	-continued	142615
F	96-02	VAN 3/4 TON, G / SAVANNA Todos Exc. PBV 8600 #	
61556	D		140455
F	87-93	<b>DODGE</b> PICKUP, RAM 50 4x2 Tracción trasera	
F	83-86	PICKUP, RAM 50 Todos	
61557	D		
R	90-97	<b>FORD</b> AEROSTAR Todos	
R	89	AEROSTAR 4x2 Tracción trasera	
61559	A		
R	90	<b>FORD</b> BRONCO II Todos	
R	89	BRONCO II Todos Fab. desde 2/89; Vehículos con perno de 12mm en montaje inferior trasero	
R	90-97	RANGER 4x2 Tracción trasera	
R	89	RANGER 4x2 Tracción trasera Fab. desde 2/89; Vehículos con perno de 12mm en montaje inferior trasero	
R	94-97	<b>MAZDA</b> B2300 4x2 Tracción trasera	
R	94-97	B3000 4x2 Tracción trasera	
R	94	B4000 4x2 Tracción trasera	
61561	A		140780
F	90	<b>FORD</b> BRONCO II Todos	
F	90-97	RANGER Todos	
F	94-97	<b>MAZDA</b> B2300 Todos	
F	94-97	B3000 Todos	
F	94-97	B4000 4x2 Tracción trasera	
61565	C		
R	99-00	<b>CADILLAC</b> ESCALADE Todos	
R	92-94	<b>CHEVROLET</b> BLAZER 4x4 Automóvil Grande	
R	92-99	SUBURBAN 1/2 TON, C15 / C1500 Todos	
R	92-99	SUBURBAN 1/2 TON, K15 / K1500 Todos	
R	92-99	SUBURBAN 3/4 TON, C25 / C2500 Todos	
R	92-99	SUBURBAN 3/4 TON, K25 / K2500 Todos	
R	95-00	TAHOE Todos Old Body Style	
R	96-02	VAN 1/2 TON, G / EXPRESS Todos	
R	97-02	VAN 1 TON, G / EXPRESS Todos	
R	96	VAN 1 TON, G / EXPRESS Todos Exc. PBV 8600 #	
R	96-02	VAN 3/4 TON, G / EXPRESS Todos Exc. PBV 8600 #	
R	92-99	<b>GMC</b> SUBURBAN 1/2 TON, C15 / C1500 Todos	
R	92-99	SUBURBAN 1/2 TON, K15 / K1500 Todos	
R	92-99	SUBURBAN 3/4 TON, C25 / C2500 Todos	
R	92-99	SUBURBAN 3/4 TON, K25 / K2500 Todos	
R	96-02	VAN 1/2 TON, G / SAVANNA Todos	
R	96-02	VAN 1 TON, G / SAVANNA Todos Exc. PBV 8600 #	
R	96-02	VAN 3/4 TON, G / SAVANNA Todos Exc. PBV 8600 #	
R	92-99	YUKON Todos	
R	99	YUKON Denali	
61568	W		
R	89	<b>DODGE</b> RAIDER 3.0L 6Cyl V (181) 3.0L 6Cyl	
61569	W		140780
F	90-97	<b>FORD</b> AEROSTAR 4x4	
F	90-97	AEROSTAR AWD	
61573	B		
R	90-97	<b>FORD</b> RANGER 4x4	
R	89	RANGER 4x4 Opción High Ryder	
R	95-96	<b>MAZDA</b> B2300 4x4	
61575	C		
R	93-98	<b>JEEP</b> GRAND CHEROKEE Todos	
61582	C		
R	93-98	<b>TOYOTA</b> T100 4x4	
61588	W		140921
R	90-95	<b>TOYOTA</b> 4RUNNER Todos	
61590	C		140719
R	91-94	<b>FORD</b> EXPLORER Todos	
61591	B		140780
F	91-94	<b>FORD</b> EXPLORER Todos	
F	92-11	VAN 1/2 TON, ECONOLINE / CLUB WAGON Todos	

## Amortiguadores ProGuard

Amort.	POP	No. Alternativo	Montaje Accesorio
Pos.	Año	Aplicación	
61591	B	-continued	140780
F	92-11	VAN 1 TON, ECONOLINE / CLUB WAGON / SUPERDUTY Todos	
F	04-05	VAN 3/4 TON, ECONOLINE / CLUB WAGON / SUPERDUTY Todos	
F	92-02	VAN 3/4 TON, ECONOLINE / CLUB WAGON / SUPERDUTY Todos	
61593	C		140524
F	86-87	<b>MAZDA</b> B2000 4x2 Tracción trasera	
F	87-93	B2200 4x2 Tracción trasera	
F	87-93	B2600 4x2 Tracción trasera	
F	87-90	<b>MITSUBISHI</b> VAN Todos	
61595	D		140780
R	92-11	<b>FORD</b> VAN 1/2 TON, ECONOLINE / CLUB WAGON Todos	
61596	W		140524
F	87-93	<b>MAZDA</b> B2600 4x4	
61597	W		140169
R	87-93	<b>MAZDA</b> B2600 4x4	
61599	B		143000
F	94-01	<b>DODGE</b> PICKUP 1/2 TON, RAM 1500 4x2 Tracción trasera	
F	94-02	PICKUP 1 TON, RAM 3500 4x2 Tracción trasera Exc. Eje Delantero Rígido	
F	94-02	PICKUP 3/4 TON, RAM 2500 4x2 Tracción trasera	
F	99-01	RAMCHARGER Todos	
61600	A		
R	07	<b>CHEVROLET</b> PICKUP 1/2 TON, SILVERADO 1500 Classic Hybrid, 4x2 Tracción trasera Exc. Suspensión Electrónica Ajustable	
R	07	PICKUP 1/2 TON, SILVERADO 1500 Classic LS, 4x2 Tracción trasera Exc. Suspensión Electrónica Ajustable	
R	07	PICKUP 1/2 TON, SILVERADO 1500 Classic LT, 4x2 Tracción trasera Exc. Suspensión Electrónica Ajustable	
R	07	PICKUP 1/2 TON, SILVERADO 1500 Classic SS, 4x2 Tracción trasera Exc. Suspensión Electrónica Ajustable	
R	07	PICKUP 1/2 TON, SILVERADO 1500 Classic WT, 4x2 Tracción trasera Exc. Suspensión Electrónica Ajustable	
R	99-06	PICKUP 1/2 TON, SILVERADO 1500 4x2 Tracción trasera Exc. Suspensión Electrónica Ajustable	
R	00-02	SONORA Todos	
R	94-01	<b>DODGE</b> PICKUP 1/2 TON, RAM 1500 Todos	
R	94-02	PICKUP 1 TON, RAM 3500 4x2 Tracción trasera Exc. Eje Delantero Rígido	
R	94-03	PICKUP 3/4 TON, RAM 2500 4x4, GAS Exc. PBV 8600 #	
R	94-02	PICKUP 3/4 TON, RAM 2500 4x2 Tracción trasera	
R	95-96	PICKUP 3/4 TON, RAM 2500 4x4, CNG Exc. PBV 8600 #	
R	99-01	RAMCHARGER Todos	
R	07	<b>GMC</b> SIERRA 1500 Classic Hybrid, 4x2 Tracción trasera Exc. Suspensión Electrónica Ajustable	
R	07	SIERRA 1500 Classic SL, 4x2 Tracción trasera Exc. Suspensión Electrónica Ajustable	
R	07	SIERRA 1500 Classic SLE, 4x2 Tracción trasera Exc. Suspensión Electrónica Ajustable	
R	07	SIERRA 1500 Classic SLT, 4x2 Tracción trasera Exc. Suspensión Electrónica Ajustable	
R	07	SIERRA 1500 Classic WT, 4x2 Tracción trasera Exc. Suspensión Electrónica Ajustable	
R	99-06	SIERRA 1500 4x2 Tracción trasera Exc. Suspensión Electrónica Ajustable	
61606	W		140673
F	01-04	<b>TOYOTA</b> TACOMA S-Runner Exc. Off Road Package	
F	04	TACOMA Base, 4x2 Tracción trasera Exc. Off Road Package	

## Lista numérica

Amort.	POP	No. Alternativo	Montaje Accesorio
Pos.	Año	Aplicación	
61606	W	-continued	140673
F	95-03	TACOMA DLX, 4x2 Tracción trasera Exc. Off Road Package	
61611	A		142731
F	97-02	<b>FORD</b> EXPEDITION 4x2 Tracción trasera Exc. Nivelación Nuemática Delantera	
F	97-04	PICKUP 1/2 TON, F-150 4x2 Tracción trasera	
F	96-99	PICKUP 3/4 TON, F-250 / SUPERDUTY 4x2 Tracción trasera Hasta PBV 8500#	
F	98-02	<b>LINCOLN</b> NAVIGATOR Coil (FrontSpringType)	
61612	B		142700
R	97-04	<b>FORD</b> PICKUP 1/2 TON, F-150 4x4 Exc. PBV 7700#	
R	97-99	PICKUP 3/4 TON, F-250 / SUPERDUTY 4x4 Hasta PBV 8500#, Exc. Superduty	
61613	B		142731
F	97-02	<b>FORD</b> EXPEDITION 4x4 Exc. Nivelación Nuemática Delantera	
F	04	PICKUP 1/2 TON, F-150 4x4 Exc. PBV 7700#	
F	97-03	PICKUP 1/2 TON, F-150 4x4	
F	97-99	PICKUP 3/4 TON, F-250 / SUPERDUTY 4x4 Hasta PBV 8500#, Exc. Superduty	
61614	C		
R	97-02	<b>FORD</b> EXPEDITION Todos	
R	86-90	F-200	
F	65-78	F-350 PICKUP	
F	86-97	PICKUP 1 TON, F-350 / SUPERDUTY 4x4	
F	97	PICKUP 3/4 TON, F-250 / SUPERDUTY 4x4 PBV arriba de 8500#	
F	87-96	PICKUP 3/4 TON, F-250 / SUPERDUTY 4x4	
R	98-02	<b>LINCOLN</b> NAVIGATOR 4x2 Tracción trasera	
61615	C		141665
F	97-06	<b>JEEP</b> WRANGLER TJ (Código plataforma del fabricante)	
61616	C		
R	97-06	<b>JEEP</b> WRANGLER TJ (Código plataforma del fabricante)	
61623	A		142277
F	95-01	<b>FORD</b> EXPLORER Todos Exc. Suspensión Electrónica Ajustable	
F	01-05	EXPLORER SPORT TRAC Todos	
F	06-11	RANGER 4x2 Tracción trasera, Barra de Torsion (FrontSpringType)	
F	98-11	RANGER 4x4	
F	01-05	RANGER Edge, 4x2 Tracción trasera	
F	03-06	<b>MAZDA</b> B3000 Todos 4x4	
F	98-02	B3000 4x4	
F	98-06	B4000 4x4	
61624	C		140719
R	95-01	<b>FORD</b> EXPLORER Todos Exc. Suspensión de Aire	
R	98	EXPLORER Todos	
R	01-05	EXPLORER SPORT TRAC Todos	
61626	B		141665
F	06-11	<b>FORD</b> RANGER 4x2 Tracción trasera, Coil (FrontSpringType)	
F	98-05	RANGER XL, 4x2 Tracción trasera	
F	98-05	RANGER XLT, 4x2 Tracción trasera	
F	05	RANGER STX, 4x2 Tracción trasera	
F	04	RANGER Tremor, 4x2 Tracción trasera	
F	01-06	<b>MAZDA</b> B2300 4x2 Tracción trasera	
F	98-01	B2500 4x2 Tracción trasera	
F	98-06	B3000 4x2 Tracción trasera	
F	98-06	B4000 4x2 Tracción trasera	
61627	B		
R	06-11	<b>FORD</b> RANGER 4x2 Tracción trasera, Coil (FrontSpringType)	
R	98-05	RANGER XL, 4x2 Tracción trasera	
R	98-05	RANGER XLT, 4x2 Tracción trasera	
R	05	RANGER STX, 4x2 Tracción trasera	
R	04	RANGER Tremor, 4x2 Tracción trasera	
R	01-06	<b>MAZDA</b> B2300 4x2 Tracción trasera	

Lista numérica

Amort.	POP	No. Alternativo	Montaje Accesorio
Pos.	Año	Aplicación	
<b>61627</b>	B	-continued	
R	98-01	B2500 4x2	Tracción trasera
R	98-06	B3000 4x2	Tracción trasera
R	98-06	B4000 4x2	Tracción trasera
<b>61629</b>	C		
R	06-11	<b>FORD RANGER</b> 4x2	Tracción trasera, Barra de Torsion (FrontSpringType)
R	98-11	RANGER	4x4
R	01-05	RANGER Edge,	4x2 Tracción trasera
R	03-06	<b>MAZDA</b> B3000	Todos 4x4
R	98-02	B3000	4x4
R	98-06	B4000	4x4
<b>61632</b>	W		
F	81-93	<b>DODGE</b> PICKUP 1/2 TON, W100	SERIES Todos Exc. Kit de Levantamiento
F	61-80	PICKUP 1/2 TON, W100	SERIES Todos
F	81-93	PICKUP 1 TON, W300	SERIES Todos Exc. Suspensión Quad y Kit de Levantamiento
F	61-80	PICKUP 1 TON, W300	SERIES Todos
R	61-71	PICKUP 1 TON, W300	SERIES Todos
F	81-93	PICKUP 3/4 TON, W200	SERIES Standard Cab Pickup Exc. Kit de Levantamiento
F	69-80	PICKUP 3/4 TON, W200	SERIES Todos
F	61-67	PICKUP 3/4 TON, W200	SERIES Todos
F	75-93	RAMCHARGER	4x4
F	74	RAMCHARGER	4x4 4x4
F	74-81	<b>PLYMOUTH</b> TRAILDUSTER	4x4
<b>61633</b>	W		
R	81-93	<b>DODGE</b> PICKUP 1/2 TON, W100	SERIES Todos Exc. Kit de Levantamiento
R	72-80	PICKUP 1/2 TON, W100	SERIES Todos
R	81-93	PICKUP 1 TON, W300	SERIES Todos Exc. Suspensión Quad y Kit de Levantamiento
R	72-80	PICKUP 1 TON, W300	SERIES Todos
R	81-93	PICKUP 3/4 TON, W200	SERIES Standard Cab Pickup Exc. Kit de Levantamiento
R	72-80	PICKUP 3/4 TON, W200	SERIES Todos
R	76-93	RAMCHARGER	4x4
R	76-81	<b>PLYMOUTH</b> TRAILDUSTER	4x4
<b>61634</b>	D	142731	
F	94-01	<b>DODGE</b> PICKUP 1/2 TON, RAM	1500 4x4
F	94-02	PICKUP 3/4 TON, RAM	2500 4x4, GAS Exc. PBV 8600 #
F	95-96	PICKUP 3/4 TON, RAM	2500 4x4, CNG Exc. PBV 8600 #
<b>61635</b>	C	142731	
F	94-02	<b>DODGE</b> PICKUP 1 TON, RAM	3500 4x4
F	94-02	PICKUP 1 TON, RAM	3500 4x2 Tracción trasera Eje Delantero Rígido
F	94-02	PICKUP 3/4 TON, RAM	2500 4x4, DIESEL PBV 8800
<b>61638</b>	B	142700	
R	04	<b>FORD</b> PICKUP 1/2 TON, F-150	4x2 Tracción trasera
R	00-03	PICKUP 1/2 TON, F-150	Harley-Davidson Edition, 4x2 Tracción trasera
R	99-03	PICKUP 1/2 TON, F-150	Lariat, 4x2 Tracción trasera
R	99-03	PICKUP 1/2 TON, F-150	XL, 4x2 Tracción trasera
R	99-03	PICKUP 1/2 TON, F-150	XLT, 4x2 Tracción trasera
R	00	PICKUP 1/2 TON, F-150	Base, 4x2 Tracción trasera
R	97-98	PICKUP 1/2 TON, F-150	4x2 Tracción trasera
R	97-99	PICKUP 3/4 TON, F-250 /	SUPERDUTY 4x2 Tracción trasera Hasta PBV 8500#

Amortiguadores ProGuard

Amort.	POP	No. Alternativo	Montaje Accesorio
Pos.	Año	Aplicación	
<b>61641</b>	B	141665	
F	07	<b>CHEVROLET</b> PICKUP 1/2 TON, SILVERADO	1500 Classic Hybrid, 4x2 Tracción trasera Exc. Suspensión Electrónica Ajustable
F	07	PICKUP 1/2 TON, SILVERADO	1500 Classic LS, 4x2 Tracción trasera Exc. Suspensión Electrónica Ajustable
F	07	PICKUP 1/2 TON, SILVERADO	1500 Classic LT, 4x2 Tracción trasera Exc. Suspensión Electrónica Ajustable
F	07	PICKUP 1/2 TON, SILVERADO	1500 Classic SS, 4x2 Tracción trasera Exc. Suspensión Electrónica Ajustable
F	07	PICKUP 1/2 TON, SILVERADO	1500 Classic WT, 4x2 Tracción trasera Exc. Suspensión Electrónica Ajustable
F	99-06	PICKUP 1/2 TON, SILVERADO	1500 4x2 Tracción trasera Exc. Suspensión Electrónica Ajustable
F	00-02	SONORA Todos	
F	07	<b>GMC</b> SIERRA 1500 Classic Hybrid,	4x2 Tracción trasera Exc. Suspensión Electrónica Ajustable
F	07	SIERRA 1500 Classic SL,	4x2 Tracción trasera Exc. Suspensión Electrónica Ajustable
F	07	SIERRA 1500 Classic SLE,	4x2 Tracción trasera Exc. Suspensión Electrónica Ajustable
F	07	SIERRA 1500 Classic SLT,	4x2 Tracción trasera Exc. Suspensión Electrónica Ajustable
F	07	SIERRA 1500 Classic WT,	4x2 Tracción trasera Exc. Suspensión Electrónica Ajustable
F	99-06	SIERRA 1500 4x2	Tracción trasera Exc. Suspensión Electrónica Ajustable
<b>61642</b>	B		
R	00	<b>CHEVROLET</b> K1500	
R	07	PICKUP 1/2 TON, SILVERADO	1500 Classic Hybrid, 4x4 Classic y Old Body Style; Exc. Suspensión Electrónica Ajustable
R	07	PICKUP 1/2 TON, SILVERADO	1500 Classic LS, 4x4 Classic y Old Body Style; Exc. Suspensión Electrónica Ajustable
R	07	PICKUP 1/2 TON, SILVERADO	1500 Classic LT, 4x4 Classic y Old Body Style; Exc. Suspensión Electrónica Ajustable
R	07	PICKUP 1/2 TON, SILVERADO	1500 Classic WT, 4x4 Classic y Old Body Style; Exc. Suspensión Electrónica Ajustable
R	07	PICKUP 1/2 TON, SILVERADO	1500 Classic Hybrid, 4x4 Classic y Old Body Style; Exc. Suspensión Electrónica Ajustable
R	99-06	PICKUP 1/2 TON, SILVERADO	1500 4x4 Classic y Old Body Style; Exc. Suspensión Electrónica Ajustable
R	05-07	PICKUP 1/2 TON, SILVERADO	1500 HD Todos
R	01-03	PICKUP 1/2 TON, SILVERADO	1500 HD Todos
R	77-86	PICKUP 1 TON, K30	Todos
R	90-91	PICKUP 1 TON, R3500	Todos
R	89	PICKUP 1 TON, R3500	Cab & Chassis, 4x2 Tracción trasera
R	89	PICKUP 1 TON, R3500	Crew Cab Pickup, 4x2 Tracción trasera
R	01-09	PICKUP 1 TON, SILVERADO	3500 Todos
R	07-10	PICKUP 1 TON, SILVERADO	3500 HD Todos
R	87-88	PICKUP 1 TON, V30	Todos
R	89-91	PICKUP 1 TON, V3000 /	V3500 Todos
R	99-08	PICKUP 3/4 TON, SILVERADO	2500 Todos
R	01-10	PICKUP 3/4 TON, SILVERADO	2500 HD Todos
R	94-02	<b>DODGE</b> PICKUP 1 TON, RAM	3500 4x4
R	94-02	PICKUP 1 TON, RAM	3500 4x2 Tracción trasera Eje Delantero Rígido
R	94-02	PICKUP 3/4 TON, RAM	2500 4x4, DIESEL PBV 8800

Lista numérica

Amort.	POP	No. Alternativo	Montaje Accesorio
Pos.	Año	Aplicación	
<b>61642</b>	B	-continued	
R	77-86	<b>GMC</b> PICKUP 1 TON, K35 /	K3500 Todos
R	87-91	PICKUP 1 TON, V3000 /	V3500 Todos
R	07	SIERRA 1500 Classic Hybrid,	4x4 Classic y Old Body Style; Exc. Suspensión Electrónica Ajustable
R	07	SIERRA 1500 Classic SL,	4x4 Classic y Old Body Style; Exc. Suspensión Electrónica Ajustable
R	07	SIERRA 1500 Classic SLE,	4x4 Classic y Old Body Style; Exc. Suspensión Electrónica Ajustable
R	07	SIERRA 1500 Classic SLT,	4x4 Classic y Old Body Style; Exc. Suspensión Electrónica Ajustable
R	07	SIERRA 1500 Classic WT,	4x4 Classic y Old Body Style; Exc. Suspensión Electrónica Ajustable
R	99-06	SIERRA 1500 4x4	Classic y Old Body Style; Exc. Suspensión Electrónica Ajustable
R	05-07	SIERRA 1500 HD	Todos
R	01-03	SIERRA 1500 HD	Todos
R	99-04	SIERRA 2500	Todos
R	01-10	SIERRA 2500 HD	Todos
R	01-07	SIERRA 3500	Todos
R	07-10	SIERRA 3500 HD	Todos
<b>61643</b>	A	141665	
F	02-06	<b>CHEVROLET</b> AVALANCHE	1500 Todos Exc. Control de Manejo Electrónico
F	07	PICKUP 1/2 TON, SILVERADO	1500 Classic Hybrid, 4x4 Classic y Old Body Style; Exc. Suspensión Electrónica Ajustable
F	07	PICKUP 1/2 TON, SILVERADO	1500 Classic LS, 4x4 Classic y Old Body Style; Exc. Suspensión Electrónica Ajustable
F	07	PICKUP 1/2 TON, SILVERADO	1500 Classic LT, 4x4 Classic y Old Body Style; Exc. Suspensión Electrónica Ajustable
F	07	PICKUP 1/2 TON, SILVERADO	1500 Classic WT, 4x4 Classic y Old Body Style; Exc. Suspensión Electrónica Ajustable
F	99-06	PICKUP 1/2 TON, SILVERADO	1500 4x4 Classic y Old Body Style; Exc. Suspensión Electrónica Ajustable
F	00-06	SUBURBAN 1/2 TON, 1500	Todos Exc. Suspensión Z55 Auto Ride
F	02-06	TAHOE Todos	Exc. Suspensión Z55 Auto Ride
F	00-01	TAHOE Todos	Estilo New Body, Exc. Suspensión Z55
F	07	<b>GMC</b> SIERRA 1500 Classic Hybrid,	4x4 Classic y Old Body Style; Exc. Suspensión Electrónica Ajustable
F	07	SIERRA 1500 Classic SL,	4x4 Classic y Old Body Style; Exc. Suspensión Electrónica Ajustable
F	07	SIERRA 1500 Classic SLE,	4x4 Classic y Old Body Style; Exc. Suspensión Electrónica Ajustable
F	07	SIERRA 1500 Classic SLT,	4x4 Classic y Old Body Style; Exc. Suspensión Electrónica Ajustable
F	07	SIERRA 1500 Classic WT,	4x4 Classic y Old Body Style; Exc. Suspensión Electrónica Ajustable
F	99-06	SIERRA 1500 4x4	Classic y Old Body Style; Exc. Suspensión Electrónica Ajustable
F	00-06	YUKON Todos	Exc. Suspensión Z55 Auto Ride
F	00-06	YUKON XL 1/2 TON	Todos Exc. Suspensión Z55 Auto Ride
<b>61646</b>	C	142617	
R	99-02	<b>FORD</b> ECONOLINE WAGON	
R	04-11	VAN 1 TON, ECONOLINE /	CLUB WAGON / SUPERDUTY Todos Exc. Paquete de Ambulancia & Manejo
R	92-05	VAN 1 TON, ECONOLINE /	CLUB WAGON / SUPERDUTY Todos
R	92-11	VAN 3/4 TON, ECONOLINE /	CLUB WAGON / SUPERDUTY Todos



## Lista numérica

Amort.	POP	No. Alternativo	Montaje Accesorio
Pos.	Año	Aplicación	
<b>61647</b>	D		140126
R	76-79	<b>FORD</b> PICKUP 1/2 TON, F-150 4x4 Exc. Kit de Levantamiento	
R	75	PICKUP 1/2 TON, F-150 Todos 4x4; Exc. Kit de Levantamiento	
R	79	PICKUP 1 TON, F-350 / SUPERDUTY 4x4	
R	75-91	VAN 1 TON, ECONOLINE / CLUB WAGON / SUPERDUTY Todos Exc. Conversión Motorhome	
R	75-91	VAN 3/4 TON, ECONOLINE / CLUB WAGON / SUPERDUTY Todos	
<b>61649</b>	W		
R	73-86	<b>CHEVROLET</b> PICKUP 1 TON, C30 Todos	
R	88-91	PICKUP 1 TON, C35/3500 Cab & Chassis Exc. Eje Rígido Delantero HD	
R	87-88	PICKUP 1 TON, R30 Todos	
R	89	PICKUP 1 TON, R3500 Standard Cab Pickup	
R	73-74	PICKUP 3/4 TON, C20 Todos Crew Cab Pickup	
R	88	PICKUP 3/4 TON, R20 Todos	
R	87	PICKUP 3/4 TON, R20 Crew Cab Pickup	
R	89	PICKUP 3/4 TON, R2500 Todos	
R	74-80	VAN 1/2 TON, P SERIES Todos	
R	79-89	VAN 3/4 TON, P SERIES Todos	
R	88-91	<b>GMC</b> PICKUP 1 TON, C35/3500 Cab & Chassis Exc. Eje Rígido Delantero HD	
R	73-78	PICKUP 1 TON, C35/3500 Todos	
R	87-91	PICKUP 1 TON, R3500 Todos	
R	85-86	PICKUP 3/4 TON, C25 / C2500 Crew Cab Pickup	
R	75-83	PICKUP 3/4 TON, C25 / C2500 Crew Cab Pickup	
R	73-74	PICKUP 3/4 TON, C25 / C2500 Todos Crew Cab	
R	87-89	PICKUP 3/4 TON, R2500 Crew Cab Pickup	
R	74-80	VAN 1/2 TON, P SERIES Todos	
R	73-99	VAN 1 TON, P SERIES Todos	
R	79-89	VAN 3/4 TON, P SERIES Todos	
<b>61650</b>	C		140126
F	72-93	<b>DODGE</b> PICKUP 1 TON, D300 SERIES Todos Paquete HD	
F	82-93	PICKUP 3/4 TON, D200 SERIES Todos Paquete HD	
F	81	PICKUP 3/4 TON, D200 SERIES 165.0 (WheelBase) Paquete HD	
F	77-80	PICKUP 3/4 TON, D200 SERIES Todos Paquete HD	
F	75-76	PICKUP 3/4 TON, D200 SERIES 165.0 (WheelBase) Paquete HD	
F	72-74	PICKUP 3/4 TON, D200 SERIES Todos Paquete HD	
F	71-93	VAN 1 TON, A / B SERIES / RAM Todos Con Eje Delantero 4000#	
F	74-80	VAN, CB300 Todos Con Eje Delantero 4000#	
F	74-83	<b>PLYMOUTH</b> VAN 1 TON, PB SERIES Todos Con Eje Delantero 4000#	
<b>61653</b>	W		
F	96-04	<b>FORD</b> F-350 PICKUP	
<b>61654</b>	C		
R	99-04	<b>FORD</b> PICKUP 1 TON, F-350 / SUPERDUTY 4x2 Tracción trasera	
R	99-04	PICKUP 3/4 TON, F-250 / SUPERDUTY 4x2 Tracción trasera	
<b>61655</b>	W		
R	02	<b>FORD</b> E-550 ECONOLINE SUPER DUTY Todos	
R	03	E-550 SUPER DUTY Todos	
F	99-04	PICKUP 1 TON, F-350 / SUPERDUTY 4x4	
F	99-04	PICKUP 3/4 TON, F-250 / SUPERDUTY 4x4	
F	99-04	PICKUP, F-450 SUPERDUTY Todos	
F	99-04	PICKUP, F-550 SUPERDUTY Todos	
<b>61656</b>	W		
R	99-04	<b>FORD</b> PICKUP 1 TON, F-350 / SUPERDUTY 4x4	
R	99-04	PICKUP 3/4 TON, F-250 / SUPERDUTY 4x4	

## Amortiguadores ProGuard

Amort.	POP	No. Alternativo	Montaje Accesorio
Pos.	Año	Aplicación	
<b>61657</b>	D		
R	99-04	<b>FORD</b> PICKUP, F-450 SUPERDUTY Todos	
R	99-04	PICKUP, F-550 SUPERDUTY Todos	
<b>61662</b>	B		142389
F	00-04	<b>NISSAN</b> FRONTIER Crew Cab Pickup, 4x2 Tracción trasera con Desert Runner	
F	98-04	FRONTIER 4x4	
F	98-99	FRONTIER 4x2 Tracción trasera Crew Cab con Desert Runner	
<b>61663</b>	B		141665
F	02-06	<b>CHEVROLET</b> AVALANCHE 2500 Todos Exc. Control de Manejo Electrónico	
F	05-07	PICKUP 1/2 TON, SILVERADO 1500 HD Todos	
F	01-03	PICKUP 1/2 TON, SILVERADO 1500 HD Todos	
F	01-09	PICKUP 1 TON, SILVERADO 3500 Todos	
F	07-10	PICKUP 1 TON, SILVERADO 3500 HD Todos	
F	05-08	PICKUP 3/4 TON, SILVERADO 2500 Todos	
F	99-04	PICKUP 3/4 TON, SILVERADO 2500 4x4	
F	01-10	PICKUP 3/4 TON, SILVERADO 2500 HD Todos PBV 9200	
F	00-11	SUBURBAN 3/4 TON, 2500 Todos Exc. Suspensión Auto Ride Z55 y Quadrateer	
F	05-07	<b>GMC</b> SIERRA 1500 HD Todos	
F	01-03	SIERRA 1500 HD Todos	
F	99-04	SIERRA 2500 4x4	
F	01-10	SIERRA 2500 HD Todos	
F	01-07	SIERRA 3500 Todos	
F	07-10	SIERRA 3500 HD Barra de Torsion (FrontSpringType)	
F	00-06	YUKON XL 3/4 TON Todos Exc. Sistema de Autonivelación NIVOMAT	
F	03-06	<b>HUMMER</b> H2 Todos	
<b>61664</b>	C		141353,142592
F	99-04	<b>JEEP</b> GRAND CHEROKEE Todos Exc. Suspensión Up Country	
<b>61665</b>	W		
R	94-98	<b>DODGE</b> RAM WAGON	
<b>61668</b>	W		140780
F	94-98	<b>DODGE</b> RAM WAGON	
<b>61669</b>	W		140115
R	94-98	<b>FORD</b> F-600	
<b>61670</b>	W		
F	95-99	<b>DODGE</b> RAM 6500	
<b>61671</b>	W		140115
F	94-98	<b>FORD</b> F-700	
<b>61672</b>	W		140115
R	94-98	<b>FORD</b> F-700	
<b>61675</b>	C		
R	02-10	<b>CADILLAC</b> ESCALADE Todos Exc. Control de Manejo Electrónico	
R	03-10	ESCALADE ESV Todos Exc. Control de Manejo Electrónico	
R	02-10	ESCALADE EXT Todos Exc. Control de Manejo Electrónico	
R	07-11	<b>CHEVROLET</b> AVALANCHE 1500 Todos Exc. Suspensión Z55 o ZW7	
R	02-06	AVALANCHE 1500 Todos Exc. Control de Manejo Electrónico	
R	02-06	AVALANCHE 2500 Todos Exc. Control de Manejo Electrónico	
R	07-11	SUBURBAN 1/2 TON, 1500 Todos Exc. Suspensión Z55 o ZW7	
R	00-06	SUBURBAN 1/2 TON, 1500 Todos Exc. Suspensión Z55 Auto Ride	
R	00-11	SUBURBAN 3/4 TON, 2500 Todos Exc. Suspensión Auto Ride Z55 y Quadrateer	
R	07-11	TAHOE Todos Exc. Suspensión Z55 o ZW7	
R	02-06	TAHOE Todos Exc. Suspensión Z55 Auto Ride	
R	00-01	TAHOE Todos Estilo New Body, Exc. Suspensión Z55	
R	07-11	<b>GMC</b> YUKON Todos Exc. Suspensión Z55 o ZW7	

## Lista numérica

Amort.	POP	No. Alternativo	Montaje Accesorio
Pos.	Año	Aplicación	
<b>61675</b>	C		-continued
R	00-06	YUKON Todos Exc. Suspensión Z55 Auto Ride	
R	00-11	YUKON XL 1/2 TON Todos Exc. Suspensión Z55 Auto Ride	
R	00-11	YUKON XL 3/4 TON Todos Exc. Sistema de Autonivelación NIVOMAT	
<b>61676</b>	C		
R	99-04	<b>JEEP</b> GRAND CHEROKEE Todos	
<b>61680</b>	D		142731
F	05-12	<b>FORD</b> PICKUP 1 TON, F-350 / SUPERDUTY 4x4	
F	05-12	PICKUP 3/4 TON, F-250 / SUPERDUTY 4x4	
<b>61681</b>	D		
R	05-07	<b>FORD</b> PICKUP 1 TON, F-350 / SUPERDUTY Crew Cab Pickup, 4x4 Doble Rodada Trasera	
R	05-07	PICKUP 1 TON, F-350 / SUPERDUTY Extended Cab Pickup, 4x4 Doble Rodada Trasera	
R	05-07	PICKUP 1 TON, F-350 / SUPERDUTY Standard Cab Pickup, 4x4 Doble Rodada Trasera	
<b>61682</b>	D		
R	05-12	<b>FORD</b> PICKUP 1 TON, F-350 / SUPERDUTY Crew Cab Pickup, 4x4 Rodada Trasera Sencilla	
R	05-12	PICKUP 1 TON, F-350 / SUPERDUTY Extended Cab Pickup, 4x4 Rodada Trasera Sencilla	
R	05-12	PICKUP 1 TON, F-350 / SUPERDUTY Standard Cab Pickup, 4x4 Rodada Trasera Sencilla	
R	05-12	PICKUP 3/4 TON, F-250 / SUPERDUTY 4x4	
<b>61683</b>	D		143276
F	03-06	<b>CHEVROLET</b> VAN 1/2 TON, G / EXPRESS Barra de Torsion (FrontSpringType)	
F	06-12	VAN 3/4 TON, G / EXPRESS Todos Barra de Torsion (Suspensión de Resorte Delantero)	
F	03-05	VAN 3/4 TON, G / EXPRESS Barra de Torsion (FrontSpringType)	
F	04-06	<b>GMC</b> VAN 1/2 TON, G / SAVANNA Barra de Torsion (FrontSpringType)	
F	03	VAN 1/2 TON, G / SAVANNA Barra de Torsion (FrontSpringType) Barra de Torsion (Suspensión de Resorte Delantero)	
F	06-12	VAN 3/4 TON, G / SAVANNA Todos Barra de Torsion (Suspensión de Resorte Delantero)	
F	03-05	VAN 3/4 TON, G / SAVANNA Barra de Torsion (FrontSpringType)	
<b>61684</b>	D		143276
F	03-06	<b>CHEVROLET</b> VAN 1/2 TON, G / EXPRESS 4x2 Tracción trasera, Coil (FrontSpringType)	
F	03-06	<b>GMC</b> VAN 1/2 TON, G / SAVANNA 4x2 Tracción trasera, Coil (FrontSpringType)	
<b>61685</b>	C		143078
F	03-12	<b>CHEVROLET</b> VAN 1 TON, G / EXPRESS Coil (FrontSpringType)	
F	03-12	VAN 3/4 TON, G / EXPRESS Coil (FrontSpringType)	
F	03-12	<b>GMC</b> VAN 1 TON, G / SAVANNA Coil (FrontSpringType)	
F	03-12	VAN 3/4 TON, G / SAVANNA Coil (FrontSpringType)	
<b>61686</b>	D		
R	03-11	<b>CHEVROLET</b> VAN 1/2 TON, G / EXPRESS Todos	
R	03-11	<b>GMC</b> VAN 1/2 TON, G / SAVANNA Todos	
<b>61687</b>	D		
R	03-12	<b>CHEVROLET</b> VAN 1 TON, G / EXPRESS Todos Rodada Trasera Sencilla	
R	03-12	VAN 3/4 TON, G / EXPRESS Todos	
R	03-12	<b>GMC</b> VAN 1 TON, G / SAVANNA Todos Con Rodado Sencilla	
R	03-12	VAN 3/4 TON, G / SAVANNA Todos	

Lista numérica

Amortiguadores ProGuard, Amortiguadores para Camioneta Ultra

Lista numérica

Amort.	POP	No. Alternativo	Montaje Accesorio
Pos.	Año	Aplicación	
<b>61688</b>	W		
R	03-06	<b>CHEVROLET</b> VAN 1 TON, G / EXPRESS Todos Doble Rodada Trasera	
R	03-06	<b>GMC</b> VAN 1 TON, G / SAVANNA Todos Doble Rodada Trasera	
<b>61690</b>	C		
R	07-14	<b>CHEVROLET</b> CHEYENNE	
R	08-13	PICKUP 1/2 TON, SILVERADO 1500 Todos Exc. Suspensión Electrónica Ajustable	
R	07	PICKUP 1/2 TON, SILVERADO 1500 Base Exc. Suspensión Electrónica Ajustable	
R	07	PICKUP 1/2 TON, SILVERADO 1500 LS Exc. Suspensión Electrónica Ajustable	
R	07	PICKUP 1/2 TON, SILVERADO 1500 LT Exc. Suspensión Electrónica Ajustable	
R	07	PICKUP 1/2 TON, SILVERADO 1500 LTZ Exc. Suspensión Electrónica Ajustable	
R	07	PICKUP 1/2 TON, SILVERADO 1500 WT Exc. Suspensión Electrónica Ajustable	
R	08-13	<b>GMC</b> SIERRA 1500 Todos Exc. Suspensión Electrónica Ajustable	
R	07	SIERRA 1500 Denali Susp. Elec. Ajustable	
R	07	SIERRA 1500 SLE Exc. Suspensión Electrónica Ajustable	
R	07	SIERRA 1500 SLT Exc. Suspensión Electrónica Ajustable	
R	07	SIERRA 1500 WT Exc. Suspensión Electrónica Ajustable	
<b>61691</b>	D		
R	06-08	<b>DODGE</b> PICKUP 1/2 TON, RAM 1500 Crew Cab Pickup, 4x4	
R	06-08	PICKUP 1/2 TON, RAM 1500 Standard Cab Pickup, 4x4	
R	02-05	PICKUP 1/2 TON, RAM 1500 4x4	
<b>61692</b>	D		
R	06-08	<b>DODGE</b> PICKUP 1/2 TON, RAM 1500 Crew Cab Pickup, 4x2 Tracción trasera	
R	06-08	PICKUP 1/2 TON, RAM 1500 Standard Cab Pickup, 4x2 Tracción trasera	
R	02-05	PICKUP 1/2 TON, RAM 1500 4x2 Tracción trasera	
<b>61693</b>	N		
R	05-06	<b>FORD</b> PICKUP, F-450 SUPERDUTY 4x2 Tracción trasera	
R	05-06	PICKUP, F-550 SUPERDUTY 4x2 Tracción trasera	
<b>61694</b>	N		
R	05-06	<b>FORD</b> PICKUP, F-450 SUPERDUTY 4x4	
R	05-06	PICKUP, F-550 SUPERDUTY 4x4	
<b>61696</b>	D		
R	07-12	<b>JEEP</b> WRANGLER Todos Exc. Ruedas de 17"	
<b>61697</b>	D		
R	07-12	<b>JEEP</b> WRANGLER Todos Ruedas de 17"	
<b>61699</b>	D		140149
R	98-04	<b>TOYOTA</b> TACOMA Pre Runner Izquierdo	
<b>61700</b>	D		140149
R	98-04	<b>TOYOTA</b> TACOMA Pre Runner Derecho	
<b>61703</b>	W		
R	98-02	<b>LINCOLN</b> NAVIGATOR 4x4, Air (RearSpringType)	
<b>61709</b>	W		
R	03-06	<b>DODGE</b> PICKUP 1 TON, RAM 3500 Standard Cab Pickup, 4x2 Tracción trasera	
R	03-06	PICKUP 3/4 TON, RAM 2500 Standard Cab Pickup, 4x2 Tracción trasera	

Amort.	POP	No. Alternativo	Montaje Accesorio
Pos.	Año	Aplicación	
<b>61710</b>	C		
R	03-07	<b>DODGE</b> PICKUP 1 TON, RAM 3500 Crew Cab Pickup, 4x2 Tracción trasera	
R	03-06	PICKUP 3/4 TON, RAM 2500 Crew Cab Pickup, 4x2 Tracción trasera	
<b>61711</b>	W		142973
F	07-12	<b>JEEP</b> WRANGLER Todos	
<b>61712</b>	D		142731
F	06-08	<b>DODGE</b> PICKUP 1/2 TON, RAM 1500 4x4 Mega Cab	
<b>61713</b>	D		
R	05-12	<b>FORD</b> PICKUP 1 TON, F-350 / SUPERDUTY 4x2 Tracción trasera	
R	05-12	PICKUP 3/4 TON, F-250 / SUPERDUTY 4x2 Tracción trasera	
<b>61714</b>	C		142731
F	05-08	<b>DODGE</b> PICKUP 3/4 TON, RAM 2500 4x4	
<b>61715</b>	W		
R	06-10	<b>JEEP</b> COMMANDER Todos	
R	05-10	<b>GRAND CHEROKEE</b> Todos	
<b>61716</b>	C		
R	03-10	<b>DODGE</b> PICKUP 3/4 TON, RAM 2500 4x4	
R	11-12	RAM 2500	
R	11-12	<b>RAM</b> 2500 (SEE DODGE RAM 2500) 4x4	
<b>61717</b>	D		
R	06-09	<b>CHEVROLET</b> TRAILBLAZER Air (RearSpringType)	
R	02-05	TRAILBLAZER Todos Suspensión de Resorte de Aire Trasera	
R	02-09	<b>GMC</b> ENVOY Todos	
<b>Amortiguadores para Camioneta Ultra</b>			
<b>G63173</b>	D		
R	93-98	<b>TOYOTA</b> T100 4x2 Tracción trasera	
<b>G63183</b>	D		
R	74	<b>DODGE</b> M300 Todos	
F	81-93	PICKUP 1/2 TON, W100 SERIES Todos Exc. Kit de Levantamiento	
F	61-80	PICKUP 1/2 TON, W100 SERIES Todos	
F	81-93	PICKUP 1 TON, W300 SERIES Todos Exc. Suspensión Quad y Kit de Levantamiento	
F	61-80	PICKUP 1 TON, W300 SERIES Todos	
R	61-71	PICKUP 1 TON, W300 SERIES Todos	
F	81-93	PICKUP 3/4 TON, W200 SERIES Standard Cab Pickup Exc. Kit de Levantamiento	
F	69-80	PICKUP 3/4 TON, W200 SERIES Todos	
F	61-67	PICKUP 3/4 TON, W200 SERIES Todos	
F	74-93	<b>RAMCHARGER</b> 4x4	
F	74-81	<b>PLYMOUTH</b> TRAILDUSTER 4x4	
<b>G63187</b>	W		141138
F	65	<b>FORD</b> F-100	
F	65	PICKUP 1/2 TON, F-100 4x4 Con Resortes de Hojas Delanteros	
F	75-77	PICKUP 3/4 TON, F-250 / SUPERDUTY 4x4 Toda la serie No. Y20000	
F	73-74	PICKUP 3/4 TON, F-250 / SUPERDUTY 4x4 4x4; Toda la serie No. Y20000	
F	61-72	PICKUP 3/4 TON, F-250 / SUPERDUTY Todos 4x4; Toda la serie No. Y20000	
<b>G63299</b>	C		140885
R	61-67	<b>FORD</b> ECONOLINE Todos	
R	53-55	F SERIES Todos	
R	48-52	F SERIES Todos F-1, F-2 & F-3	
F	72-81	<b>JEEP</b> CJ5 Todos Exc. Kit de Levantamiento	
F	73-81	CJ5D	
F	65-71	CJ5D	
F	72-75	CJ6 Todos Exc. Kit de Levantamiento	
F	76-81	CJ7 Todos Exc. Kit de Levantamiento	

Amort.	POP	No. Alternativo	Montaje Accesorio
Pos.	Año	Aplicación	
<b>G63299</b>	C	-continued	140885
F	66-74	DJ5 Todos Exc. Kit de Levantamiento	
F	81	<b>SCRAMBLER</b> / CJ8 Todos	
R	71-74	<b>WAGONEER</b> Todos	
R	63-67	<b>WAGONEER</b> Todos	
<b>G63306</b>	W		
R	69-72	<b>CHEVROLET</b> BLAZER 4x2 Tracción trasera	
R	63-72	PICKUP 1/2 TON, C10 Todos Resorte Trasero de Hojas Múltiples	
R	67-72	PICKUP 1 TON, C30 Todos Exc. Eje Trasero 11,000#	
R	63-72	PICKUP 3/4 TON, C20 Todos	
R	63-66	SUBURBAN 1/2 TON, 1500 Todos	
R	67-77	VAN 1/2 TON, G / EXPRESS Todos	
R	63-66	VAN 1/2 TON, P SERIES Todos	
R	76-77	VAN 1 TON, G / EXPRESS Todos	
R	75	VAN 1 TON, G / EXPRESS 110.0 (WheelBase)	
R	75	VAN 1 TON, G / EXPRESS 125.0 (WheelBase)	
R	71-74	VAN 1 TON, G / EXPRESS Todos	
R	67-77	VAN 3/4 TON, G / EXPRESS Todos	
R	68-72	VAN 3/4 TON, P SERIES Todos	
R	70-72	<b>GMC</b> JIMMY Todos 4x2 Tracción trasera	
R	67-72	PICKUP 1/2 TON, C15 / C1500 Todos 4x2 Tracción trasera	
R	67-72	PICKUP 1 TON, C35/3500 Todos Exc. Eje Trasero 11,000#	
R	67-72	PICKUP 3/4 TON, C25 / C2500 Todos 4x2 Tracción trasera	
R	63-65	PICKUP 1500 SERIES Todos	
R	67-77	VAN 1/2 TON, G / SAVANNA Todos	
R	67	VAN 1/2 TON, P SERIES Todos	
R	76-77	VAN 1 TON, G / SAVANNA Todos	
R	75	VAN 1 TON, G / SAVANNA 110.0 (WheelBase)	
R	75	VAN 1 TON, G / SAVANNA 125.0 (WheelBase)	
R	71-74	VAN 1 TON, G / SAVANNA Todos	
R	68-72	VAN 1 TON, P SERIES Todos Exc. Eje Trasero 11,000#	
R	67-77	VAN 3/4 TON, G / SAVANNA Todos	
R	68-72	VAN 3/4 TON, P SERIES Todos	
R	63-65	VAN, PB 1000 SERIES Todos	
<b>G63347</b>	D		
F	87-91	<b>CHEVROLET</b> BLAZER 4x4 Automóvil Grande; Exc. Suspensión Quad y Kit de Levantamiento	
F	75-86	BLAZER 4x4 Exc. Suspensión Quad y Kit de Levantamiento	
F	73-74	BLAZER 4x4 Exc. Kit de Levantamiento	
F	69-72	BLAZER 4x4	
F	81-86	PICKUP 1/2 TON, K10 Todos Suspensión Estándar; Exc. Kit de Levantamiento	
F	75-80	PICKUP 1/2 TON, K10 Todos Exc. Kit de Levantamiento	
F	73-74	PICKUP 1/2 TON, K10 Todos Exc. Suspensión Quad y Kit de Levantamiento	
F	69-72	PICKUP 1/2 TON, K10 Todos	
F	87	PICKUP 1/2 TON, V10 Todos Exc. Suspensión Quad y Kit de Levantamiento	
F	81-86	PICKUP 3/4 TON, K20 Todos Suspensión Estándar; Exc. Kit de Levantamiento	
F	75-80	PICKUP 3/4 TON, K20 Todos Exc. Kit de Levantamiento	
F	69-74	PICKUP 3/4 TON, K20 Todos Exc. Suspensión Quad y Kit de Levantamiento	
F	87	PICKUP 3/4 TON, V20 Todos Exc. Suspensión Quad y Kit de Levantamiento	
F	81-86	SUBURBAN 1/2 TON, K10 Todos Suspensión Estándar; Exc. Kit de Levantamiento	
F	69-80	SUBURBAN 1/2 TON, K10 Todos Exc. Kit de Levantamiento	
F	81-86	SUBURBAN 3/4 TON, K20 Todos Suspensión Estándar; Exc. Kit de Levantamiento	
F	69-80	SUBURBAN 3/4 TON, K20 Todos Exc. Kit de Levantamiento	
F	87-88	SUBURBAN 3/4 TON, V20 Todos Exc. Suspensión Quad y Kit de Levantamiento	

Lista numérica

Amort.	POP	No. Alternativo	Montaje Accesorio
Pos.	Año	Aplicación	
<b>G63347</b>	D	-continued	140357
F 89-91		SUBURBAN 3/4 TON, V2500 Todos Exc. Suspensión Quad y Kit de Levantamiento	
F 75-91		<b>GMC JIMMY</b> 4x4 Exc. Suspensión Quad y Kit de Levantamiento	
F 70-74		JIMMY Todos 4x4; Exc. Kit de Levantamiento	
F 69-86		PICKUP 1/2 TON, K15 / K1500 Todos Exc. Suspensión Quad y Kit de Levantamiento	
F 87		PICKUP 1/2 TON, V1500 Todos Exc. Kit de Levantamiento	
F 69-86		PICKUP 3/4 TON, K25 / K2500 Todos Exc. Suspensión Quad y Kit de Levantamiento	
F 87		PICKUP 3/4 TON, V2500 Todos Exc. Kit de Levantamiento	
F 69-86		SUBURBAN 1/2 TON, K15 / K1500 Todos Exc. Suspensión Quad y Kit de Levantamiento	
F 87-91		SUBURBAN 1/2 TON, V1500 Todos Exc. Kit de Levantamiento	
F 69-86		SUBURBAN 3/4 TON, K25 / K2500 Todos Exc. Suspensión Quad y Kit de Levantamiento	
F 87-91		SUBURBAN 3/4 TON, V2500 Todos Exc. Kit de Levantamiento	
<b>G63349</b>	B		140357
R 87-91		<b>CHEVROLET</b> BLAZER Todos Automóvil Grande; Exc. Suspensión Quad y Kit de Levantamiento	
R 73-86		BLAZER Todos Exc. Kit de Levantamiento	
R 75-86		PICKUP 1/2 TON, C10 Todos	
R 73-86		PICKUP 1/2 TON, K10 Todos Exc. Suspensión Quad y Kit de Levantamiento	
R 87		PICKUP 1/2 TON, R10 Todos	
R 87		PICKUP 1/2 TON, V10 Todos Exc. Suspensión Quad y Kit de Levantamiento	
R 75-86		PICKUP 3/4 TON, K20 Todos Exc. Suspensión Quad y Kit de Levantamiento	
R 87		PICKUP 3/4 TON, R20 Standard Cab Pickup	
R 87		PICKUP 3/4 TON, V20 Todos Exc. Suspensión Quad y Kit de Levantamiento	
R 73-86		SUBURBAN 1/2 TON, C10 Todos	
R 73-86		SUBURBAN 1/2 TON, K10 Todos Exc. Suspensión Quad y Kit de Levantamiento	
R 87-88		SUBURBAN 1/2 TON, R10 Todos	
R 89-91		SUBURBAN 1/2 TON, R1500 Todos	
R 89-91		SUBURBAN 1/2 TON, V1500 Todos Exc. Suspensión Quad y Kit de Levantamiento	
R 73-86		SUBURBAN 3/4 TON, C20 Todos	
R 73-86		SUBURBAN 3/4 TON, K20 Todos Exc. Suspensión Quad y Kit de Levantamiento	
R 87-88		SUBURBAN 3/4 TON, R20 Todos	
R 89-91		SUBURBAN 3/4 TON, R2500 Todos	
R 87-88		SUBURBAN 3/4 TON, V20 Todos Exc. Suspensión Quad y Kit de Levantamiento	
R 89-91		SUBURBAN 3/4 TON, V2500 Todos Exc. Suspensión Quad y Kit de Levantamiento	
R 73		VAN 1/2 TON, P SERIES Todos	
R 73-78		VAN 3/4 TON, P SERIES Todos	
R 73-91		<b>GMC JIMMY</b> Todos Exc. Kit de Levantamiento	
R 73-86		PICKUP 1/2 TON, C15 / C1500 Todos	
R 73-86		PICKUP 1/2 TON, K15 / K1500 Todos Exc. Kit de Levantamiento	
R 87		PICKUP 1/2 TON, R1500 Todos	
R 87		PICKUP 1/2 TON, V1500 Todos Exc. Kit de Levantamiento	
R 75-86		PICKUP 3/4 TON, C25 / C2500 Cab & Chassis	
R 75-86		PICKUP 3/4 TON, C25 / C2500 Standard Cab Pickup	
R 73-74		PICKUP 3/4 TON, C25 / C2500 Todos Exc. Crew Cab & Bonus Cab	
R 73-86		PICKUP 3/4 TON, K25 / K2500 Todos Exc. Kit de Levantamiento	
R 88-89		PICKUP 3/4 TON, R2500 Todos Exc. Crew Cab & Bonus Cab	

Amortiguadores para Camioneta Ultra

Amort.	POP	No. Alternativo	Montaje Accesorio
Pos.	Año	Aplicación	
<b>G63349</b>	B	-continued	140357
R 87		PICKUP 3/4 TON, R2500 Cab & Chassis Exc. Crew Cab & Bonus Cab	
R 87		PICKUP 3/4 TON, R2500 Standard Cab Pickup Exc. Crew Cab & Bonus Cab	
R 87		PICKUP 3/4 TON, V2500 Todos Exc. Kit de Levantamiento	
R 73-86		SUBURBAN 1/2 TON, C15 / C1500 Todos	
R 73-86		SUBURBAN 1/2 TON, K15 / K1500 Todos Exc. Kit de Levantamiento	
R 87-91		SUBURBAN 1/2 TON, R1500 Todos	
R 87-91		SUBURBAN 1/2 TON, V1500 Todos Exc. Kit de Levantamiento	
R 75-86		SUBURBAN 3/4 TON, C25 / C2500 Todos	
R 73-74		SUBURBAN 3/4 TON, C25 / C2500 Todos Exc. Crew Cab & Bonus Cab	
R 73-86		SUBURBAN 3/4 TON, K25 / K2500 Todos Exc. Kit de Levantamiento	
R 87-91		SUBURBAN 3/4 TON, R2500 Todos	
R 87-91		SUBURBAN 3/4 TON, V2500 Todos Exc. Kit de Levantamiento	
R 73		VAN 1/2 TON, P SERIES Todos	
R 73-78		VAN 3/4 TON, P SERIES Todos	
<b>G63350</b>	C		140126
R 66		<b>FORD</b> BRONCO Todos Toda la serie #830000	
R 73-79		PICKUP 1/2 TON, F-100 4x2 Tracción trasera	
R 70-72		PICKUP 1/2 TON, F-100 Todos 4x2 Tracción trasera	
R 75-79		PICKUP 1/2 TON, F-150 4x2 Tracción trasera	
R 74-79		PICKUP 1 TON, F-350 / SUPERDUTY Extended Cab Pickup, 4x2 Tracción trasera	
R 75-79		PICKUP 3/4 TON, F-250 / SUPERDUTY Cab & Chassis, 4x2 Tracción trasera	
R 75-79		PICKUP 3/4 TON, F-250 / SUPERDUTY Standard Cab Pickup, 4x2 Tracción trasera	
R 70-74		PICKUP 3/4 TON, F-250 / SUPERDUTY 4x2 Tracción trasera Exc. Supercab	
R 75-91		VAN 1/2 TON, ECONLINE / CLUB WAGON Todos	
<b>G63353</b>	C		
R 72-93		<b>DODGE</b> PICKUP 1/2 TON, D100 SERIES Todos	
R 72-93		PICKUP 1 TON, D300 SERIES Todos	
R 72-93		PICKUP 3/4 TON, D200 SERIES Todos	
R 74-93		RAMCHARGER 4x2 Tracción trasera	
R 76-81		<b>PLYMOUTH</b> TRAILDUSTER 4x2 Tracción trasera	
R 74-75		TRAILDUSTER Todos	
<b>G63355</b>	B		140702
F 69-84		<b>CHEVROLET</b> BLAZER 4x2 Tracción trasera	
F 63-86		PICKUP 1/2 TON, C10 Todos	
F 87		PICKUP 1/2 TON, R10 Todos	
F 63-86		PICKUP 1 TON, C30 Todos	
F 88-91		PICKUP 1 TON, C35/3500 Cab & Chassis Exc. Eje Rígido Delantero HD	
F 87-88		PICKUP 1 TON, R30 Todos	
F 89		PICKUP 1 TON, R3500 Standard Cab Pickup	
F 63-74		PICKUP 3/4 TON, C20 Todos	
F 88		PICKUP 3/4 TON, R20 Todos	
F 87		PICKUP 3/4 TON, R20 Crew Cab Pickup	
F 89		PICKUP 3/4 TON, R2500 4x2 Tracción trasera	
F 63-67		SUBURBAN 1/2 TON, 1500 Todos	
F 63-86		SUBURBAN 1/2 TON, C10 Todos	
F 87-88		SUBURBAN 1/2 TON, R10 Todos	
F 89-91		SUBURBAN 1/2 TON, R1500 Todos	
F 68-86		SUBURBAN 3/4 TON, C20 Todos	
F 87-88		SUBURBAN 3/4 TON, R20 Todos	
F 89-91		SUBURBAN 3/4 TON, R2500 Todos	
F 63-80		VAN 1/2 TON, P SERIES Todos	
F 68-89		VAN 3/4 TON, P SERIES Todos	
F 75-84		<b>GMC JIMMY</b> 4x2 Tracción trasera	
F 70-74		JIMMY Todos 4x2 Tracción trasera	

Lista numérica

Amort.	POP	No. Alternativo	Montaje Accesorio
Pos.	Año	Aplicación	
<b>G63355</b>	B	-continued	140702
F 67-86		PICKUP 1/2 TON, C15 / C1500 Todos	
F 87		PICKUP 1/2 TON, R1500 Todos	
F 88-90		PICKUP 1 TON, C35/3500 Cab & Chassis Exc. Eje Rígido Delantero HD	
F 67-78		PICKUP 1 TON, C35/3500 Todos	
F 87-91		PICKUP 1 TON, R3500 Todos	
F 85-86		PICKUP 3/4 TON, C25 / C2500 Crew Cab Pickup	
F 75-86		PICKUP 3/4 TON, C25 / C2500 Cab & Chassis	
F 75-86		PICKUP 3/4 TON, C25 / C2500 Standard Cab Pickup	
F 75-83		PICKUP 3/4 TON, C25 / C2500 Crew Cab Pickup	
F 67-74		PICKUP 3/4 TON, C25 / C2500 Todos	
F 87-89		PICKUP 3/4 TON, R2500 Todos Exc. Crew Cab & Bonus Cab	
F 63-65		PICKUP 1500 SERIES Todos	
F 68-86		SUBURBAN 1/2 TON, C15 / C1500 Todos	
F 87-91		SUBURBAN 1/2 TON, R1500 Todos	
F 68-86		SUBURBAN 3/4 TON, C25 / C2500 Todos	
F 87-91		SUBURBAN 3/4 TON, R2500 Todos	
F 67-80		VAN 1/2 TON, P SERIES Todos	
F 75-90		VAN 1 TON, P SERIES Todos Exc. Chasis Motorhome	
F 73-74		VAN 1 TON, P SERIES Base Exc. Chasis Motorhome	
F 68-72		VAN 1 TON, P SERIES Todos	
F 68-89		VAN 3/4 TON, P SERIES Todos	
F 63-65		VAN, PB 1000 SERIES Todos	
<b>G63357</b>	D		
F 71-95		<b>CHEVROLET</b> VAN 1/2 TON, G / EXPRESS Todos	
F 70		VAN 1/2 TON, G / EXPRESS Todos Suspensión Delantera Independiente	
F 76-95		VAN 1 TON, G / EXPRESS Todos	
F 75		VAN 1 TON, G / EXPRESS 146.0 (WheelBase)	
F 71-74		VAN 1 TON, G / EXPRESS Todos	
F 78-95		VAN 3/4 TON, G / EXPRESS Todos Exc. PBV 8600 #	
F 71-77		VAN 3/4 TON, G / EXPRESS Todos	
F 70		VAN 3/4 TON, G / EXPRESS Todos Suspensión Delantera Independiente	
F 71-95		<b>GMC</b> VAN 1/2 TON, G / SAVANNA Todos	
F 70		VAN 1/2 TON, G / SAVANNA Todos Suspensión Delantera Independiente	
F 76-95		VAN 1 TON, G / SAVANNA Todos	
F 75		VAN 1 TON, G / SAVANNA 146.0 (WheelBase)	
F 71-74		VAN 1 TON, G / SAVANNA Todos	
F 78-95		VAN 3/4 TON, G / SAVANNA Todos Exc. PBV 8600 #	
F 71-77		VAN 3/4 TON, G / SAVANNA Todos	
F 70		VAN 3/4 TON, G / SAVANNA Todos Suspensión Delantera Independiente	
<b>G63359</b>	B		140126
F 72-93		<b>DODGE</b> PICKUP 1/2 TON, D100 SERIES Todos	
F 72-93		PICKUP 3/4 TON, D200 SERIES Todos Exc. Paquete HD	
F 75-93		RAMCHARGER 4x2 Tracción trasera	
F 99-03		VAN 1/2 TON, A / B SERIES / RAM 109.3 (WheelBase) Exc. PBV 7000#	
F 81-98		VAN 1/2 TON, A / B SERIES / RAM 109.6 (WheelBase) Exc. PBV 7000#	
F 71-80		VAN 1/2 TON, A / B SERIES / RAM Todos Exc. Eje Delantero 4000#	
F 99-03		VAN 1 TON, A / B SERIES / RAM Todos	
F 71-98		VAN 1 TON, A / B SERIES / RAM Todos Exc. Eje Delantero 4000#	
F 81-03		VAN 3/4 TON, A / B SERIES / RAM Todos	
F 71-80		VAN 3/4 TON, A / B SERIES / RAM Todos Exc. Eje Delantero 4000#	
F 74-80		VAN, CB300 Todos Exc. Eje Delantero 4000#	
F 75-81		<b>PLYMOUTH</b> TRAILDUSTER 4x2 Tracción trasera	
F 74-83		VAN 1/2 TON, PB SERIES Todos	
F 74-83		VAN 1 TON, PB SERIES Todos Exc. Eje Delantero 4000#	
F 74-83		VAN 3/4 TON, PB SERIES Todos	

Lista numérica

Amort.	POP	No. Alternativo	Montaje Accesorio
Pos.	Año	Aplicación	
<b>G63360</b>	B		140126
F	91-93	<b>DODGE</b> PICKUP 1 TON, D300 SERIES Todos Paquete HD	
F	90	PICKUP 1 TON, D300 SERIES Todos	
F	72-89	PICKUP 1 TON, D300 SERIES Todos Paquete HD	
F	72-93	PICKUP 3/4 TON, D200 SERIES Todos Paquete HD	
F	71-93	VAN 1 TON, A / B SERIES / RAM Todos Con Eje Delantero 4000#	
F	74-80	VAN, CB300 Todos Con Eje Delantero 4000#	
F	74-83	<b>PLYMOUTH</b> VAN 1 TON, PB SERIES Todos Con Eje Delantero 4000#	
<b>G63366</b>	W		
R	75-86	<b>CHEVROLET</b> PICKUP 1 TON, C30 Todos	
R	88-91	PICKUP 1 TON, C35/3500 Cab & Chassis Exc. Eje Rígido Delantero HD	
R	87-88	PICKUP 1 TON, R30 Todos	
R	89	PICKUP 1 TON, R3500 Standard Cab Pickup	
R	88	PICKUP 3/4 TON, R20 Todos	
R	87	PICKUP 3/4 TON, R20 Crew Cab Pickup	
R	89	PICKUP 3/4 TON, R2500 Todos	
R	74-80	VAN 1/2 TON, P SERIES Todos	
R	79-89	VAN 3/4 TON, P SERIES Todos	
R	88-91	<b>GMC</b> PICKUP 1 TON, C35/3500 Cab & Chassis Exc. Eje Rígido Delantero HD	
R	73-78	PICKUP 1 TON, C35/3500 Todos	
R	87-91	PICKUP 1 TON, R3500 Todos	
R	85-86	PICKUP 3/4 TON, C25 / C2500 Crew Cab Pickup	
R	73-83	PICKUP 3/4 TON, C25 / C2500 Crew Cab Pickup	
R	87-89	PICKUP 3/4 TON, R2500 Crew Cab Pickup	
R	74-80	VAN 1/2 TON, P SERIES Todos	
R	73-99	VAN 1 TON, P SERIES Todos	
R	79-89	VAN 3/4 TON, P SERIES Todos	
<b>G63371</b>	W		
R	69-72	<b>CHEVROLET</b> BLAZER 4x4	
R	69-72	PICKUP 1/2 TON, K10 Todos	
R	71-72	PICKUP 3/4 TON, K20 Todos	
R	71-72	SUBURBAN 1/2 TON, K10 Todos	
R	71-72	SUBURBAN 3/4 TON, K20 Todos Exc. Suspensión Quad y Kit de Levantamiento	
R	70-72	<b>GMC</b> JIMMY 4x4	
R	71-72	PICKUP 1/2 TON, K15 / K1500 Todos	
R	71-72	PICKUP 3/4 TON, K25 / K2500 Todos	
R	71-72	SUBURBAN 1/2 TON, K15 / K1500 Todos	
R	71-72	SUBURBAN 3/4 TON, K25 / K2500 Todos	
<b>G63375</b>	A		140780,142615
F	85-05	<b>CHEVROLET</b> ASTRO 4x2 Tracción trasera	
F	83-85	IMPALA Todos Modelos Policía y Taxi	
F	71-82	IMPALA Sedan Modelos Policía y Taxi	
F	96-02	VAN 1/2 TON, G / EXPRESS Todos	
F	97-02	VAN 1 TON, G / EXPRESS Todos	
F	96-02	VAN 3/4 TON, G / EXPRESS Todos Exc. PBV 8600 #	
F	93-02	<b>FORD</b> CROWN VICTORIA Police Interceptor Modelos Policía y Taxi	
F	85-05	<b>GMC</b> SAFARI 4x2 Tracción trasera	
F	96-02	VAN 1/2 TON, G / SAVANNA 4x2 Tracción trasera	
F	96-02	VAN 1 TON, G / SAVANNA Todos	
F	96-02	VAN 3/4 TON, G / SAVANNA Todos Exc. PBV 8600 #	
<b>G63377</b>	C		141137
R	78-79	<b>FORD</b> BRONCO Todos Exc. Kit de Levantamiento	
R	66-77	BRONCO Todos Desde Serie #830001; Exc. Kit de Levantamiento	
R	65-78	F-100	
R	67-78	F-350 PICKUP	
R	66-69	PICKUP 1/2 TON, F-100 4x2 Tracción trasera	

Amortiguadores para Camioneta Ultra

Amort.	POP	No. Alternativo	Montaje Accesorio
Pos.	Año	Aplicación	
<b>G63377</b>	C	-continued	141137
R	65	PICKUP 1/2 TON, F-100 Leaf (FrontSpringType) 4x2 Tracción trasera	
R	75-79	PICKUP 1 TON, F-350 / SUPERDUTY Standard Cab Pickup, 4x2 Tracción trasera	
R	73-74	PICKUP 1 TON, F-350 / SUPERDUTY Todos	
R	75-79	PICKUP 3/4 TON, F-250 / SUPERDUTY Extended Cab Pickup, 4x2 Tracción trasera	
R	65-74	PICKUP 3/4 TON, F-250 / SUPERDUTY 4x2 Tracción trasera Supercab	
R	69-74	VAN 1/2 TON, ECONOLINE / CLUB WAGON Todos	
R	68	VAN 1/2 TON, ECONOLINE / CLUB WAGON Todos A finales de 1968	
R	69-74	VAN 1 TON, ECONOLINE / CLUB WAGON / SUPERDUTY Todos	
R	68	VAN 1 TON, ECONOLINE / CLUB WAGON / SUPERDUTY Todos A finales de 1968	
R	69-74	VAN 3/4 TON, ECONOLINE / CLUB WAGON / SUPERDUTY Todos	
R	68	VAN 3/4 TON, ECONOLINE / CLUB WAGON / SUPERDUTY Todos A finales de 1968	
R	76-83	<b>JEEP</b> CHEROKEE Todos	
F	74-83	CHEROKEE Todos	
F	82-83	CJ5 Todos Exc. Kit de Levantamiento	
F	82-86	CJ5D	
F	82-86	CJ7 Todos Exc. Kit de Levantamiento	
F	84-91	GRAND WAGONEER Todos	
R	84-91	GRAND WAGONEER Todos	
F	74-88	J10 PICKUP Todos	
F	74-88	J10 PICKUP Todos	
F	74-88	J20 PICKUP Todos	
R	74-88	J20 PICKUP Todos	
F	82-85	SCRAMBLER / CJ8 Todos	
R	76-83	WAGONEER Todos	
R	74-83	WAGONEER Todos	
<b>G63386</b>	B		140780
F	85-91	<b>FORD</b> B200	
F	67-77	BRONCO Todos Desde Serie #830001; Exc. Kit de Levantamiento	
F	66	BRONCO Todos Exc. Kit de Levantamiento	
F	65-74	F-100	
F	76-79	PICKUP 1/2 TON, F-100 Todos Exc. Kit de Levantamiento	
F	70-75	PICKUP 1/2 TON, F-100 Todos	
F	65-69	PICKUP 1/2 TON, F-100 4x2 Tracción trasera	
F	75-79	PICKUP 1/2 TON, F-150 4x2 Tracción trasera	
F	75-79	PICKUP 1 TON, F-350 / SUPERDUTY Standard Cab Pickup, 4x2 Tracción trasera	
F	67-74	PICKUP 1 TON, F-350 / SUPERDUTY 4x2 Tracción trasera Exc. Supercab	
F	73-79	PICKUP 3/4 TON, F-250 / SUPERDUTY 4x2 Tracción trasera	
F	65-72	PICKUP 3/4 TON, F-250 / SUPERDUTY Todos 4x2 Tracción trasera	
F	75-91	VAN 1 TON, ECONOLINE / CLUB WAGON / SUPERDUTY Todos Conversión a Motorhome	
F	75-91	VAN 3/4 TON, ECONOLINE / CLUB WAGON / SUPERDUTY Todos	
<b>G63387</b>	D		140126
R	70-76	<b>FORD</b> PICKUP 1/2 TON, F-100 4x4 Exc. Kit de Levantamiento	
R	76-79	PICKUP 1/2 TON, F-150 4x4 Exc. Kit de Levantamiento	
R	75	PICKUP 1/2 TON, F-150 Todos 4x4; Exc. Kit de Levantamiento	
R	79	PICKUP 1 TON, F-350 / SUPERDUTY 4x4	
R	77-79	PICKUP 3/4 TON, F-250 / SUPERDUTY Cab & Chassis, 4x4 Aplica para toda la serie No. Y20001	
R	77-79	PICKUP 3/4 TON, F-250 / SUPERDUTY Standard Cab Pickup, 4x4 Aplica para toda la serie No. Y20001	

Lista numérica

Amort.	POP	No. Alternativo	Montaje Accesorio
Pos.	Año	Aplicación	
<b>G63387</b>	D	-continued	140126
R	75-91	VAN 1 TON, ECONOLINE / CLUB WAGON / SUPERDUTY Todos Conversión a Motorhome	
R	75-91	VAN 3/4 TON, ECONOLINE / CLUB WAGON / SUPERDUTY Todos	
<b>G63389</b>	W		
R	81-93	<b>DODGE</b> PICKUP 1/2 TON, W100 SERIES Todos Exc. Kit de Levantamiento	
R	72-80	PICKUP 1/2 TON, W100 SERIES Todos	
R	81-93	PICKUP 1 TON, W300 SERIES Todos Exc. Suspensión Quad y Kit de Levantamiento	
R	72-80	PICKUP 1 TON, W300 SERIES Todos	
R	81-93	PICKUP 3/4 TON, W200 SERIES Standard Cab Pickup Exc. Kit de Levantamiento	
R	72-80	PICKUP 3/4 TON, W200 SERIES Todos	
R	76-93	RAMCHARGER 4x4	
R	76-81	<b>PLYMOUTH</b> TRAILDUSTER 4x4	
<b>G63394</b>	D		140702
F	85-99	<b>GMC</b> VAN 1 TON, P SERIES Todos Chasis Motorhome c/ Suspensión Delantero Independiente	
F	75-84	VAN 1 TON, P SERIES Todos Chasis Motorhome	
F	74	VAN 1 TON, P SERIES Motor Home	
<b>G63396</b>	D		140780
F	78-79	<b>FORD</b> BRONCO Todos Suspensión Quad; detrás del Eje Delantero; Exc. Kit de Levantamiento	
F	78-79	PICKUP 1/2 TON, F-150 4x4 Detrás del Eje Delantero	
F	77	PICKUP 1/2 TON, F-150 4x4	
F	75-79	PICKUP 1 TON, F-350 / SUPERDUTY Extended Cab Pickup, 4x2 Tracción trasera	
<b>G63398</b>	W		141138
F	78-79	<b>FORD</b> PICKUP 1/2 TON, F-150 Extended Cab Pickup, 4x4 Exc. Kit de Levantamiento	
F	79	PICKUP 1 TON, F-350 / SUPERDUTY 4x4	
F	77-79	PICKUP 3/4 TON, F-250 / SUPERDUTY Cab & Chassis, 4x4 Aplica para toda la serie No. Y20001	
F	77-79	PICKUP 3/4 TON, F-250 / SUPERDUTY Standard Cab Pickup, 4x4 Aplica para toda la serie No. Y20001	
<b>G63403</b>	C		
R	79-91	<b>CHEVROLET</b> VAN 1 TON, G / EXPRESS Todos PBV 9200	
R	79-96	<b>GMC</b> VAN 1 TON, G / SAVANNA Cutaway Van PBV 9200	
F	85	VAN 1 TON, P SERIES Todos Chasis Motorhome c/ Eje de Viga Delantero en I	
<b>G63404</b>	D		141349
F	84-85	<b>TOYOTA</b> 4RUNNER Todos	
F	80-85	PICKUP 4x4 Exc. Kit de Levantamiento	
<b>G63405</b>	W		140884
R	65	<b>FORD</b> F-100	
R	65-66	F-350 PICKUP	
R	55	F SERIES Todos F-100	
F	48-52	F SERIES Todos F-1, F-2 & F-3	
R	61-64	PICKUP 1/2 TON, F-100 Todos	
R	61-66	PICKUP 1 TON, F-350 / SUPERDUTY Todos	
R	61-64	PICKUP 3/4 TON, F-250 / SUPERDUTY Todos	
F	68-76	PICKUP P350 Todos Hasta PBV 8000#	
F	75-76	PICKUP P400 Todos Hasta PBV 8000#	
R	68	<b>INTERNATIONAL</b> 908B Todos	
R	68	908C Todos	
R	68	1000B Todos Exc. Travelette c/ base de rueda de 166"	
R	68	1000C Todos Exc. Travelette c/ base de rueda de 166"	
F	68	1100B Todos Exc. Travelette c/ base de rueda de 166"	

Lista numérica

Amort.	POP	No. Alternativo	Montaje Accesorio
Pos.	Año	Aplicación	
<b>G63405</b>	W	-continued	<b>140884</b>
R 68	1100B	Todos Exc. Travelette c/ base de rueda de 166"	
F 68	1100C	Todos Exc. Travelette c/ base de rueda de 166"	
R 68	1100C	Todos Exc. Travelette c/ base de rueda de 166"	
F 68	1200B	Todos Exc. Travelette c/ base de rueda de 166"	
R 68	1200B	Todos Exc. Travelette c/ base de rueda de 166"	
F 68	1200C	Todos Exc. Travelette c/ base de rueda de 166"	
R 68	1200C	Todos Exc. Travelette c/ base de rueda de 166"	
F 68	1300B	Todos Exc. Travelette c/ base de rueda de 166"	
R 68	1300B	Todos Exc. Travelette c/ base de rueda de 166"	
F 68	1300C	Todos Exc. Travelette c/ base de rueda de 166"	
R 68	1300C	Todos Exc. Travelette c/ base de rueda de 166"	
R 68-72	M1100 / M1200	Todos	
R 69	M1400	Todos	
R 65-67	M SERIES	VAN Todos	
R 65	JEEP CJ3	Todos Exc. Kit de Levantamiento	
R 65-83	CJ5	Todos Exc. Kit de Levantamiento	
R 65-75	CJ6	Todos Exc. Kit de Levantamiento	
R 76-86	CJ7	Todos Exc. Kit de Levantamiento	
R 66-74	DJ5	Todos Exc. Kit de Levantamiento	
R 66-68	DJ6	Todos Exc. Kit de Levantamiento	
R 57-60	FC150	Todos	
F 63-65	FC170	Todos	
R 63-65	FC170	Todos	
R 63-66	GLADIATOR	Todos Suspensión Delantera Independiente	
R 70-73	JEEPSTER	Todos	
R 81-85	SCRAMBLER / CJ8	Todos	
R 65-67	UNIVERSAL	Todos Exc. Kit de Levantamiento	
R 61-64	UNIVERSAL	Todos	
<b>G63406</b>	B		
R 85-96	FORD PICKUP	1/2 TON, F-150 4x2 Tracción trasera	
R 80-97	PICKUP	1 TON, F-350 / SUPERDUTY 4x2 Tracción trasera Exc. Doble Rodada Trasera	
R 97	PICKUP	3/4 TON, F-250 / SUPERDUTY 4x2 Tracción trasera PBV arriba de 8500#	
R 80-96	PICKUP	3/4 TON, F-250 / SUPERDUTY 4x2 Tracción trasera	
<b>G63409</b>	B		
R 82-85	FORD	B150	
R 80-96	BRONCO	Todos Exc. Kit de Levantamiento	
R 86-90	F-200		
R 80-83	PICKUP	1/2 TON, F-100 4x2 Tracción trasera	
R 80-84	PICKUP	1/2 TON, F-150 4x2 Tracción trasera	
R 90-97	PICKUP	1/2 TON, F SUPERDUTY Todos	
R 80-97	PICKUP	1 TON, F-350 / SUPERDUTY 4x2 Tracción trasera Doble Rodada Trasera	
R 97	PICKUP	F-450 SUPERDUTY Todos	
<b>G63410</b>	C		<b>141047</b>
F 80-96	FORD BRONCO	Todos Suspensión Quad adelante del Eje Delantero; Exc. Kit de Levantamiento	
F 83-85	F-350	PICKUP	
F 80-96	PICKUP	1/2 TON, F-150 4x4 Suspensión Quad adelante del Eje Delantero; Exc. Kit de Levantamiento	
F 80-81	PICKUP	1 TON, F-350 / SUPERDUTY 4x4	
F 80-82	PICKUP	3/4 TON, F-250 / SUPERDUTY Standard Cab Pickup, 4x4	
<b>G63411</b>	W		
F 77-86	CHEVROLET	PICKUP 1 TON, K30 Todos	
F 90-91	PICKUP	1 TON, R3500 Todos	

Amortiguadores para Camioneta Ultra

Amort.	POP	No. Alternativo	Montaje Accesorio
Pos.	Año	Aplicación	
<b>G63411</b>	W	-continued	
F 89	PICKUP	1 TON, R3500 Cab & Chassis	
F 89	PICKUP	1 TON, R3500 Crew Cab Pickup	
F 87-88	PICKUP	1 TON, V30 Todos	
F 89-91	PICKUP	1 TON, V3000 / V3500 Todos	
F 77-86	GMC	PICKUP 1 TON, K35 / K3500 Todos	
F 87-91	PICKUP	1 TON, V3000 / V3500 Todos	
<b>G63413</b>	C		
R 78-95	CHEVROLET	VAN 1/2 TON, G / EXPRESS Todos	
R 85-95	VAN	1 TON, G / EXPRESS Extended Cargo Van	
R 85-95	VAN	1 TON, G / EXPRESS Extended Passenger Van	
R 78-95	VAN	1 TON, G / EXPRESS Standard Cargo Van	
R 78-95	VAN	1 TON, G / EXPRESS Standard Passenger Van	
R 78	VAN	1 TON, G / EXPRESS Extended Cargo Van	
R 78-95	VAN	3/4 TON, G / EXPRESS Todos Exc. PBV 8600 #	
R 99-03	DODGE	VAN 1/2 TON, A / B SERIES / RAM 109.3 (WheelBase) Exc. PBV 7000#	
R 81-98	VAN	1/2 TON, A / B SERIES / RAM 109.6 (WheelBase) Exc. PBV 7000#	
R 71-80	VAN	1/2 TON, A / B SERIES / RAM Todos	
R 99-03	VAN	1 TON, A / B SERIES / RAM Todos	
R 94-98	VAN	1 TON, A / B SERIES / RAM Todos Exc. Eje Delantero 4000#	
R 71-93	VAN	1 TON, A / B SERIES / RAM Todos	
R 71-03	VAN	3/4 TON, A / B SERIES / RAM Todos	
R 74-80	VAN	CB300 Todos	
R 78-95	GMC	VAN 1/2 TON, G / SAVANNA Todos	
R 85-96	VAN	1 TON, G / SAVANNA Extended Cargo Van	
R 85-96	VAN	1 TON, G / SAVANNA Extended Passenger Van	
R 79-96	VAN	1 TON, G / SAVANNA Standard Cargo Van	
R 79-96	VAN	1 TON, G / SAVANNA Standard Passenger Van	
R 78	VAN	1 TON, G / SAVANNA Cutaway Van	
R 78-95	VAN	3/4 TON, G / SAVANNA Todos Exc. PBV 8600 #	
R 74-83	PLYMOUTH	VAN 1/2 TON, PB SERIES Todos	
R 74-83	VAN	1 TON, PB SERIES Todos	
R 74-83	VAN	3/4 TON, PB SERIES Todos	
<b>G63414</b>	A		<b>140780</b>
F 82-85	FORD	B150	
F 92	B200		
F 97	BRONCO		
F 80-96	BRONCO	Todos Con o sin Suspensión Quad detrás del Eje Delantero; Exc. Kit de Levantamiento	
F 89	BRONCO	II Todos Fab. hasta 2/89; Vehículos con perno 10mm & 12mm en montaje inferior trasero	
F 84-88	BRONCO	II Todos Con Perno de 10mm en Montaje Inferior Trasero	
F 86-90	F-200		
F 99-00	F-350	PICKUP	
F 80-83	PICKUP	1/2 TON, F-100 4x2 Tracción trasera	
F 80-96	PICKUP	1/2 TON, F-150 4x4 Con o sin Suspensión Quad detrás del Eje Delantero; Exc. Kit de Levantamiento	
F 80-96	PICKUP	1/2 TON, F-150 4x2 Tracción trasera	
F 80-97	PICKUP	1 TON, F-350 / SUPERDUTY 4x2 Tracción trasera	
F 97	PICKUP	3/4 TON, F-250 / SUPERDUTY 4x2 Tracción trasera PBV arriba de 8500#	
F 80-96	PICKUP	3/4 TON, F-250 / SUPERDUTY 4x2 Tracción trasera	
F 87-89	RANGER	Todos Exc. Opción High Ryder	

Lista numérica

Amort.	POP	No. Alternativo	Montaje Accesorio
Pos.	Año	Aplicación	
<b>G63414</b>	A	-continued	<b>140780</b>
F 83-86	RANGER	Todos	
<b>G63416</b>	W		<b>140780</b>
F 86	FORD	F-200	
F 82-85	PICKUP	1 TON, F-350 / SUPERDUTY 4x4 Montaje Inferior Delantero Tipo Abrazadera Exc. Doble Rodado o Kit de Levantamiento	
F 83-86	PICKUP	3/4 TON, F-250 / SUPERDUTY 4x4 Montaje Inferior Delantero Tipo Abrazadera Exc. Doble Rodado o Kit de Levantamiento	
F 80-82	PICKUP	3/4 TON, F-250 / SUPERDUTY Extended Cab Pickup, 4x4	
<b>G63418</b>	D		<b>141356</b>
F 87-89	DODGE	RAIDER Todos	
<b>G63419</b>	W		
R 87-93	DODGE	PICKUP, RAM 50 4x4	
<b>G63420</b>	D		
R 83-88	FORD	RANGER 4x4	
<b>G63421</b>	A		<b>140455</b>
F 05	CHEVROLET	BLAZER Base, 4x2 Tracción trasera	
F 96-04	BLAZER	LS, 4x2 Tracción trasera	
F 95-02	BLAZER	LT, 4x2 Tracción trasera	
F 95-99	BLAZER	Base, 4x2 Tracción trasera	
F 95-97	BLAZER	Deluxe, 4x2 Tracción trasera	
F 83-94	BLAZER	S MODELS 4x2 Tracción trasera	
F 94-03	S10	LS, 4x2 Tracción trasera	
F 82-03	S10	Base, 4x2 Tracción trasera	
F 99	S10	Xtreme, 4x2 Tracción trasera	
F 92-93	S10	EL, 4x2 Tracción trasera	
F 83-92	S10	Tahoe, 4x2 Tracción trasera	
F 88-90	S10	Durango, 4x2 Tracción trasera	
F 82-86	S10	Durango, 4x2 Tracción trasera	
F 92-04	GMC	JIMMY 4x2 Tracción trasera	
F 83-91	S15	JIMMY 4x2 Tracción trasera	
F 04	SONOMA / S15	Todos 4x2 Tracción trasera	
F 82-03	SONOMA / S15	4x2 Tracción trasera	
F 72-76	MAZDA	B1600 Todos	
F 77-78	B1800	Todos	
F 79-84	B2000	Todos	
F 82-84	B2200	Todos	
<b>G63422</b>	B		
R 05	CHEVROLET	BLAZER Base, 4x4	
R 05	BLAZER	Base, 4x2 Tracción trasera	
R 96-04	BLAZER	LS, 4x4	
R 96-04	BLAZER	LS, 4x2 Tracción trasera	
R 95-02	BLAZER	LT, 4x2 Tracción trasera	
R 95-01	BLAZER	LT, 4x4	
R 95-99	BLAZER	Base, 4x4	
R 95-99	BLAZER	Base, 4x2 Tracción trasera	
R 95-97	BLAZER	Deluxe, 4x2 Tracción trasera	
R 83-94	BLAZER	S MODELS Todos	
R 99-04	S10	LS, 4x4	
R 99-03	S10	Base, 4x4	
R 99-03	S10	Base, 4x2 Tracción trasera	
R 99-03	S10	LS, 4x2 Tracción trasera	
R 94-98	S10	LS	
R 82-98	S10	Base	
R 92-93	S10	EL	
R 83-92	S10	Tahoe	
R 88-90	S10	Durango	
R 82-86	S10	Durango	
R 92-05	GMC	JIMMY Todos	
R 83-91	S15	JIMMY Todos	
R 82-04	SONOMA / S15	Todos	
R 91	SYCLONE	Todos	
R 92-93	TYPHOON	Todos	
<b>G63423</b>	B		
F 05	CHEVROLET	BLAZER Base, 4x4	
F 96-04	BLAZER	LS, 4x4	
F 95-01	BLAZER	LT, 4x4	
F 95-99	BLAZER	Base, 4x4	
F 83-94	BLAZER	S MODELS 4x4	
F 94-04	S10	LS, 4x4	
F 83-03	S10	Base, 4x4	
F 92-93	S10	EL, 4x4	
F 83-92	S10	Tahoe, 4x4	
F 88-90	S10	Durango, 4x4	
F 83-86	S10	Durango, 4x4	
F 92-05	GMC	JIMMY 4x4	

Lista numérica

Amort.	POP	No. Alternativo	Montaje Accesorio
Pos.	Año	Aplicación	
<b>G63423</b>	B	-continued	
F	83-91	S15 JIMMY 4x4	
F	83-04	SONOMA / S15 4x4	
F	91	SYCLONE Todos	
F	92-93	TYPHOON Todos	
<b>G63424</b>	A	141353,142592	
F	84-01	JEEP CHEROKEE Todos	
F	86-92	COMANCHE Todos	
F	92	GRAND CHEROKEE	
F	93-98	GRAND CHEROKEE Todos	
F	84-90	WAGONEER Todos	
<b>G63425</b>	B		
R	84-01	JEEP CHEROKEE Todos	
R	84-90	WAGONEER Todos	
<b>G63427</b>	C		
R	89	FORD BRONCO II Todos Fab. hasta 2/89; Vehículos con perno 10mm & 12mm en montaje inferior trasero	
R	84-88	BRONCO II Todos Con Perno de 10mm en Montaje Inferior Trasero	
R	89	RANGER 4x2 Tracción trasera Fab. hasta 2/89; Vehículos con perno 10mm & 12mm en montaje inferior trasero	
R	83-88	RANGER 4x2 Tracción trasera	
<b>G63437</b>	W		
F	87-91	CHEVROLET BLAZER 4x4 Automóvil Grande; Kit de Levantamiento de 4"; Exc. Suspensión Quad	
F	73-86	BLAZER 4x4 Con Kit de Levantamiento de 4"; Exc. Suspensión Quad	
F	73-86	PICKUP 1/2 TON, K10 Todos Con Kit de Levantamiento de 4"; Exc. Suspensión Quad	
F	87	PICKUP 1/2 TON, V10 Todos Con Kit de Levantamiento de 4"; Exc. Suspensión Quad	
F	73-86	PICKUP 3/4 TON, K20 Todos Con Kit de Levantamiento de 4"; Exc. Suspensión Quad	
F	87	PICKUP 3/4 TON, V20 Todos Con Kit de Levantamiento de 4"; Exc. Suspensión Quad	
F	73-86	SUBURBAN 1/2 TON, K10 Todos Con Kit de Levantamiento de 4"; Exc. Suspensión Quad	
F	89-91	SUBURBAN 1/2 TON, V1500 4x4 Con Kit de Levantamiento de 4"; Exc. Suspensión Quad	
F	73-86	SUBURBAN 3/4 TON, K20 Todos Con Kit de Levantamiento de 4"; Exc. Suspensión Quad	
F	87-88	SUBURBAN 3/4 TON, V20 Todos Con Kit de Levantamiento de 4"; Exc. Suspensión Quad	
F	89-91	SUBURBAN 3/4 TON, V2500 Todos Con Kit de Levantamiento de 4"; Exc. Suspensión Quad	
F	75-91	GMC JIMMY 4x4 Con Kit de Levantamiento de 4"; Exc. Suspensión Quad	
F	73-74	JIMMY Todos Con Kit de Levantamiento de 4"; Exc. Suspensión Quad	
F	73-86	PICKUP 1/2 TON, K15 / K1500 Todos Con Kit de Levantamiento de 4"; Exc. Suspensión Quad	
F	87	PICKUP 1/2 TON, V1500 Todos Con Kit de Levantamiento de 4"; Exc. Suspensión Quad	
F	73-86	PICKUP 3/4 TON, K25 / K2500 Todos Con Kit de Levantamiento de 4"; Exc. Suspensión Quad	
F	87	PICKUP 3/4 TON, V2500 Todos Con Kit de Levantamiento de 4"; Exc. Suspensión Quad	
F	73-86	SUBURBAN 1/2 TON, K15 / K1500 Todos Con Kit de Levantamiento de 4"; Exc. Suspensión Quad	
F	87-91	SUBURBAN 1/2 TON, V1500 Todos Con Kit de Levantamiento de 4"; Exc. Suspensión Quad	
F	73-86	SUBURBAN 3/4 TON, K25 / K2500 Todos Con Kit de Levantamiento de 4"; Exc. Suspensión Quad	
F	87-91	SUBURBAN 3/4 TON, V2500 Todos Con Kit de Levantamiento de 4"; Exc. Suspensión Quad	

Amortiguadores para Camioneta Ultra

Amort.	POP	No. Alternativo	Montaje Accesorio
Pos.	Año	Aplicación	
<b>G63438</b>	W	140357	
R	87-90	CHEVROLET BLAZER 4x4 Automóvil Grande; Kit de Levantamiento de 4"; Exc. Suspensión Quad	
R	73-86	BLAZER 4x4 Con Kit de Levantamiento de 4"; Exc. Suspensión Quad	
R	73-86	PICKUP 1/2 TON, K10 Todos Con Kit de Levantamiento de 4"; Exc. Suspensión Quad	
R	87	PICKUP 1/2 TON, V10 Todos Con Kit de Levantamiento de 4"; Exc. Suspensión Quad	
R	73-86	PICKUP 3/4 TON, K20 Todos Con Kit de Levantamiento de 4"; Exc. Suspensión Quad	
R	87	PICKUP 3/4 TON, V20 Todos Con Kit de Levantamiento de 4"; Exc. Suspensión Quad	
R	73-86	SUBURBAN 1/2 TON, K10 Todos Con Kit de Levantamiento de 4"; Exc. Suspensión Quad	
R	73-86	SUBURBAN 3/4 TON, K20 Todos Con Kit de Levantamiento de 4"; Exc. Suspensión Quad	
R	87-88	SUBURBAN 3/4 TON, V20 Todos Con Kit de Levantamiento de 4"; Exc. Suspensión Quad	
R	89-91	SUBURBAN 3/4 TON, V2500 Todos Con Kit de Levantamiento de 4"; Exc. Suspensión Quad	
R	73-91	GMC JIMMY Todos Con Kit de Levantamiento de 4"; Exc. Suspensión Quad	
R	73-86	PICKUP 1/2 TON, K15 / K1500 Todos Con Kit de Levantamiento de 4"; Exc. Suspensión Quad	
R	87	PICKUP 1/2 TON, V1500 Todos Con Kit de Levantamiento de 4"; Exc. Suspensión Quad	
R	73-86	PICKUP 3/4 TON, K25 / K2500 Todos Con Kit de Levantamiento de 4"; Exc. Suspensión Quad	
R	87	PICKUP 3/4 TON, V2500 Todos Con Kit de Levantamiento de 4"; Exc. Suspensión Quad	
R	73-86	SUBURBAN 1/2 TON, K15 / K1500 Todos Con Kit de Levantamiento de 4"; Exc. Suspensión Quad	
R	87-91	SUBURBAN 1/2 TON, V1500 Todos Con Kit de Levantamiento de 4"; Exc. Suspensión Quad	
R	73-86	SUBURBAN 3/4 TON, K25 / K2500 Todos Con Kit de Levantamiento de 4"; Exc. Suspensión Quad	
R	87-91	SUBURBAN 3/4 TON, V2500 Todos Con Kit de Levantamiento de 4"; Exc. Suspensión Quad	
<b>G63439</b>	W		
R	80-86	FORD PICKUP 1/2 TON, F-150 Todos Kit de Levantamiento de 3-4"	
<b>G63440</b>	W		
R	65	JEEP CJ3 Todos Kit de Levantamiento de 2-4"	
R	82-83	CJ5 Todos Kit de Levantamiento de 3-4"	
R	65-81	CJ5 Todos Kit de Levantamiento de 2-4"	
R	65-75	CJ6 Todos Kit de Levantamiento de 2-4"	
R	82-86	CJ7 Todos Kit de Levantamiento de 3-4"	
R	76-81	CJ7 Todos Kit de Levantamiento de 2-4"	
R	66-74	DJ5 Todos Kit de Levantamiento de 2-4"	
R	66-68	DJ6 Todos Kit de Levantamiento de 2-4"	
R	65-67	UNIVERSAL Todos Kit de Levantamiento de 2-4"	
R	80-83	TOYOTA PICKUP 4x4 Kit de Levantamiento de 2-3"	
<b>G63441</b>	W		
R	80-88	FORD BRONCO Todos Kit de Levantamiento de 3-4"	
R	78-79	BRONCO Todos Kit de Levantamiento de 3 1/2-4" Exc. Suspensión Quad	
R	66-77	BRONCO Todos Kit de Levantamiento de 4-5"	

Lista numérica

Amort.	POP	No. Alternativo	Montaje Accesorio
Pos.	Año	Aplicación	
<b>G63441</b>	W	-continued	
F	82-83	JEEP CJ5 Todos Kit de Levantamiento de 2-4"	
F	82-86	CJ7 Todos Kit de Levantamiento de 2-4"	
<b>G63443</b>	W		
R	82-83	JEEP CJ5 Todos Kit de Levantamiento de 2"	
F	66-81	CJ5 Todos Kit de Levantamiento de 2-4"	
F	66-75	CJ6 Todos Kit de Levantamiento de 2-4"	
R	82-86	CJ7 Todos Kit de Levantamiento de 2"	
F	76-81	CJ7 Todos Kit de Levantamiento de 2-4"	
F	66-74	DJ5 Todos Kit de Levantamiento de 2-4"	
F	66-68	DJ6 Todos Kit de Levantamiento de 2-4"	
F	65-67	UNIVERSAL Todos Kit de Levantamiento de 2-4"	
<b>G63444</b>	W	141041	
F	80-83	TOYOTA PICKUP 4x4 Kit de Levantamiento de 2-3"	
<b>G63445</b>	W	140780	
F	80-86	FORD BRONCO Todos Kit de Levantamiento de 3-4", Suspensión Quad detrás del Eje Delantero	
F	78-79	BRONCO Todos Derecho Kit de Levantamiento de 3 1/2-4" Exc. Suspensión Quad	
F	66-77	BRONCO Todos Kit de Levantamiento de 4-5"	
F	77-79	PICKUP 1/2 TON, F-100 Todos Kit de Levantamiento de 3-4" Exc. Suspensión Quad	
F	80-86	PICKUP 1/2 TON, F-150 Todos Kit de Levantamiento de 3-4"	
F	77-79	PICKUP 1/2 TON, F-150 Cab & Chassis, 4x4 Kit de Levantamiento de 3-4" Exc. Suspensión Quad	
F	77-79	PICKUP 1/2 TON, F-150 Standard Cab Pickup, 4x4 Kit de Levantamiento de 3-4" Exc. Suspensión Quad	
<b>G63446</b>	W	141047	
F	80-86	FORD BRONCO Todos Kit de Levantamiento de 3-4", Suspensión Quad adelante del Eje Delantero	
F	80-86	PICKUP 1/2 TON, F-150 4x4 Suspensión Quad c/ Kit de Levantamiento de 3-4" adelante del Eje Delantero	
<b>G63447</b>	W	140780	
F	78-79	FORD BRONCO Todos Izquierdo Kit de Levantamiento de 3 1/2-4" Exc. Suspensión Quad	
R	77-79	PICKUP 1/2 TON, F-100 Todos 4x4 Kit de Levantamiento de 3-4" Exc. Suspensión Quad	
R	75-76	PICKUP 1/2 TON, F-100 4x4 Kit de Levantamiento de 3 1/2-4"	
R	73-74	PICKUP 1/2 TON, F-100 4x4 Kit de Levantamiento	
R	70-72	PICKUP 1/2 TON, F-100 Todos 4x4; Kit de Levantamiento	
R	77-79	PICKUP 1/2 TON, F-150 Cab & Chassis, 4x4 Kit de Levantamiento de 3-4" Exc. Suspensión Quad	
R	77-79	PICKUP 1/2 TON, F-150 Standard Cab Pickup, 4x4 Kit de Levantamiento de 3-4" Exc. Suspensión Quad	
R	76	PICKUP 1/2 TON, F-150 Cab & Chassis, 4x4 Kit de Levantamiento	
R	76	PICKUP 1/2 TON, F-150 Standard Cab Pickup, 4x4 Kit de Levantamiento	
R	75	PICKUP 1/2 TON, F-150 Cab & Chassis 4x4; Kit de Levantamiento	
R	75	PICKUP 1/2 TON, F-150 Standard Cab Pickup 4x4; Kit de Levantamiento	
<b>G63454</b>	B		
R	90-05	CHEVROLET ASTRO Todos	
R	85-89	ASTRO 4x2 Tracción trasera	
R	90-05	GMC SAFARI Todos	
R	85-89	SAFARI 4x2 Tracción trasera	
R	86-89	VOLKSWAGEN VANAGON 4x4	

## Lista numérica

Amort.	POP	No. Alternativo	Montaje Accesorio
Pos.	Año	Aplicación	
<b>G63455</b> B			
F	87-90	<b>FORD</b> F-200	
F	94-97	F-350 PICKUP	
F	86-92	F-350 PICKUP	
F	65-78	F-350 PICKUP	
F	86-97	PICKUP 1 TON, F-350 / SUPERDUTY 4x4	
F	97-98	PICKUP 3/4 TON, F-250 / SUPERDUTY 4x4 PBV arriba de 8500#	
F	87-96	PICKUP 3/4 TON, F-250 / SUPERDUTY 4x4	
<b>G63456</b> W			
R	94-97	<b>FORD</b> F-350 PICKUP	
R	86-92	F-350 PICKUP	
R	86-97	PICKUP 1 TON, F-350 / SUPERDUTY 4x4 Exc. Doble Rodada Trasera	
<b>G63457</b> C 140126			
F	86-97	<b>FORD</b> AEROSTAR 4x2 Tracción trasera	
<b>G63461</b> C			
R	80-96	<b>FORD</b> PICKUP 1/2 TON, F-150 4x4 Exc. Kit de Levantamiento	
R	86-97	PICKUP 1 TON, F-350 / SUPERDUTY 4x4 Doble Rodada Trasera	
R	82-85	PICKUP 1 TON, F-350 / SUPERDUTY 4x4 Montaje Inferior Delantero Tipo Abrazadera Exc. Doble Rodado o Kit de Levantamiento	
R	80-81	PICKUP 1 TON, F-350 / SUPERDUTY 4x4 Doble Rodada Trasera	
R	97	PICKUP 3/4 TON, F-250 / SUPERDUTY 4x4 PBV arriba de 8500#	
R	86-96	PICKUP 3/4 TON, F-250 / SUPERDUTY 4x4	
R	82-85	PICKUP 3/4 TON, F-250 / SUPERDUTY 4x4 Montaje Inferior Delantero Tipo Abrazadera Exc. Doble Rodado o Kit de Levantamiento	
R	80-81	PICKUP 3/4 TON, F-250 / SUPERDUTY 4x4	
<b>G63479</b> B 140524			
F	86-89	<b>TOYOTA</b> 4RUNNER Todos	
F	86-95	PICKUP 4x4 Exc. Kit de Levantamiento	
F	93-98	T100 4x4	
<b>G63484</b> W 140524			
R	84-89	<b>TOYOTA</b> VAN Coil (RearSpringType)	
R	88	VAN WAGON Coil (FrontSpringType), Coil (RearSpringType)	
<b>G63488</b> A			
R	88-99	<b>CHEVROLET</b> PICKUP 1/2 TON, C15 / C1500 Todos	
R	88-99	PICKUP 1/2 TON, K15 / K1500 Todos	
R	01-03	PICKUP 1 TON, C35/3500 Base Eje Delantero Rígido HD	
R	92-00	PICKUP 1 TON, C35/3500 Crew Cab Pickup Eje Delantero Rígido HD	
R	88-00	PICKUP 1 TON, C35/3500 Extended Cab Pickup Eje Delantero Rígido HD	
R	88-90	PICKUP 1 TON, C35/3500 Standard Cab Pickup Eje Delantero Rígido HD	
R	88-00	PICKUP 1 TON, K35 / K3500 Todos	
R	88-00	PICKUP 3/4 TON, C25 / C2500 Todos	
R	88-00	PICKUP 3/4 TON, K25 / K2500 Todos	
R	01-02	<b>GMC</b> C3500	
R	88-99	PICKUP 1/2 TON, C15 / C1500 Todos	
R	88-99	PICKUP 1/2 TON, K15 / K1500 Todos	
R	92-00	PICKUP 1 TON, C35/3500 Crew Cab Pickup Eje Delantero Rígido HD	
R	88-00	PICKUP 1 TON, C35/3500 Extended Cab Pickup Eje Delantero Rígido HD	
R	88-00	PICKUP 1 TON, C35/3500 Standard Cab Pickup Eje Delantero Rígido HD	
R	88-00	PICKUP 1 TON, K35 / K3500 Todos	
R	88-00	PICKUP 3/4 TON, C25 / C2500 Todos	

## Amortiguadores para Camioneta Ultra

Amort.	POP	No. Alternativo	Montaje Accesorio
Pos.	Año	Aplicación	
<b>G63488</b> A -continued			
R	88-00	PICKUP 3/4 TON, K25 / K2500 Todos	
<b>G63489</b> A 141277			
F	88-99	<b>CHEVROLET</b> PICKUP 1/2 TON, C15 / C1500 Todos	
F	92-00	PICKUP 1 TON, C35/3500 Crew Cab Pickup Eje Delantero Rígido HD	
F	88-00	PICKUP 1 TON, C35/3500 Extended Cab Pickup Eje Delantero Rígido HD	
F	88-00	PICKUP 1 TON, C35/3500 Standard Cab Pickup Eje Delantero Rígido HD	
F	88-00	PICKUP 3/4 TON, C25 / C2500 Todos	
F	92-99	SUBURBAN 1/2 TON, C15 / C1500 Todos	
F	92-99	SUBURBAN 3/4 TON, C25 / C2500 Todos	
F	95-00	TAHOE 4x2 Tracción trasera Old Body Style	
F	88-99	<b>GMC</b> PICKUP 1/2 TON, C15 / C1500 Todos	
F	92-00	PICKUP 1 TON, C35/3500 Crew Cab Pickup Eje Delantero Rígido HD	
F	88-00	PICKUP 1 TON, C35/3500 Extended Cab Pickup Eje Delantero Rígido HD	
F	88-00	PICKUP 1 TON, C35/3500 Standard Cab Pickup Eje Delantero Rígido HD	
F	88-00	PICKUP 3/4 TON, C25 / C2500 Todos	
F	92-99	SUBURBAN 1/2 TON, C15 / C1500 Todos	
F	92-99	SUBURBAN 3/4 TON, C25 / C2500 Todos	
F	92-99	YUKON 4x2 Tracción trasera	
<b>G63490</b> C			
R	86-88	<b>FORD</b> AEROSTAR 4x2 Tracción trasera	
R	87-95	<b>JEEP</b> WRANGLER YJ (Código plataforma del fabricante)	
<b>G63491</b> B 140524			
R	65-83	<b>NISSAN</b> PICKUP	
<b>G63492</b> B 141137			
R	87-89	<b>DODGE</b> RAIDER 2.6L 4Cyl L (156) Exc. Sport Utility	
F	61-67	<b>FORD</b> ECONOLINE Todos	
F	68	VAN 1/2 TON, ECONOLINE / CLUB WAGON Todos Fabricado antes de Jul/68	
R	81-95	<b>ISUZU</b> PICKUP 4x2 Tracción trasera	
R	86-92	<b>JEEP</b> COMANCHE Todos	
F	66-73	WAGONEER Todos	
F	63-65	WAGONEER Todos Exc. Suspensión Independiente Delantera	
R	00-04	<b>NISSAN</b> FRONTIER Crew Cab Pickup, 4x2 Tracción trasera con Desert Runner	
R	98-04	FRONTIER 4x4	
R	98-99	FRONTIER 4x2 Tracción trasera Crew Cab con Desert Runner	
R	95-97	PICKUP 4x4	
R	65-93	PICKUP	
R	85-92	<b>TOYOTA</b> PICKUP 4x2 Tracción trasera 1 Ton	
R	80-83	PICKUP 4x4 Exc. Kit de Levantamiento	
<b>G63494</b> A 140149			
R	84-89	<b>TOYOTA</b> 4RUNNER Todos	
R	84-95	PICKUP 4x4 Exc. Kit de Levantamiento	
R	98-04	TACOMA Pre Runner Exc. Upgrade HD	
R	95-04	TACOMA 4x4 Exc. Upgrade HD	
<b>G63495</b> C 141350			
F	86-87	<b>MAZDA</b> B2000 4x2 Tracción trasera	
F	87-93	B2200 4x2 Tracción trasera	
F	87-93	B2600 4x2 Tracción trasera	
<b>G63500</b> D 140780			
F	79-81	<b>FORD</b> B100	
F	73-74	B100	
F	75-78	B150	
F	75-91	VAN 1/2 TON, ECONOLINE / CLUB WAGON Todos	
<b>G63502</b> C			
R	90-97	<b>FORD</b> AEROSTAR Todos	
R	89	AEROSTAR 4x2 Tracción trasera	

## Lista numérica

Amort.	POP	No. Alternativo	Montaje Accesorio
Pos.	Año	Aplicación	
<b>G63511</b> D 141353			
F	78-79	<b>FORD</b> BRONCO Todos Suspensión Quad Amortiguador Largo; Exc. Kit de Levantamiento	
F	78-79	PICKUP 1/2 TON, F-150 Custom, 4x4 Suspensión Quad Amortiguador Largo; Exc. Kit de Levantamiento	
F	78-79	PICKUP 1/2 TON, F-150 Ranger Lariat, 4x4 Suspensión Quad Amortiguador Largo; Exc. Kit de Levantamiento	
F	78-79	PICKUP 1/2 TON, F-150 Ranger, 4x4 Suspensión Quad Amortiguador Largo; Exc. Kit de Levantamiento	
F	78	PICKUP 1/2 TON, F-150 Base, 4x4 Suspensión Quad Amortiguador Largo; Exc. Kit de Levantamiento	
F	78	PICKUP 1/2 TON, F-150 Northland, 4x4 Suspensión Quad Amortiguador Largo; Exc. Kit de Levantamiento	
F	87-95	<b>JEEP</b> WRANGLER YJ (Código plataforma del fabricante)	
<b>G63524</b> B			
R	89-97	<b>FORD</b> RANGER 4x4	
R	95-96	<b>MAZDA</b> B2300 4x4	
R	94-97	B3000 4x4	
R	94-97	B4000 4x4	
<b>G63525</b> A			
R	90	<b>FORD</b> BRONCO II Todos	
R	89	BRONCO II Todos Fab. desde 2/89; Vehículos con perno de 12mm en montaje inferior trasero	
R	90-97	RANGER 4x2 Tracción trasera	
R	89	RANGER 4x2 Tracción trasera Fab. desde 2/89; Vehículos con perno de 12mm en montaje inferior trasero	
R	94-97	<b>MAZDA</b> B2300 4x2 Tracción trasera	
R	94-97	B3000 4x2 Tracción trasera	
R	94-97	B4000 4x2 Tracción trasera	
<b>G63547</b> C 141350			
F	90-95	<b>TOYOTA</b> 4RUNNER Todos	
<b>G63548</b> C 140921			
R	90-95	<b>TOYOTA</b> 4RUNNER Todos	
<b>G63603</b> D 140780			
F	87-89	<b>FORD</b> RANGER 4x4 Opción High Ryder	
<b>G63604</b> W			
R	89	<b>DODGE</b> RAIDER Sport Utility, 3.0L 6Cyl V (181)	
<b>G63605</b> W 140169			
F	74	<b>DODGE</b> M300 Todos	
F	74	M350 Todos	
<b>G63607</b> B 140719			
R	00-05	<b>FORD</b> EXCURSION 4x2 Tracción trasera	
R	91-94	EXPLORER Todos	
<b>G63608</b> B 140780			
F	91-94	<b>FORD</b> EXPLORER Todos	
<b>G63609</b> C			
F	99-00	<b>CADILLAC</b> ESCALADE Todos	
F	92-94	<b>CHEVROLET</b> BLAZER 4x4 Automóvil Grande	
F	88-00	PICKUP 1 TON, K35 / K3500 Todos	
F	88-00	PICKUP 3/4 TON, K25 / K2500 Todos	
F	92-99	SUBURBAN 1/2 TON, K15 / K1500 Todos	
F	92-99	SUBURBAN 3/4 TON, K25 / K2500 Todos	
F	95-00	TAHOE 4x4 Old Body Style	
F	88-00	<b>GMC</b> PICKUP 1 TON, K35 / K3500 Todos	
F	88-00	PICKUP 3/4 TON, K25 / K2500 Todos	
F	92-99	SUBURBAN 1/2 TON, K15 / K1500 Todos	
F	92-99	SUBURBAN 3/4 TON, K25 / K2500 Todos	
F	92-99	YUKON 4x4	
<b>G63612</b> W 141349			
F	87-89	<b>TOYOTA</b> VAN 4x4	
F	88	VAN WAGON Coil (FrontSpringType), Coil (RearSpringType)	

## Lista numérica

Amort.	POP	No. Alternativo	Montaje Accesorio
Pos.	Año	Aplicación	
<b>G63614</b>	A		140780
F 90		<b>FORD BRONCO II</b> Todos	
F 00-05		EXCURSION 4x2 Tracción trasera	
F 90-97		RANGER Todos	
F 94-97		<b>MAZDA B2300</b> Todos	
F 94-97		B3000 Todos	
F 94-97		B4000 Todos	
<b>G63617</b>	W		
F 90-93		<b>FORD PICKUP 1/2 TON, F SUPERDUTY</b> Todos Fab. hasta 2/93	
<b>G63621</b>	W		140780
F 90-97		<b>FORD AEROSTAR 4x4</b>	
F 90-97		AEROSTAR AWD	
<b>G63622</b>	A		142617
F 99-02		<b>FORD ECONOLINE WAGON</b>	
F 99-12		PICKUP 1 TON, F-350 / SUPERDUTY 4x2 Tracción trasera	
F 99-13		PICKUP 3/4 TON, F-250 / SUPERDUTY 4x2 Tracción trasera	
F 08-11		VAN 1/2 TON, ECONOLINE / CLUB WAGON Todos	
F 04-11		VAN 1 TON, ECONOLINE / CLUB WAGON / SUPERDUTY Todos	
F 07		VAN 1 TON, ECONOLINE / CLUB WAGON / SUPERDUTY Todos Exc. Paquete de Ambulancia & Manejo	
F 92-05		VAN 1 TON, ECONOLINE / CLUB WAGON / SUPERDUTY Todos Conversión a Motorhome	
F 92-11		VAN 3/4 TON, ECONOLINE / CLUB WAGON / SUPERDUTY Todos	
<b>G63623</b>	C		142617
R 08-11		<b>FORD VAN 1/2 TON, ECONOLINE / CLUB WAGON</b> Todos	
R 04-11		VAN 1 TON, ECONOLINE / CLUB WAGON / SUPERDUTY Todos Exc. Paquete de Ambulancia & Manejo	
R 92-05		VAN 1 TON, ECONOLINE / CLUB WAGON / SUPERDUTY Todos Conversión a Motorhome	
R 92-11		VAN 3/4 TON, ECONOLINE / CLUB WAGON / SUPERDUTY Todos	
<b>G63624</b>	C		140780
R 92-07		<b>FORD VAN 1/2 TON, ECONOLINE / CLUB WAGON</b> Todos	
<b>G63625</b>	D		140702
F 86-99		<b>GMC VAN 1 TON, P SERIES</b> Todos Chasis Motorhome c/ Eje de Viga Delantero en I	
<b>G63626</b>	D		
R 93-94		<b>JEEP GRAND CHEROKEE</b> Todos	
<b>G63635</b>	D		140524
F 87-93		<b>MAZDA B2600 4x4</b>	
<b>G63638</b>	B		
R 99-00		<b>CADILLAC ESCALADE</b> Todos	
R 92-94		<b>CHEVROLET BLAZER 4x4</b> Automóvil Grande	
R 92-99		SUBURBAN 1/2 TON, K15 / K1500 Todos	
R 92-99		SUBURBAN 3/4 TON, K25 / K2500 Todos	
R 95-00		TAHOE 4x4 Old Body Style	
R 97-02		VAN 1 TON, G / EXPRESS Todos Exc. PBV 8600 #	
R 96-02		VAN 3/4 TON, G / EXPRESS Todos Exc. PBV 8600 #	
R 92-99		<b>GMC SUBURBAN 1/2 TON, K15 / K1500</b> Todos	
R 92-99		SUBURBAN 3/4 TON, K25 / K2500 Todos	
R 96-02		VAN 1 TON, G / SAVANNA Todos Exc. PBV 8600 #	
R 96-02		VAN 3/4 TON, G / SAVANNA Todos Exc. PBV 8600 #	
<b>G63639</b>	W		140169
R 87-93		<b>MAZDA B2600 4x4</b>	
<b>G63660</b>	D		
R 93-98		<b>TOYOTA T100 4x4</b>	
<b>G63661</b>	B		143000
F 94-01		<b>DODGE PICKUP 1/2 TON, RAM 1500 4x2</b> Tracción trasera	
F 94-02		PICKUP 1 TON, RAM 3500 4x2 Tracción trasera Exc. Eje Delantero Rígido	

## Amortiguadores para Camioneta Ultra

Amort.	POP	No. Alternativo	Montaje Accesorio
Pos.	Año	Aplicación	
<b>G63661</b>	B	-continued	143000
F 94-02		PICKUP 3/4 TON, RAM 2500 4x2 Tracción trasera	
<b>G63662</b>	A		
R 03-07		<b>CHEVROLET CHEYENNE</b> PICKUP 1/2 TON, SILVERADO 1500 Classic Hybrid, 4x2 Tracción trasera Exc. Suspensión Electrónica Ajustable	
R 07		PICKUP 1/2 TON, SILVERADO 1500 Classic LS, 4x2 Tracción trasera Exc. Suspensión Electrónica Ajustable	
R 07		PICKUP 1/2 TON, SILVERADO 1500 Classic LT, 4x2 Tracción trasera Exc. Suspensión Electrónica Ajustable	
R 07		PICKUP 1/2 TON, SILVERADO 1500 Classic SS, 4x2 Tracción trasera Exc. Suspensión Electrónica Ajustable	
R 07		PICKUP 1/2 TON, SILVERADO 1500 Classic WT, 4x2 Tracción trasera Exc. Suspensión Electrónica Ajustable	
R 99-06		PICKUP 1/2 TON, SILVERADO 1500 4x2 Tracción trasera Exc. Suspensión Electrónica Ajustable	
R 00-02		SONORA Todos	
R 94-01		<b>DODGE PICKUP 1/2 TON, RAM 1500</b> Todos	
R 94-02		PICKUP 1 TON, RAM 3500 4x2 Tracción trasera Exc. Eje Delantero Rígido	
R 94-03		PICKUP 3/4 TON, RAM 2500 4x4, GAS Exc. PBV 8600 #	
R 94-02		PICKUP 3/4 TON, RAM 2500 4x2 Tracción trasera	
R 95-96		PICKUP 3/4 TON, RAM 2500 4x4, CNG Exc. PBV 8600 #	
R 99-01		RAMCHARGER Todos	
R 07		<b>GMC SIERRA 1500 Classic Hybrid, 4x2</b> Tracción trasera Exc. Suspensión Electrónica Ajustable	
R 07		SIERRA 1500 Classic SL, 4x2 Tracción trasera Exc. Suspensión Electrónica Ajustable	
R 07		SIERRA 1500 Classic SLE, 4x2 Tracción trasera Exc. Suspensión Electrónica Ajustable	
R 07		SIERRA 1500 Classic SLT, 4x2 Tracción trasera Exc. Suspensión Electrónica Ajustable	
R 07		SIERRA 1500 Classic WT, 4x2 Tracción trasera Exc. Suspensión Electrónica Ajustable	
R 99-06		SIERRA 1500 4x2 Tracción trasera Exc. Suspensión Electrónica Ajustable	
<b>G63671</b>	W		
R 92-96		<b>CHEVROLET VAN 1 TON, G / EXPRESS</b> Cutaway Van	
R 92-96		<b>GMC VAN 1 TON, G / SAVANNA</b> Cutaway Van	
<b>G63673</b>	C		143000
F 94-01		<b>DODGE PICKUP 1/2 TON, RAM 1500 4x4</b>	
F 94-02		PICKUP 3/4 TON, RAM 2500 4x4, GAS Exc. PBV 8600 #	
F 95-96		PICKUP 3/4 TON, RAM 2500 4x4, CNG Exc. PBV 8600 #	
<b>G63674</b>	B		142731
F 94-02		<b>DODGE PICKUP 1 TON, RAM 3500 4x4</b>	
F 94-02		PICKUP 1 TON, RAM 3500 4x2 Tracción trasera Eje Delantero Rígido	
F 94-02		PICKUP 3/4 TON, RAM 2500 4x4, DIESEL PBV 8800	
F 05-08		RAM 4000 Todos	
<b>G63675</b>	A		
R 03-07		<b>CHEVROLET CHEYENNE</b> PICKUP 1/2 TON, SILVERADO 1500 Classic Hybrid, 4x4 Estilo Carrocería Clásica y Antigua, Exc. Suspensión Electrónica Ajustable	
R 07		PICKUP 1/2 TON, SILVERADO 1500 Classic LS, 4x4 Estilo Carrocería Clásica y Antigua, Exc. Suspensión Electrónica Ajustable	

## Lista numérica

Amort.	POP	No. Alternativo	Montaje Accesorio
Pos.	Año	Aplicación	
<b>G63675</b>	A	-continued	
R 07		PICKUP 1/2 TON, SILVERADO 1500 Classic LT, 4x4 Estilo Carrocería Clásica y Antigua, Exc. Suspensión Electrónica Ajustable	
R 07		PICKUP 1/2 TON, SILVERADO 1500 Classic WT, 4x4 Estilo Carrocería Clásica y Antigua, Exc. Suspensión Electrónica Ajustable	
R 99-06		PICKUP 1/2 TON, SILVERADO 1500 4x4 Estilo Carrocería Clásica y Antigua, Exc. Suspensión Electrónica Ajustable	
R 05-07		PICKUP 1/2 TON, SILVERADO 1500 HD Todos	
R 01-03		PICKUP 1/2 TON, SILVERADO 1500 HD Todos	
R 77-86		PICKUP 1 TON, K30 Todos	
R 90-91		PICKUP 1 TON, R3500 Todos	
R 89		PICKUP 1 TON, R3500 Cab & Chassis, 4x2 Tracción trasera	
R 89		PICKUP 1 TON, R3500 Crew Cab Pickup, 4x2 Tracción trasera	
R 01-09		PICKUP 1 TON, SILVERADO 3500 Todos	
R 07-10		PICKUP 1 TON, SILVERADO 3500 HD Todos	
R 87-88		PICKUP 1 TON, V30 Todos	
R 89-91		PICKUP 1 TON, V3000 / V3500 Todos	
R 99-08		PICKUP 3/4 TON, SILVERADO 2500 Todos	
R 01-10		PICKUP 3/4 TON, SILVERADO 2500 HD Todos	
R 02-05		<b>DODGE PICKUP 1/2 TON, RAM 1500</b> Todos	
R 94-02		PICKUP 1 TON, RAM 3500 4x4	
R 94-02		PICKUP 1 TON, RAM 3500 4x2 Tracción trasera Eje Delantero Rígido	
R 94-02		PICKUP 3/4 TON, RAM 2500 4x4, DIESEL PBV 8800	
R 05-08		RAM 4000 Todos	
R 77-86		<b>GMC PICKUP 1 TON, K35 / K3500</b> Todos	
R 87-91		PICKUP 1 TON, V3000 / V3500 Todos	
R 07		SIERRA 1500 Classic Hybrid, 4x4 Estilo Carrocería Clásica y Antigua, Exc. Suspensión Electrónica Ajustable	
R 07		SIERRA 1500 Classic SL, 4x4 Estilo Carrocería Clásica y Antigua, Exc. Suspensión Electrónica Ajustable	
R 07		SIERRA 1500 Classic SLE, 4x4 Estilo Carrocería Clásica y Antigua, Exc. Suspensión Electrónica Ajustable	
R 07		SIERRA 1500 Classic SLT, 4x4 Estilo Carrocería Clásica y Antigua, Exc. Suspensión Electrónica Ajustable	
R 07		SIERRA 1500 Classic WT, 4x4 Estilo Carrocería Clásica y Antigua, Exc. Suspensión Electrónica Ajustable	
R 99-06		SIERRA 1500 4x4 Estilo Carrocería Clásica y Antigua, Exc. Suspensión Electrónica Ajustable	
R 05-07		SIERRA 1500 HD Todos	
R 01-03		SIERRA 1500 HD Todos	
R 99-04		SIERRA 2500 Todos	
R 01-10		SIERRA 2500 HD Todos	
R 01-07		SIERRA 3500 Todos	
R 07-10		SIERRA 3500 HD Todos	
<b>G63678</b>	A		142277
F 95-01		<b>FORD EXPLORER</b> Todos Exc. Suspensión de Aire	
F 98		EXPLORER Todos	
F 01-05		EXPLORER SPORT TRAC Todos	
F 06-11		RANGER 4x2 Tracción trasera, Barra de Torsion (FrontSpringType)	
F 98-11		RANGER 4x4	
F 01-05		RANGER Edge, 4x2 Tracción trasera	
F 03-06		<b>MAZDA B3000</b> Todos 4x4	
F 98-02		B3000 4x4	
F 98-06		B4000 4x4	
<b>G63679</b>	A		140719
R 95-01		<b>FORD EXPLORER</b> Todos Exc. Suspensión de Aire	
R 98		EXPLORER Todos	
R 01-05		EXPLORER SPORT TRAC Todos	



## Lista numérica

Amort.	POP	No. Alternativo	Montaje Accesorio
Pos.	Año	Aplicación	
<b>G63683</b>	B		
R	95-98	<b>JEEP GRAND CHEROKEE</b> Todos	
<b>G63689</b>	B		
R	01-04	<b>TOYOTA TACOMA S-Runner</b>	
R	04	<b>TACOMA Base, 4x2 Tracción trasera</b>	
R	95-03	<b>TACOMA DLX, 4x2 Tracción trasera</b>	
<b>G63692</b>	W		
F	93-97	<b>FORD PICKUP 1/2 TON, F SUPERDUTY</b> Todos Fab. desde 2/93	
F	97	<b>PICKUP, F-450 SUPERDUTY</b> Todos	
<b>G63714</b>	A		142731
F	96	<b>FORD EXPEDITION</b>	
F	97-02	<b>EXPEDITION 4x2 Tracción trasera</b> Exc. Nivelación Neumática Delantera	
F	97-04	<b>PICKUP 1/2 TON, F-150 4x2 Tracción trasera</b>	
F	97-99	<b>PICKUP 3/4 TON, F-250 / SUPERDUTY 4x2 Tracción trasera</b> Hasta PBV 8500#	
F	98-02	<b>LINCOLN NAVIGATOR 4x2 Tracción trasera</b>	
<b>G63715</b>	B		142700
R	97-04	<b>FORD PICKUP 1/2 TON, F-150 4x4</b> Exc. PBV 7700#	
R	97-99	<b>PICKUP 3/4 TON, F-250 / SUPERDUTY 4x4</b> Hasta PBV 8500#, Exc. Superduty	
<b>G63716</b>	A		142731
F	97-02	<b>FORD EXPEDITION 4x4</b> Exc. Nivelación Neumática Delantera	
F	04	<b>PICKUP 1/2 TON, F-150 4x4</b> Exc. PBV 7700#	
F	97-03	<b>PICKUP 1/2 TON, F-150 4x4</b>	
F	97-99	<b>PICKUP 3/4 TON, F-250 / SUPERDUTY 4x4</b> Hasta PBV 8500#, Exc. Superduty	
<b>G63717</b>	B		
R	97-02	<b>FORD EXPEDITION</b> Todos	
R	98-02	<b>LINCOLN NAVIGATOR 4x2 Tracción trasera</b>	
<b>G63721</b>	D		141665
F	97-06	<b>JEEP WRANGLER TJ</b> (Código plataforma del fabricante)	
<b>G63722</b>	D		
R	97-06	<b>JEEP WRANGLER TJ</b> (Código plataforma del fabricante)	
<b>G63726</b>	D		140921
R	96-02	<b>TOYOTA 4RUNNER</b> Todos	
<b>G63772</b>	A		141665
F	06-11	<b>FORD RANGER 4x2 Tracción trasera, Coil (FrontSpringType)</b>	
F	98-05	<b>RANGER XL, 4x2 Tracción trasera</b>	
F	98-05	<b>RANGER XLT, 4x2 Tracción trasera</b>	
F	05	<b>RANGER STX, 4x2 Tracción trasera</b>	
F	04	<b>RANGER Tremor, 4x2 Tracción trasera</b>	
F	01-06	<b>MAZDA B2300 4x2 Tracción trasera</b>	
F	98-01	<b>B2500 4x2 Tracción trasera</b>	
F	98-06	<b>B3000 4x2 Tracción trasera</b>	
F	98-06	<b>B4000 4x2 Tracción trasera</b>	
<b>G63773</b>	B		
R	06-11	<b>FORD RANGER 4x2 Tracción trasera, Coil (FrontSpringType)</b>	
R	98-05	<b>RANGER XL, 4x2 Tracción trasera</b>	
R	98-05	<b>RANGER XLT, 4x2 Tracción trasera</b>	
R	05	<b>RANGER STX, 4x2 Tracción trasera</b>	
R	04	<b>RANGER Tremor, 4x2 Tracción trasera</b>	
R	01-06	<b>MAZDA B2300 4x2 Tracción trasera</b>	
R	98-01	<b>B2500 4x2 Tracción trasera</b>	
R	98-06	<b>B3000 4x2 Tracción trasera</b>	
R	98-06	<b>B4000 4x2 Tracción trasera</b>	
<b>G63775</b>	B		
R	06-11	<b>FORD RANGER 4x2 Tracción trasera, Barra de Torsion (FrontSpringType)</b>	
R	98-11	<b>RANGER 4x4</b>	
R	01-05	<b>RANGER Edge, 4x2 Tracción trasera</b>	
R	03-06	<b>MAZDA B3000</b> Todos 4x4	
R	98-02	<b>B3000 4x4</b>	
R	98-06	<b>B4000 4x4</b>	

## Amortiguadores para Camioneta Ultra

Amort.	POP	No. Alternativo	Montaje Accesorio
Pos.	Año	Aplicación	
<b>G63776</b>	B		
R	07-09	<b>CHEVROLET UPLANDER</b> Todos Exc. Suspensión con Nivelación Neumática	
R	05-06	<b>UPLANDER 4x2 Tracción delantera</b> Exc. Suspensión con Nivelación Neumática	
<b>G63778</b>	B		142700
R	04	<b>FORD PICKUP 1/2 TON, F-150 4x2 Tracción trasera</b>	
R	00-03	<b>PICKUP 1/2 TON, F-150 Harley-Davidson Edition, 4x2 Tracción trasera</b>	
R	99-03	<b>PICKUP 1/2 TON, F-150 Lariat, 4x2 Tracción trasera</b>	
R	99-03	<b>PICKUP 1/2 TON, F-150 XL, 4x2 Tracción trasera</b>	
R	99-03	<b>PICKUP 1/2 TON, F-150 XLT, 4x2 Tracción trasera</b>	
R	00	<b>PICKUP 1/2 TON, F-150 Base, 4x2 Tracción trasera</b>	
R	97-98	<b>PICKUP 1/2 TON, F-150 4x2 Tracción trasera</b>	
R	97-99	<b>PICKUP 3/4 TON, F-250 / SUPERDUTY 4x2 Tracción trasera</b> Hasta PBV 8500#	
<b>G63783</b>	B		141665
F	03-07	<b>CHEVROLET CHEYENNE</b>	
F	07	<b>PICKUP 1/2 TON, SILVERADO 1500 Classic Hybrid, 4x2 Tracción trasera</b>	
F	07	<b>PICKUP 1/2 TON, SILVERADO 1500 Classic LS, 4x2 Tracción trasera</b>	
F	07	<b>PICKUP 1/2 TON, SILVERADO 1500 Classic LT, 4x2 Tracción trasera</b>	
F	07	<b>PICKUP 1/2 TON, SILVERADO 1500 Classic SS, 4x2 Tracción trasera</b>	
F	07	<b>PICKUP 1/2 TON, SILVERADO 1500 Classic WT, 4x2 Tracción trasera</b>	
F	99-06	<b>PICKUP 1/2 TON, SILVERADO 1500 4x2 Tracción trasera</b> Exc. Suspensión Electrónica Ajustable	
F	00-02	<b>SONORA</b> Todos	
F	07	<b>GMC SIERRA 1500 Classic Hybrid, 4x2 Tracción trasera</b> Exc. Suspensión Electrónica Ajustable	
F	07	<b>SIERRA 1500 Classic SL, 4x2 Tracción trasera</b> Exc. Suspensión Electrónica Ajustable	
F	07	<b>SIERRA 1500 Classic SLE, 4x2 Tracción trasera</b> Exc. Suspensión Electrónica Ajustable	
F	07	<b>SIERRA 1500 Classic SLT, 4x2 Tracción trasera</b> Exc. Suspensión Electrónica Ajustable	
F	07	<b>SIERRA 1500 Classic WT, 4x2 Tracción trasera</b> Exc. Suspensión Electrónica Ajustable	
F	99-06	<b>SIERRA 1500 4x2 Tracción trasera</b> Exc. Suspensión Electrónica Ajustable	
<b>G63803</b>	A		141665
F	02-06	<b>CHEVROLET AVALANCHE 1500</b> Todos Exc. Control de Manejo Electrónico	
F	03-07	<b>CHEYENNE</b>	
F	07	<b>PICKUP 1/2 TON, SILVERADO 1500 Classic Hybrid, 4x4 Estilo Carrocería Clásica y Antigua, Exc. Suspensión Electrónica Ajustable</b>	
F	07	<b>PICKUP 1/2 TON, SILVERADO 1500 Classic LS, 4x4 Estilo Carrocería Clásica y Antigua, Exc. Suspensión Electrónica Ajustable</b>	
F	07	<b>PICKUP 1/2 TON, SILVERADO 1500 Classic LT, 4x4 Estilo Carrocería Clásica y Antigua, Exc. Suspensión Electrónica Ajustable</b>	
F	07	<b>PICKUP 1/2 TON, SILVERADO 1500 Classic WT, 4x4 Estilo Carrocería Clásica y Antigua, Exc. Suspensión Electrónica Ajustable</b>	
F	99-06	<b>PICKUP 1/2 TON, SILVERADO 1500 4x4 Estilo Carrocería Clásica y Antigua, Exc. Suspensión Electrónica Ajustable</b>	
F	00-06	<b>SUBURBAN 1/2 TON, 1500</b> Todos Exc. Suspensión Z55 Auto Ride	

## Lista numérica

Amort.	POP	No. Alternativo	Montaje Accesorio
Pos.	Año	Aplicación	
<b>G63803</b>	A	-continued	141665
F	02-06	<b>TAHOE</b> Todos Exc. Suspensión Z55 Auto Ride	
F	00-01	<b>TAHOE</b> Todos Estilo New Body, Exc. Suspensión Z55	
F	07	<b>GMC SIERRA 1500 Classic Hybrid, 4x4 Estilo Carrocería Clásica y Antigua, Exc. Suspensión Electrónica Ajustable</b>	
F	07	<b>SIERRA 1500 Classic SL, 4x4 Estilo Carrocería Clásica y Antigua, Exc. Suspensión Electrónica Ajustable</b>	
F	07	<b>SIERRA 1500 Classic SLE, 4x4 Estilo Carrocería Clásica y Antigua, Exc. Suspensión Electrónica Ajustable</b>	
F	07	<b>SIERRA 1500 Classic SLT, 4x4 Estilo Carrocería Clásica y Antigua, Exc. Suspensión Electrónica Ajustable</b>	
F	07	<b>SIERRA 1500 Classic WT, 4x4 Estilo Carrocería Clásica y Antigua, Exc. Suspensión Electrónica Ajustable</b>	
F	99-06	<b>SIERRA 1500 4x4 Estilo Carrocería Clásica y Antigua, Exc. Suspensión Electrónica Ajustable</b>	
F	00-06	<b>YUKON</b> Todos Exc. Suspensión Z55 Auto Ride	
F	00-06	<b>YUKON XL 1/2 TON</b> Todos Exc. Suspensión Z55 Auto Ride	
<b>G63808</b>	C		
R	99-04	<b>FORD PICKUP 1 TON, F-350 / SUPERDUTY 4x2 Tracción trasera</b>	
R	99-04	<b>PICKUP 3/4 TON, F-250 / SUPERDUTY 4x2 Tracción trasera</b>	
<b>G63809</b>	C		
F	00-05	<b>FORD EXCURSION 4x4</b>	
F	99-04	<b>PICKUP 1 TON, F-350 / SUPERDUTY 4x4</b>	
F	99-04	<b>PICKUP 3/4 TON, F-250 / SUPERDUTY 4x4</b>	
F	99-04	<b>PICKUP, F-450 SUPERDUTY</b> Todos	
F	99-04	<b>PICKUP, F-550 SUPERDUTY</b> Todos	
<b>G63810</b>	D		
R	99-04	<b>FORD PICKUP 1 TON, F-350 / SUPERDUTY 4x4</b>	
R	99-04	<b>PICKUP 3/4 TON, F-250 / SUPERDUTY 4x4</b>	
<b>G63811</b>	D		
R	99-04	<b>FORD PICKUP, F-450 SUPERDUTY</b> Todos	
R	99-04	<b>PICKUP, F-550 SUPERDUTY</b> Todos	
<b>G63812</b>	B		
F	01-02	<b>CHEVROLET PICKUP 1 TON, C35/3500</b> Todos Eje Delantero Rígido HD	
F	91-00	<b>PICKUP 1 TON, C35/3500</b> Cab & Chassis Eje Delantero Rígido HD	
F	91-00	<b>GMC PICKUP 1 TON, C35/3500</b> Cab & Chassis Eje Delantero Rígido HD	
<b>G63813</b>	B		142389
F	00-04	<b>NISSAN FRONTIER</b> Crew Cab Pickup, 4x2 Tracción trasera con Desert Runner	
F	98-04	<b>FRONTIER 4x4</b>	
F	98-99	<b>FRONTIER 4x2 Tracción trasera</b> Crew Cab con Desert Runner	
<b>G63815</b>	C		142389
R	00-06	<b>TOYOTA TUNDRA</b> Todos	
<b>G63817</b>	A		141665
F	02-06	<b>CHEVROLET AVALANCHE 2500</b> Todos Exc. Control de Manejo Electrónico	
F	05-07	<b>PICKUP 1/2 TON, SILVERADO 1500 HD</b> Todos	
F	01-03	<b>PICKUP 1/2 TON, SILVERADO 1500 HD</b> Todos	
F	01-09	<b>PICKUP 1 TON, SILVERADO 3500</b> Todos	
F	07-10	<b>PICKUP 1 TON, SILVERADO 3500 HD</b> Todos	
F	05-08	<b>PICKUP 3/4 TON, SILVERADO 2500</b> Todos	
F	99-04	<b>PICKUP 3/4 TON, SILVERADO 2500 4x4</b>	
F	01-10	<b>PICKUP 3/4 TON, SILVERADO 2500 HD</b> Todos PBV 9200	

## Lista numérica

Amort.	POP	No. Alternativo	Montaje Accesorio
Pos.	Año	Aplicación	
<b>G63817</b>	A	-continued	141665
F	00-11	SUBURBAN 3/4 TON, 2500 Todos Exc. Suspensión Auto Ride Z55 y Quadrasteer	
F	05-07	<b>GMC SIERRA 1500 HD</b> Todos	
F	01-03	SIERRA 1500 HD Todos	
F	99-04	SIERRA 2500 4x4	
F	01-10	SIERRA 2500 HD Todos	
F	01-07	SIERRA 3500 Todos	
F	07-10	SIERRA 3500 HD Barra de Torsion (FrontSpringType)	
F	00-06	YUKON XL 3/4 TON Todos Exc. Sistema de Autonivelación NIVOMAT	
F	03-06	<b>HUMMER H2</b> Todos	
<b>G63818</b>	B		
F	90-05	<b>CHEVROLET ASTRO AWD</b>	
F	88-99	PICKUP 1/2 TON, K15 / K1500 Todos	
F	88-99	<b>GMC PICKUP 1/2 TON, K15 / K1500</b> Todos	
F	90-05	SAFARI AWD	
<b>G63829</b>	B		
R	99-04	<b>JEEP GRAND CHEROKEE</b> Todos	
<b>G63837</b>	W		
R	00-05	<b>FORD EXCURSION</b> 4x4	
<b>G63842</b>	C		
R	02-09	<b>CHEVROLET TRAILBLAZER</b> Coil (RearSpringType)	
R	02-09	<b>GMC ENVÓY</b> Coil (RearSpringType)	
<b>G63844</b>	B		
R	02-12	<b>JEEP LIBERTY</b> Todos	
<b>G63847</b>	B		141353,142592
F	99-04	<b>JEEP GRAND CHEROKEE</b> Todos Exc. Suspensión Up Country	
<b>G63848</b>	C		142731
F	02-05	<b>DODGE PICKUP 1/2 TON, RAM</b> 1500 4x4	
<b>G63862</b>	C		140455
R	01-07	<b>FORD ESCAPE</b> Todos	
<b>G63866</b>	B		
R	02-13	<b>CADILLAC ESCALADE</b> Todos	
R	07-11	<b>CHEVROLET AVALANCHE 1500</b> Todos Exc. Suspensión Z55 o ZW7	
R	02-06	AVALANCHE 1500 Todos Exc. Control de Manejo Electrónico	
R	02-06	AVALANCHE 2500 Todos Exc. Control de Manejo Electrónico	
R	07-11	SUBURBAN 1/2 TON, 1500 Todos Exc. Suspensión Z55 o ZW7	
R	00-06	SUBURBAN 1/2 TON, 1500 Todos Exc. Suspensión Z55 Auto Ride	
R	00-11	SUBURBAN 3/4 TON, 2500 Todos Exc. Suspensión Auto Ride Z55 y Quadrasteer	
R	02-11	TAHOE Todos Exc. Suspensión Z55 o ZW7	
R	00-01	TAHOE Todos Estilo New Body, Exc. Suspensión Z55	
R	07-11	<b>GMC YUKON</b> Todos Exc. Suspensión Z55 o ZW7	
R	00-06	YUKON Todos Exc. Suspensión Z55 Auto Ride	
R	07-11	YUKON XL 1/2 TON Todos Exc. Suspensión Z55 o ZW7	
R	00-06	YUKON XL 1/2 TON Todos Exc. Suspensión Z55 Auto Ride	
R	00-06	YUKON XL 3/4 TON Todos Exc. Sistema de Autonivelación NIVOMAT	
<b>G63867</b>	C		
R	09-10	<b>FORD PICKUP 1/2 TON, F-150</b> 4x2 Tracción trasera	
R	04-08	PICKUP 1/2 TON, F-150 4x4	
R	06-08	<b>LINCOLN MARK LT</b> 4x4	
<b>G63870</b>	B		
R	05-08	<b>FORD PICKUP 1/2 TON, F-150</b> 4x2 Tracción trasera	
R	04	PICKUP 1/2 TON, F-150 Lariat, 4x2 Tracción trasera	
R	04	PICKUP 1/2 TON, F-150 STX, 4x2 Tracción trasera	
R	04	PICKUP 1/2 TON, F-150 XL, 4x2 Tracción trasera	
R	04	PICKUP 1/2 TON, F-150 XLT, 4x2 Tracción trasera	

## Amortiguadores para Camioneta Ultra

Amort.	POP	No. Alternativo	Montaje Accesorio
Pos.	Año	Aplicación	
<b>G63870</b>	B	-continued	
R	06-08	<b>LINCOLN MARK LT 4x2</b> Tracción trasera	
<b>G63878</b>	D		
R	04-11	<b>NISSAN TITAN</b> 4x4	
<b>G63879</b>	C		
R	04-11	<b>CHEVROLET COLORADO</b> Barra de Torsion (FrontSpringType)	
R	04-11	<b>GMC CANYON</b> Barra de Torsion (FrontSpringType)	
R	06	<b>ISUZU I-350</b> Barra de Torsion (FrontSpringType)	
<b>G63882</b>	C		
R	04-11	<b>CHEVROLET COLORADO 4x2</b> Tracción trasera, Coil (FrontSpringType) Exc. Paquete Z71 Off Road	
R	04-11	<b>GMC CANYON 4x2</b> Tracción trasera, Coil (FrontSpringType) Exc. Paquete Z71 Off Road	
R	06	<b>ISUZU I-280</b> Todos	
<b>G63883</b>	D		
R	04-11	<b>NISSAN TITAN 4x2</b> Tracción trasera	
<b>G63884</b>	C		143312
F	04-08	<b>CHEVROLET COLORADO</b> Barra de Torsion (FrontSpringType)	
F	04-08	<b>GMC CANYON</b> Barra de Torsion (FrontSpringType)	
F	06	<b>ISUZU I-350</b> Barra de Torsion (FrontSpringType)	
<b>G63885</b>	W		142280
R	10-11	<b>TOYOTA 4RUNNER</b> Trail	
R	03-11	4RUNNER Limited	
R	03-11	4RUNNER SR5	
<b>G63886</b>	C		142731
F	05-12	<b>FORD PICKUP 1 TON, F-350 / SUPERDUTY 4x4</b>	
F	05-13	PICKUP 3/4 TON, F-250 / SUPERDUTY 4x4	
<b>G63887</b>	W		
R	05-07	<b>FORD PICKUP 1 TON, F-350 / SUPERDUTY</b> Crew Cab Pickup, 4x4 Doble Rodada Trasera	
R	05-07	PICKUP 1 TON, F-350 / SUPERDUTY Extended Cab Pickup, 4x4 Doble Rodada Trasera	
R	05-07	PICKUP 1 TON, F-350 / SUPERDUTY Standard Cab Pickup, 4x4 Doble Rodada Trasera	
<b>G63888</b>	D		
R	05-12	<b>FORD PICKUP 1 TON, F-350 / SUPERDUTY</b> Crew Cab Pickup, 4x4 Rodada Trasera Sencilla	
R	05-12	PICKUP 1 TON, F-350 / SUPERDUTY Extended Cab Pickup, 4x4 Rodada Trasera Sencilla	
R	05-12	PICKUP 1 TON, F-350 / SUPERDUTY Standard Cab Pickup, 4x4 Rodada Trasera Sencilla	
R	05-13	PICKUP 3/4 TON, F-250 / SUPERDUTY 4x4	
<b>G63889</b>	C		141041
R	05-13	<b>TOYOTA TACOMA</b> Base, 4x2 Tracción trasera	
<b>G63890</b>	C		
R	06-09	<b>MITSUBISHI RAIDER 4x2</b> Tracción trasera	
<b>G63891</b>	D		
R	06-09	<b>MITSUBISHI RAIDER 4x4</b>	
<b>G63893</b>	C		143276
F	03-11	<b>CHEVROLET VAN 1/2 TON, G / EXPRESS</b> Barra de Torsion (FrontSpringType)	
F	03-12	VAN 1 TON, G / EXPRESS Todos Barra de Torsion (Suspensión de Resorte Delantera)	
F	06-12	VAN 3/4 TON, G / EXPRESS Todos Barra de Torsion (Suspensión de Resorte Delantera)	
F	03-05	VAN 3/4 TON, G / EXPRESS Barra de Torsion (FrontSpringType)	
F	03-11	<b>GMC VAN 1/2 TON, G / SAVANNA</b> Barra de Torsion (FrontSpringType)	

## Lista numérica

Amort.	POP	No. Alternativo	Montaje Accesorio
Pos.	Año	Aplicación	
<b>G63893</b>	C	-continued	143276
F	03-12	VAN 1 TON, G / SAVANNA Todos Barra de Torsion (Suspensión de Resorte Delantera)	
F	04-12	VAN 3/4 TON, G / SAVANNA Todos Barra de Torsion (Suspensión de Resorte Delantera)	
F	03	VAN 3/4 TON, G / SAVANNA Barra de Torsion (FrontSpringType)	
<b>G63894</b>	B		143276
F	03-11	<b>CHEVROLET VAN 1/2 TON, G / EXPRESS</b> 4x2 Tracción trasera, Coil (FrontSpringType)	
F	03-11	<b>GMC VAN 1/2 TON, G / SAVANNA</b> 4x2 Tracción trasera, Coil (FrontSpringType)	
<b>G63895</b>	C		143276
F	03-12	<b>CHEVROLET VAN 1 TON, G / EXPRESS</b> Coil (FrontSpringType)	
F	03-12	VAN 3/4 TON, G / EXPRESS Coil (FrontSpringType)	
F	03-12	<b>GMC VAN 1 TON, G / SAVANNA</b> Coil (FrontSpringType)	
F	03-12	VAN 3/4 TON, G / SAVANNA Coil (FrontSpringType)	
<b>G63896</b>	C		
R	92-99	<b>CHEVROLET SUBURBAN 1/2 TON, C15 / C1500</b> Todos	
R	92-99	SUBURBAN 3/4 TON, C25 / C2500 Todos	
R	95-00	TAHOE 4x2 Tracción trasera Old Body Style	
R	96-11	VAN 1/2 TON, G / EXPRESS Todos	
R	93-99	<b>GMC SUBURBAN 1/2 TON, C15 / C1500</b> Todos	
R	92	SUBURBAN 1/2 TON, C15 / C1500 Todos Old Body Style	
R	92-99	SUBURBAN 3/4 TON, C25 / C2500 Todos	
R	96-11	VAN 1/2 TON, G / SAVANNA Todos	
R	00	YUKON Denali	
R	92-99	YUKON Todos	
<b>G63897</b>	C		
R	03-12	<b>CHEVROLET VAN 1 TON, G / EXPRESS</b> Todos Rodada Trasera Sencilla	
R	03-12	VAN 3/4 TON, G / EXPRESS Todos	
R	03-12	<b>GMC VAN 1 TON, G / SAVANNA</b> Todos Rodada Trasera Sencilla	
R	03-12	VAN 3/4 TON, G / SAVANNA Todos	
<b>G63898</b>	W		
R	03-06	<b>CHEVROLET VAN 1 TON, G / EXPRESS</b> Todos Doble Rodada Trasera	
R	03-06	<b>GMC VAN 1 TON, G / SAVANNA</b> Todos Doble Rodada Trasera	
<b>G63900</b>	W		140673
F	87-89	<b>TOYOTA VAN 4x2</b> Tracción trasera	
F	84-86	VAN Todos	
F	88	VAN WAGON Leaf (FrontSpringType), Leaf (RearSpringType)	
<b>G63902</b>	A		140857
F	81-95	<b>ISUZU PICKUP 4x2</b> Tracción trasera	
F	05-12	<b>NISSAN PICKUP</b>	
F	98-04	PICKUP Todos	
F	95-97	PICKUP 4x4	
F	65-97	PICKUP	
<b>G63903</b>	A		141376
F	85-95	<b>TOYOTA PICKUP 4x2</b> Tracción trasera Exc. 1 Ton	
F	84	PICKUP 4x2 Tracción trasera	
F	93-98	T100 4x2 Tracción trasera	
<b>G63904</b>	B		141356
F	87-90	<b>MITSUBISHI VAN</b> Todos	
<b>G63906</b>	W		
F	87-91	<b>CHEVROLET BLAZER 4x4</b> Automóvil Grande; Suspensión Quad Amortiguador Largo; Exc. Kit de Levantamiento	
F	81-86	BLAZER 4x4 Suspensión Quad Amortiguador Largo; Exc. Kit de Levantamiento	
F	81-86	PICKUP 1/2 TON, K10 Todos Suspensión Quad Amortiguador Largo; Exc. Kit de Levantamiento	

Lista numérica

Amort.	POP	No. Alternativo	Montaje Accesorio
Pos.	Año	Aplicación	
<b>G63906</b>	W	-continued	
F	87	PICKUP 1/2 TON, V10 Todos Suspensión Quad Amortiguador Largo; Exc. Kit de Levantamiento	
F	81-86	PICKUP 3/4 TON, K20 Todos Suspensión Quad Amortiguador Largo; Exc. Kit de Levantamiento	
F	87	PICKUP 3/4 TON, V20 Todos Suspensión Quad Amortiguador Largo; Exc. Kit de Levantamiento	
F	81-86	SUBURBAN 1/2 TON, K10 Todos Suspensión Quad Amortiguador Largo; Exc. Kit de Levantamiento	
F	89-91	SUBURBAN 1/2 TON, V1500 Todos Suspensión Quad Amortiguador Largo; Exc. Kit de Levantamiento	
F	81-86	SUBURBAN 3/4 TON, K20 Todos Suspensión Quad Amortiguador Largo; Exc. Kit de Levantamiento	
F	87-88	SUBURBAN 3/4 TON, V20 Todos Suspensión Quad Amortiguador Largo; Exc. Kit de Levantamiento	
F	89-91	SUBURBAN 3/4 TON, V2500 Todos Suspensión Quad Amortiguador Largo; Exc. Kit de Levantamiento	
F	73-91	<b>GMC JIMMY</b> 4x4 Suspensión Quad Amortiguador Largo; Exc. Kit de Levantamiento	
F	81-86	PICKUP 1/2 TON, K15 / K1500 Todos Suspensión Quad Amortiguador Largo; Exc. Kit de Levantamiento	
F	87	PICKUP 1/2 TON, V1500 Todos Suspensión Quad Amortiguador Largo; Exc. Kit de Levantamiento	
F	81-86	PICKUP 3/4 TON, K25 / K2500 Todos Suspensión Quad Amortiguador Largo; Exc. Kit de Levantamiento	
F	87	PICKUP 3/4 TON, V2500 Todos Suspensión Quad Amortiguador Largo; Exc. Kit de Levantamiento	
F	81-86	SUBURBAN 1/2 TON, K15 / K1500 Todos Suspensión Quad Amortiguador Largo; Exc. Kit de Levantamiento	
F	87-91	SUBURBAN 1/2 TON, V1500 Todos Suspensión Quad Amortiguador Largo; Exc. Kit de Levantamiento	
F	81-86	SUBURBAN 3/4 TON, K25 / K2500 Todos Suspensión Quad Amortiguador Largo; Exc. Kit de Levantamiento	
F	87-91	SUBURBAN 3/4 TON, V2500 Todos Suspensión Quad Amortiguador Largo; Exc. Kit de Levantamiento	
<b>G63907</b>	A		
R	87-93	<b>DODGE</b> PICKUP, RAM 50 4x2 Tracción trasera	
R	83-86	PICKUP, RAM 50 Todos	
R	86-87	<b>MAZDA</b> B2000 4x2 Tracción trasera	
R	87-93	B2200 4x2 Tracción trasera	
R	87-93	B2600 4x2 Tracción trasera	
R	87-90	<b>MINI</b> VAN Todos	
R	98-04	<b>NISSAN</b> FRONTIER 4x2 Tracción trasera Exc. Desert Runner	
R	05-12	PICKUP	
R	95-04	PICKUP 4x2 Tracción trasera	
R	65-94	PICKUP	
R	85-95	<b>TOYOTA</b> PICKUP 4x2 Tracción trasera Exc. 1 Ton	
R	84	PICKUP 4x2 Tracción trasera	
R	70-83	PICKUP 4x2 Tracción trasera Mojave	
R	84-88	VAN Leaf (RearSpringType)	
R	88	VAN WAGON Leaf (FrontSpringType), Leaf (RearSpringType)	
<b>G63908</b>	W		
F	87-91	<b>CHEVROLET</b> BLAZER 4x4 Automóvil Grande; Suspensión Quad Amortiguador Corto; Exc. Kit de Levantamiento	
F	81-86	BLAZER 4x4 Suspensión Quad Amortiguador Corto; Exc. Kit de Levantamiento	
F	81-86	PICKUP 1/2 TON, K10 Todos Suspensión Quad Amortiguador Corto; Exc. Kit de Levantamiento	
F	87	PICKUP 1/2 TON, V10 Todos Suspensión Quad Amortiguador Corto; Exc. Kit de Levantamiento	

Amortiguadores para Camioneta Ultra

Amort.	POP	No. Alternativo	Montaje Accesorio
Pos.	Año	Aplicación	
<b>G63908</b>	W	-continued	
F	81-86	PICKUP 3/4 TON, K20 Todos Suspensión Quad Amortiguador Corto; Exc. Kit de Levantamiento	
F	87	PICKUP 3/4 TON, V20 Todos Suspensión Quad Amortiguador Corto; Exc. Kit de Levantamiento	
F	81-86	SUBURBAN 1/2 TON, K10 Todos Suspensión Quad Amortiguador Corto; Exc. Kit de Levantamiento	
F	89-91	SUBURBAN 1/2 TON, V1500 Todos Suspensión Quad Amortiguador Corto; Exc. Kit de Levantamiento	
F	81-86	SUBURBAN 3/4 TON, K20 Todos Suspensión Quad Amortiguador Corto; Exc. Kit de Levantamiento	
F	87-88	SUBURBAN 3/4 TON, V20 Todos Suspensión Quad Amortiguador Corto; Exc. Kit de Levantamiento	
F	89-91	SUBURBAN 3/4 TON, V2500 Todos Suspensión Quad Amortiguador Corto; Exc. Kit de Levantamiento	
F	73-91	<b>GMC JIMMY</b> 4x4 Suspensión Quad Amortiguador Corto; Exc. Kit de Levantamiento	
F	81-86	PICKUP 1/2 TON, K15 / K1500 Todos Suspensión Quad Amortiguador Corto; Exc. Kit de Levantamiento	
F	87	PICKUP 1/2 TON, V1500 Todos Suspensión Quad Amortiguador Corto; Exc. Kit de Levantamiento	
F	81-86	PICKUP 3/4 TON, K25 / K2500 Todos Suspensión Quad Amortiguador Corto; Exc. Kit de Levantamiento	
F	87	PICKUP 3/4 TON, V2500 Todos Suspensión Quad Amortiguador Corto; Exc. Kit de Levantamiento	
F	81-86	SUBURBAN 1/2 TON, K15 / K1500 Todos Suspensión Quad Amortiguador Corto; Exc. Kit de Levantamiento	
F	87-91	SUBURBAN 1/2 TON, V1500 Todos Suspensión Quad Amortiguador Corto; Exc. Kit de Levantamiento	
F	81-86	SUBURBAN 3/4 TON, K25 / K2500 Todos Suspensión Quad Amortiguador Corto; Exc. Kit de Levantamiento	
F	87-91	SUBURBAN 3/4 TON, V2500 Todos Suspensión Quad Amortiguador Corto; Exc. Kit de Levantamiento	
<b>G63909</b>	B	141368	
F	02-07	<b>DODGE</b> H100	
F	81-95	<b>ISUZU</b> PICKUP 4x4	
F	98-04	<b>NISSAN</b> FRONTIER 4x2 Tracción trasera Exc. Desert Runner	
F	95-97	PICKUP 4x2 Tracción trasera	
F	65-93	PICKUP	
<b>G63918</b>	D		
R	03-06	<b>DODGE</b> SPRINTER 2500 Todos Exc. Doble Rodada Trasera	
R	03-06	SPRINTER 3500 Todos Exc. Doble Rodada Trasera	
R	04-06	<b>MERCEDES-BENZ</b> SPRINTER Todos Exc. Doble Rodada Trasera	
<b>G63919</b>	D		
R	03-06	<b>DODGE</b> SPRINTER 3500 Todos Doble Rodada Trasera	
R	04-06	<b>MERCEDES-BENZ</b> SPRINTER Todos Doble Rodada Trasera	
<b>G63928</b>	D		
R	81-95	<b>ISUZU</b> PICKUP 4x4	
R	68-75	<b>JEEP</b> CJ7	
<b>G63929</b>	C	140780	
F	92-07	<b>FORD</b> VAN 1/2 TON, ECONOLINE / CLUB WAGON Todos	
<b>G63937</b>	C	140673	
F	01-04	<b>TOYOTA</b> TACOMA S-Runner	
F	04	TACOMA Base, 4x2 Tracción trasera	
F	95-03	TACOMA DLX, 4x2 Tracción trasera	
<b>G63949</b>	D		
R	02-07	<b>DODGE</b> H100	
<b>G63950</b>	D	140455	
F	83-93	<b>DODGE</b> PICKUP, RAM 50 4x2 Tracción trasera	

Lista numérica

Amort.	POP	No. Alternativo	Montaje Accesorio
Pos.	Año	Aplicación	
<b>G63958</b>	A	143276	
F	06-08	<b>DODGE</b> PICKUP 1/2 TON, RAM 1500 Crew Cab Pickup, 4x2 Tracción trasera	
F	06-08	PICKUP 1/2 TON, RAM 1500 Standard Cab Pickup, 4x2 Tracción trasera	
F	02-05	PICKUP 1/2 TON, RAM 1500 4x2 Tracción trasera	
<b>G63959</b>	A		
R	07-14	<b>CHEVROLET</b> CHEYENNE	
R	14	PICKUP 1/2 TON, SILVERADO 1500 Todos Exc. Modelos Classic y Suspensión Electrónica Ajustable	
R	08-13	PICKUP 1/2 TON, SILVERADO 1500 Todos Exc. Suspensión Electrónica Ajustable	
R	07	PICKUP 1/2 TON, SILVERADO 1500 Base Exc. Suspensión Electrónica Ajustable	
R	07	PICKUP 1/2 TON, SILVERADO 1500 LS Exc. Suspensión Electrónica Ajustable	
R	07	PICKUP 1/2 TON, SILVERADO 1500 LT Exc. Suspensión Electrónica Ajustable	
R	07	PICKUP 1/2 TON, SILVERADO 1500 LTZ Exc. Suspensión Electrónica Ajustable	
R	07	PICKUP 1/2 TON, SILVERADO 1500 WT Exc. Suspensión Electrónica Ajustable	
R	14	<b>GMC</b> SIERRA 1500 Todos Exc. Modelos Classic y Suspensión Electrónica Ajustable	
R	08-13	SIERRA 1500 Todos Exc. Suspensión Electrónica Ajustable	
R	07	SIERRA 1500 SLE Exc. Suspensión Electrónica Ajustable	
R	07	SIERRA 1500 SLT Exc. Suspensión Electrónica Ajustable	
R	07	SIERRA 1500 WT Exc. Suspensión Electrónica Ajustable	
<b>G63961</b>	C		
R	06-08	<b>DODGE</b> PICKUP 1/2 TON, RAM 1500 4x4 Exc. Mega Cab	
<b>G63962</b>	D		
R	06-08	<b>DODGE</b> PICKUP 1/2 TON, RAM 1500 4x2 Tracción trasera Exc. Mega Cab	
<b>G63963</b>	D		
R	05-06	<b>FORD</b> PICKUP, F-450 SUPERDUTY Todos	
R	05-06	PICKUP, F-550 SUPERDUTY Todos	
<b>G63964</b>	W		
R	05-06	<b>FORD</b> PICKUP 1 TON, F-350 / SUPERDUTY Cab & Chassis, 4x4	
<b>G63965</b>	D		
R	02-07	<b>DODGE</b> H-100 DIESEL	
R	06-10	<b>HUMMER</b> H3 Todos	
<b>G63966</b>	C		
R	13	<b>JEEP</b> WRANGLER Todos	
R	07-12	WRANGLER Todos Exc. Ruedas de 17"	
<b>G63967</b>	D		
R	07-12	<b>JEEP</b> WRANGLER Todos Ruedas de 17"	
<b>G63969</b>	B	143146	
F	05-08	<b>FORD</b> PICKUP, F-450 SUPERDUTY Todos	
F	05-07	PICKUP, F-550 SUPERDUTY Todos	
<b>G63970</b>	C		
R	03-10	<b>DODGE</b> PICKUP 1 TON, RAM 3500 Standard Cab Pickup, 4x2 Tracción trasera	
R	03-10	PICKUP 3/4 TON, RAM 2500 Standard Cab Pickup, 4x2 Tracción trasera	
R	11-13	<b>RAM</b> 2500 (SEE DODGE RAM 2500) Standard Cab Pickup, 4x2 Tracción trasera	
<b>G63971</b>	C		
R	03-07	<b>DODGE</b> PICKUP 1 TON, RAM 3500 Crew Cab Pickup, 4x2 Tracción trasera	

Lista numérica

Amortiguadores para Camioneta Ultra, Amortiguadores Ultra,  
Amortiguadores Guardian Hidráulicos Reforzados

Lista numérica

Amort.	POP	No. Alternativo	Montaje Accesorio
Pos.	Año	Aplicación	
G63971	C	-continued	
R	03-06	PICKUP 3/4 TON, RAM 2500 Crew Cab Pickup, 4x2 Tracción trasera	
G64000	D		
R	03-06	HUMMER H2 Todos	
G64001	D	143276	
F	02-07	DODGE H-100 DIESEL	
F	06-10	HUMMER H3 Todos	
G64002	W		
R	98-02	LINCOLN NAVIGATOR 4x4, Air (RearSpringType)	
G64004	D	141041	
R	05-11	TOYOTA TACOMA X-Runner Izquierdo	
G64005	D	141041	
R	05-11	TOYOTA TACOMA X-Runner Derecho	
G64006	D	141041	
R	05-11	TOYOTA TACOMA 4x4	
G64007	D	141041	
R	05-11	TOYOTA TACOMA Pre Runner	
G64008	C	142973	
F	07-13	JEEP WRANGLER Todos	
G64009	D	142731	
F	06-08	DODGE PICKUP 1/2 TON, RAM 1500 4x4 Mega Cab	
G64010	B		
R	05-12	FORD PICKUP 1 TON, F-350 / SUPERDUTY 4x2 Tracción trasera	
R	05-13	PICKUP 3/4 TON, F-250 / SUPERDUTY 4x2 Tracción trasera	
G64011	C	142731	
F	05-08	DODGE PICKUP 3/4 TON, RAM 2500 4x4	
G64012	C		
R	06-10	JEEP COMMANDER Todos	
R	05-10	GRAND CHEROKEE Todos	
G64013	C		
R	03-10	DODGE PICKUP 3/4 TON, RAM 2500 4x4 PBV 8800	
R	11-12	RAM 2500	
R	13	RAM 2500 (SEE DODGE RAM 2500) 4x4	
R	11-12	2500 (SEE DODGE RAM 2500) 4x4 PBV 8800	
G64014	C		
R	06-09	CHEVROLET TRAILBLAZER Air (RearSpringType)	
R	02-05	TRAILBLAZER Todos Suspensión de Resorte de Aire Trasera	
R	03-06	GMC ENVOY Air (RearSpringType)	
G64029	W	142731	
R	07-12	TOYOTA FJ CRUISER 4x2 Tracción trasera	
G64030	W	142731	
R	11-12	TOYOTA FJ CRUISER 4x4	
R	07-09	FJ CRUISER 4x4	
G64031	C		
R	09-13	NISSAN FRONTIER Todos Exc. Nismo Off-Road	
R	05-08	FRONTIER LE	
R	05-08	FRONTIER SE	
R	05-08	FRONTIER XE	
G64038	D	143340	
R	07-13	TOYOTA TUNDRA Todos	
G64043	A		
F	09-10	DODGE PICKUP 1/2 TON, RAM 1500 4x2 Tracción trasera	
F	11-14	RAM 1500	
F	11-14	RAM 1500 (SEE DODGE RAM 1500) 4x2 Tracción trasera	
G64044	C		
R	09-10	DODGE PICKUP 1/2 TON, RAM 1500 Todos	
R	11-14	RAM 1500	
R	11-14	RAM 1500 (SEE DODGE RAM 1500) Todos	

Amort.	POP	No. Alternativo	Montaje Accesorio
Pos.	Año	Aplicación	
G64047	C		
R	08-11	FORD ESCAPE Todos	
G64061	D		
R	07-11	RENAULT TRAFIC	
G64063	N		
R	07-12	FORD TRANSIT	
G64079	C		
R	09-14	FORD PICKUP 1/2 TON, F-150 4x4	
R	09-12	LINCOLN MARK LT	
G64089	N		
R	07-12	MERCEDES-BENZ SPRINTER 415 & 515	
R	10-11	VOLKSWAGEN CRAFTER VAN	
G64090	FF		
R	05-12	VOLKSWAGEN EUROVAN	
R	10-13	TRANSPORTER Todos	
G64091	N		
R	07-12	MERCEDES-BENZ SPRINTER 315	
R	07-10	VW CRAFTER	
R	08-13	VOLKSWAGEN CRAFTER VAN	
G64101	N		
R	12-14	CHEVROLET SUBURBAN 1/2 TON, 1500 Todos	
R	12-14	TAHOE Todos	
R	12-14	GMC YUKON Todos	
R	12-14	YUKON XL 1/2 TON Todos	
G64128	FF		
R	08-13	DODGE H-100 DIESEL	
G64129	FF		
F	08-13	DODGE H-100 DIESEL	
G64131	FF		
R	12-14	FORD RANGER Todos	

Amortiguadores Ultra

69574	D	140505	
R	03-10	FORD CROWN VICTORIA Police Interceptor Modelos Policía y Taxi	
69575	D	140505	
R	10-11	FORD CROWN VICTORIA Base Exc. Modelos Policía y Taxi	
R	03-11	CROWN VICTORIA LX Exc. Modelos Policía y Taxi	
R	03-08	CROWN VICTORIA Base Exc. Modelos Policía y Taxi	
R	04-06	CROWN VICTORIA LX Sport Exc. Modelos Policía y Taxi	
R	05	CROWN VICTORIA S Exc. Modelos Policía y Taxi	
R	05	CROWN VICTORIA Special Edition Exc. Modelos Policía y Taxi	
R	03	CROWN VICTORIA LWB Exc. Modelos Policía y Taxi	
R	03	CROWN VICTORIA S Exc. Modelos Policía y Taxi	
69581	D	143170	
F	00-04	VOLKSWAGEN EUROVAN	
69582	D	143175	
R	00-04	VOLKSWAGEN EUROVAN	
69604	W	140629	
R	71-82	CHEVROLET IMPALA Wagon	
69606	B	141150	
R	92-02	FORD CROWN VICTORIA Todos	
R	87-91	LTD / COUNTRY SEDAN / COUNTRY SQUIRE / CROWN VICTORIA Todos	
69675	C	141041	
F	92-96	CADILLAC COMMERCIAL CHASSIS 4x2 Tracción trasera	
F	77-84	COMMERCIAL CHASSIS Todos	
F	94-96	CHEVROLET IMPALA Todos	
F	83-85	IMPALA Todos	
F	82	IMPALA Sedan	
F	65-81	IMPALA Todos	
F	92-02	FORD CROWN VICTORIA Todos	
F	87-91	LTD / COUNTRY SEDAN / COUNTRY SQUIRE / CROWN VICTORIA Todos	
69703	W	140873	
R	77-78	DODGE CHARGER Todos	

Amort.	POP	No. Alternativo	Montaje Accesorio
Pos.	Año	Aplicación	
69724	W	140629	
R	92-96	CADILLAC COMMERCIAL CHASSIS 4x2 Tracción trasera	
R	77-84	COMMERCIAL CHASSIS Todos	
R	94-96	CHEVROLET IMPALA Todos	
R	83-85	IMPALA Todos	
R	71-82	IMPALA Sedan	
R	74-81	IMPALA Coupe	
R	73	IMPALA Hardtop	
R	65-70	IMPALA Todos	
69807	W		
R	95	MERCEDES-BENZ E300 Todos	
R	94	E500 Todos	
69858	W		
R	80-91	VOLKSWAGEN VANAGON 4x2 Tracción trasera	
69861	W	141191	
F	80-91	VOLKSWAGEN VANAGON 4x2 Tracción trasera	
69881	W	140857	
R	79-81	NISSAN F10	
69900	C	140455	
R	01-08	FORD ESCAPE Todos	
69952	W		
F	96-99	MERCEDES-BENZ E300 Todos Exc. Suspensión Deportiva	
69966	W		
R	99	MERCEDES-BENZ E300 Todos Exc. 4 Matic	
R	96-98	E300 Todos	
70002	C		
R	03-12	RENAULT KANGOO	
70009	D		
R	03-12	PEUGEOT GRAND RAID	
R	03-09	PARTNER Todos	
<b>Amortiguadores Guardian Hidráulicos Reforzados</b>			
70161	A	140857	
F	81-95	ISUZU PICKUP	
F	05-12	NISSAN PICKUP	
F	95-04	PICKUP Todos	
F	65-94	PICKUP	
70163	A		
R	83-93	DODGE RAM 50	
R	86-87	MAZDA B2000	
R	87-93	B2200	
R	87-93	B2600	
R	87-90	MITSUBISHI VAN	
R	98-04	NISSAN FRONTIER 4x2 Tracción trasera Exc. Desert Runner	
R	05-12	PICKUP	
R	95-04	PICKUP Todos	
R	84-94	PICKUP	
R	85-95	TOYOTA PICKUP	
R	84	PICKUP 4x2 Tracción trasera	
R	70-83	PICKUP Todos 4x2 Tracción trasera; Mojave	
R	84-88	VAN	
R	88	VAN WAGON	
70164	B	140702	
F	87-91	CHEVROLET C10	
F	73-91	C10 SUBURBAN	
F	73-91	C15	
F	73-91	C25	
F	63-91	C30	
F	73-91	C35	
F	73-91	C1500	
F	73-91	C2500	
F	73-91	C3500	
F	63-72	P20	
F	63-91	P30	
F	79-86	PICKUP 1/2 TON, C10 Todos	
F	63-74	PICKUP 1/2 TON, C10 Todos	
F	63-74	PICKUP 3/4 TON, C20 Todos	
F	63-72	VAN 1/2 TON, P SERIES Todos	
70165	C	140357	
R	73-91	CHEVROLET BLAZER	
R	73-91	C10 SUBURBAN	
R	73-91	C15	
R	73-91	C25	
R	73-91	C1500	
R	73-91	C2500	

## Lista numérica

## Lista numérica

Amort.	POP	No. Alternativo	Montaje Accesorio
Pos.	Año	Aplicación	

**70166** D  
F 72-93 **DODGE** D100  
F 72-93 D150  
F 72-93 D250  
F 81-93 D350  
F 99-03 RAM VAN 1500, 2500 Y 3500  
F 97-01 RAM WAGON Y VAN

**70167** W  
R 73-93 **DODGE** D100  
R 72-93 D150  
R 72-93 D250  
R 72-93 D350  
R 95-96 RAMCHARGER  
R 88-90 RAMCHARGER  
R 97-01 RAM WAGON Y VAN

**70168** W  
F 75-91 **FORD** E-100 ECONOLINE  
F 75-91 E-150 ECONOLINE

**70169** C  
F 85-91 **FORD** E-250 ECONOLINE  
F 85-91 E-350 ECONOLINE  
F 72-79 F-150  
F 72-79 F-250  
F 67-97 F-350 PICKUP

**70170** W  
R 75-91 **FORD** E-100 ECONOLINE  
R 75-91 E-150 ECONOLINE

**70171** C  
F 83-05 **CHEVROLET** S10 BLAZER  
F 83-05 **GMC** S15 JIMMY

**70172** W  
R 67-79 **FORD** F-350 PICKUP  
R 84-91 **JEEP** GRAND WAGONEER  
R 74-88 J20  
R 84-91 PICKUP

**70173** C  
R 83-05 **CHEVROLET** S10 BLAZER  
R 83-05 **GMC** S15 JIMMY

**70175** W  
R 61-72 **DODGE** D100  
R 74 M300  
F 86-89 PICKUP 1/2 TON, W100 SERIES  
F 61-74 PICKUP 1/2 TON, W100 SERIES  
F 61-80 PICKUP 1 TON, W300 SERIES  
R 61-71 PICKUP 1 TON, W300 SERIES  
R 61-71 PICKUP 3/4 TON, D200 SERIES  
F 81-93 PICKUP 3/4 TON, W200 SERIES  
F 69-74 PICKUP 3/4 TON, W200 SERIES  
F 61-67 PICKUP 3/4 TON, W200 SERIES  
F 74 RAMCHARGER  
F 75-93 RAMCHARGER 4x4  
F 75-77 W100  
F 77-93 W150  
F 75-80 W200  
F 81-93 W350  
F 74-81 **PLYMOUTH** TRAILDUSTER

**70176** W  
F 72-80 **DODGE** B300  
F 81-93 B350  
F 70-80 CB-300  
F 72-80 D200 HEAVY DUTY  
F 72-93 D250 HEAVY DUTY  
F 81-93 D350  
F 81-93 MB-300  
F 81-93 MB-350  
F 70-80 MB-400  
F 74-80 PB300 VAN  
F 81-83 PB350 VAN

**Amortiguador Monotubo MaxControl**

**77183** W  
F 81-93 **DODGE** PICKUP 1/2 TON, W100  
F 61-80 PICKUP 1/2 TON, W100 SERIES  
F 61-80 PICKUP 1/2 TON, W100 SERIES  
F 61-80 PICKUP 1/2 TON, W100 SERIES

Amort.	POP	No. Alternativo	Montaje Accesorio
Pos.	Año	Aplicación	

**77183** W -continued  
F 81-93 PICKUP 1 TON, W300 SERIES  
F 72-80 PICKUP 1 TON, W300 SERIES  
R 64-71 PICKUP 1 TON, W300 SERIES  
F 61-67 PICKUP 1 TON, W300 SERIES  
F 81-93 PICKUP 3/4 TON, W200 SERIES  
F 69-80 PICKUP 3/4 TON, W200 SERIES  
F 61-67 PICKUP 3/4 TON, W200 SERIES

**77349** W **140357**

R 87-91 **CHEVROLET** BLAZER Todos  
R 73-86 BLAZER Todos Exc. Kit de  
R 73-86 PICKUP 1/2 TON, C10 Todos  
R 73-86 PICKUP 1/2 TON, K10 Todos Exc.  
R 87 PICKUP 1/2 TON, R10 Todos  
R 87 PICKUP 1/2 TON, V10 Todos Exc.  
R 73-74 PICKUP 3/4 TON, C20 Todos  
R 73-86 PICKUP 3/4 TON, K20 Todos Exc.  
R 87 PICKUP 3/4 TON, R20 Standard  
R 87 PICKUP 3/4 TON, V20 Todos Exc.  
R 73-86 SUBURBAN 1/2 TON, C10 Todos  
R 73-86 SUBURBAN 1/2 TON, K10 Todos  
R 87-88 SUBURBAN 1/2 TON, R10 Todos  
R 89-91 SUBURBAN 1/2 TON, R1500 Todos  
R 89-91 SUBURBAN 1/2 TON, V1500 Todos  
R 73-86 SUBURBAN 3/4 TON, C20 Todos  
R 73-86 SUBURBAN 3/4 TON, K20 Todos  
R 87-88 SUBURBAN 3/4 TON, R20 Todos  
R 89-91 SUBURBAN 3/4 TON, R2500 Todos  
R 87-88 SUBURBAN 3/4 TON, V20 Todos  
R 89-91 SUBURBAN 3/4 TON, V2500 Todos  
R 73 VAN 1/2 TON, P SERIES Todos  
R 73-78 VAN 3/4 TON, P SERIES Todos  
R 73-91 **GMC** JIMMY Todos Exc. Kit de  
R 73-86 PICKUP 1/2 TON, C15 / C1500  
R 73-86 PICKUP 1/2 TON, K15 / K1500  
R 87 PICKUP 1/2 TON, R1500 Todos  
R 87 PICKUP 1/2 TON, V1500 Todos  
R 75-86 PICKUP 3/4 TON, C25 / C2500 Cab  
R 75-86 PICKUP 3/4 TON, C25 / C2500  
R 73-74 PICKUP 3/4 TON, C25 / C2500  
R 73-86 PICKUP 3/4 TON, K25 / K2500  
R 88-89 PICKUP 3/4 TON, R2500 Todos  
R 87 PICKUP 3/4 TON, R2500 Cab & Chassis  
R 87 PICKUP 3/4 TON, R2500 Standard  
R 87 PICKUP 3/4 TON, V2500 Todos  
R 73-86 SUBURBAN 1/2 TON, C15 / C1500

Amort.	POP	No. Alternativo	Montaje Accesorio
Pos.	Año	Aplicación	

**77349** W -continued **140357**  
R 73-86 SUBURBAN 1/2 TON, K15 / K1500  
R 87-91 SUBURBAN 1/2 TON, V1500 Todos  
R 87-91 SUBURBAN 1/2 TON, V1500 Todos  
R 75-86 SUBURBAN 3/4 TON, C25 / C2500  
R 73-74 SUBURBAN 3/4 TON, C25 / C2500  
R 73-86 SUBURBAN 3/4 TON, K25 / K2500  
R 87-91 SUBURBAN 3/4 TON, R2500 Todos  
R 87-91 SUBURBAN 3/4 TON, V2500 Todos  
R 73 VAN 1/2 TON, P SERIES Todos  
R 73-78 VAN 3/4 TON, P SERIES Todos

**77355** W **140702**

F 69-84 **CHEVROLET** BLAZER 4x2 Tracción trasera  
F 63-86 PICKUP 1/2 TON, C10 Todos  
F 87 PICKUP 1/2 TON, R10 Todos  
F 63-86 PICKUP 1 TON, C30 Todos  
F 88-91 PICKUP 1 TON, C35/3500 Cab & Chassis  
F 87-88 PICKUP 1 TON, R30 Todos  
F 89 PICKUP 1 TON, R3500 Standard Cab Pickup  
F 63-74 PICKUP 3/4 TON, C20 Todos  
F 88 PICKUP 3/4 TON, R20 Todos  
F 87 PICKUP 3/4 TON, R20 Crew Cab Pickup  
F 89 PICKUP 3/4 TON, R2500 Todos  
F 63-67 SUBURBAN 3/4 TON, 1500 Todos  
F 63-86 SUBURBAN 1/2 TON, C10 Todos  
F 68-86 SUBURBAN 1/2 TON, K10 Todos  
F 87-88 SUBURBAN 1/2 TON, R10 Todos  
F 89-91 SUBURBAN 1/2 TON, R1500 Todos  
F 68-86 SUBURBAN 3/4 TON, C20 Todos  
F 68-86 SUBURBAN 3/4 TON, K20 Todos  
F 87-88 SUBURBAN 3/4 TON, R20 Todos  
F 89-91 SUBURBAN 3/4 TON, R2500 Todos  
F 63-80 VAN 1/2 TON, P SERIES Todos  
F 68-89 VAN 3/4 TON, P SERIES Todos  
F 75-84 **GMC** JIMMY 4x2 Tracción trasera  
F 70-74 JIMMY Todos 4x2 Tracción trasera  
F 67-86 PICKUP 1/2 TON, C15 / C1500  
F 87 PICKUP 1/2 TON, R1500 Todos  
F 88-91 PICKUP 1 TON, C35/3500 Cab & Chassis  
F 67-78 PICKUP 1 TON, C35/3500 Todos  
F 87-91 PICKUP 1 TON, R3500 Todos  
F 85-86 PICKUP 3/4 TON, C25 / C2500  
F 75-86 PICKUP 3/4 TON, C25 / C2500 Cab & Chassis  
F 75-86 PICKUP 3/4 TON, C25 / C2500 Standard Cab Pickup  
F 75-83 PICKUP 3/4 TON, C25 / C2500  
F 67-74 PICKUP 3/4 TON, C25 / C2500  
F 87-89 PICKUP 3/4 TON, R2500 Todos  
F 63-65 PICKUP 1500 SERIES Todos  
F 68-86 SUBURBAN 1/2 TON, C15 / C1500  
F 87-91 SUBURBAN 1/2 TON, R1500 Todos  
F 68-86 SUBURBAN 3/4 TON, C25 / C2500  
F 87-91 SUBURBAN 3/4 TON, R2500 Todos  
F 67-80 VAN 1/2 TON, P SERIES Todos  
F 75-90 VAN 1 TON, P SERIES Todos  
F 73-74 VAN 1 TON, P SERIES Base Exc.  
F 68-72 VAN 1 TON, P SERIES Todos  
F 68-89 VAN 3/4 TON, P SERIES Todos  
F 63-65 VAN, PB 1000 SERIES Todos

**77357** W  
F 71-95 **CHEVROLET** VAN 1/2 TON, G / EXPRESS Todos  
F 70 VAN 1/2 TON, G / EXPRESS Todos  
F 78-95 VAN 1 TON, G / EXPRESS Todos  
F 75 VAN 1 TON, G / EXPRESS 146.0 (WheelBase)  
F 71-74 VAN 1 TON, G / EXPRESS Todos  
F 78-95 VAN 3/4 TON, G / EXPRESS Todos

Lista numérica

Amort.	POP	No. Alternativo	Montaje Accesorio
Pos.	Año	Aplicación	
<b>77357</b>	W	-continued	
F	71-77	VAN 3/4 TON, G / EXPRESS Todos	
F	70	VAN 3/4 TON, G / EXPRESS Todos Suspensión Delantera Independiente	
F	71-95	<b>GMC</b> VAN 1/2 TON, G / SAVANNA Todos	
F	70	VAN 1/2 TON, G / SAVANNA Todos Suspensión Delantera Independiente	
F	71-95	VAN 1 TON, G / SAVANNA Todos	
F	78-95	VAN 3/4 TON, G / SAVANNA Todos Exc. PBV 8600 #	
F	71-77	VAN 3/4 TON, G / SAVANNA Todos	
F	70	VAN 3/4 TON, G / SAVANNA Todos Suspensión Delantera Independiente	
<b>77359</b>	W	140126	
F	72-93	<b>DODGE</b> PICKUP 1/2 TON, D100 SERIES Todos	
F	90-93	PICKUP 3/4 TON, D200 SERIES Todos Exc. Paquete HD	
F	82-89	PICKUP 3/4 TON, D200 SERIES Todos	
F	72-81	PICKUP 3/4 TON, D200 SERIES Todos Exc. Paquete HD	
F	75-93	RAMCHARGER 4x2 Tracción trasera	
F	99-03	VAN 1/2 TON, A / B SERIES / RAM 109.3 (WheelBase) Exc. PBV 7000#	
F	81-98	VAN 1/2 TON, A / B SERIES / RAM 109.6 (WheelBase) Exc. PBV 7000#	
F	71-80	VAN 1/2 TON, A / B SERIES / RAM Todos	
F	99-03	VAN 1 TON, A / B SERIES / RAM Todos	
F	71-98	VAN 1 TON, A / B SERIES / RAM Todos Exc. Eje Delantero 4000#	
F	71-03	VAN 3/4 TON, A / B SERIES / RAM Todos	
F	74-80	VAN, CB300 Todos Exc. Eje Delantero 4000#	
F	81	<b>PLYMOUTH</b> TRAILDUSTER Todos	
F	75-80	TRAILDUSTER 4x2 Tracción trasera	
F	74-83	VAN 1/2 TON, PB SERIES Todos	
F	74-83	VAN 1 TON, PB SERIES Todos Exc. Eje Delantero 4000#	
F	74-83	VAN 3/4 TON, PB SERIES Todos	
<b>77375</b>	W	140780	
F	85-05	<b>CHEVROLET</b> ASTRO 4x2 Tracción trasera	
F	71-85	IMPALA Sedan Modelos Policía y Taxi	
F	96-02	VAN 1/2 TON, G / EXPRESS Todos	
F	97-02	VAN 1 TON, G / EXPRESS Todos	
F	96	VAN 1 TON, G / EXPRESS Todos Exc. PBV 8600 #	
F	96-02	VAN 3/4 TON, G / EXPRESS Todos Exc. PBV 8600 #	
F	93-02	<b>FORD</b> CROWN VICTORIA Police Interceptor Modelos Policía y Taxi	
F	85-05	<b>GMC</b> SAFARI 4x2 Tracción trasera	
F	96-02	VAN 1/2 TON, G / SAVANNA 4x2 Tracción trasera	
F	96-02	VAN 1 TON, G / SAVANNA Todos	
F	96-02	VAN 3/4 TON, G / SAVANNA Todos Exc. PBV 8600 #	
<b>77377</b>	W	141137	
R	78-79	<b>FORD</b> BRONCO Todos Exc. Kit de Levantamiento	
R	66-77	BRONCO Todos Desde Serie #830001; Exc. Kit de Levantamiento	
R	66-69	PICKUP 1/2 TON, F-100 4x2 Tracción trasera	
R	65	PICKUP 1/2 TON, F-100 Todos 4x2 Tracción trasera	
R	75-79	PICKUP 1 TON, F-350 / SUPERDUTY Standard Cab Pickup, 4x2 Tracción trasera	
R	73-74	PICKUP 1 TON, F-350 / SUPERDUTY Todos	
R	73-79	PICKUP 3/4 TON, F-250 / SUPERDUTY 4x2 Tracción trasera	
R	65-72	PICKUP 3/4 TON, F-250 / SUPERDUTY Todos 4x2 Tracción trasera	
R	69-74	VAN 1/2 TON, ECONOLINE / CLUB WAGON Todos	
R	68	VAN 1/2 TON, ECONOLINE / CLUB WAGON Todos A finales de 1968	
R	69-74	VAN 1 TON, ECONOLINE / CLUB WAGON / SUPERDUTY Todos	
R	68	VAN 1 TON, ECONOLINE / CLUB WAGON / SUPERDUTY Todos A finales de 1968	

Amortiguador Monotubo MaxControl

Amort.	POP	No. Alternativo	Montaje Accesorio
Pos.	Año	Aplicación	
<b>77377</b>	W	-continued 141137	
R	69-74	VAN 3/4 TON, ECONOLINE / CLUB WAGON / SUPERDUTY Todos	
R	68	VAN 3/4 TON, ECONOLINE / CLUB WAGON / SUPERDUTY Todos A finales de 1968	
R	76-83	<b>JEEP</b> CHEROKEE Todos	
F	74-83	CHEROKEE Todos	
F	82-83	CJ5 Todos Exc. Kit de Levantamiento	
F	82-86	CJ7 Todos Exc. Kit de Levantamiento	
F	84-91	GRAND WAGONEER Todos	
R	84-91	GRAND WAGONEER Todos	
F	74-88	J10 PICKUP Todos	
R	74-88	J10 PICKUP Todos	
F	74-88	J20 PICKUP Todos	
R	74-88	J20 PICKUP Todos	
F	82-85	SCRAMBLER / CJ8 Todos	
R	76-83	WAGONEER Todos	
F	74-83	WAGONEER Todos	
<b>77389</b>	W		
R	81-93	<b>DODGE</b> PICKUP 1/2 TON, W100 SERIES Todos Exc. Kit de Levantamiento	
R	72-80	PICKUP 1/2 TON, W100 SERIES Todos	
R	81-93	PICKUP 1 TON, W300 SERIES Todos Exc. Suspensión Quad y Kit de Levantamiento	
R	72-80	PICKUP 1 TON, W300 SERIES Todos	
R	81-93	PICKUP 3/4 TON, W200 SERIES Standard Cab Pickup Exc. Kit de Levantamiento	
R	72-80	PICKUP 3/4 TON, W200 SERIES Todos	
R	76-81	<b>PLYMOUTH</b> TRAILDUSTER 4x4	
<b>77403</b>	W		
R	79-95	<b>CHEVROLET</b> VAN 1 TON, G / EXPRESS Todos PBV 9200	
R	79-95	<b>GMC</b> VAN 1 TON, G / SAVANNA Cutaway Van PBV 9200	
F	85	VAN 1 TON, P SERIES Todos Chasis Motorhome c/ Eje de Vega Delantero en I	
<b>77405</b>	W	140884	
R	55	<b>FORD</b> F SERIES Todos F-100	
F	48-52	F SERIES Todos F-1, F-2 & F-3	
R	61-64	PICKUP 1/2 TON, F-100 Todos	
R	61-66	PICKUP 1 TON, F-350 / SUPERDUTY Todos	
R	61-64	PICKUP 3/4 TON, F-250 / SUPERDUTY Todos	
F	68-76	PICKUP P350 Todos Hasta PBV 8000#	
F	75-76	PICKUP P400 Todos Hasta PBV 8000#	
R	68	<b>INTERNATIONAL</b> 908B Todos	
R	68	908C Todos	
R	68	1000B Todos	
R	68	1000C Todos Exc. Travelette c/ base de rueda de 166"	
F	68	1100B Todos Exc. Travelette c/ base de rueda de 166"	
R	68	1100B Todos Exc. Travelette c/ base de rueda de 166"	
F	68	1100C Todos Exc. Travelette c/ base de rueda de 166"	
R	68	1100C Todos Exc. Travelette c/ base de rueda de 166"	
F	68	1200B Todos Exc. Travelette c/ base de rueda de 166"	
R	68	1200B Todos Exc. Travelette c/ base de rueda de 166"	
F	68	1200C Todos Exc. Travelette c/ base de rueda de 166"	
R	68	1200C Todos Exc. Travelette c/ base de rueda de 166"	
F	68	1300B Todos Exc. Travelette c/ base de rueda de 166"	
R	68	1300B Todos Exc. Travelette c/ base de rueda de 166"	
F	68	1300C Todos Exc. Travelette c/ base de rueda de 166"	
R	68	1300C Todos Exc. Travelette c/ base de rueda de 166"	
R	68-72	M1100 / M1200 Todos	
R	69	M1400 Todos	
R	65-67	M SERIES VAN Todos	
R	66-83	<b>JEEP</b> CJ5 Todos Exc. Kit de Levantamiento	

Lista numérica

Amort.	POP	No. Alternativo	Montaje Accesorio
Pos.	Año	Aplicación	
<b>77405</b>	W	-continued 140884	
R	66-75	CJ6 Todos Exc. Kit de Levantamiento	
R	76-86	CJ7 Todos Exc. Kit de Levantamiento	
R	66-74	DJ5 Todos Exc. Kit de Levantamiento	
R	66-68	DJ6 Todos Exc. Kit de Levantamiento	
R	57-60	FC150 Todos	
F	63-65	FC170 Todos	
R	63-65	FC170 Todos	
R	63-66	GLADIATOR Todos Suspensión Delantera Independiente	
R	70-73	JEEPSTER Todos	
R	81-85	SCRAMBLER / CJ8 Todos	
R	66-67	UNIVERSAL Todos Exc. Kit de Levantamiento	
R	61-65	UNIVERSAL Todos	
<b>77406</b>	D		
R	85-96	<b>FORD</b> PICKUP 1/2 TON, F-150 4x2 Tracción trasera	
R	80-97	PICKUP 1 TON, F-350 / SUPERDUTY 4x2 Tracción trasera Exc. Doble Rodada Trasera	
R	97	PICKUP 3/4 TON, F-250 / SUPERDUTY 4x2 Tracción trasera PBV arriba de 8500#	
R	80-96	PICKUP 3/4 TON, F-250 / SUPERDUTY 4x2 Tracción trasera	
<b>77409</b>	W		
R	80-96	<b>FORD</b> BRONCO Todos Exc. Kit de Levantamiento	
R	80-83	PICKUP 1/2 TON, F-100 4x2 Tracción trasera	
R	80-84	PICKUP 1/2 TON, F-150 4x2 Tracción trasera	
R	90-97	PICKUP 1/2 TON, F SUPERDUTY Todos	
R	80-97	PICKUP 1 TON, F-350 / SUPERDUTY 4x2 Tracción trasera Doble Rodada Trasera	
R	97	PICKUP, F-450 SUPERDUTY Todos	
<b>77410</b>	W	141047	
F	80-96	<b>FORD</b> BRONCO Todos Suspensión Quad adelante del Eje Delantero; Exc. Kit de Levantamiento	
F	80-96	PICKUP 1/2 TON, F-150 4x4 Suspensión Quad adelante del Eje Delantero; Exc. Kit de Levantamiento	
F	80-81	PICKUP 1 TON, F-350 / SUPERDUTY 4x4	
F	80-82	PICKUP 3/4 TON, F-250 / SUPERDUTY 4x4	
<b>77412</b>	C		
R	03-07	<b>CHEVROLET</b> CHEYENNE	
R	07	PICKUP 1/2 TON, SILVERADO 1500 Classic Hybrid, 4x4 Classic y Old Body Style; Exc. Suspensión Electrónica Ajustable	
R	07	PICKUP 1/2 TON, SILVERADO 1500 Classic LS, 4x4 Classic y Old Body Style; Exc. Suspensión Electrónica Ajustable	
R	07	PICKUP 1/2 TON, SILVERADO 1500 Classic LT, 4x4 Classic y Old Body Style; Exc. Suspensión Electrónica Ajustable	
R	07	PICKUP 1/2 TON, SILVERADO 1500 Classic WT, 4x4 Classic y Old Body Style; Exc. Suspensión Electrónica Ajustable	
R	99-06	PICKUP 1/2 TON, SILVERADO 1500 4x4 Classic y Old Body Style; Exc. Suspensión Electrónica Ajustable	
R	05-07	PICKUP 1/2 TON, SILVERADO 1500 HD Todos	
R	01-03	PICKUP 1/2 TON, SILVERADO 1500 HD Todos	
R	77-86	PICKUP 1 TON, K30 Todos	
R	90-91	PICKUP 1 TON, R3500 Todos	
R	89	PICKUP 1 TON, R3500 Cab & Chassis, 4x2 Tracción trasera	
R	89	PICKUP 1 TON, R3500 Crew Cab Pickup, 4x2 Tracción trasera	
R	01-09	PICKUP 1 TON, SILVERADO 3500 Todos	
R	07-10	PICKUP 1 TON, SILVERADO 3500 HD Todos	
R	87-88	PICKUP 1 TON, V30 Todos	

## Lista numérica

Amort.	POP	No. Alternativo	Montaje Accesorio
Pos.	Año	Aplicación	
<b>77412</b>	C	-continued	
R	89-91	PICKUP 1 TON, V3000 / V3500 Todos	
R	99-08	PICKUP 3/4 TON, SILVERADO 2500 Todos	
R	01-10	PICKUP 3/4 TON, SILVERADO 2500 HD Todos	
R	06-07	<b>DODGE</b> PICKUP 1/2 TON, RAM 1500 Todos Exc. Mega Cab	
R	02-05	PICKUP 1/2 TON, RAM 1500 Todos	
R	77-86	<b>GMC</b> PICKUP 1 TON, K35 / K3500 Todos	
R	87-91	PICKUP 1 TON, V3000 / V3500 Todos	
R	07	SIERRA 1500 Classic Hybrid, 4x4 Classic y Old Body Style; Exc. Suspensión Electrónica Ajustable	
R	07	SIERRA 1500 Classic SL, 4x4 Classic y Old Body Style; Exc. Suspensión Electrónica Ajustable	
R	07	SIERRA 1500 Classic SLE, 4x4 Classic y Old Body Style; Exc. Suspensión Electrónica Ajustable	
R	07	SIERRA 1500 Classic SLT, 4x4 Classic y Old Body Style; Exc. Suspensión Electrónica Ajustable	
R	07	SIERRA 1500 Classic WT, 4x4 Classic y Old Body Style; Exc. Suspensión Electrónica Ajustable	
R	99-06	SIERRA 1500 4x4 Classic y Old Body Style; Exc. Suspensión Electrónica Ajustable	
R	05-07	SIERRA 1500 HD Todos	
R	01-03	SIERRA 1500 HD Todos	
R	99-04	SIERRA 2500 Todos	
R	01-10	SIERRA 2500 HD Todos	
R	01-07	SIERRA 3500 Todos	
R	07-10	SIERRA 3500 HD Todos	
<b>77413</b>	W	140780	
R	78-95	<b>CHEVROLET</b> VAN 1/2 TON, G / EXPRESS Todos	
R	85-91	VAN 1 TON, G / EXPRESS Extended Cargo Van	
R	85-91	VAN 1 TON, G / EXPRESS Extended Passenger Van	
R	78-91	VAN 1 TON, G / EXPRESS Standard Cargo Van	
R	78-91	VAN 1 TON, G / EXPRESS Standard Passenger Van	
R	78-95	VAN 3/4 TON, G / EXPRESS Todos Exc. PBV 8600 #	
R	99-03	<b>DODGE</b> VAN 1/2 TON, A / B SERIES / RAM 109.3 (WheelBase) Exc. PBV 7000#	
R	81-98	VAN 1/2 TON, A / B SERIES / RAM 109.6 (WheelBase) Exc. PBV 7000#	
R	71-80	VAN 1/2 TON, A / B SERIES / RAM Todos	
R	99-03	VAN 1 TON, A / B SERIES / RAM Todos	
R	94-98	VAN 1 TON, A / B SERIES / RAM Todos Exc. Eje Delantero 4000#	
R	71-93	VAN 1 TON, A / B SERIES / RAM Todos	
R	71-03	VAN 3/4 TON, A / B SERIES / RAM Todos	
R	74-80	VAN, CB300 Todos PBV arriba de 8300#	
R	78-95	<b>GMC</b> VAN 1/2 TON, G / SAVANNA Todos	
R	78-95	VAN 3/4 TON, G / SAVANNA Todos Exc. PBV 8600 #	
R	74-83	<b>PLYMOUTH</b> VAN 1/2 TON, PB SERIES Todos	
R	74-83	VAN 1 TON, PB SERIES Todos	
R	74-83	VAN 3/4 TON, PB SERIES Todos	
<b>77414</b>	W	140780	
F	80-96	<b>FORD</b> BRONCO Todos Con o sin Suspensión Quad detrás del Eje Delantero; Exc. Kit de Levantamiento	
F	89	BRONCO II Todos Fab. desde 2/89; Vehículos con perno de 12mm en montaje inferior trasero	
F	84-88	BRONCO II Todos Con Perno de 10mm en Montaje Inferior Trasero	
F	80-83	PICKUP 1/2 TON, F-100 4x2 Tracción trasera	
F	80-96	PICKUP 1/2 TON, F-150 4x4 Con o sin Suspensión Quad detrás del Eje Delantero; Exc. Kit de Levantamiento	

## Amortiguador Monotubo MaxControl

Amort.	POP	No. Alternativo	Montaje Accesorio
Pos.	Año	Aplicación	
<b>77414</b>	W	-continued 140780	
F	80-96	PICKUP 1/2 TON, F-150 4x2 Tracción trasera	
F	80-97	PICKUP 1 TON, F-350 / SUPERDUTY 4x2 Tracción trasera	
F	97	PICKUP 3/4 TON, F-250 / SUPERDUTY 4x2 Tracción trasera PBV arriba de 8500#	
F	80-96	PICKUP 3/4 TON, F-250 / SUPERDUTY 4x2 Tracción trasera	
F	87-89	RANGER Todos Exc. Opción High Ryder	
F	83-86	RANGER Todos	
<b>77418</b>	W	141356	
F	87-93	<b>DODGE</b> PICKUP, RAM 50 4x4	
F	87-89	RAIDER Todos	
<b>77421</b>	W	140455	
F	05	<b>CHEVROLET</b> BLAZER Base, 4x2 Tracción trasera	
F	96-04	BLAZER LS, 4x2 Tracción trasera	
F	95-02	BLAZER LT, 4x2 Tracción trasera	
F	95-99	BLAZER Base, 4x2 Tracción trasera	
F	95-97	BLAZER Deluxe, 4x2 Tracción trasera	
F	83-94	BLAZER, S MODELS 4x2 Tracción trasera	
F	94-03	S10 LS, 4x2 Tracción trasera	
F	82-03	S10 Base, 4x2 Tracción trasera	
F	92-93	S10 EL, 4x2 Tracción trasera	
F	83-92	S10 Tahoe, 4x2 Tracción trasera	
F	88-90	S10 Durango, 4x2 Tracción trasera	
F	82-86	S10 Durango, 4x2 Tracción trasera	
F	92-04	<b>GMC</b> JIMMY 4x2 Tracción trasera	
F	83-91	S15 JIMMY 4x2 Tracción trasera	
F	04	SONOMA / S15 Todos 4x2 Tracción trasera	
F	82-03	SONOMA / S15 4x2 Tracción trasera	
F	72-76	<b>MAZDA</b> B1600 Todos	
F	77-78	B1800 Todos	
F	79-84	B2000 Todos	
F	82-84	B2200 Todos	
<b>77422</b>	W		
R	05	<b>CHEVROLET</b> BLAZER Base, 4x4	
R	05	BLAZER Base, 4x2 Tracción trasera	
R	96-04	BLAZER LS, 4x4	
R	96-04	BLAZER LS, 4x2 Tracción trasera	
R	95-02	BLAZER LT, 4x2 Tracción trasera	
R	95-01	BLAZER LT, 4x4	
R	95-99	BLAZER Base, 4x4	
R	95-99	BLAZER Base, 4x2 Tracción trasera	
R	95-97	BLAZER Deluxe, 4x2 Tracción trasera	
R	83-94	BLAZER, S MODELS Todos	
R	99-04	S10 LS, 4x4	
R	99-03	S10 Base, 4x4	
R	99-03	S10 Base, 4x2 Tracción trasera	
R	99-03	S10 LS, 4x2 Tracción trasera	
R	94-98	S10 LS	
R	82-98	S10 Base	
R	92-93	S10 EL	
R	83-92	S10 Tahoe	
R	88-90	S10 Durango	
R	82-86	S10 Durango	
R	92-05	<b>GMC</b> JIMMY Todos	
R	83-91	S15 JIMMY Todos	
R	82-04	SONOMA / S15 Todos	
R	91	SYCLONE Todos	
R	92-93	TYPHOON Todos	
<b>77423</b>	D	140780	
F	05	<b>CHEVROLET</b> BLAZER Base, 4x4 Exc. ZR2	
F	00-04	BLAZER LS, 4x4 Exc. ZR2	
F	95-01	BLAZER LT, 4x4 Exc. ZR2	
F	95-99	BLAZER Base, 4x4 Exc. ZR2	
F	99	BLAZER LS, 4x4	
F	96-98	BLAZER LS, 4x4 Exc. ZR2	
F	83-94	BLAZER, S MODELS 4x4	
F	94-04	S10 LS, 4x4 Exc. ZR2, ZR5 or Sport Chassis	
F	92-03	S10 Base, 4x4 Exc. ZR2, ZR5 or Sport Chassis	
F	92-93	S10 EL, 4x4 Exc. ZR2, ZR5 or Sport Chassis	
F	83-92	S10 Tahoe, 4x4 Exc. ZR2, ZR5 or Sport Chassis	
F	91	S10 Base, 4x4	
F	88-90	S10 Durango, 4x4 Exc. ZR2, ZR5 or Sport Chassis	
F	83-90	S10 Base, 4x4 Exc. ZR2, ZR5 or Sport Chassis	
F	83-86	S10 Durango, 4x4 Exc. ZR2, ZR5 or Sport Chassis	

## Lista numérica

Amort.	POP	No. Alternativo	Montaje Accesorio
Pos.	Año	Aplicación	
<b>77423</b>	D	-continued	
F	92-05	<b>GMC</b> JIMMY 4x4	
F	83-91	S15 JIMMY 4x4	
F	83-04	SONOMA / S15 4x4	
F	91	SYCLONE Todos	
F	92-93	TYPHOON Todos	
<b>77424</b>	D	141353	
F	84-01	<b>JEEP</b> CHEROKEE Todos	
F	86-92	COMANCHE Todos	
F	93-98	GRAND CHEROKEE Todos	
F	84-90	WAGONEER Todos	
<b>77425</b>	W		
R	84-01	<b>JEEP</b> CHEROKEE Todos	
R	84-90	WAGONEER Todos	
<b>77454</b>	W		
R	90-05	<b>CHEVROLET</b> ASTRO Todos	
R	85-89	ASTRO 4x2 Tracción trasera	
R	90-05	<b>GMC</b> SAFARI Todos	
R	85-89	SAFARI 4x2 Tracción trasera	
<b>77455</b>	W		
F	86-97	<b>FORD</b> PICKUP 1 TON, F-350 / SUPERDUTY 4x4	
F	97-98	PICKUP 3/4 TON, F-250 / SUPERDUTY 4x4 PBV arriba de 8500#	
F	87-96	PICKUP 3/4 TON, F-250 / SUPERDUTY 4x4	
<b>77456</b>	W		
R	86-97	<b>FORD</b> PICKUP 1 TON, F-350 / SUPERDUTY 4x4 Exc. Doble Rodada Trasera	
<b>77461</b>	W		
R	80-96	<b>FORD</b> PICKUP 1/2 TON, F-150 4x4 Exc. Kit de Levantamiento	
R	86-97	PICKUP 1 TON, F-350 / SUPERDUTY 4x4 Doble Rodada Trasera	
R	82-85	PICKUP 1 TON, F-350 / SUPERDUTY 4x4 Montaje Inferior Delantero Tipo Abrazadera Exc. Doble Rodado o Kit de Levantamiento	
R	80-81	PICKUP 1 TON, F-350 / SUPERDUTY 4x4	
R	97	PICKUP 3/4 TON, F-250 / SUPERDUTY 4x4 PBV arriba de 8500#	
R	86-96	PICKUP 3/4 TON, F-250 / SUPERDUTY 4x4	
R	82-85	PICKUP 3/4 TON, F-250 / SUPERDUTY 4x4 Montaje Inferior Delantero Tipo Abrazadera Exc. Doble Rodado o Kit de Levantamiento	
R	80-81	PICKUP 3/4 TON, F-250 / SUPERDUTY 4x4	
R	99-04	PICKUP, F-450 SUPERDUTY Todos	
R	99-04	PICKUP, F-550 SUPERDUTY Todos	
<b>77479</b>	W	140524	
F	86-95	<b>TOYOTA</b> 4RUNNER Todos	
F	86-95	PICKUP 4x4 Exc. Kit de Levantamiento	
F	93-98	T100 4x4	
<b>77488</b>	W		
R	88-99	<b>CHEVROLET</b> PICKUP 1/2 TON, C15 / C1500 Todos	
R	88-99	PICKUP 1/2 TON, K15 / K1500 Todos	
R	01-03	PICKUP 1 TON, C35/3500 Base	
R	91-00	PICKUP 1 TON, C35/3500 Todos	
R	88-90	PICKUP 1 TON, C35/3500 Extended Cab Pickup Eje Delantero Rígido HD	
R	88-90	PICKUP 1 TON, C35/3500 Standard Cab Pickup Eje Delantero Rígido HD	
R	88-00	PICKUP 1 TON, K35 / K3500 Todos	
R	88-00	PICKUP 3/4 TON, C25 / C2500 Todos	
R	88-00	PICKUP 3/4 TON, K25 / K2500 Todos	
R	01-02	<b>GMC</b> C3500	
R	88-99	PICKUP 1/2 TON, C15 / C1500 Todos	
R	88-99	PICKUP 1/2 TON, K15 / K1500 Todos	
R	91-00	PICKUP 1 TON, C35/3500 Todos	
R	88-90	PICKUP 1 TON, C35/3500 Extended Cab Pickup Eje Delantero Rígido HD	

Lista numérica

Amort.	POP	No. Alternativo	Montaje Accesorio
Pos.	Año	Aplicación	
<b>77488</b>	W	-continued	
R	88-90	PICKUP 1 TON, C35/3500 Standard Cab Pickup Eje Delantero Rígido HD	
R	88-00	PICKUP 1 TON, K35 / K3500 Todos	
R	88-00	PICKUP 3/4 TON, C25 / C2500 Todos	
R	88-00	PICKUP 3/4 TON, K25 / K2500 Todos	
<b>77489</b>	W	141277	
F	88-99	CHEVROLET PICKUP 1/2 TON, C15 / C1500 Todos	
F	01-03	PICKUP 1 TON, C35/3500 Base Eje Delantero Rígido HD	
F	98-00	PICKUP 1 TON, C35/3500 Todos Eje Delantero Rígido HD	
F	92-97	PICKUP 1 TON, C35/3500 Crew Cab Pickup Eje Delantero Rígido HD	
F	88-97	PICKUP 1 TON, C35/3500 Extended Cab Pickup Eje Delantero Rígido HD	
F	88-97	PICKUP 1 TON, C35/3500 Standard Cab Pickup Eje Delantero Rígido HD	
F	88-00	PICKUP 3/4 TON, C25 / C2500 Todos	
F	92-99	SUBURBAN 1/2 TON, C15 / C1500 Todos	
F	92-99	SUBURBAN 3/4 TON, C25 / C2500 Todos	
F	95-00	TAHOE 4x2 Tracción trasera Old Body Style	
F	88-99	GMC PICKUP 1/2 TON, C15 / C1500 Todos	
F	88-00	PICKUP 1 TON, C35/3500 Extended Cab Pickup Eje Delantero Rígido HD	
F	88-00	PICKUP 1 TON, C35/3500 Standard Cab Pickup Eje Delantero Rígido HD	
F	88-00	PICKUP 3/4 TON, C25 / C2500 Todos	
F	92-99	SUBURBAN 1/2 TON, C15 / C1500 Todos	
F	92-99	SUBURBAN 3/4 TON, C25 / C2500 Todos	
F	92-99	YUKON 4x2 Tracción trasera	
<b>77492</b>	D	141137	
R	87-89	DODGE RAIDER 2.6L 4Cyl L (156) Exc. Sport Utility	
F	61-67	FORD ECONOLINE Todos	
F	68	VAN 1/2 TON, ECONOLINE / CLUB WAGON Todos Fabricado antes de Jul/68	
R	81-95	ISUZU PICKUP Todos	
R	86-92	JEEP COMANCHE Todos	
F	66-73	WAGONEER Todos	
F	63-65	WAGONEER Todos Exc. Suspensión Independiente Delantera	
R	00-04	NISSAN FRONTIER Crew Cab Pickup, 4x2 Tracción trasera con Desert Runner	
R	98-04	FRONTIER 4x4	
R	98-99	FRONTIER 4x2 Tracción trasera Crew Cab con Desert Runner	
R	95-97	PICKUP 4x4	
R	65-93	PICKUP	
R	85-92	TOYOTA PICKUP 4x2 Tracción trasera 1 Ton	
R	80-83	PICKUP 4x4 Exc. Kit de Levantamiento	
R	93-98	T100 4x2 Tracción trasera	
<b>77494</b>	W	140149	
R	84-89	TOYOTA 4RUNNER Todos	
R	84-95	PICKUP 4x4 Exc. Kit de Levantamiento	
R	98-04	TACOMA Pre Runner	
R	95-04	TACOMA 4x4	
<b>77524</b>	W		
R	06-11	FORD RANGER 4x2 Tracción trasera, Barra de Torsion (FrontSpringType)	
R	90-11	RANGER 4x4	
R	01-05	RANGER Edge, 4x2 Tracción trasera	
R	89	RANGER 4x4 Fab. desde 2/89; Vehículos con perno de 12mm en montaje inferior trasero	
R	95-96	MAZDA B2300 4x4	
R	03-06	B3000 Todos 4x4	
R	98-02	B3000 4x4	
R	98-06	B4000 4x4	
<b>77525</b>	W		
R	90	FORD BRONCO II Todos	

Amortiguador Monotubo MaxControl

Amort.	POP	No. Alternativo	Montaje Accesorio
Pos.	Año	Aplicación	
<b>77525</b>	W	-continued	
R	89	BRONCO II Todos Fab. desde 2/89; Vehículos con perno de 12mm en montaje inferior trasero	
R	06-11	RANGER 4x2 Tracción trasera, Coil (FrontSpringType)	
R	98-05	RANGER XL, 4x2 Tracción trasera	
R	98-05	RANGER XLT, 4x2 Tracción trasera	
R	05	RANGER STX, 4x2 Tracción trasera	
R	04	RANGER Tremor, 4x2 Tracción trasera	
R	90-97	RANGER 4x2 Tracción trasera	
R	89	RANGER 4x2 Tracción trasera Fab. desde 2/89; Vehículos con perno de 12mm en montaje inferior trasero	
R	01-06	MAZDA B2300 4x2 Tracción trasera	
R	94-97	B2300 4x2 Tracción trasera	
R	98-01	B2500 4x2 Tracción trasera	
R	94-06	B3000 4x2 Tracción trasera	
R	94-06	B4000 4x2 Tracción trasera	
<b>77607</b>	W	140719	
R	00-05	FORD EXCURSION 4x2 Tracción trasera	
R	91-94	EXPLORER Todos	
<b>77608</b>	W	140780	
F	91-94	FORD EXPLORER Todos	
F	92-11	VAN 1/2 TON, ECONOLINE / CLUB WAGON Todos	
<b>77609</b>	W		
F	99-00	CADILLAC ESCALADE Todos	
F	90-05	CHEVROLET ASTRO AWD	
F	92-94	BLAZER 4x4 Automóvil Grande	
F	88-99	PICKUP 1/2 TON, K15 / K1500 Todos	
F	88-00	PICKUP 1 TON, K35 / K3500 Todos	
F	88-00	PICKUP 3/4 TON, K25 / K2500 Todos	
F	92-99	SUBURBAN 1/2 TON, K15 / K1500 Todos	
F	92-99	SUBURBAN 3/4 TON, K25 / K2500 Todos	
F	95-00	TAHOE 4x4 Old Body Style	
F	88-99	GMC PICKUP 1/2 TON, K15 / K1500 Todos	
F	88-00	PICKUP 1 TON, K35 / K3500 Todos	
F	88-00	PICKUP 3/4 TON, K25 / K2500 Todos	
F	90-05	SAFARI AWD	
F	92-99	SUBURBAN 1/2 TON, K15 / K1500 Todos	
F	92-99	SUBURBAN 3/4 TON, K25 / K2500 Todos	
F	92-99	YUKON 4x4	
F	99	YUKON Denali	
<b>77614</b>	D	140780	
F	90	FORD BRONCO II Todos	
F	00-05	EXCURSION 4x2 Tracción trasera	
F	90-97	RANGER Todos	
F	07-11	VAN 1 TON, ECONOLINE / CLUB WAGON / SUPERDUTY Todos Exc. Paquete de Ambulancia & Manejo	
F	03-10	VAN 1 TON, ECONOLINE / CLUB WAGON / SUPERDUTY Todos	
F	92-05	VAN 1 TON, ECONOLINE / CLUB WAGON / SUPERDUTY Todos Conversión a Motorhome	
F	92-11	VAN 3/4 TON, ECONOLINE / CLUB WAGON / SUPERDUTY Todos	
F	94-97	MAZDA B2300 Todos	
F	94-97	B3000 4x2 Tracción trasera	
F	94-97	B4000 4x2 Tracción trasera	
<b>77623</b>	W	142731	
R	03-11	FORD VAN 1 TON, ECONOLINE / CLUB WAGON / SUPERDUTY Todos Exc. Paquete de Ambulancia & Manejo	
R	07-08	VAN 1 TON, ECONOLINE / CLUB WAGON / SUPERDUTY Todos	
R	92-05	VAN 1 TON, ECONOLINE / CLUB WAGON / SUPERDUTY Todos Conversión a Motorhome	
R	92-11	VAN 3/4 TON, ECONOLINE / CLUB WAGON / SUPERDUTY Todos	
<b>77638</b>	D		
R	99-00	CADILLAC ESCALADE Todos	
R	92-94	CHEVROLET BLAZER 4x4 Automóvil Grande	
R	92-99	SUBURBAN 1/2 TON, C15 / C1500 Todos	

Lista numérica

Amort.	POP	No. Alternativo	Montaje Accesorio
Pos.	Año	Aplicación	
<b>77638</b>	D	-continued	
R	92-99	SUBURBAN 1/2 TON, K15 / K1500 Todos	
R	92-99	SUBURBAN 3/4 TON, C25 / C2500 Todos	
R	92-99	SUBURBAN 3/4 TON, K25 / K2500 Todos	
R	95-00	TAHOE Todos Old Body Style	
R	96-11	VAN 1/2 TON, G / EXPRESS Todos	
R	96-12	VAN 1 TON, G / EXPRESS Todos	
R	03-12	VAN 3/4 TON, G / EXPRESS Todos	
R	96-02	VAN 3/4 TON, G / EXPRESS Todos Exc. PBV 8600 #	
R	92-99	GMC SUBURBAN 1/2 TON, C15 / C1500 Todos	
R	92-99	SUBURBAN 1/2 TON, K15 / K1500 Todos	
R	92-99	SUBURBAN 3/4 TON, C25 / C2500 Todos	
R	92-99	SUBURBAN 3/4 TON, K25 / K2500 Todos	
R	96-11	VAN 1/2 TON, G / SAVANNA 4x2 Tracción trasera	
R	04-12	VAN 1 TON, G / SAVANNA Todos	
R	96-02	VAN 1 TON, G / SAVANNA Todos Exc. PBV 8600 #	
R	96	VAN 1 TON, G / SAVANNA Todos 7100, 7400, y 8600# PBV	
R	03-12	VAN 3/4 TON, G / SAVANNA Todos	
R	96-02	VAN 3/4 TON, G / SAVANNA Todos Exc. PBV 8600 #	
R	92-99	YUKON Todos	
R	99	YUKON Denali	
<b>77660</b>	W		
R	93-98	TOYOTA T100 4x4	
<b>77661</b>	D	143000	
F	94-01	DODGE PICKUP 1/2 TON, RAM 1500 4x2 Tracción trasera	
F	94-02	PICKUP 1 TON, RAM 3500 4x2 Tracción trasera Exc. Eje Delantero Rígido	
F	94-02	PICKUP 3/4 TON, RAM 2500 4x2 Tracción trasera	
<b>77662</b>	D		
R	03-07	CHEVROLET CHEYENNE PICKUP 1/2 TON, SILVERADO 1500 Classic Hybrid, 4x2 Tracción trasera	
R	07	PICKUP 1/2 TON, SILVERADO 1500 Classic LS, 4x2 Tracción trasera	
R	07	PICKUP 1/2 TON, SILVERADO 1500 Classic LT, 4x2 Tracción trasera	
R	07	PICKUP 1/2 TON, SILVERADO 1500 Classic SS, 4x2 Tracción trasera	
R	07	PICKUP 1/2 TON, SILVERADO 1500 Classic WT, 4x2 Tracción trasera	
R	99-06	PICKUP 1/2 TON, SILVERADO 1500 4x2 Tracción trasera Exc. Suspensión Electrónica Ajustable	
R	74-80	VAN 1/2 TON, P SERIES Todos	
R	79-89	VAN 3/4 TON, P SERIES Todos	
R	94-01	DODGE PICKUP 1/2 TON, RAM 1500 Todos	
R	94-02	PICKUP 1 TON, RAM 3500 4x2 Tracción trasera Exc. Eje Delantero Rígido	
R	94-02	PICKUP 3/4 TON, RAM 2500 4x4, GAS Exc. PBV 8600 #	
R	94-02	PICKUP 3/4 TON, RAM 2500 4x2 Tracción trasera	
R	95-96	PICKUP 3/4 TON, RAM 2500 4x4, CNG Exc. PBV 8600 #	
R	07	GMC SIERRA 1500 Classic Hybrid, 4x2 Tracción trasera Exc. Suspensión Electrónica Ajustable	
R	07	SIERRA 1500 Classic SL, 4x2 Tracción trasera Exc. Suspensión Electrónica Ajustable	
R	07	SIERRA 1500 Classic SLE, 4x2 Tracción trasera Exc. Suspensión Electrónica Ajustable	
R	07	SIERRA 1500 Classic SLT, 4x2 Tracción trasera Exc. Suspensión Electrónica Ajustable	
R	07	SIERRA 1500 Classic WT, 4x2 Tracción trasera Exc. Suspensión Electrónica Ajustable	



Lista numérica

Amort.	POP	No. Alternativo	Montaje Accesorio
Pos.	Año	Aplicación	
77662	D	-continued	
R	99-06	SIERRA 1500 4x2	Tracción trasera Exc. Suspensión Electrónica Ajustable
R	74-80	VAN 1/2 TON, P SERIES Todos	
R	75-99	VAN 1 TON, P SERIES Todos	
R	73-74	VAN 1 TON, P SERIES Base Exc. Chasis Motorhome	
77673	W	142731	
F	94-01	DODGE PICKUP 1/2 TON, RAM 1500 4x4	
F	94-02	PICKUP 3/4 TON, RAM 2500 4x4, GAS Exc. PBV 8600 #	
77674	W	142731	
F	94-02	DODGE PICKUP 1 TON, RAM 3500 4x4	
F	94-02	PICKUP 1 TON, RAM 3500 4x2 Tracción trasera Eje Delantero Rígido	
F	94-02	PICKUP 3/4 TON, RAM 2500 4x4, DIESEL PBV 8800	
77675	W		
R	94-02	DODGE PICKUP 1 TON, RAM 3500 4x4	
R	94-02	PICKUP 1 TON, RAM 3500 4x2 Tracción trasera Eje Delantero Rígido	
R	94-02	PICKUP 3/4 TON, RAM 2500 4x4, DIESEL PBV 8800	
77678	D	142277	
F	95-01	FORD EXPLORER Todos Exc. Suspensión de Aire	
F	01-05	EXPLORER SPORT TRAC Todos	
F	06-11	RANGER 4x2 Tracción trasera, Barra de Torsión (FrontSpringType)	
F	98-11	RANGER 4x4	
F	01-05	RANGER Edge, 4x2 Tracción trasera	
F	03-06	MAZDA B3000 Todos 4x4	
F	98-02	B3000 4x4	
F	98-06	B4000 4x4	
77679	W	140719	
R	95-01	FORD EXPLORER Todos Exc. Suspensión de Aire	
R	01-05	EXPLORER SPORT TRAC Todos	
77683	W		
R	93-98	JEEP GRAND CHEROKEE Todos	
77714	D	142731	
F	97-02	FORD EXPEDITION 4x2 Tracción trasera Exc. Nivelación Nuemática Delantera	
F	97-04	PICKUP 1/2 TON, F-150 4x2 Tracción trasera	
F	96-99	PICKUP 3/4 TON, F-250 / SUPERDUTY 4x2 Tracción trasera Hasta PBV 8500#	
F	98-02	LINCOLN NAVIGATOR 4x2 Tracción trasera	
77715	W	142700	
R	97-04	FORD PICKUP 1/2 TON, F-150 4x4 Exc. PBV 7700#	
R	97-99	PICKUP 3/4 TON, F-250 / SUPERDUTY 4x4 Hasta PBV 8500#, Exc. Superduty	
77716	W	142731	
F	97-02	FORD EXPEDITION 4x4 Exc. Nivelación Nuemática Delantera	
F	04	PICKUP 1/2 TON, F-150 4x4 Exc. PBV 7700#	
F	97-03	PICKUP 1/2 TON, F-150 4x4	
F	97-99	PICKUP 3/4 TON, F-250 / SUPERDUTY 4x4 Hasta PBV 8500#, Exc. Superduty	
77717	W		
R	97-02	FORD EXPEDITION Todos	
R	98-02	LINCOLN NAVIGATOR 4x2 Tracción trasera	
77726	W	140921	
R	90-02	TOYOTA 4RUNNER Todos	
77722	D	140780	
F	06-11	FORD RANGER 4x2 Tracción trasera. Coil (FrontSpringType)	
F	98-05	RANGER XL, 4x2 Tracción trasera	
F	98-05	RANGER XLT, 4x2 Tracción trasera	
F	05	RANGER STX, 4x2 Tracción trasera	

Amortiguador Monotubo MaxControl

Amort.	POP	No. Alternativo	Montaje Accesorio
Pos.	Año	Aplicación	
77772	D	-continued	
F	04	RANGER Tremor, 4x2 Tracción trasera	
F	01-06	MAZDA B2300 4x2 Tracción trasera	
F	98-01	B2500 4x2 Tracción trasera	
F	98-06	B3000 4x2 Tracción trasera	
F	98-06	B4000 4x2 Tracción trasera	
77778	W	142700	
R	04	FORD PICKUP 1/2 TON, F-150 4x2 Tracción trasera	
R	00-03	PICKUP 1/2 TON, F-150 Harley-Davidson Edition, 4x2 Tracción trasera	
R	99-03	PICKUP 1/2 TON, F-150 Lariat, 4x2 Tracción trasera	
R	99-03	PICKUP 1/2 TON, F-150 XL, 4x2 Tracción trasera	
R	99-03	PICKUP 1/2 TON, F-150 XLT, 4x2 Tracción trasera	
R	00	PICKUP 1/2 TON, F-150 Base, 4x2 Tracción trasera	
R	97-98	PICKUP 1/2 TON, F-150 4x2 Tracción trasera	
R	97-99	PICKUP 3/4 TON, F-250 / SUPERDUTY 4x2 Tracción trasera Hasta PBV 8500#	
77783	W	141665	
F	03-07	CHEVROLET CHEYENNE PICKUP 1/2 TON, SILVERADO 1500 Classic Hybrid, 4x2 Tracción trasera Exc. Suspensión Electrónica Ajustable	
F	07	PICKUP 1/2 TON, SILVERADO 1500 Classic LS, 4x2 Tracción trasera Exc. Suspensión Electrónica Ajustable	
F	07	PICKUP 1/2 TON, SILVERADO 1500 Classic LT, 4x2 Tracción trasera Exc. Suspensión Electrónica Ajustable	
F	07	PICKUP 1/2 TON, SILVERADO 1500 Classic SS, 4x2 Tracción trasera Exc. Suspensión Electrónica Ajustable	
F	07	PICKUP 1/2 TON, SILVERADO 1500 Classic WT, 4x2 Tracción trasera Exc. Suspensión Electrónica Ajustable	
F	99-06	PICKUP 1/2 TON, SILVERADO 1500 4x2 Tracción trasera Exc. Suspensión Electrónica Ajustable	
F	07	PICKUP 1/2 TON, SILVERADO 1500 Classic SL, 4x2 Tracción trasera Exc. Suspensión Electrónica Ajustable	
F	07	PICKUP 1/2 TON, SILVERADO 1500 Classic SLE, 4x2 Tracción trasera Exc. Suspensión Electrónica Ajustable	
F	07	PICKUP 1/2 TON, SILVERADO 1500 Classic SLT, 4x2 Tracción trasera Exc. Suspensión Electrónica Ajustable	
F	07	PICKUP 1/2 TON, SILVERADO 1500 Classic WT, 4x2 Tracción trasera Exc. Suspensión Electrónica Ajustable	
F	99-06	SIERRA 1500 4x2 Tracción trasera Exc. Suspensión Electrónica Ajustable	
77803	D	143276	
F	02-06	CHEVROLET AVALANCHE 1500 Todos Exc. Control de Manejo Electrónico	
F	03-07	CHEYENNE PICKUP 1/2 TON, SILVERADO 1500 Classic Hybrid, 4x4 Classic y Old Body Style; Exc. Suspensión Electrónica Ajustable	
F	07	PICKUP 1/2 TON, SILVERADO 1500 Classic LS, 4x4 Classic y Old Body Style; Exc. Suspensión Electrónica Ajustable	
F	07	PICKUP 1/2 TON, SILVERADO 1500 Classic LT, 4x4 Classic y Old Body Style; Exc. Suspensión Electrónica Ajustable	
F	07	PICKUP 1/2 TON, SILVERADO 1500 Classic WT, 4x4 Classic y Old Body Style; Exc. Suspensión Electrónica Ajustable	

Lista numérica

Amort.	POP	No. Alternativo	Montaje Accesorio
Pos.	Año	Aplicación	
77803	D	-continued	
F	99-06	PICKUP 1/2 TON, SILVERADO 1500 4x4 Classic y Old Body Style; Exc. Suspensión Electrónica Ajustable	
F	00-06	SUBURBAN 1/2 TON, 1500 Todos Exc. Suspensión Z55 Auto Ride	
F	02-06	TAHOE Todos Exc. Suspensión Z55 Auto Ride	
F	00-01	TAHOE Todos Estilo New Body, Exc. Suspensión Z55	
F	07	GMC SIERRA 1500 Classic Hybrid, 4x4 Classic y Old Body Style; Exc. Suspensión Electrónica Ajustable	
F	07	SIERRA 1500 Classic SL, 4x4 Classic y Old Body Style; Exc. Suspensión Electrónica Ajustable	
F	07	SIERRA 1500 Classic SLE, 4x4 Classic y Old Body Style; Exc. Suspensión Electrónica Ajustable	
F	07	SIERRA 1500 Classic SLT, 4x4 Classic y Old Body Style; Exc. Suspensión Electrónica Ajustable	
F	07	SIERRA 1500 Classic WT, 4x4 Classic y Old Body Style; Exc. Suspensión Electrónica Ajustable	
F	99-06	SIERRA 1500 4x4 Classic y Old Body Style; Exc. Suspensión Electrónica Ajustable	
F	00-06	YUKON Todos Exc. Suspensión Z55 Auto Ride	
F	00-06	YUKON XL 1/2 TON Todos Exc. Suspensión Z55 Auto Ride	
77807	W	142617	
F	99-12	FORD PICKUP 1 TON, F-350 / SUPERDUTY 4x2 Tracción trasera	
F	99-12	PICKUP 3/4 TON, F-250 / SUPERDUTY 4x2 Tracción trasera	
77808	W		
R	99-04	FORD PICKUP 1 TON, F-350 / SUPERDUTY 4x2 Tracción trasera	
R	99-04	PICKUP 3/4 TON, F-250 / SUPERDUTY 4x2 Tracción trasera	
77809	W		
F	00-05	FORD EXCURSION 4x4	
F	99-04	PICKUP 1 TON, F-350 / SUPERDUTY 4x4	
F	99-04	PICKUP 3/4 TON, F-250 / SUPERDUTY 4x4	
F	99-04	PICKUP, F-450 SUPERDUTY Todos	
F	99-04	PICKUP, F-550 SUPERDUTY Todos	
77810	W		
R	99-04	FORD PICKUP 1 TON, F-350 / SUPERDUTY 4x4	
R	99-04	PICKUP 3/4 TON, F-250 / SUPERDUTY 4x4	
77815	W	142389	
R	00-06	TOYOTA TUNDRA Todos	
77817	D	141665	
F	02-06	CHEVROLET AVALANCHE 2500 Todos Exc. Control de Manejo Electrónico	
F	05-07	PICKUP 1/2 TON, SILVERADO 1500 HD Todos	
F	01-03	PICKUP 1/2 TON, SILVERADO 1500 HD Todos	
F	01-09	PICKUP 1 TON, SILVERADO 3500 Todos	
F	07-10	PICKUP 1 TON, SILVERADO 3500 HD Todos	
F	05-08	PICKUP 3/4 TON, SILVERADO 2500 Todos	
F	99-04	PICKUP 3/4 TON, SILVERADO 2500 4x4	
F	01-10	PICKUP 3/4 TON, SILVERADO 2500 HD Todos PBV 9200	
F	00-11	SUBURBAN 3/4 TON, 2500 Todos Exc. Suspensión Auto Ride Z55 y Quadrateer	
F	05-07	GMC SIERRA 1500 HD Todos	
F	01-03	SIERRA 1500 HD Todos	
F	99-04	SIERRA 2500 4x4	
F	01-10	SIERRA 2500 HD Todos	
F	01-07	SIERRA 3500 Todos	
F	07-10	SIERRA 3500 HD Barra de Torsión (FrontSpringType)	
F	00-06	YUKON XL 3/4 TON Todos Exc. Sistema de Autonivelación NIVOMAT	
F	03-06	HUMMER H2 Todos	

Lista numérica

Amortiguador Monotubo MaxControl, Amortiguadores Guardian

Lista numérica

Amort.	POP	No. Alternativo	Montaje Accesorio
Pos.	Año	Aplicación	
77829	D		142592,141353
R	99-04	JEEP GRAND CHEROKEE Todos	
77837	W		140857
R	00-05	FORD EXCURSION 4x4	
77847	D		142592,141353
F	99-04	JEEP GRAND CHEROKEE Todos Exc. Suspensión Up Country	
77902	D		140857
F	81-95	ISUZU PICKUP 4x2 Tracción trasera	
F	98-12	NISSAN PICKUP	
F	95-97	PICKUP 4x4	
F	65-94	PICKUP	
77903	W		141376
F	85-95	TOYOTA PICKUP 4x2 Tracción trasera Exc. 1 Ton	
F	84	PICKUP 4x2 Tracción trasera	
F	93-98	T100 4x2 Tracción trasera	
77904	W		141356
F	87-90	MITSUBISHI VAN Todos	
77907	D		
R	87-93	DODGE PICKUP, RAM 50 4x2 Tracción trasera	
R	83-86	PICKUP, RAM 50 Todos	
R	86-87	MAZDA B2000 4x2 Tracción trasera	
R	87-93	B2200 4x2 Tracción trasera	
R	87-93	B2600 4x2 Tracción trasera	
R	87-90	MITSUBISHI VAN Todos	
R	98-04	NISSAN FRONTIER 4x2 Tracción trasera Exc. Desert Runner	
R	05-12	PICKUP	
R	95-04	PICKUP 4x2 Tracción trasera	
R	65-94	PICKUP	
R	85-95	TOYOTA PICKUP 4x2 Tracción trasera Exc. 1 Ton	
R	84	PICKUP 4x2 Tracción trasera	
R	70-83	PICKUP 4x2 Tracción trasera Mojave	
R	84-88	VAN Leaf (RearSpringType)	
R	88	VAN WAGON Leaf (FrontSpringType), Leaf (RearSpringType)	
77909	D		141368
F	81-95	ISUZU PICKUP 4x4	
F	98-04	NISSAN FRONTIER 4x2 Tracción trasera Exc. Desert Runner	
F	95-97	PICKUP 4x2 Tracción trasera	
F	65-93	PICKUP	
77937	W		140673
F	01-04	TOYOTA TACOMA S-Runner Exc. Off Road Package	
F	04	TACOMA Base, 4x2 Tracción trasera Exc. Off Road Package	
F	95-03	TACOMA DLX, 4x2 Tracción trasera Exc. Off Road Package	
77947	W		142731
F	02-05	DODGE PICKUP 1/2 TON, RAM 1500 4x4	
77948	D		142731
F	03-10	DODGE PICKUP 1 TON, RAM 3500 4x4	
F	03-10	PICKUP 3/4 TON, RAM 2500 4x4	
F	11-13	RAM 2500 (SEE DODGE RAM 2500) 4x4	
77949	C		143000
F	03-10	DODGE PICKUP 1 TON, RAM 3500 4x2 Tracción trasera	
F	03-10	PICKUP 3/4 TON, RAM 2500 4x2 Tracción trasera	
F	11-12	RAM 2500	
F	11-12	RAM 3500	
F	11-13	RAM 2500 (SEE DODGE RAM 2500) 4x2 Tracción trasera	
77950	D		
R	03-10	DODGE PICKUP 1 TON, RAM 3500 Todos	
R	03-10	PICKUP 3/4 TON, RAM 2500 Todos	
R	11-12	RAM 2500	
R	11-12	RAM 3500	
R	11-13	RAM 2500 (SEE DODGE RAM 2500) Todos	
77951	W		142731
F	05-12	FORD PICKUP 1 TON, F-350 / SUPERDUTY 4x4	

Amort.	POP	No. Alternativo	Montaje Accesorio
Pos.	Año	Aplicación	
77951	W	-continued	142731
F	05-12	PICKUP 3/4 TON, F-250 / SUPERDUTY 4x4	
77952	D		
R	05-12	FORD PICKUP 1 TON, F-350 / SUPERDUTY Crew Cab Pickup, 4x4 Rodada Trasera Sencilla	
R	05-12	PICKUP 1 TON, F-350 / SUPERDUTY Extended Cab Pickup, 4x4 Rodada Trasera Sencilla	
R	05-12	PICKUP 1 TON, F-350 / SUPERDUTY Standard Cab Pickup, 4x4 Rodada Trasera Sencilla	
R	05-12	PICKUP 3/4 TON, F-250 / SUPERDUTY 4x4	
77953	D		
R	02-10	CADILLAC ESCALADE Todos	
R	07-11	CHEVROLET AVALANCHE 1500 Todos Exc. Suspensión Z55 o ZW7	
R	02-06	AVALANCHE 1500 Todos Exc. Control de Manejo Electrónico	
R	02-06	AVALANCHE 2500 Todos Exc. Control de Manejo Electrónico	
R	07-11	SUBURBAN 1/2 TON, 1500 Todos Exc. Suspensión Z55 o ZW7	
R	00-06	SUBURBAN 1/2 TON, 1500 Todos Exc. Suspensión Z55 Auto Ride	
R	00-11	SUBURBAN 3/4 TON, 2500 Todos Exc. Suspensión Auto Ride Z55 y Quadrateer	
R	07-11	TAHOE Todos Exc. Suspensión Z55 o ZW7	
R	02-06	TAHOE Todos Exc. Suspensión Z55 Auto Ride	
R	00-01	TAHOE Todos Estilo New Body, Exc. Suspensión Z55	
R	07-11	GMC YUKON Todos Exc. Suspensión Z55 o ZW7	
R	00-06	YUKON Todos Exc. Suspensión Z55 Auto Ride	
R	07-11	YUKON XL 1/2 TON Todos Exc. Suspensión Z55 o ZW7	
R	00-06	YUKON XL 1/2 TON Todos Exc. Suspensión Z55 Auto Ride	
R	07-11	YUKON XL 3/4 TON Todos Exc. Suspensión Z55 o ZW7	
R	00-06	YUKON XL 3/4 TON Todos Exc. Sistema de Autonivelación NIVOMAT	
77954	D		143276
F	06-08	DODGE PICKUP 1/2 TON, RAM 1500 Crew Cab Pickup, 4x2 Tracción trasera	
F	06-08	PICKUP 1/2 TON, RAM 1500 Standard Cab Pickup, 4x2 Tracción trasera	
F	02-05	PICKUP 1/2 TON, RAM 1500 4x2 Tracción trasera	
77955	X		142486
R	03-10	FORD CROWN VICTORIA Police Interceptor Modelos Policía y Taxi	
77967	W		
F	05-08	FORD PICKUP, F-450 SUPERDUTY Todos	
F	05-07	PICKUP, F-550 SUPERDUTY Todos	
77968	W		
R	05-07	FORD PICKUP, F-450 SUPERDUTY 4x2 Tracción trasera	
R	05-07	PICKUP, F-550 SUPERDUTY 4x2 Tracción trasera	
77969	W		
R	05-07	FORD PICKUP, F-450 SUPERDUTY 4x4	
R	05-07	PICKUP, F-550 SUPERDUTY 4x4	
77971	N		
R	02-09	CHEVROLET TRAILBLAZER Coil (RearSpringType)	
R	02-06	TRAILBLAZER EXT Todos	
R	02-09	GMC ENVOY Coil (RearSpringType)	
R	02-06	ENVOY XL Todos	
R	04-05	ENVOY XUV Todos	
77972	N		
F	07-12	JEEP WRANGLER Todos	
77973	N		
R	07-14	JEEP WRANGLER Unlimited Sahara, 4x4	

Amort.	POP	No. Alternativo	Montaje Accesorio
Pos.	Año	Aplicación	
77973	N	-continued	
R	07-11	WRANGLER Unlimited X, 4x4	
R	07-11	WRANGLER X	
79900	S		141727
F	10-11	FORD CROWN VICTORIA Base	
F	06-11	CROWN VICTORIA LX	
F	06-08	CROWN VICTORIA Base	
F	06	CROWN VICTORIA LX Sport	
F	05	CROWN VICTORIA Base Fab. hasta 12/05	
F	05	CROWN VICTORIA LX Fab. hasta 12/05	
F	05	CROWN VICTORIA LX Sport Fab. hasta 12/05	
F	05	CROWN VICTORIA S Fab. hasta 12/05	
F	05	CROWN VICTORIA Special Edition Fab. hasta 12/05	
F	03-04	CROWN VICTORIA Base	
F	03-04	CROWN VICTORIA LX	
F	04	CROWN VICTORIA LX Sport Exc. Modelos Policía y Taxi	
F	03	CROWN VICTORIA LWB	
F	03	CROWN VICTORIA S	
79901	S		141727
F	06-11	FORD CROWN VICTORIA Police Interceptor	
F	05	CROWN VICTORIA Police Interceptor Fab. hasta 12/05	
F	03-04	CROWN VICTORIA Police Interceptor	
<b>Amortiguadores Guardian</b>			
81039	C		140357
F	69-84	CHEVROLET BLAZER 4x2 Tracción trasera	
F	63-86	PICKUP 1/2 TON, C10 Todos	
F	87	PICKUP 1/2 TON, R10 Todos	
F	63-86	PICKUP 1 TON, C30 Todos	
F	88-91	PICKUP 1 TON, C35/3500 Cab & Chassis	
F	87-88	PICKUP 1 TON, R30 Todos	
F	90-91	PICKUP 1 TON, R3500 Todos	
F	89	PICKUP 1 TON, R3500 Standard Cab Pickup	
F	63-74	PICKUP 3/4 TON, C20 Todos	
F	88	PICKUP 3/4 TON, R20 Todos	
F	87	PICKUP 3/4 TON, R20 Crew Cab Pickup	
F	89	PICKUP 3/4 TON, R2500 Todos	
F	63-67	SUBURBAN 1/2 TON, 1500 Todos	
F	63-86	SUBURBAN 1/2 TON, C10 Todos	
F	87-88	SUBURBAN 1/2 TON, R10 Todos	
F	89-91	SUBURBAN 1/2 TON, R1500 Todos	
F	68-86	SUBURBAN 3/4 TON, C20 Todos	
F	87-88	SUBURBAN 3/4 TON, R20 Todos	
F	89-91	SUBURBAN 3/4 TON, R2500 Todos	
F	63-80	VAN 1/2 TON, P SERIES Todos	
F	68-89	VAN 3/4 TON, P SERIES Todos	
F	75-84	GMC JIMMY 4x2 Tracción trasera	
F	70-74	JIMMY Todos 4x2 Tracción trasera	
F	91	P3500	
F	67-86	PICKUP 1/2 TON, C15 / C1500 Todos	
F	87	PICKUP 1/2 TON, R1500 Todos	
F	88-91	PICKUP 1 TON, C35/3500 Cab & Chassis	
F	67-78	PICKUP 1 TON, C35/3500 Todos	
F	87-91	PICKUP 1 TON, R3500 Todos	
F	75-86	PICKUP 3/4 TON, C25 / C2500 Cab & Chassis	
F	75-86	PICKUP 3/4 TON, C25 / C2500 Crew Cab Pickup	
F	75-86	PICKUP 3/4 TON, C25 / C2500 Standard Cab Pickup	
F	67-74	PICKUP 3/4 TON, C25 / C2500 Todos	
F	87-89	PICKUP 3/4 TON, R2500 Todos Exc. Crew Cab & Bonus Cab	
F	63-65	PICKUP 1500 SERIES Todos	
F	73-86	SUBURBAN 1/2 TON, C15 / C1500 Todos	
F	68-72	SUBURBAN 1/2 TON, C15 / C1500 Todos Coil (FrontSpringType)	
F	87-91	SUBURBAN 1/2 TON, R1500 Todos	
F	68-86	SUBURBAN 3/4 TON, C25 / C2500 Todos	
F	87-91	SUBURBAN 3/4 TON, R2500 Todos	
F	67-80	VAN 1/2 TON, P SERIES Todos	
F	91	VAN 1 TON, P SERIES Todos	
F	75-90	VAN 1 TON, P SERIES Todos Exc. Chasis Motorhome	

# Lista numérica

Amort.	POP	No. Alternativo	Montaje Accesorio
Pos.	Año	Aplicación	
<b>81039</b>	C	-continued	140357
F	73-74	VAN 1 TON, P SERIES Base Exc. Chasis Motorhome	
F	68-72	VAN 1 TON, P SERIES Todos	
F	68-89	VAN 3/4 TON, P SERIES Todos	
F	63-65	VAN, PB 1000 SERIES Todos	
<b>81082</b>	C		
R	92	FORD B200	
R	85-96	PICKUP 1/2 TON, F-150 4x2 Tracción trasera	
R	80-97	PICKUP 1 TON, F-350 / SUPERDUTY 4x2 Tracción trasera Exc. Doble Rodada Trasera	
R	97	PICKUP 3/4 TON, F-250 / SUPERDUTY 4x2 Tracción trasera PBV arriba de 8500#	
R	80-96	PICKUP 3/4 TON, F-250 / SUPERDUTY 4x2 Tracción trasera	
<b>81091</b>	W		
R	72-93	DODGE PICKUP 1/2 TON, D100 SERIES Todos	
R	72-93	PICKUP 1 TON, D300 SERIES Todos	
R	72-93	PICKUP 3/4 TON, D200 SERIES Todos	
R	95-96	RAMCHARGER 4x2 Tracción trasera	
R	74-93	RAMCHARGER 4x2 Tracción trasera	
R	75-81	PLYMOUTH TRAILDUSTER 4x2 Tracción trasera	
R	74	TRAILDUSTER Todos	
<b>81096</b>	D		140126
F	72-93	DODGE PICKUP 1/2 TON, D100 SERIES Todos	
F	94	PICKUP 1 TON, RAM 3500 Todos	
F	72-93	PICKUP 3/4 TON, D200 SERIES Todos Exc. Paquete HD	
F	95-96	RAMCHARGER Todos	
F	75-93	RAMCHARGER 4x2 Tracción trasera	
F	99-03	VAN 1/2 TON, A / B SERIES / RAM 109.3 (WheelBase) Exc. PBV 7000#	
F	81-98	VAN 1/2 TON, A / B SERIES / RAM 109.6 (WheelBase) Exc. PBV 7000#	
F	71-80	VAN 1/2 TON, A / B SERIES / RAM Todos	
F	99-03	VAN 1 TON, A / B SERIES / RAM Todos	
F	71-98	VAN 1 TON, A / B SERIES / RAM Todos Exc. Eje Delantero 4000#	
F	71-03	VAN 3/4 TON, A / B SERIES / RAM Todos	
F	74-80	VAN, CB300 Todos Exc. Eje Delantero 4000#	
F	75-81	PLYMOUTH TRAILDUSTER 4x2 Tracción trasera	
F	74-83	VAN 1/2 TON, PB SERIES Todos	
F	74-83	VAN 1 TON, PB SERIES Todos Exc. Eje Delantero 4000#	
F	74-83	VAN 3/4 TON, PB SERIES Todos	
<b>81108</b>	C		
F	71-95	CHEVROLET VAN 1/2 TON, G / EXPRESS Todos	
F	70	VAN 1/2 TON, G / EXPRESS Todos Suspensión Delantera Independiente	
F	76-96	VAN 1 TON, G / EXPRESS Todos	
F	75	VAN 1 TON, G / EXPRESS 146.0 (WheelBase)	
F	71-74	VAN 1 TON, G / EXPRESS Todos	
F	78-95	VAN 3/4 TON, G / EXPRESS Todos Exc. PBV 8600 #	
F	71-77	VAN 3/4 TON, G / EXPRESS Todos	
F	70	VAN 3/4 TON, G / EXPRESS Todos Suspensión Delantera Independiente	
F	71-95	GMC VAN 1/2 TON, G / SAVANNA Todos	
F	70	VAN 1/2 TON, G / SAVANNA Todos Suspensión Delantera Independiente	
F	76-95	VAN 1 TON, G / SAVANNA Todos	
F	75	VAN 1 TON, G / SAVANNA 146.0 (WheelBase)	
F	71-74	VAN 1 TON, G / SAVANNA Todos	
F	78-95	VAN 3/4 TON, G / SAVANNA Todos Exc. PBV 8600 #	
F	71-77	VAN 3/4 TON, G / SAVANNA Todos	
F	70	VAN 3/4 TON, G / SAVANNA Todos Suspensión Delantera Independiente	

# Amortiguadores Guardian

Amort.	POP	No. Alternativo	Montaje Accesorio
Pos.	Año	Aplicación	
<b>81113</b>	W		
F	87-91	CHEVROLET BLAZER 4x4 Automóvil Grande; Suspensión Quad Amortiguador Corto; Exc. Kit de Levantamiento	
F	81-86	BLAZER 4x4 Suspensión Quad Amortiguador Corto; Exc. Kit de Levantamiento	
F	75-80	BLAZER 4x4 Exc. Suspensión Quad y Kit de Levantamiento	
F	73-74	BLAZER 4x4 Exc. Kit de Levantamiento	
F	69-72	BLAZER 4x4	
F	81-86	PICKUP 1/2 TON, K10 Todos Suspensión Estándar; Exc. Kit de Levantamiento	
F	69-80	PICKUP 1/2 TON, K10 Todos Exc. Kit de Levantamiento	
F	87	PICKUP 1/2 TON, V10 Todos Suspensión Quad Amortiguador Corto; Exc. Kit de Levantamiento	
F	81-86	PICKUP 3/4 TON, K20 Todos Suspensión Estándar; Exc. Kit de Levantamiento	
F	69-80	PICKUP 3/4 TON, K20 Todos Exc. Kit de Levantamiento	
F	81-86	SUBURBAN 1/2 TON, K10 Todos Suspensión Estándar; Exc. Kit de Levantamiento	
F	69-80	SUBURBAN 1/2 TON, K10 Todos Exc. Kit de Levantamiento	
F	87-88	SUBURBAN 1/2 TON, V10 Todos Suspensión Quad Amortiguador Corto; Exc. Kit de Levantamiento	
F	81-86	SUBURBAN 3/4 TON, K20 Todos Suspensión Estándar; Exc. Kit de Levantamiento	
F	69-80	SUBURBAN 3/4 TON, K20 Todos Exc. Kit de Levantamiento	
F	87-88	SUBURBAN 3/4 TON, V20 Todos Suspensión Quad Amortiguador Corto; Exc. Kit de Levantamiento	
F	89-91	SUBURBAN 3/4 TON, V2500 Todos Suspensión Quad Amortiguador Corto; Exc. Kit de Levantamiento	
F	70-91	GMC JIMMY 4x4 Exc. Suspensión Quad y Kit de Levantamiento	
F	69-86	PICKUP 1/2 TON, K15 / K1500 Todos Exc. Suspensión Quad y Kit de Levantamiento	
F	87	PICKUP 1/2 TON, V1500 Todos Suspensión Quad Amortiguador Corto; Exc. Kit de Levantamiento	
F	69-86	PICKUP 3/4 TON, K25 / K2500 Todos Exc. Suspensión Quad y Kit de Levantamiento	
F	87	PICKUP 3/4 TON, V2500 Todos Suspensión Quad Amortiguador Corto; Exc. Kit de Levantamiento	
F	69-86	SUBURBAN 1/2 TON, V1500 Todos Suspensión Quad Amortiguador Corto; Exc. Kit de Levantamiento	
F	69-86	SUBURBAN 3/4 TON, K25 / K2500 Todos Exc. Suspensión Quad y Kit de Levantamiento	
F	87-91	SUBURBAN 3/4 TON, V2500 Todos Suspensión Quad Amortiguador Corto; Exc. Kit de Levantamiento	
<b>81147</b>	A		
R	83-93	DODGE PICKUP, RAM 50 4x2 Tracción trasera	
R	55	FORD F SERIES Todos F-100	
F	48-52	F SERIES Todos F-1, F-2 & F-3	
R	65	PICKUP 1/2 TON, F-100 Todos Con Resortes de Hojas Delanteros	
R	61-64	PICKUP 1/2 TON, F-100 Todos	
R	61-66	PICKUP 1 TON, F-350 / SUPERDUTY Todos Hasta PBV 8000#	
R	61-64	PICKUP 3/4 TON, F-250 / SUPERDUTY Todos	
F	68-75	PICKUP P350 Todos Hasta PBV 8000#	
F	75-76	PICKUP P400 Todos Hasta PBV 8000#	
R	68	INTERNATIONAL 908B Todos	
R	68	908C Todos	
R	68	1000B Todos	
R	68	1000C Todos	
F	68	1100B Todos Exc. Travelette c/ base de rueda de 166"	

# Lista numérica

Amort.	POP	No. Alternativo	Montaje Accesorio
Pos.	Año	Aplicación	
<b>81147</b>	A	-continued	
R	68	1100B Todos Exc. Travelette c/ base de rueda de 166"	
F	68	1100C Todos Exc. Travelette c/ base de rueda de 166"	
R	68	1100C Todos Exc. Travelette c/ base de rueda de 166"	
F	68	1200B Todos Exc. Travelette c/ base de rueda de 166"	
R	68	1200B Todos Exc. Travelette c/ base de rueda de 166"	
F	68	1200C Todos Exc. Travelette c/ base de rueda de 166"	
R	68	1200C Todos Exc. Travelette c/ base de rueda de 166"	
F	68	1300B Todos Exc. Travelette c/ base de rueda de 166"	
R	68	1300B Todos Exc. Travelette c/ base de rueda de 166"	
F	68	1300C Todos Exc. Travelette c/ base de rueda de 166"	
R	68	1300C Todos Exc. Travelette c/ base de rueda de 166"	
R	68-72	M1100 / M1200 Todos	
R	69	M1400 Todos	
R	65-67	M SERIES VAN Todos	
R	72-83	JEEP CJ5 Todos Exc. Kit de Levantamiento	
R	66-71	CJ5 Todos Exc. 5 Resortes Helicoidales Delanteros y Kit de Levantamiento	
R	73-83	CJ5D	
R	65-71	CJ5D	
R	65-71	CJ5S	
R	66-75	CJ6 Todos Exc. Kit de Levantamiento	
R	65-75	CJ7	
R	76-86	CJ7 Todos Exc. Kit de Levantamiento	
R	66-74	DJ5 Todos Exc. Kit de Levantamiento	
R	66-68	DJ6 Todos	
R	57-60	FC150 Todos	
F	63-65	FC170 Todos	
R	63-65	FC170 Todos	
R	64-66	GLADIATOR Todos	
R	63	GLADIATOR Todos Suspensión Delantera Independiente	
R	70-73	JEEPSTER Todos	
R	81-85	SCRAMBLER / CJ8 Todos	
R	61-67	UNIVERSAL Todos Exc. C.J-3B	
R	86-87	MAZDA B2000 4x2 Tracción trasera	
R	87-93	B2200 4x2 Tracción trasera	
R	87-93	B2600 4x2 Tracción trasera	
R	87-90	MITSUBISHI VAN Todos	
R	98-04	NISSAN FRONTIER 4x2 Tracción trasera Exc. Desert Runner	
R	05-12	PICKUP	
R	95-04	PICKUP 4x2 Tracción trasera	
R	65-94	PICKUP	
R	85-95	TOYOTA PICKUP 4x2 Tracción trasera Exc. 1 Ton	
R	84	PICKUP 4x2 Tracción trasera	
R	70-83	PICKUP 4x2 Tracción trasera Mojave	
R	84-88	VAN Leaf (RearSpringType)	
R	88	VAN WAGON Leaf (FrontSpringType), Leaf (RearSpringType)	
<b>81153</b>	W		140126
F	73-78	DODGE CHARGER Todos	
<b>81164</b>	D		140357
R	87-91	CHEVROLET BLAZER Todos Automóvil Grande; Exc. Suspensión Quad y Kit de Levantamiento	
R	73-86	BLAZER Todos Exc. Kit de Levantamiento	
R	73-86	PICKUP 1/2 TON, C10 Todos	
R	73-86	PICKUP 1/2 TON, K10 Todos Exc. Suspensión Quad y Kit de Levantamiento	
R	87	PICKUP 1/2 TON, R10 Todos	
R	87	PICKUP 1/2 TON, V10 Todos Exc. Suspensión Quad y Kit de Levantamiento	
R	73-74	PICKUP 3/4 TON, C20 Todos Standard Cab Pickup	
R	73-86	PICKUP 3/4 TON, K20 Todos Exc. Suspensión Quad y Kit de Levantamiento	
R	87	PICKUP 3/4 TON, R20 Standard Cab Pickup	

Lista numérica

Amort.	POP	No. Alternativo	Montaje Accesorio
Pos.	Año	Aplicación	
81164	D	-continued	140357
R 87	PICKUP 3/4 TON, V20 Todos Exc.	Suspensión Quad y Kit de Levantamiento	
R 73-86	SUBURBAN 1/2 TON, C10 Todos		
R 75-86	SUBURBAN 1/2 TON, K10 Todos	Exc. Suspensión Quad y Kit de Levantamiento	
R 87-88	SUBURBAN 1/2 TON, R10 Todos		
R 89-91	SUBURBAN 1/2 TON, R1500 Todos		
R 89-91	SUBURBAN 1/2 TON, V1500 Todos	Exc. Kit de Levantamiento	
R 73-86	SUBURBAN 3/4 TON, C20 Todos		
R 73-86	SUBURBAN 3/4 TON, K20 Todos	Exc. Kit de Levantamiento	
R 87-88	SUBURBAN 3/4 TON, R20 Todos		
R 89-91	SUBURBAN 3/4 TON, R2500 Todos		
R 87-88	SUBURBAN 3/4 TON, V20 Todos	Exc. Suspensión Quad y Kit de Levantamiento	
R 89-91	SUBURBAN 3/4 TON, V2500 Todos	Exc. Suspensión Quad y Kit de Levantamiento	
R 73	VAN 1/2 TON, P SERIES Todos		
R 73-78	VAN 3/4 TON, P SERIES Todos		
R 73-91	GMC JIMMY Todos Exc.	Kit de Levantamiento	
R 73-86	PICKUP 1/2 TON, C15 / C1500	Todos	
R 73-86	PICKUP 1/2 TON, K15 / K1500	Todos Exc. Kit de Levantamiento	
R 87	PICKUP 1/2 TON, R1500 Todos		
R 87	PICKUP 1/2 TON, V1500 Todos	Exc. Kit de Levantamiento	
R 75-86	PICKUP 3/4 TON, C25 / C2500 Cab & Chassis		
R 75-86	PICKUP 3/4 TON, C25 / C2500	Standard Cab Pickup	
R 73-86	PICKUP 3/4 TON, K25 / K2500	Todos Exc. Kit de Levantamiento	
R 88-89	PICKUP 3/4 TON, R2500 Todos	Exc. Crew Cab & Bonus Cab	
R 87	PICKUP 3/4 TON, R2500 Cab & Chassis	Exc. Crew Cab & Bonus Cab	
R 87	PICKUP 3/4 TON, R2500 Standard Cab	Pickup Exc. Crew Cab & Bonus Cab	
R 87	PICKUP 3/4 TON, V2500 Todos	Exc. Kit de Levantamiento	
R 73-86	SUBURBAN 1/2 TON, C15 / C1500	Todos	
R 73-86	SUBURBAN 1/2 TON, K15 / K1500	Todos Exc. Kit de Levantamiento	
R 87-91	SUBURBAN 1/2 TON, R1500 Todos		
R 87-91	SUBURBAN 1/2 TON, V1500 Todos	Exc. Kit de Levantamiento	
R 75-86	SUBURBAN 3/4 TON, C25 / C2500	Todos	
R 73-74	SUBURBAN 3/4 TON, C25 / C2500	Todos Exc. Crew Cab & Bonus Cab	
R 73-86	SUBURBAN 3/4 TON, K25 / K2500	Todos Exc. Kit de Levantamiento	
R 87-91	SUBURBAN 3/4 TON, R2500 Todos		
R 87-91	SUBURBAN 3/4 TON, V2500 Todos	Exc. Kit de Levantamiento	
R 73	VAN 1/2 TON, P SERIES Todos		
R 73-78	VAN 3/4 TON, P SERIES Todos		
81174	D		
R 73-86	CHEVROLET PICKUP 1 TON, C30	Todos	
R 88-91	PICKUP 1 TON, C35/3500 Cab & Chassis	Exc. Eje Rígido Delantero HD	
R 87-88	PICKUP 1 TON, R30 Todos		
R 89	PICKUP 1 TON, R3500 Standard Cab	Pickup	
R 73-74	PICKUP 3/4 TON, C20 Todos	Crew Cab Pickup	
R 88	PICKUP 3/4 TON, R20 Todos		
R 87	PICKUP 3/4 TON, R20 Crew Cab	Pickup	
R 89	PICKUP 3/4 TON, R2500 Todos		
R 74-80	VAN 1/2 TON, P SERIES Todos		
R 79-89	VAN 3/4 TON, P SERIES Todos		
R 91	GMC P3500		
R 88-91	PICKUP 1 TON, C35/3500 Cab & Chassis	Exc. Eje Rígido Delantero HD	
R 73-78	PICKUP 1 TON, C35/3500 Todos		
R 87-91	PICKUP 1 TON, R3500 Todos		
R 85-86	PICKUP 3/4 TON, C25 / C2500	Crew Cab Pickup	

Amortiguadores Guardian

Amort.	POP	No. Alternativo	Montaje Accesorio
Pos.	Año	Aplicación	
81174	D	-continued	
R 75-83	PICKUP 3/4 TON, C25 / C2500	Crew Cab Pickup	
R 87-89	PICKUP 3/4 TON, R2500 Crew Cab	Pickup	
R 74-80	VAN 1/2 TON, P SERIES Todos		
R 74-99	VAN 1 TON, P SERIES Todos		
R 73	VAN 1 TON, P SERIES Base	Exc. Chasis Motorhome	
R 79-89	VAN 3/4 TON, P SERIES Todos		
81242	D		140126
R 79-81	FORD B100		
R 74	B100		
R 75-78	B150		
R 66	BRONCO Todos	Toda la serie #830000	
R 73-79	PICKUP 1/2 TON, F-100 4x2	Tracción trasera	
R 70-72	PICKUP 1/2 TON, F-100 Todos	4x2 Tracción trasera	
R 75-79	PICKUP 1/2 TON, F-150 4x2	Tracción trasera	
R 75-79	PICKUP 1 TON, F-350 / SUPERDUTY Extended Cab	Pickup, 4x2 Tracción trasera	
R 74	PICKUP 1 TON, F-350 / SUPERDUTY 4x2	Tracción trasera	
R 75-79	PICKUP 3/4 TON, F-250 / SUPERDUTY Cab & Chassis,	4x2 Tracción trasera	
R 75-79	PICKUP 3/4 TON, F-250 / SUPERDUTY Standard Cab	Pickup, 4x2 Tracción trasera	
R 70-74	PICKUP 3/4 TON, F-250 / SUPERDUTY 4x2	Tracción trasera	
R 75-91	VAN 1/2 TON, ECONOLINE / CLUB	WAGON Todos	
81270	W		140523
F 57-59	FORD F SERIES Todos		
F 60	PICKUP 1/2 TON, F-100 Todos		
F 60	PICKUP 1 TON, F-350 / SUPERDUTY Todos		
F 60	PICKUP 3/4 TON, F-250 / SUPERDUTY Todos		
81285	D		140126
R 85-91	FORD B200		
R 71-76	PICKUP 1/2 TON, F-100 4x4	Exc. Kit de Levantamiento	
R 76-79	PICKUP 1/2 TON, F-150 4x4	Exc. Kit de Levantamiento	
R 75	PICKUP 1/2 TON, F-150 Todos	4x4; Exc. Kit de Levantamiento	
R 79	PICKUP 1 TON, F-350 / SUPERDUTY 4x4		
R 77-79	PICKUP 3/4 TON, F-250 / SUPERDUTY Cab & Chassis,	4x4 Aplica para toda la serie No. Y20001	
R 77-79	PICKUP 3/4 TON, F-250 / SUPERDUTY Standard Cab	Pickup, 4x4 Aplica para toda la serie No. Y20001	
R 75-91	VAN 1 TON, ECONOLINE / CLUB	WAGON / SUPERDUTY Todos	
R 75-91	VAN 3/4 TON, ECONOLINE / CLUB	WAGON / SUPERDUTY Todos	
81318	C		141137
R 87-89	DODGE RAIDER 2.6L 4Cyl L (156)	Exc. Sport Utility	
F 61-67	FORD ECONOLINE Todos		
F 68	VAN 1/2 TON, ECONOLINE / CLUB	WAGON Todos Fabricado antes de Jul/68	
F 68-72	INTERNATIONAL M1100 / M1200	Todos	
F 65-67	M SERIES VAN Todos		
R 81-95	ISUZU PICKUP Todos		
R 86-92	JEEP COMANCHE Todos		
F 66-67	GLADIATOR Todos		
F 64-65	GLADIATOR Todos	Exc. Suspensión Independiente Delantera	
F 68-73	J2500 PICKUP Todos		
F 66-73	WAGONEER Todos		
F 63-65	WAGONEER Todos	Exc. Suspensión Independiente Delantera	
R 00-04	NISSAN FRONTIER Crew Cab	Pickup, 4x2 Tracción trasera con Desert Runner	
R 98-04	FRONTIER 4x4		
R 98-99	FRONTIER 4x2	Tracción trasera Crew Cab con Desert Runner	

Lista numérica

Amort.	POP	No. Alternativo	Montaje Accesorio
Pos.	Año	Aplicación	
81318	C	-continued	141137
R 95-97	PICKUP 4x4		
R 65-93	PICKUP		
R 85-92	TOYOTA PICKUP 4x2	Tracción trasera 1 Ton	
R 80-83	PICKUP 4x4	Exc. Kit de Levantamiento	
81338	W		140873
R 77-78	DODGE CHARGER	Todos	
81342	W		
R 81-93	DODGE PICKUP 1/2 TON, W100	SERIES Todos Exc. Kit de Levantamiento	
R 72-80	PICKUP 1/2 TON, W100	SERIES Todos	
R 81-93	PICKUP 1 TON, W300	SERIES Todos Exc. Suspensión Quad y Kit de Levantamiento	
R 72-80	PICKUP 1 TON, W300	SERIES Todos	
R 81-93	PICKUP 3/4 TON, W200	SERIES Standard Cab Pickup	Exc. Kit de Levantamiento
R 72-80	PICKUP 3/4 TON, W200	SERIES Todos	
R 76-93	RAMCHARGER 4x4		
R 76-81	PLYMOUTH TRAILDUSTER 4x4		
81394	C		140780
F 85-91	FORD B200		
F 78-79	BRONCO Todos	Suspensión Quad; detrás del Eje Delantero; Exc. Kit de Levantamiento	
F 67-77	BRONCO Todos	Desde Serie #830001; Exc. Kit de Levantamiento	
F 66	BRONCO Todos	Exc. Kit de Levantamiento	
F 73-79	PICKUP 1/2 TON, F-100 4x2	Tracción trasera	
F 65-72	PICKUP 1/2 TON, F-100	Todos 4x2 Tracción trasera	
F 75-79	PICKUP 1/2 TON, F-150 4x2	Tracción trasera	
F 75-79	PICKUP 1 TON, F-350 / SUPERDUTY 4x2	Tracción trasera	
F 73-74	PICKUP 1 TON, F-350 / SUPERDUTY Todos		
F 67-72	PICKUP 1 TON, F-350 / SUPERDUTY Todos	4x2 Tracción trasera	
F 73-79	PICKUP 3/4 TON, F-250 / SUPERDUTY 4x2	Tracción trasera	
F 65-72	PICKUP 3/4 TON, F-250 / SUPERDUTY Todos	4x2 Tracción trasera	
F 75-91	VAN 1 TON, ECONOLINE / CLUB	WAGON / SUPERDUTY Todos	
F 75-91	VAN 3/4 TON, ECONOLINE / CLUB	WAGON / SUPERDUTY Todos	
81446	B		141041
F 92-96	CADILLAC COMMERCIAL	CHASSIS 4x2 Tracción trasera	
F 77-84	COMMERCIAL CHASSIS	Todos	
F 94-96	CHEVROLET IMPALA	Todos Exc. Modelos Policía y Taxi	
F 65-85	IMPALA	Todos Exc. Modelos Policía y Taxi	
F 93-02	FORD CROWN VICTORIA	Base Exc. Modelos Policía y Taxi	
F 93-02	CROWN VICTORIA LX	Exc. Modelos Policía y Taxi	
F 93-02	CROWN VICTORIA S	Exc. Modelos Policía y Taxi	
F 02	CROWN VICTORIA LWB	Exc. Modelos Policía y Taxi	
F 92	CROWN VICTORIA	Todos Exc. Modelos Policía y Taxi	
F 87-91	LTD / COUNTRY SEDAN / COUNTRY SQUIRE / CROWN	VICTORIA Todos	
81469	W		
R 51-61	PLYMOUTH SUBURBAN	Todos	
81478	A		140857
F 81-95	ISUZU PICKUP 4x2	Tracción trasera	
F 04-12	NISSAN PICKUP		
F 95-97	PICKUP 4x4		
F 65-94	PICKUP		
81482	B		
R 05	CHEVROLET BLAZER	Base, 4x4	

# Lista numérica

Amort.	POP	No. Alternativo	Montaje Accesorio
Pos.	Año	Aplicación	
<b>81482</b>	B	-continued	
R	05	BLAZER Base, 4x2 Tracción trasera	
R	96-04	BLAZER LS, 4x4	
R	96-04	BLAZER LS, 4x2 Tracción trasera	
R	95-02	BLAZER LT, 4x2 Tracción trasera	
R	95-01	BLAZER LT, 4x4	
R	95-99	BLAZER Base, 4x4	
R	95-99	BLAZER Base, 4x2 Tracción trasera	
R	95-97	BLAZER Deluxe, 4x2 Tracción trasera	
R	83-94	BLAZER, S MODELS Todos	
R	98-04	S10 LS, 4x4	
R	99-03	S10 Base, 4x4	
R	99-03	S10 LS, 4x2 Tracción trasera	
R	98-03	S10 Base, 4x2 Tracción trasera	
R	94-97	S10 LS	
R	82-97	S10 Base	
R	92-93	S10 EL	
R	83-92	S10 Tahoe	
R	88-90	S10 Durango	
R	82-86	S10 Durango	
R	92-05	GMC JIMMY Todos	
R	83-91	S15 JIMMY Todos	
R	82-04	SONOMA / S15 Todos	
R	91	SYCLONE Todos	
R	92-93	TYPHOON Todos	
<b>81484</b>	W	141137	
R	73-74	FORD B100	
R	78-79	BRONCO Todos Exc. Kit de Levantamiento	
R	66-77	BRONCO Todos Desde Serie #830001; Exc. Kit de Levantamiento	
R	65-78	F-100	
R	67-78	F-350 PICKUP	
R	65-69	PICKUP 1/2 TON, F-100 Todos 4x2 Tracción trasera	
R	75-79	PICKUP 1 TON, F-350 / SUPERDUTY Standard Cab Pickup, 4x2 Tracción trasera	
R	73-74	PICKUP 1 TON, F-350 / SUPERDUTY Todos	
R	75-79	PICKUP 3/4 TON, F-250 / SUPERDUTY Extended Cab Pickup, 4x2 Tracción trasera	
R	65-74	PICKUP 3/4 TON, F-250 / SUPERDUTY 4x2 Tracción trasera Supercab	
R	69-74	VAN 1/2 TON, ECONOLINE / CLUB WAGON Todos	
R	68	VAN 1/2 TON, ECONOLINE / CLUB WAGON Todos A finales de 1968	
R	69-74	VAN 1 TON, ECONOLINE / CLUB WAGON / SUPERDUTY Todos	
R	68	VAN 1 TON, ECONOLINE / CLUB WAGON / SUPERDUTY Todos A finales de 1968	
R	69-74	VAN 3/4 TON, ECONOLINE / CLUB WAGON / SUPERDUTY Todos	
R	68	VAN 3/4 TON, ECONOLINE / CLUB WAGON / SUPERDUTY Todos A finales de 1968	
R	76-83	JEEP CHEROKEE Todos	
F	74-83	CHEROKEE Todos	
F	82-83	CJ5 Todos Exc. Kit de Levantamiento	
F	82-86	CJ5D	
F	82-86	CJ7	
F	82-86	CJ7 Todos	
F	82-86	CJ7 Todos Exc. Kit de Levantamiento	
R	67	GLADIATOR Todos	
F	84-91	GRAND WAGONEER Todos	
R	84-91	GRAND WAGONEER Todos	
F	74-88	J10 PICKUP Todos	
R	74-88	J10 PICKUP Todos	
F	74-88	J20 PICKUP Todos	
R	74-88	J20 PICKUP Todos	
R	68-73	J2500 PICKUP Todos	
F	82-85	SCRAMBLER / CJ8 Todos	
R	76-83	WAGONEER Todos	
F	74-83	WAGONEER Todos	
<b>81490</b>	B	140780	
F	82-85	FORD B150	
F	92	B200	
F	97	BRONCO	
F	80-96	BRONCO Todos Con o sin Suspensión Quad detrás del Eje Delantero; Exc. Kit de Levantamiento	
F	89	BRONCO II Todos Fab. hasta 2/89; Vehículos con perno 10mm & 12mm en montaje inferior trasero	

# Amortiguadores Guardian

Amort.	POP	No. Alternativo	Montaje Accesorio
Pos.	Año	Aplicación	
<b>81490</b>	B	-continued	
F	84-88	BRONCO II Todos Con Perno de 10mm en Montaje Inferior Trasero	
F	86-90	F-200	
F	80-83	PICKUP 1/2 TON, F-100 4x2 Tracción trasera	
F	80-96	PICKUP 1/2 TON, F-150 4x4 Con o sin Suspensión Quad detrás del Eje Delantero; Exc. Kit de Levantamiento	
F	80-96	PICKUP 1/2 TON, F-150 4x2 Tracción trasera	
F	99-00	PICKUP 1 TON, F-350 / SUPERDUTY 4x2 Tracción trasera	
F	80-97	PICKUP 1 TON, F-350 / SUPERDUTY 4x2 Tracción trasera	
F	97	PICKUP 3/4 TON, F-250 / SUPERDUTY 4x2 Tracción trasera PBV arriba de 8500#	
F	80-96	PICKUP 3/4 TON, F-250 / SUPERDUTY 4x2 Tracción trasera	
F	87-89	RANGER Todos Exc. Opción High Ryder	
F	83-86	RANGER Todos	
<b>81492</b>	D	140629	
R	71-82	CHEVROLET IMPALA Wagon	
<b>81495</b>	C	141150	
R	92-02	FORD CROWN VICTORIA Todos	
R	87-91	LTD / COUNTRY SEDAN / COUNTRY SQUIRE / CROWN VICTORIA Todos	
<b>81496</b>	W		
F	87-91	CHEVROLET BLAZER 4x4 Automóvil Grande; Suspensión Quad Amortiguador Largo; Exc. Kit de Levantamiento	
F	81-86	BLAZER 4x4 Suspensión Quad Amortiguador Largo; Exc. Kit de Levantamiento	
F	81-86	PICKUP 1/2 TON, K10 Todos Suspensión Quad Amortiguador Largo; Exc. Kit de Levantamiento	
F	87	PICKUP 1/2 TON, V10 Todos Suspensión Quad Amortiguador Largo; Exc. Kit de Levantamiento	
F	81-86	PICKUP 3/4 TON, K20 Todos Suspensión Quad Amortiguador Largo; Exc. Kit de Levantamiento	
F	87	PICKUP 3/4 TON, V20 Todos Suspensión Quad Amortiguador Largo; Exc. Kit de Levantamiento	
F	81-86	SUBURBAN 1/2 TON, K10 Todos Suspensión Quad Amortiguador Largo; Exc. Kit de Levantamiento	
F	87-88	SUBURBAN 1/2 TON, V10 Todos Suspensión Quad Amortiguador Largo; Exc. Kit de Levantamiento	
F	89-91	SUBURBAN 3/4 TON, V2500 Todos Suspensión Quad Amortiguador Largo; Exc. Kit de Levantamiento	
R	78-95	VAN 1/2 TON, G / EXPRESS Todos	
R	78-95	VAN 1 TON, G / EXPRESS Cutaway Van	
R	78-95	VAN 3/4 TON, G / EXPRESS Todos Exc. PBV 8600 #	
R	99-03	DODGE VAN 1/2 TON, A / B SERIES / RAM 109.3 (WheelBase) Exc. PBV 7000#	
R	81-98	VAN 1/2 TON, A / B SERIES / RAM 109.6 (WheelBase) Exc. PBV 7000#	
R	71-80	VAN 1/2 TON, A / B SERIES / RAM Todos	
R	99-03	VAN 1 TON, A / B SERIES / RAM Todos	
R	95-98	VAN 1 TON, A / B SERIES / RAM Todos Exc. Eje Delantero 4000#	
R	71-94	VAN 1 TON, A / B SERIES / RAM Todos	
R	71-03	VAN 3/4 TON, A / B SERIES / RAM Todos	
R	74-80	VAN, CB300 Todos	
F	73-91	GMC JIMMY 4x4 Suspensión Quad Amortiguador Largo; Exc. Kit de Levantamiento	

# Lista numérica

Amort.	POP	No. Alternativo	Montaje Accesorio
Pos.	Año	Aplicación	
<b>81496</b>	W	-continued	
F	81-86	PICKUP 1/2 TON, K15 / K1500 Todos Suspensión Quad Amortiguador Largo; Exc. Kit de Levantamiento	
F	87	PICKUP 1/2 TON, V1500 Todos Suspensión Quad Amortiguador Largo; Exc. Kit de Levantamiento	
F	87-88	PICKUP 1 TON, V3000 / V3500 Todos Suspensión Quad Amortiguador Largo; Exc. Kit de Levantamiento	
F	81-86	PICKUP 3/4 TON, K25 / K2500 Todos Suspensión Quad Amortiguador Largo; Exc. Kit de Levantamiento	
F	87	PICKUP 3/4 TON, V2500 Todos Suspensión Quad Amortiguador Largo; Exc. Kit de Levantamiento	
F	81-86	SUBURBAN 1/2 TON, K15 / K1500 Todos Suspensión Quad Amortiguador Largo; Exc. Kit de Levantamiento	
F	87-91	SUBURBAN 1/2 TON, V1500 Todos Suspensión Quad Amortiguador Largo; Exc. Kit de Levantamiento	
F	81-86	SUBURBAN 3/4 TON, K25 / K2500 Todos Suspensión Quad Amortiguador Largo; Exc. Kit de Levantamiento	
F	87-91	SUBURBAN 3/4 TON, V2500 Todos Suspensión Quad Amortiguador Largo; Exc. Kit de Levantamiento	
R	78-95	VAN 1/2 TON, G / SAVANNA Todos	
R	85-96	VAN 1 TON, G / SAVANNA Extended Cargo Van	
R	85-96	VAN 1 TON, G / SAVANNA Extended Passenger Van	
R	79-96	VAN 1 TON, G / SAVANNA Standard Cargo Van	
R	79-96	VAN 1 TON, G / SAVANNA Standard Passenger Van	
R	78	VAN 1 TON, G / SAVANNA Cutaway Van	
R	78-95	VAN 3/4 TON, G / SAVANNA Todos Exc. PBV 8600 #	
R	74-83	PLYMOUTH VAN 1/2 TON, PB SERIES Todos	
R	74-83	VAN 1 TON, PB SERIES Todos	
R	74-83	VAN 3/4 TON, PB SERIES Todos	
<b>81507</b>	B	140857	
F	81-95	ISUZU PICKUP 4x4	
F	98-04	NISSAN FRONTIER 4x2 Tracción trasera Exc. Desert Runner	
F	95-97	PICKUP 4x2 Tracción trasera	
F	65-93	PICKUP	
<b>81510</b>	C		
R	65-66	FORD F-350 PICKUP	
R	80-96	PICKUP 1/2 TON, F-150 4x4 Exc. Kit de Levantamiento	
R	86-97	PICKUP 1 TON, F-350 / SUPERDUTY 4x4 Doble Rodada Trasera	
R	82-85	PICKUP 1 TON, F-350 / SUPERDUTY 4x4 Montaje Inferior Delantero Tipo Abrazadera Exc. Doble Rodado o Kit de Levantamiento	
R	80-81	PICKUP 1 TON, F-350 / SUPERDUTY 4x4 Doble Rodada Trasera	
R	97	PICKUP 3/4 TON, F-250 / SUPERDUTY 4x4 PBV arriba de 8500#	
R	86-96	PICKUP 3/4 TON, F-250 / SUPERDUTY 4x4	
R	82-85	PICKUP 3/4 TON, F-250 / SUPERDUTY 4x4 Montaje Inferior Delantero Tipo Abrazadera Exc. Doble Rodado o Kit de Levantamiento	
R	80-81	PICKUP 3/4 TON, F-250 / SUPERDUTY 4x4	
<b>81514</b>	W	140629	
R	92-96	CADILLAC COMMERCIAL CHASSIS 4x2 Tracción trasera	
R	77-84	COMMERCIAL CHASSIS Todos	
R	94-96	CHEVROLET IMPALA Todos	
R	83-85	IMPALA Todos	
R	65-82	IMPALA Sedan	
R	74-81	IMPALA Coupe	
R	73	IMPALA Hardtop	

**Lista numérica**

Amort.	POP	No. Alternativo	Montaje Accesorio
Pos.	Año	Aplicación	
<b>81516</b>	B		
F 05		<b>CHEVROLET</b> BLAZER Base, 4x4	
F 96-04		BLAZER LS, 4x4	
F 95-01		BLAZER LT, 4x4	
F 95-99		BLAZER Base, 4x4	
F 83-94		BLAZER, S MODELS 4x4	
F 94-04		S10 LS, 4x4	
F 83-03		S10 Base, 4x4	
F 92-93		S10 EL, 4x4	
F 83-92		S10 Tahoe, 4x4	
F 88-90		S10 Durango, 4x4	
F 83-86		S10 Durango, 4x4	
F 92-05		<b>GMC</b> JIMMY 4x4	
F 83-91		S15 JIMMY 4x4	
F 83-04		SONOMA / S15 4x4	
F 91		SYCLONE Todos	
F 92-93		TYPHOON Todos	

<b>81538</b>	W		
R 87-93		<b>DODGE</b> PICKUP, RAM 50 4x4	

<b>81539</b>	C		
R 89		<b>FORD</b> BRONCO II Todos Fab. hasta 2/89; Vehículos con perno 10mm & 12mm en montaje inferior trasero	
R 84-88		BRONCO II Todos Con Perno de 10mm en Montaje Inferior Trasero	
R 89		RANGER 4x2 Tracción trasera Fab. hasta 2/89; Vehículos con perno 10mm & 12mm en montaje inferior trasero	
R 83-88		RANGER 4x2 Tracción trasera	

<b>81540</b>	C		
R 83-89		<b>FORD</b> RANGER 4x4	

<b>81541</b>	A	140455	
F 85-95		<b>TOYOTA</b> PICKUP 4x2 Tracción trasera Exc. 1 Ton	
F 84		PICKUP 4x2 Tracción trasera	
F 93-98		T100 4x2 Tracción trasera	

<b>81542</b>	W	140524	
R 84-89		<b>TOYOTA</b> VAN Coil (RearSpringType)	
R 88		VAN WAGON Coil (FrontSpringType), Coil (RearSpringType)	

<b>81548</b>	B	141353	
F 84-01		<b>JEEP</b> CHEROKEE Todos	
F 86-92		COMANCHE Todos	
F 92		GRAND CHEROKEE	
F 93-98		GRAND CHEROKEE Todos	
F 84-90		WAGONEER Todos	

<b>81549</b>	C		
R 84-01		<b>JEEP</b> CHEROKEE Todos	
R 84-90		WAGONEER Todos	

<b>81553</b>	B	140524	
F 86-87		<b>MAZDA</b> B2000 4x2 Tracción trasera	
F 87-93		B2200 4x2 Tracción trasera	
F 87-93		B2600 4x2 Tracción trasera	

<b>81581</b>	D		
R 90-05		<b>CHEVROLET</b> ASTRO Todos	
R 85-89		ASTRO 4x2 Tracción trasera	
R 90-05		<b>GMC</b> SAFARI Todos	
R 85-89		SAFARI 4x2 Tracción trasera	
R 86-89		<b>VOLKSWAGEN</b> VANAGON 4x4	

<b>81582</b>	C	140126	
F 86-97		<b>FORD</b> AEROSTAR 4x2 Tracción trasera	

<b>81583</b>	D		
R 86-88		<b>FORD</b> AEROSTAR 4x2 Tracción trasera	
R 87-95		<b>JEEP</b> WRANGLER YJ (Código plataforma del fabricante)	

<b>81667</b>	B		
R 88-99		<b>CHEVROLET</b> PICKUP 1/2 TON, C15 / C1500 Todos	
R 88-99		PICKUP 1/2 TON, K15 / K1500 Todos	
R 01-03		PICKUP 1 TON, C35/3500 Base Eje Delantero Rígido HD	
R 88-00		PICKUP 1 TON, C35/3500 Extended Cab Pickup Eje Delantero Rígido HD	
R 88-00		PICKUP 1 TON, C35/3500 Standard Cab Pickup Eje Delantero Rígido HD	
R 88-00		PICKUP 1 TON, K35 / K3500 Todos	
R 88-00		PICKUP 3/4 TON, C25 / C2500 Todos	

**Amortiguadores Guardian**

Amort.	POP	No. Alternativo	Montaje Accesorio
Pos.	Año	Aplicación	
<b>81667</b>	B	-continued	
R 88-00		PICKUP 3/4 TON, K25 / K2500 Todos	
R 01-02		<b>GMC</b> C3500	
R 88-99		PICKUP 1/2 TON, C15 / C1500 Todos	
R 88-99		PICKUP 1/2 TON, K15 / K1500 Todos	
R 88-00		PICKUP 1 TON, C35/3500 Extended Cab Pickup Eje Delantero Rígido HD	
R 88-00		PICKUP 1 TON, C35/3500 Standard Cab Pickup Eje Delantero Rígido HD	
R 88-00		PICKUP 1 TON, K35 / K3500 Todos	
R 88-00		PICKUP 3/4 TON, C25 / C2500 Todos	
R 88-00		PICKUP 3/4 TON, K25 / K2500 Todos	

<b>81668</b>	B	141277	
F 88-99		<b>CHEVROLET</b> PICKUP 1/2 TON, C15 / C1500 Todos	
F 92-00		PICKUP 1 TON, C35/3500 Todos Eje Delantero Rígido HD	
F 88-91		PICKUP 1 TON, C35/3500 Extended Cab Pickup Eje Delantero Rígido HD	
F 88-91		PICKUP 1 TON, C35/3500 Standard Cab Pickup Eje Delantero Rígido HD	
F 88-00		PICKUP 3/4 TON, C25 / C2500 Todos	
F 92-99		SUBURBAN 1/2 TON, C15 / C1500 Todos	
F 92-99		SUBURBAN 3/4 TON, C25 / C2500 Todos	
F 95-00		TAHOE 4x2 Tracción trasera Old Body Style	
F 88-99		<b>GMC</b> PICKUP 1/2 TON, C15 / C1500 Todos	
F 88-00		PICKUP 1 TON, C35/3500 Todos Eje Delantero Rígido HD	
F 88-00		PICKUP 3/4 TON, C25 / C2500 Todos	
F 92-99		SUBURBAN 1/2 TON, C15 / C1500 Todos	
F 92-99		SUBURBAN 3/4 TON, C25 / C2500 Todos	
F 92-99		YUKON 4x2 Tracción trasera	

<b>81676</b>	W		
R 55		<b>FORD</b> F SERIES Todos F250	
R 53-54		F SERIES Todos	
R 48-52		F SERIES Todos F-1, F-2 & F-3	
R 53-55		PICKUP 1/2 TON, F-100 Todos Exc. Heavy Duty	
R 53-55		PICKUP 1 TON, F-350 / SUPERDUTY Todos Exc. Heavy Duty	
R 53-55		PICKUP 3/4 TON, F-250 / SUPERDUTY Todos Exc. Heavy Duty	
R 74		<b>JEEP</b> CHEROKEE Todos	
F 66-71		CJ5 Todos Resorte Frontal de 5 Hojas Exc. Kit de Levantamiento	
R 66-71		CJ5 Todos Resorte Frontal de 5 Hojas Exc. Kit de Levantamiento	
F 65-71		CJ5D	
F 65-71		CJ5S	
F 66-71		CJ6 Todos Resorte Frontal de 5 Hojas Exc. Kit de Levantamiento	
R 66-71		CJ6 Todos Resorte Frontal de 5 Hojas Exc. Kit de Levantamiento	
F 61-67		DISPATCHER Todos	
R 61-67		DISPATCHER Todos	
R 61-65		FC150 Todos	
F 61-67		UNIVERSAL Todos Resorte Frontal de 5 Hojas Exc. Kit de Levantamiento	
R 61-67		UNIVERSAL Todos Resorte Frontal de 5 Hojas Exc. Kit de Levantamiento	
R 63-74		WAGONEER Todos	
F 63-65		WAGONEER Todos Suspensión Delantera Independiente	

<b>81691</b>	W	141353	
F 87-95		<b>JEEP</b> WRANGLER YJ (Código plataforma del fabricante)	

<b>81694</b>	D	140780	
F 75-78		<b>FORD</b> B150	
F 75-91		VAN 1/2 TON, ECONOLINE / CLUB WAGON Todos	

<b>81710</b>	C		
R 82-85		<b>FORD</b> B150	
R 80-96		BRONCO Todos Exc. Kit de Levantamiento	

**Lista numérica**

Amort.	POP	No. Alternativo	Montaje Accesorio
Pos.	Año	Aplicación	
<b>81710</b>	C	-continued	
R 86-90		F-200	
R 99-00		F-350 PICKUP	
R 80-83		PICKUP 1/2 TON, F-100 4x2 Tracción trasera	
R 80-84		PICKUP 1/2 TON, F-150 4x2 Tracción trasera	
R 90-97		PICKUP 1/2 TON, F SUPERDUTY Todos	
R 80-97		PICKUP 1 TON, F-350 / SUPERDUTY 4x2 Tracción trasera Doble Rodada Trasera	

<b>81713</b>	C	140800	
F 85-05		<b>CHEVROLET</b> ASTRO 4x2 Tracción trasera	
F 83-85		IMPALA Todos Modelos Policía y Taxi	
F 71-82		IMPALA Sedan Modelos Policía y Taxi	
F 96-02		VAN 1/2 TON, G / EXPRESS Todos	
F 97-02		VAN 1 TON, G / EXPRESS Todos	
F 96-02		VAN 3/4 TON, G / EXPRESS Todos Exc. PBV 8600 #	
F 93-02		<b>FORD</b> CROWN VICTORIA Police Interceptor Modelos Policía y Taxi	
F 85-05		<b>GMC</b> SAFARI 4x2 Tracción trasera	
F 96-02		VAN 1/2 TON, G / SAVANNA 4x2 Tracción trasera	
F 96-02		VAN 1 TON, G / SAVANNA Todos	
F 96-02		VAN 3/4 TON, G / SAVANNA Todos Exc. PBV 8600 #	

<b>81714</b>	C	140455	
F 87-93		<b>DODGE</b> PICKUP, RAM 50 4x2 Tracción trasera	
F 83-86		PICKUP, RAM 50 Todos	

<b>81726</b>	D		
F 99-00		<b>CADILLAC</b> ESCALADE Todos	
F 90-05		<b>CHEVROLET</b> ASTRO AWD	
F 92-94		BLAZER 4x4 Automóvil Grande	
F 88-00		PICKUP 1 TON, K35 / K3500 Todos	
F 88-00		PICKUP 3/4 TON, K25 / K2500 Todos	
F 92-99		SUBURBAN 1/2 TON, K15 / K1500 Todos	
F 92-99		SUBURBAN 3/4 TON, K25 / K2500 Todos	
F 95-00		TAHOE 4x4 Old Body Style	
F 88-00		<b>GMC</b> PICKUP 1 TON, K35 / K3500 Todos	
F 88-00		PICKUP 3/4 TON, K25 / K2500 Todos	
F 90-05		SAFARI AWD	
F 92-99		SUBURBAN 1/2 TON, K15 / K1500 Todos	
F 92-99		SUBURBAN 3/4 TON, K25 / K2500 Todos	
F 92-99		YUKON 4x4	
F 99		YUKON Denali	

<b>81727</b>	W		
R 90-97		<b>FORD</b> AEROSTAR Todos	
R 89		AEROSTAR 4x2 Tracción trasera	

<b>81730</b>	B		
R 90		<b>FORD</b> BRONCO II Todos	
R 89		BRONCO II Todos Fab. desde 2/89; Vehículos con perno de 12mm en montaje inferior trasero	
R 90-97		RANGER 4x2 Tracción trasera	
R 89		RANGER 4x2 Tracción trasera Fab. desde 2/89; Vehículos con perno de 12mm en montaje inferior trasero	
R 94-97		<b>MAZDA</b> B2300 4x2 Tracción trasera	
R 96		B3000 4x2 Tracción trasera	
R 94		B3000 4x2 Tracción trasera	

<b>81744</b>	A	140780	
F 90		<b>FORD</b> BRONCO II Todos	
F 91-94		EXPLORER Todos	
F 90-97		RANGER Todos	
F 92-11		VAN 1/2 TON, ECONOLINE / CLUB WAGON Todos	
F 08-11		VAN 1 TON, ECONOLINE / CLUB WAGON / SUPERDUTY Todos	
F 07		VAN 1 TON, ECONOLINE / CLUB WAGON / SUPERDUTY Todos Exc. Paquete de Ambulancia & Manejo	
F 92-06		VAN 1 TON, ECONOLINE / CLUB WAGON / SUPERDUTY Todos	
F 92-11		VAN 3/4 TON, ECONOLINE / CLUB WAGON / SUPERDUTY Todos	
F 94-97		<b>MAZDA</b> B2300 Todos	
F 94-96		B3000 4x2 Tracción trasera	

Lista numérica

Amort.	POP	No. Alternativo	Montaje Accesorio
Pos.	Año	Aplicación	
<b>81744</b>	A	-continued 140780	
F	96	B3000	4x4
F	94	B3000	4x4
F	94-97	B4000	Todos
<b>81750</b>	B	140455	
F	05	<b>CHEVROLET</b> BLAZER Base, 4x2 Tracción trasera	
F	96-04	BLAZER LS, 4x2 Tracción trasera	
F	95-02	BLAZER LT, 4x2 Tracción trasera	
F	95-99	BLAZER Base, 4x2 Tracción trasera	
F	95-97	BLAZER Deluxe, 4x2 Tracción trasera	
F	83-94	BLAZER, S MODELS 4x2 Tracción trasera	
F	94-03	S10 LS, 4x2 Tracción trasera	
F	82-03	S10 Base, 4x2 Tracción trasera	
F	92-93	S10 EL, 4x2 Tracción trasera	
F	83-92	S10 Tahoe, 4x2 Tracción trasera	
F	88-90	S10 Durango, 4x2 Tracción trasera	
F	82-86	S10 Durango, 4x2 Tracción trasera	
F	92-04	<b>GMC</b> JIMMY 4x2 Tracción trasera	
F	83-91	S15 JIMMY 4x2 Tracción trasera	
F	04	SONOMA / S15 Todos 4x2 Tracción trasera	
F	82-03	SONOMA / S15 4x2 Tracción trasera	
F	72-76	<b>MAZDA</b> B1600 Todos	
F	77-78	B1800 Todos	
F	79-84	B2000 Todos	
F	82-84	B2200 Todos	
F	70-83	<b>TOYOTA</b> PICKUP 4x2 Tracción trasera Mojave	
<b>81789</b>	C		
R	99-00	<b>CADILLAC</b> ESCALADE Todos	
R	92-94	<b>CHEVROLET</b> BLAZER 4x4 Automóvil Grande	
R	92-99	SUBURBAN 1/2 TON, C15 / C1500 Todos	
R	92-99	SUBURBAN 1/2 TON, K15 / K1500 Todos	
R	92-99	SUBURBAN 3/4 TON, C25 / C2500 Todos	
R	92-99	SUBURBAN 3/4 TON, K25 / K2500 Todos	
R	95-00	TAHOE Todos Old Body Style	
R	96-11	VAN 1/2 TON, G / EXPRESS Todos	
R	10-12	VAN 1 TON, G / EXPRESS Todos	
R	97-06	VAN 1 TON, G / EXPRESS Todos	
R	07-09	VAN 3/4 TON, G / EXPRESS Todos	
R	96-02	VAN 3/4 TON, G / EXPRESS Todos Exc. PBV 8600 #	
R	92-99	<b>GMC</b> SUBURBAN 1/2 TON, C15 / C1500 Todos	
R	92-99	SUBURBAN 1/2 TON, K15 / K1500 Todos	
R	92-99	SUBURBAN 3/4 TON, C25 / C2500 Todos	
R	92-99	SUBURBAN 3/4 TON, K25 / K2500 Todos	
R	96-11	VAN 1/2 TON, G / SAVANNA 4x2 Tracción trasera	
R	97-02	VAN 1 TON, G / SAVANNA Todos	
R	96-02	VAN 3/4 TON, G / SAVANNA Todos Exc. PBV 8600 #	
R	92-99	YUKON Todos	
R	99	YUKON Denali, 4x4	
<b>81821</b>	D	140719	
F	87-90	<b>FORD</b> F-200	
F	01	F-250	
F	65-78	F-350 PICKUP	
F	86-97	PICKUP 1 TON, F-350 / SUPERDUTY 4x4	
F	97	PICKUP 3/4 TON, F-250 / SUPERDUTY 4x4 PBV arriba de 8500#	
F	87-96	PICKUP 3/4 TON, F-250 / SUPERDUTY 4x4	
<b>81823</b>	C	140719	
R	91-94	<b>FORD</b> EXPLORER Todos	
<b>81825</b>	W		
F	81-93	<b>DODGE</b> PICKUP 1/2 TON, W100 SERIES Todos Exc. Kit de Levantamiento	
F	61-80	PICKUP 1/2 TON, W100 SERIES Todos	
F	81-93	PICKUP 1 TON, W300 SERIES Todos Exc. Suspensión Quad y Kit de Levantamiento	
F	61-80	PICKUP 1 TON, W300 SERIES Todos	
R	61-71	PICKUP 1 TON, W300 SERIES Todos	

Amortiguadores Guardian

Amort.	POP	No. Alternativo	Montaje Accesorio
Pos.	Año	Aplicación	
<b>81825</b>	W	-continued	
F	81-93	PICKUP 3/4 TON, W200 SERIES Standard Cab Pickup Exc. Kit de Levantamiento	
F	69-80	PICKUP 3/4 TON, W200 SERIES Todos	
F	61-67	PICKUP 3/4 TON, W200 SERIES Todos	
F	74-93	RAMCHARGER 4x4	
F	74-81	<b>PLYMOUTH</b> TRAILDUSTER 4x4	
<b>81826</b>	D	140780	
F	90-97	<b>FORD</b> AEROSTAR 4x4	
F	90-97	AEROSTAR AWD	
<b>81828</b>	W	142617	
R	99-02	<b>FORD</b> ECONOLINE WAGON	
R	04-11	VAN 1 TON, ECONOLINE / CLUB WAGON / SUPERDUTY Todos Exc. Paquete de Ambulancia & Manejo	
R	92-05	VAN 1 TON, ECONOLINE / CLUB WAGON / SUPERDUTY Todos	
R	92-11	VAN 3/4 TON, ECONOLINE / CLUB WAGON / SUPERDUTY Todos	
<b>81833</b>	D	140780	
R	92-07	<b>FORD</b> VAN 1/2 TON, ECONOLINE / CLUB WAGON Todos	
<b>81834</b>	D	140126	
F	72-93	<b>DODGE</b> PICKUP 1 TON, D300 SERIES Todos Paquete HD	
F	82-93	PICKUP 3/4 TON, D200 SERIES Todos Paquete HD	
F	75-81	PICKUP 3/4 TON, D200 SERIES 165.0 (WheelBase) Paquete HD	
F	72-74	PICKUP 3/4 TON, D200 SERIES Todos Paquete HD	
F	71-93	VAN 1 TON, A / B SERIES / RAM Todos Con Eje Delantero 4000#	
F	74-80	VAN, CB300 Todos Con Eje Delantero 4000#	
F	74-83	<b>PLYMOUTH</b> VAN 1 TON, PB SERIES Todos Con Eje Delantero 4000#	
<b>81869</b>	C	141353,142592	
F	99-04	<b>JEEP</b> GRAND CHEROKEE Todos	
<b>81870</b>	B	141350	
F	86-95	<b>TOYOTA</b> 4RUNNER Todos	
F	86-95	PICKUP 4x4 Exc. Kit de Levantamiento	
F	93-98	T100 4x4	
<b>81871</b>	B	140149	
R	84-89	<b>TOYOTA</b> 4RUNNER Todos	
R	84-95	PICKUP 4x4 Exc. Kit de Levantamiento	
R	98-04	TACOMA Pre Runner	
R	95-04	TACOMA 4x4	
<b>81872</b>	D	140524	
F	87-90	<b>MINI</b> COOPER VAN Todos	
<b>81873</b>	C		
R	07	<b>CHEVROLET</b> PICKUP 1/2 TON, SILVERADO 1500 Classic Hybrid, 4x2 Tracción trasera Exc. Suspensión Electrónica Ajustable	
R	07	PICKUP 1/2 TON, SILVERADO 1500 Classic LS, 4x2 Tracción trasera Exc. Suspensión Electrónica Ajustable	
R	07	PICKUP 1/2 TON, SILVERADO 1500 Classic LT, 4x2 Tracción trasera Exc. Suspensión Electrónica Ajustable	
R	07	PICKUP 1/2 TON, SILVERADO 1500 Classic SS, 4x2 Tracción trasera Exc. Suspensión Electrónica Ajustable	
R	07	PICKUP 1/2 TON, SILVERADO 1500 Classic WT, 4x2 Tracción trasera Exc. Suspensión Electrónica Ajustable	
R	99-06	PICKUP 1/2 TON, SILVERADO 1500 4x2 Tracción trasera Exc. Suspensión Electrónica Ajustable	
R	00-02	SONORA Todos	
R	94-01	<b>DODGE</b> PICKUP 1/2 TON, RAM 1500 Todos	
R	94-02	PICKUP 1 TON, RAM 3500 4x2 Tracción trasera Exc. Eje Delantero Rígido	

Lista numérica

Amort.	POP	No. Alternativo	Montaje Accesorio
Pos.	Año	Aplicación	
<b>81873</b>	C	-continued	
R	94-03	PICKUP 3/4 TON, RAM 2500 4x4, GAS Exc. PBV 8600 #	
R	94-02	PICKUP 3/4 TON, RAM 2500 4x2 Tracción trasera	
R	95-96	PICKUP 3/4 TON, RAM 2500 4x4, CNG Exc. PBV 8600 #	
R	07	<b>GMC</b> SIERRA 1500 Classic Hybrid, 4x2 Tracción trasera Exc. Suspensión Electrónica Ajustable	
R	07	SIERRA 1500 Classic SL, 4x2 Tracción trasera Exc. Suspensión Electrónica Ajustable	
R	07	SIERRA 1500 Classic SLE, 4x2 Tracción trasera Exc. Suspensión Electrónica Ajustable	
R	07	SIERRA 1500 Classic SLT, 4x2 Tracción trasera Exc. Suspensión Electrónica Ajustable	
R	07	SIERRA 1500 Classic WT, 4x2 Tracción trasera Exc. Suspensión Electrónica Ajustable	
R	99-06	SIERRA 1500 4x2 Tracción trasera Exc. Suspensión Electrónica Ajustable	
<b>81890</b>	B	140719	
R	95-01	<b>FORD</b> EXPLORER Todos Exc. Suspensión de Aire	
R	98	EXPLORER Todos	
R	01-05	EXPLORER SPORT TRAC Todos	
<b>81891</b>	C		
R	93-98	<b>JEEP</b> GRAND CHEROKEE Todos	
<b>81892</b>	C	142700	
R	04	<b>FORD</b> PICKUP 1/2 TON, F-150 4x2 Tracción trasera	
R	00-03	PICKUP 1/2 TON, F-150 Harley-Davidson Edition, 4x2 Tracción trasera	
R	99-03	PICKUP 1/2 TON, F-150 Lariat, 4x2 Tracción trasera	
R	99-03	PICKUP 1/2 TON, F-150 XL, 4x2 Tracción trasera	
R	99-03	PICKUP 1/2 TON, F-150 XLT, 4x2 Tracción trasera	
R	00	PICKUP 1/2 TON, F-150 Base, 4x2 Tracción trasera	
R	97-98	PICKUP 1/2 TON, F-150 4x2 Tracción trasera	
R	97-99	PICKUP 3/4 TON, F-250 / SUPERDUTY 4x2 Tracción trasera Hasta PBV 8500#	
<b>81893</b>	A	142277	
F	95-01	<b>FORD</b> EXPLORER Todos Exc. Suspensión Electrónica Ajustable	
F	01-05	EXPLORER SPORT TRAC Todos	
F	06-11	RANGER 4x2 Tracción trasera, Barra de Torsión (FrontSpringType)	
F	98-11	RANGER 4x4	
F	01-05	RANGER Edge, 4x2 Tracción trasera	
F	03-06	<b>MAZDA</b> B3000 Todos 4x4	
F	98-02	B3000 4x4	
F	98-06	B4000 4x4	
<b>81896</b>	D	140780	
F	94-98	<b>DODGE</b> RAM WAGON	
<b>81897</b>	W	140115	
R	94-98	<b>FORD</b> F-600	
<b>81898</b>	W		
F	95-99	<b>DODGE</b> RAM 6500	
<b>81900</b>	W		
R	94-98	<b>DODGE</b> RAM WAGON	
<b>81905</b>	C		
R	90-97	<b>FORD</b> RANGER 4x4	
R	89	RANGER 4x4 Fab. desde 2/89; Vehículos con perno de 12mm en montaje inferior trasero	
R	95-96	<b>MAZDA</b> B2300 4x4	
R	94-97	B3000 4x4	
R	94-97	B4000 4x4	
<b>81906</b>	W	140921	
R	90-95	<b>TOYOTA</b> 4RUNNER Todos	
<b>81907</b>	W	140169	
R	87-93	<b>MAZDA</b> B2600 4x4	

Lista numérica

Amort.	POP	No. Alternativo	Montaje Accesorio
Pos.	Año	Aplicación	
81908	C		140673
F	01-04	TOYOTA TACOMA S-Runner Exc. Off Road Package	
F	04	TACOMA Base, 4x2 Tracción trasera Exc. Off Road Package	
F	95-03	TACOMA DLX, 4x2 Tracción trasera Exc. Off Road Package	
81912	B		142731
F	97-02	FORD EXPEDITION 4x2 Tracción trasera Exc. Nivelación Nuemática Delantera	
F	97-04	PICKUP 1/2 TON, F-150 4x2 Tracción trasera	
F	97-99	PICKUP 3/4 TON, F-250 / SUPERDUTY 4x2 Tracción trasera Hasta PBV 8500#	
F	98-02	LINCOLN NAVIGATOR 4x2 Tracción trasera	
81913	C		142700
R	97-04	FORD PICKUP 1/2 TON, F-150 4x4 Exc. PBV 7700#	
R	97-99	PICKUP 3/4 TON, F-250 / SUPERDUTY 4x4 Hasta PBV 8500#, Exc. Superduty	
81914	C		142731
F	97-02	FORD EXPEDITION 4x4 Exc. Nivelación Nuemática Delantera	
F	04	PICKUP 1/2 TON, F-150 4x4 Exc. PBV 7700#	
F	97-03	PICKUP 1/2 TON, F-150 4x4	
F	97-99	PICKUP 3/4 TON, F-250 / SUPERDUTY 4x4 Hasta PBV 8500#, Exc. Superduty	
81916	B		141665
F	06-11	FORD RANGER 4x2 Tracción trasera. Coil (FrontSpringType)	
F	98-05	RANGER XL, 4x2 Tracción trasera Exc. Modelos Edge, EV, Splash & Deportivo	
F	98-05	RANGER XLT, 4x2 Tracción trasera Exc. Modelos Edge, EV, Splash & Deportivo	
F	05	RANGER STX, 4x2 Tracción trasera Exc. Modelos Edge, EV, Splash & Deportivo	
F	04	RANGER Tremor, 4x2 Tracción trasera Exc. Modelos Edge, EV, Splash & Deportivo	
F	01-06	MAZDA B2300 4x2 Tracción trasera	
F	98-01	B2500 4x2 Tracción trasera	
F	98-06	B3000 4x2 Tracción trasera	
F	98-04	B4000 4x2 Tracción trasera	
81917	C		
R	06-11	FORD RANGER 4x2 Tracción trasera. Coil (FrontSpringType)	
R	98-05	RANGER XL, 4x2 Tracción trasera Exc. Modelos Edge, EV, Splash & Deportivo	
R	98-05	RANGER XLT, 4x2 Tracción trasera Exc. Modelos Edge, EV, Splash & Deportivo	
R	05	RANGER STX, 4x2 Tracción trasera Exc. Modelos Edge, EV, Splash & Deportivo	
R	04	RANGER Tremor, 4x2 Tracción trasera Exc. Modelos Edge, EV, Splash & Deportivo	
R	98-01	MAZDA B2500 Todos	
R	98-06	B3000 4x2 Tracción trasera	
R	98-04	B4000 4x2 Tracción trasera	
81918	D		
R	06-11	FORD RANGER 4x2 Tracción trasera, Barra de Torsion (FrontSpringType)	
R	98-11	RANGER 4x4	
R	01-05	RANGER Edge, 4x2 Tracción trasera	
R	03-06	MAZDA B3000 Todos 4x4	
R	98-02	B3000 4x4	
R	98-04	B4000 4x4	
81919	D		142731
F	94-01	DODGE PICKUP 1/2 TON, RAM 1500 4x4	
F	99-02	PICKUP 3/4 TON, RAM 2500 4x4 Exc. PBV 8600 #	
F	94-95	PICKUP 3/4 TON, RAM 2500 4x4 Exc. PBV 8600 #	

Amortiguadores Guardian

Amort.	POP	No. Alternativo	Montaje Accesorio
Pos.	Año	Aplicación	
81920	B		141665
F	07	CHEVROLET PICKUP 1/2 TON, SILVERADO 1500 Classic Hybrid, 4x2 Tracción trasera Exc. Suspensión Electrónica Ajustable	
F	07	PICKUP 1/2 TON, SILVERADO 1500 Classic LS, 4x2 Tracción trasera Exc. Suspensión Electrónica Ajustable	
F	07	PICKUP 1/2 TON, SILVERADO 1500 Classic LT, 4x2 Tracción trasera Exc. Suspensión Electrónica Ajustable	
F	07	PICKUP 1/2 TON, SILVERADO 1500 Classic SS, 4x2 Tracción trasera Exc. Suspensión Electrónica Ajustable	
F	07	PICKUP 1/2 TON, SILVERADO 1500 Classic WT, 4x2 Tracción trasera Exc. Suspensión Electrónica Ajustable	
F	99-06	PICKUP 1/2 TON, SILVERADO 1500 4x2 Tracción trasera Exc. Suspensión Electrónica Ajustable	
F	07	GMC SIERRA 1500 Classic Hybrid, 4x2 Tracción trasera Exc. Suspensión Electrónica Ajustable	
F	07	SIERRA 1500 Classic SL, 4x2 Tracción trasera Exc. Suspensión Electrónica Ajustable	
F	07	SIERRA 1500 Classic SLE, 4x2 Tracción trasera Exc. Suspensión Electrónica Ajustable	
F	07	SIERRA 1500 Classic SLT, 4x2 Tracción trasera Exc. Suspensión Electrónica Ajustable	
F	07	SIERRA 1500 Classic WT, 4x2 Tracción trasera Exc. Suspensión Electrónica Ajustable	
F	99-06	SIERRA 1500 4x2 Tracción trasera Exc. Suspensión Electrónica Ajustable	
81921	D		
R	07	CHEVROLET PICKUP 1/2 TON, SILVERADO 1500 Classic Hybrid, 4x4 Estilo Carrocería Clásica y Antigua, Exc. Suspensión Electrónica Ajustable	
R	07	PICKUP 1/2 TON, SILVERADO 1500 Classic LS, 4x4 Estilo Carrocería Clásica y Antigua, Exc. Suspensión Electrónica Ajustable	
R	07	PICKUP 1/2 TON, SILVERADO 1500 Classic LT, 4x4 Estilo Carrocería Clásica y Antigua, Exc. Suspensión Electrónica Ajustable	
R	99-06	PICKUP 1/2 TON, SILVERADO 1500 4x4 Estilo Carrocería Clásica y Antigua, Exc. Suspensión Electrónica Ajustable	
R	05-07	PICKUP 1/2 TON, SILVERADO 1500 HD Todos	
R	01-03	PICKUP 1/2 TON, SILVERADO 1500 HD Todos	
R	77-86	PICKUP 1 TON, K30 Todos	
R	90-91	PICKUP 1 TON, R3500 Todos	
R	89	PICKUP 1 TON, R3500 Cab & Chassis, 4x2 Tracción trasera	
R	89	PICKUP 1 TON, R3500 Crew Cab Pickup, 4x2 Tracción trasera	
R	01-09	PICKUP 1 TON, SILVERADO 3500 Todos	
R	07-10	PICKUP 1 TON, SILVERADO 3500 HD Todos	
R	87-88	PICKUP 1 TON, V30 Todos	
R	89-91	PICKUP 1 TON, V3000 / V3500 Todos	
R	99-08	PICKUP 3/4 TON, SILVERADO 2500 Todos	
R	01-10	PICKUP 3/4 TON, SILVERADO 2500 HD Todos	
R	94-02	DODGE PICKUP 1 TON, RAM 3500 4x4	
R	94-02	PICKUP 1 TON, RAM 3500 4x2 Tracción trasera Eje Delantero Rígido	
R	94-02	PICKUP 3/4 TON, RAM 2500 4x4, DIESEL PBV 8800	
R	77-86	GMC PICKUP 1 TON, K35 / K3500 Todos	

Lista numérica

Amort.	POP	No. Alternativo	Montaje Accesorio
Pos.	Año	Aplicación	
81921	D		-continued
R	87-91	PICKUP 1 TON, V3000 / V3500 Todos	
R	07	SIERRA 1500 Classic Hybrid, 4x4 Estilo Carrocería Clásica y Antigua, Exc. Suspensión Electrónica Ajustable	
R	07	SIERRA 1500 Classic SL, 4x4 Estilo Carrocería Clásica y Antigua, Exc. Suspensión Electrónica Ajustable	
R	07	SIERRA 1500 Classic SLE, 4x4 Estilo Carrocería Clásica y Antigua, Exc. Suspensión Electrónica Ajustable	
R	07	SIERRA 1500 Classic SLT, 4x4 Estilo Carrocería Clásica y Antigua, Exc. Suspensión Electrónica Ajustable	
R	07	SIERRA 1500 Classic WT, 4x4 Estilo Carrocería Clásica y Antigua, Exc. Suspensión Electrónica Ajustable	
R	99-06	SIERRA 1500 4x4 Estilo Carrocería Clásica y Antigua, Exc. Suspensión Electrónica Ajustable	
R	05-07	SIERRA 1500 HD Todos	
R	01-03	SIERRA 1500 HD Todos	
R	99-04	SIERRA 2500 Todos	
R	01-10	SIERRA 2500 HD Todos	
R	01-07	SIERRA 3500 Todos	
R	07-10	SIERRA 3500 HD Todos	
81922	C		141665
F	02-06	CHEVROLET AVALANCHE 1500 Todos Exc. Control de Manejo Electrónico	
F	07	PICKUP 1/2 TON, SILVERADO 1500 Classic Hybrid, 4x4 Estilo Carrocería Clásica y Antigua, Exc. Suspensión Electrónica Ajustable	
F	07	PICKUP 1/2 TON, SILVERADO 1500 Classic WT, 4x4 Estilo Carrocería Clásica y Antigua, Exc. Suspensión Electrónica Ajustable	
F	99-06	PICKUP 1/2 TON, SILVERADO 1500 4x4 Estilo Carrocería Clásica y Antigua, Exc. Suspensión Electrónica Ajustable	
F	00-06	SUBURBAN 1/2 TON, 1500 Todos Exc. Suspensión Z55 Auto Ride	
F	02-06	TAHOE Todos Exc. Suspensión Z55 Auto Ride	
F	00-01	TAHOE Todos Estilo New Body, Exc. Suspensión Z55	
F	07	GMC SIERRA 1500 Classic Hybrid, 4x4 Estilo Carrocería Clásica y Antigua, Exc. Suspensión Electrónica Ajustable	
F	07	SIERRA 1500 Classic SL, 4x4 Estilo Carrocería Clásica y Antigua, Exc. Suspensión Electrónica Ajustable	
F	07	SIERRA 1500 Classic SLE, 4x4 Estilo Carrocería Clásica y Antigua, Exc. Suspensión Electrónica Ajustable	
F	07	SIERRA 1500 Classic SLT, 4x4 Estilo Carrocería Clásica y Antigua, Exc. Suspensión Electrónica Ajustable	
F	07	SIERRA 1500 Classic WT, 4x4 Estilo Carrocería Clásica y Antigua, Exc. Suspensión Electrónica Ajustable	
F	99-06	SIERRA 1500 4x4 Estilo Carrocería Clásica y Antigua, Exc. Suspensión Electrónica Ajustable	
F	00-06	YUKON Todos Exc. Suspensión Z55 Auto Ride	
F	00-06	YUKON XL 1/2 TON Todos Exc. Suspensión Z55 Auto Ride	
F	00-06	YUKON XL 3/4 TON Todos Exc. Suspensión Z55 Auto Ride	
81925	W		141665
F	02-06	CHEVROLET AVALANCHE 2500 Todos Exc. Control de Manejo Electrónico	
F	05-07	PICKUP 1/2 TON, SILVERADO 1500 HD Todos	



### Lista numérica

Amort.	POP	No. Alternativo	Montaje Accesorio
Pos.	Año	Aplicación	
81925	W	-continued	141665
F	01-03	PICKUP 1/2 TON, SILVERADO 1500 HD Todos	
F	01-09	PICKUP 1 TON, SILVERADO 3500 Todos	
F	07-10	PICKUP 1 TON, SILVERADO 3500 HD Todos	
F	05-08	PICKUP 3/4 TON, SILVERADO 2500 Todos	
F	99-04	PICKUP 3/4 TON, SILVERADO 2500 4x4	
F	01-10	PICKUP 3/4 TON, SILVERADO 2500 HD Todos PBV 9200	
F	00-11	SUBURBAN 3/4 TON, 2500 Todos Exc. Suspensión Auto Ride Z55 y QuadraSteer	
F	05-07	GMC SIERRA 1500 HD Todos	
F	01-03	SIERRA 1500 HD Todos	
F	99-04	SIERRA 2500 4x4	
F	01-10	SIERRA 2500 HD Todos	
F	01-07	SIERRA 3500 Todos	
F	07-10	SIERRA 3500 HD Barra de Torsión (FrontSpringType)	
F	00-06	YUKON XL 3/4 TON Todos Exc. Sistema de Autonivelación NIVOMAT	
81926	C		
R	99-04	JEEP GRAND CHEROKEE Todos	
81928	C		143000
F	94-01	DODGE PICKUP 1/2 TON, RAM 1500 4x2 Tracción trasera	
F	94-02	PICKUP 1 TON, RAM 3500 4x2 Tracción trasera Exc. Eje Delantero Rígido	
F	94-02	PICKUP 3/4 TON, RAM 2500 4x2 Tracción trasera	
81929	D		
R	97-06	JEEP WRANGLER TJ (Código plataforma del fabricante)	
81930	D		
R	07-11	CHEVROLET AVALANCHE 1500 Todos Exc. Suspensión Z55 o ZW7	
R	02-06	AVALANCHE 1500 Todos Exc. Control de Manejo Electrónico	
R	02-06	AVALANCHE 2500 Todos Exc. Control de Manejo Electrónico	
R	07-11	SUBURBAN 1/2 TON, 1500 Todos Exc. Suspensión Z55 o ZW7	
R	00-06	SUBURBAN 1/2 TON, 1500 Todos Exc. Suspensión Z55 Auto Ride	
R	00-11	SUBURBAN 3/4 TON, 2500 Todos Exc. Suspensión Auto Ride Z55 y QuadraSteer	
R	07-11	TAHOE Todos Exc. Suspensión Z55 o ZW7	
R	02-06	TAHOE Todos Exc. Suspensión Z55 Auto Ride	
R	00-01	TAHOE Todos Estilo New Body, Exc. Suspensión Z55	
R	07-11	GMC YUKON Todos Exc. Suspensión Z55 o ZW7	
R	00-06	YUKON Todos Exc. Suspensión Z55 Auto Ride	
R	02	YUKON Denali Exc. Suspensión Z55 Auto Ride	
R	00-06	YUKON XL 1/2 TON Todos Exc. Suspensión Z55 Auto Ride	
R	00-06	YUKON XL 3/4 TON Todos Exc. Sistema de Autonivelación NIVOMAT	
81931	D		
R	06-08	DODGE PICKUP 1/2 TON, RAM 1500 Crew Cab Pickup, 4x4	
R	06-08	PICKUP 1/2 TON, RAM 1500 Standard Cab Pickup, 4x4	
R	02-05	PICKUP 1/2 TON, RAM 1500 4x4	
81932	D		
F	02-05	DODGE PICKUP 1/2 TON, RAM 1500 4x4	
81933	C		
F	06-08	DODGE PICKUP 1/2 TON, RAM 1500 Crew Cab Pickup, 4x2 Tracción trasera	
F	06-08	PICKUP 1/2 TON, RAM 1500 Standard Cab Pickup, 4x2 Tracción trasera	
F	02-05	PICKUP 1/2 TON, RAM 1500 4x2 Tracción trasera	

### Amortiguadores Guardian

Amort.	POP	No. Alternativo	Montaje Accesorio
Pos.	Año	Aplicación	
81936	C		
F	97-06	JEEP WRANGLER TJ (Código plataforma del fabricante)	
82001	B		141229
R	73-80	VOLKSWAGEN SAFARI	
F	56-69	TRANSPORTER Todos	
R	56-67	TRANSPORTER Todos	
82003	W		
R	69-72	CHEVROLET BLAZER Todos Resorte Trasero	
R	67-72	PICKUP 1/2 TON, C10 Todos Resorte Trasero	
R	67-72	PICKUP 3/4 TON, C20 Todos Resorte Trasero	
R	67	SUBURBAN 1/2 TON, 1500 Todos Resorte Trasero	
R	68-72	SUBURBAN 1/2 TON, C10 Todos	
R	68-72	SUBURBAN 3/4 TON, C20 Todos	
R	64-66	VAN 1/2 TON, G / EXPRESS Todos	
R	67-72	VAN 1/2 TON, P SERIES Todos	
R	70-72	GMC JIMMY Todos 4x2 Tracción trasera	
R	67-72	PICKUP 1/2 TON, C15 / C1500 Todos Resorte Trasero	
R	67-72	PICKUP 3/4 TON, C25 / C2500 Todos Resorte Trasero	
R	68-72	SUBURBAN 1/2 TON, C15 / C1500 Todos Resorte Trasero	
R	68-72	SUBURBAN 3/4 TON, C25 / C2500 Todos	
R	64-66	VAN 1/2 TON, G / SAVANNA Todos	
R	68-72	VAN 1/2 TON, P SERIES Todos	
82005	B		141147
F	73-80	VOLKSWAGEN SAFARI	
82006	W		
R	69-72	CHEVROLET BLAZER Todos Resorte Trasero de Hojas Múltiples	
R	63-72	PICKUP 1/2 TON, C10 Todos Resorte Trasero de Hojas Múltiples	
R	67-72	PICKUP 1 TON, C30 Todos Exc. Eje Trasero 11,000#	
R	67-72	PICKUP 3/4 TON, C20 Todos Resorte Trasero de Hojas Múltiples	
R	63-66	SUBURBAN 1/2 TON, 1500 Todos	
R	67-77	VAN 1/2 TON, G / EXPRESS Todos	
R	63-66	VAN 1/2 TON, P SERIES Todos	
R	76-77	VAN 1 TON, G / EXPRESS Todos	
R	75	VAN 1 TON, G / EXPRESS 110.0 (WheelBase)	
R	75	VAN 1 TON, G / EXPRESS 125.0 (WheelBase)	
R	71-74	VAN 1 TON, G / EXPRESS Todos	
R	67-77	VAN 3/4 TON, G / EXPRESS Todos	
R	68-72	VAN 3/4 TON, P SERIES Todos	
R	67-72	GMC PICKUP 1/2 TON, C15 / C1500 Todos Resorte Trasero de Hojas Múltiples	
R	67-72	PICKUP 1 TON, C35/3500 Todos Exc. Eje Trasero 11,000#	
R	67-72	PICKUP 3/4 TON, C25 / C2500 Todos Resorte Trasero de Hojas Múltiples	
R	63-65	PICKUP 1500 SERIES Todos	
R	67-77	VAN 1/2 TON, G / SAVANNA Todos	
R	67	VAN 1/2 TON, P SERIES Todos	
R	76-77	VAN 1 TON, G / SAVANNA Todos	
R	75	VAN 1 TON, G / SAVANNA 110.0 (WheelBase)	
R	75	VAN 1 TON, G / SAVANNA 125.0 (WheelBase)	
R	71-74	VAN 1 TON, G / SAVANNA Todos	
R	68-72	VAN 1 TON, P SERIES Todos Exc. Eje Trasero 11,000#	
R	67-77	VAN 3/4 TON, G / SAVANNA Todos	
R	68-72	VAN 3/4 TON, P SERIES Todos	
R	63-65	VAN, PB 1000 SERIES Todos	
82007	W		140349
R	68	FORD E-100 ECONOLINE	
R	61-67	ECONOLINE Todos	
F	68	INTERNATIONAL 908B Todos	
F	68	908C Todos	
F	68	1100B Todos	
F	68	1100C Todos	
F	68	1200B Todos Exc. Travelette c/ base de rueda de 166"	
F	68	1200C Todos Exc. Travelette c/ base de rueda de 166"	
F	68	1300B Todos Exc. Travelette c/ base de rueda de 166"	
F	68	1300C Todos Exc. Travelette c/ base de rueda de 166"	

### Lista numérica

Amort.	POP	No. Alternativo	Montaje Accesorio
Pos.	Año	Aplicación	
82007	W	-continued	140349
F	68-72	M1100 / M1200 Todos	
F	69	M1400 Todos	
F	65-67	M SERIES VAN Todos	
F	61-66	JEEP CJ3 Todos Exc. 5 Resortes Helicoidales Delanteros y Kit de Levantamiento	
F	72-81	CJ5 Todos Exc. Kit de Levantamiento	
F	61-71	CJ5 Todos Exc. 5 Resortes Helicoidales Delanteros y Kit de Levantamiento	
F	73-81	CJ5D	
F	72-75	CJ6 Todos Exc. Kit de Levantamiento	
F	66-71	CJ6 Todos Exc. 5 Resortes Helicoidales Delanteros y Kit de Levantamiento	
F	76-81	CJ7 Todos Exc. Kit de Levantamiento	
F	66-74	DJ5 Todos Exc. Kit de Levantamiento	
F	66-68	DJ6 Todos	
F	57-65	FC150 Todos	
F	67-73	JEEPSTER Todos	
R	67-69	JEEPSTER Todos	
F	81	SCRAMBLER / CJ8 Todos	
F	61-67	UNIVERSAL Todos	
82012	W		
F	69-74	FORD VAN 1/2 TON, ECONOLINE / CLUB WAGON Todos	
F	68	VAN 1/2 TON, ECONOLINE / CLUB WAGON Todos A finales de 1968	
F	69-74	VAN 1 TON, ECONOLINE / CLUB WAGON / SUPERDUTY Todos	
F	68	VAN 1 TON, ECONOLINE / CLUB WAGON / SUPERDUTY Todos A finales de 1968	
F	69-74	VAN 3/4 TON, ECONOLINE / CLUB WAGON / SUPERDUTY Todos	
F	68	VAN 3/4 TON, ECONOLINE / CLUB WAGON / SUPERDUTY Todos A finales de 1968	
82030	W		
R	74	INTERNATIONAL 100 Todos	
R	75	150 4x2 Tracción trasera	
F	74-75	200 Todos	
R	74-75	200 Todos	
R	69-70	1000D Todos Antes de Chasis #H-205000	
R	71-72	1010 Todos Antes de Chasis #H-205000	
F	69-70	1100D Todos	
R	69-70	1100D Todos	
F	71-73	1110 Todos	
R	71-73	1110 Todos	
F	69-70	1200D Todos	
R	69-70	1200D Todos	
F	71-73	1210 Todos	
R	71-73	1210 Todos	
F	69-70	1300D Todos	
R	69-70	1300D Todos	
F	71-73	1310 Todos	
R	71-73	1310 Todos	
F	75	TRAVELALL Todos	
82031	W		
F	70-79	VOLKSWAGEN TRANSPORTER Todos	
82032	W		
R	68-79	VOLKSWAGEN TRANSPORTER Todos	
82033	W		140169
F	77-78	FORD F-100	
F	66-74	F-100	
F	70-76	PICKUP 1/2 TON, F-100 4x4 Exc. Kit de Levantamiento	
F	66-69	PICKUP 1/2 TON, F-100 Todos 4x4; Exc. Kit de Levantamiento	
F	65	PICKUP 1/2 TON, F-100 Todos 4x4; late 1965; Exc. Kit de Levantamiento	
F	76	PICKUP 1/2 TON, F-150 4x4 Exc. Kit de Levantamiento	
F	75	PICKUP 1/2 TON, F-150 Todos 4x4; Exc. Kit de Levantamiento	
82034	W		141138
F	65	FORD PICKUP 1/2 TON, F-100 Todos Principios de 1965	

## Lista numérica

Amort.	POP	No. Alternativo	Montaje Accesorio
Pos.	Año	Aplicación	
<b>82034</b>	W	-continued	141138
F	73-77	PICKUP 3/4 TON, F-250 / SUPERDUTY 4x4 Toda la serie No. Y20000	
F	61-72	PICKUP 3/4 TON, F-250 / SUPERDUTY Todos 4x4; Toda la serie No. Y20000	
<b>82035</b>	W		140357
F	61-62	CHEVROLET PICKUP 1/2 TON, C10 Todos	
F	61-62	PICKUP 1 TON, C30 Todos	
F	61-62	PICKUP 3/4 TON, C20 Todos	
F	61-62	SUBURBAN 1/2 TON, 1500 Todos	
F	62	VAN 1/2 TON, P SERIES Todos	
F	61-62	GMC PICKUP 1500 SERIES Todos	
F	61-62	PICKUP 2500 SERIES Todos	
<b>82038</b>	W		141138
F	61-64	FORD PICKUP 1/2 TON, F-100 4x2 Tracción trasera	
F	61-62	PICKUP 3/4 TON, F-250 / SUPERDUTY 4x2 Tracción trasera	
<b>82046</b>	W		
F	61-71	DODGE PICKUP 1/2 TON, D100 SERIES Todos	
F	61-71	PICKUP 1 TON, D300 SERIES Todos	
F	61-71	PICKUP 3/4 TON, D200 SERIES Todos	
<b>82047</b>	W		140630
F	61-67	CHEVROLET VAN 3/4 TON, P SERIES Todos	
F	67	GMC VAN 1 TON, P SERIES Todos	
F	67	VAN 3/4 TON, P SERIES Todos	
<b>82049</b>	W		140121
F	68	INTERNATIONAL 1000B Todos	
F	68	1000C Todos	
F	69-70	1000D Todos Antes de Chasis #H-205000	
F	71-73	1010 Todos	
<b>82051</b>	W		
R	59-64	CHEVROLET IMPALA Todos	
<b>82054</b>	W		
R	60-71	DODGE PICKUP 1/2 TON, D100 SERIES Todos	
R	60-71	PICKUP 1/2 TON, W100 SERIES Todos	
R	60-71	PICKUP 3/4 TON, D200 SERIES Todos	
R	69-71	PICKUP 3/4 TON, W200 SERIES Todos	
R	60-67	PICKUP 3/4 TON, W200 SERIES Todos	
<b>82062</b>	W		
F	70	CHEVROLET VAN 1/2 TON, G / EXPRESS Todos Eje Delantero Rígido	
F	64-69	VAN 1/2 TON, G / EXPRESS Todos Eje Delantero Rígido	
F	70	VAN 3/4 TON, G / EXPRESS Todos Eje Delantero Rígido	
F	67-69	VAN 3/4 TON, G / EXPRESS Todos Eje Delantero con Viga en I	
F	70	GMC VAN 1/2 TON, G / SAVANNA Todos Eje Delantero con Viga en I	
F	64-69	VAN 1/2 TON, G / SAVANNA Todos Eje Delantero con Viga en I	
F	70	VAN 3/4 TON, G / SAVANNA Todos Eje Delantero con Viga en I	
F	67-69	VAN 3/4 TON, G / SAVANNA Todos Eje Delantero con Viga en I	
<b>82065</b>	W		140478
R	74	DODGE M300 Todos H3, M3, M-375 H4, M4	
R	74	M350 Todos H3, M3, M-375 H4, M4	
F	60	PICKUP 1/2 TON, W100 SERIES Todos	
R	61-71	PICKUP 1 TON, D300 SERIES Todos	
F	60	PICKUP 3/4 TON, W200 SERIES Todos	
<b>82072</b>	W		140126
F	57-61	PLYMOUTH SUBURBAN Todos	
<b>82086</b>	W		
R	61-62	CHEVROLET PICKUP 1/2 TON, C10 Todos	
R	61-62	PICKUP 3/4 TON, C20 Todos	
R	60-62	SUBURBAN 1/2 TON, 1500 Todos	
R	62	VAN 1/2 TON, P SERIES Todos	
R	61-62	GMC PICKUP 1500 SERIES Todos	

## Amortiguadores Guardian, Bases de Struts

Amort.	POP	No. Alternativo	Montaje Accesorio
Pos.	Año	Aplicación	
<b>82090</b>	D		140126
F	70-74	DODGE CHALLENGER Todos	
F	66-72	CHARGER Todos	
<b>82118</b>	D		141983
F	59-64	CHEVROLET IMPALA Todos	
<b>82123</b>	W		141045
R	57-59	FORD F SERIES Todos F-100, F-250	
R	60	PICKUP 1/2 TON, F-100 Todos	
R	60	PICKUP 3/4 TON, F-250 / SUPERDUTY Todos	
R	68-75	PICKUP P350 Todos	
R	75-76	PICKUP P400 Todos	
<b>82125</b>	W		140523
R	75-76	CADILLAC COMMERCIAL CHASSIS Todos	
R	72-76	MAZDA B1600 Todos	
R	77-78	B1800 Todos	
R	79-84	B2000 Todos	
R	82-84	B2200 Todos	
<b>82131</b>	W		
R	70-74	DODGE CHALLENGER Todos	
R	66-76	CHARGER Todos	
<b>82147</b>	W		
R	65-69	FORD PICKUP 1/2 TON, F-100 Todos 4x2 Tracción trasera	
R	73-77	PICKUP 3/4 TON, F-250 / SUPERDUTY 4x4 Toda la serie No. Y20000	
R	66-72	PICKUP 3/4 TON, F-250 / SUPERDUTY Todos Toda la serie No. Y20000	
<b>82155</b>	W		141041
R	61-62	CHEVROLET VAN 3/4 TON, P SERIES Todos	
<b>82601</b>	W		140455
F	75-76	CADILLAC COMMERCIAL CHASSIS Todos	
<b>Bases de Struts</b>			
<b>141578</b>	W		
F	83-87	DODGE CHARGER Todos	
<b>142132</b>	W		
R	92-93	CADILLAC COMMERCIAL CHASSIS 4x2 Tracción delantera Suspensión Trasera Asistida por Aire; Exc. Suspensión Electrónica Ajustable	
R	91	COMMERCIAL CHASSIS Todos Suspensión Trasera Asistida por Aire; Exc. Suspensión Electrónica Ajustable	
R	85-90	COMMERCIAL CHASSIS Todos Equipamiento Estándar para Suspensión Trasera Asistida por Aire	
<b>142173</b>	W		
R	83-87	DODGE CHARGER Todos	
<b>142225</b>	W		
F	85-90	CADILLAC COMMERCIAL CHASSIS Todos	
<b>142226</b>	W		
F	92-93	CADILLAC COMMERCIAL CHASSIS 4x2 Tracción delantera	
F	91	COMMERCIAL CHASSIS Todos	
<b>142227</b>	W		
F	92-93	CADILLAC COMMERCIAL CHASSIS 4x2 Tracción delantera	
F	85-91	COMMERCIAL CHASSIS Todos	
<b>142230</b>	C		
R	06-12	HONDA RIDGELINE Todos	
<b>142316</b>	W		
F	88-94	CHEVROLET BLAZER, S MODELS 4x4, Barra de Torsion (FrontSpringType)	
F	88-04	S10 4x4, Barra de Torsion (FrontSpringType)	
F	05	GMC JIMMY 4x4	
F	92-04	JIMMY Todos	
F	83-91	S15 JIMMY Todos	
F	88-94	SONOMA / S15 4x4, Barra de Torsion (FrontSpringType)	

## Lista numérica

Amort.	POP	No. Alternativo	Montaje Accesorio
Pos.	Año	Aplicación	
<b>142316</b>	W	-continued	
F	91	SYCLONE Barra de Torsion (FrontSpringType)	
F	92-93	TYPHOON Todos	
<b>142326</b>	W		
F	95	MERCEDES-BENZ E300 Todos	
F	94	E500 Todos	
<b>142524</b>	W		
F	00-11	CHEVROLET IMPALA Todos	
<b>142525</b>	W		
F	00-10	CHEVROLET IMPALA Todos	
<b>142526</b>	D		
F	00-11	CHEVROLET IMPALA Todos	
F	05-09	UPLANDER 4x2 Tracción delantera	
<b>142751</b>	W		
F	92-93	CADILLAC COMMERCIAL CHASSIS 4x2 Tracción delantera COMMERCIAL CHASSIS Todos	
F	91	COMMERCIAL CHASSIS Todos	
<b>142752</b>	W		
F	85-90	CADILLAC COMMERCIAL CHASSIS Todos	
<b>142838</b>	W		
F	90-02	TOYOTA 4RUNNER Todos Exc. HD	
<b>143073</b>	A		
R	00-11	CHEVROLET IMPALA Todos Izquierdo	
<b>143074</b>	W		
R	00-11	CHEVROLET IMPALA Todos Derecho	
<b>143241</b>	D		
F	02-09	CHEVROLET TRAILBLAZER Todos	
F	02-09	GMC ENVOY Todos	
<b>143244</b>	W		
F	03-06	FORD EXPEDITION Todos Exc. Suspensión de Aire	
F	03-05	LINCOLN NAVIGATOR Todos	
<b>143248</b>	C		
F	04-08	FORD PICKUP 1/2 TON, F-150 Todos	
F	06-08	LINCOLN MARK LT Todos	
<b>143253</b>	C		
F	01-11	FORD ESCAPE Todos	
<b>143255</b>	D		
F	02-11	JEEP LIBERTY Todos Izquierdo	
<b>143266</b>	D		
F	02-11	JEEP LIBERTY Todos Derecho	
<b>143316</b>	D		
F	07-13	CADILLAC ESCALADE Todos Exc. Control de Manejo Electrónico	
F	07-13	ESCALADE ESV Todos Exc. Control de Manejo Electrónico	
F	07-13	ESCALADE EXT Todos Exc. Control de Manejo Electrónico	
F	07-13	CHEVROLET AVALANCHE 1500 Todos Exc. Control de Manejo Electrónico	
F	07-13	PICKUP 1/2 TON, SILVERADO 1500 Todos Exc. Suspensión Electrónica Ajustable	
F	07-13	SUBURBAN 1/2 TON, 1500 Todos Exc. Suspensión Z55 o ZW7	
F	07-13	TAHOE Todos Exc. Suspensión Z55 o ZW7	
F	12-13	GMC SIERRA 1500 Todos Exc. Susp. Elec. Ajustable	
F	07-11	SIERRA 1500 Todos Exc. Suspensión Electrónica Ajustable	
F	07-13	YUKON Todos Exc. Suspensión Electrónica Ajustable	
F	07-13	YUKON XL 1/2 TON Todos Exc. Suspensión Z55 Auto Ride	
<b>143317</b>	W		
R	03-06	FORD EXPEDITION Todos	
<b>143318</b>	W		
F	02-05	FORD EXPLORER Todos	
<b>143319</b>	W		
R	02-05	FORD EXPLORER Todos	

## Lista numérica

Amort.	POP	No. Alternativo	Montaje Accesorio
Pos.	Año	Aplicación	
143324	W		
F	06-08	<b>DODGE</b> PICKUP 1/2 TON, RAM 1500 4x4 Exc. Mega Cab	
143325	W		
F	96-02	<b>TOYOTA</b> 4RUNNER 4x4	
F	95-04	TACOMA 4x4	
F	00-06	TUNDRA Todos	
143330	W		
F	06-10	<b>FORD</b> EXPLORER Todos	
143335	W		
R	08-10	<b>DODGE</b> CHALLENGER Todos	
R	06-10	CHARGER Todos	
143337	W		
R	07-12	<b>DODGE</b> CALIBER Todos	
143339	W		
F	07-12	<b>TOYOTA</b> TUNDRA Todos	
143340	W		
R	07-11	<b>TOYOTA</b> TUNDRA Todos	
143356	W		
F	03-11	<b>FORD</b> CROWN VICTORIA Todos	
143357	W		
F	07-11	<b>FORD</b> CROWN VICTORIA Todos	
F	03-06	CROWN VICTORIA Base	
F	03-06	CROWN VICTORIA LX	
F	04-05	CROWN VICTORIA LX Sport	
F	05	CROWN VICTORIA S	
F	05	CROWN VICTORIA Special Edition	
F	03	CROWN VICTORIA LWB	
F	03	CROWN VICTORIA S	
143358	W		
F	04-11	<b>NISSAN</b> TITAN Todos	
143359	N		
F	04-11	<b>NISSAN</b> TITAN Todos	
143360	W		
F	06-10	<b>FORD</b> EXPLORER Todos	
143361	W		
R	06-10	<b>FORD</b> EXPLORER Todos	
143362	N		
R	06-10	<b>FORD</b> EXPLORER Todos	
143364	W		
F	06-10	<b>JEEP</b> COMMANDER Todos	
F	05-10	GRAND CHEROKEE Todos	
143369	W		
F	08-10	<b>DODGE</b> CHALLENGER Todos	
F	06-10	CHARGER 4x2 Tracción trasera	
143376	FF		
F	07-09	<b>FORD</b> EXPEDITION 4x2 Tracción trasera	
F	09	PICKUP 1/2 TON, F-150 4x2 Tracción trasera	
F	07-09	<b>LINCOLN</b> NAVIGATOR Todos	
143379	N		
F	05-12	<b>NISSAN</b> FRONTIER Todos	
143383	N		
F	03-12	<b>TOYOTA</b> 4RUNNER Todos	
F	07-12	FJ CRUISER Todos	
F	05-12	TACOMA Todos	
143385	N		
F	06-09	<b>NISSAN</b> RAIDER Todos	
143389	N		
F	09-10	<b>DODGE</b> PICKUP 1/2 TON, RAM 1500 4x4	
F	07-12	<b>FORD</b> EXPEDITION 4x2 Tracción trasera	
F	11-12	<b>RAM</b> 1500 (SEE DODGE RAM 1500) 4x4	
143393	FF		
R	07-12	<b>FORD</b> EXPEDITION 4x2 Tracción trasera	
R	07-12	<b>LINCOLN</b> NAVIGATOR 4x2 Tracción trasera	
143424	N		
F	10-12	<b>FORD</b> EXPEDITION 4x2 Tracción trasera	
F	10-12	PICKUP 1/2 TON, F-150 Todos	
F	09-12	<b>LINCOLN</b> NAVIGATOR Todos	

## Bases de Struts, Protectores de Struts

Amort.	POP	No. Alternativo	Montaje Accesorio
Pos.	Año	Aplicación	
<b>Protectores de Struts</b>			
143057	W		
F	83-87	<b>DODGE</b> CHARGER Todos	
143059	W		
F	78-83	<b>DODGE</b> CHALLENGER Todos	
143060	D		
F	92-93	<b>CADILLAC</b> COMMERCIAL CHASSIS 4x2 Tracción delantera	
R	92-93	COMMERCIAL CHASSIS 4x2 Tracción delantera	
R	85-91	COMMERCIAL CHASSIS Todos	
F	91	COMMERCIAL CHASSIS Todos	
F	00-11	<b>CHEVROLET</b> IMPALA Todos	
143061	C		
F	85-90	<b>CADILLAC</b> COMMERCIAL CHASSIS Todos	
R	00-11	<b>CHEVROLET</b> IMPALA Todos	

## Lista numérica

Amort.	POP	No. Alternativo	Montaje Accesorio
Pos.	Año	Aplicación	



# Amortiguadores Para Camiones Medios y Pesados, Remolques Y Autobuses

(Lista alfabética)  
(Lista numérica)

**GRC**<sup>®</sup>  
AUTOPARTES

Maneja el espíritu independiente™

## GUÍA DE APLICACIONES – CAMIONES, TRÁILERS Y AUTOBUSES

Año	Modelo	# E.O.	Delantero				Trasero			
			Fleetline	GasSLX	Fleetline	GasSLX				

### ABC BUS

	Autobuses Van Hool T2100 con Número de E.O. (Amortiguadores de Eje Delantero y Tarjeta)	10685703	- -	<b>695406</b>	...	...	...	...
		624314570	- -	<b>695406</b>	...	...	...	...
		90-2291	- -	<b>695406</b>	...	...	...	...
	Eje Motriz	12J-5-10	...	...	0 -	<b>85733</b>	...	...
	Modelos con Número de E.O.	050134513	0 0	<b>85732</b>	...	...	...	...
		12L-5-88	...	...	0 -	<b>85729</b>	...	...
		6243-13790	- -	<b>85708</b>	...	...	...	...
		6243-14040	- -	<b>85708</b>	...	...	...	...
	Intercambios Adicionales de E.O.	12B-5-1	0 0	<b>85735</b>				
		12L-5-114	- -	<b>85727</b>				
		3166657	0 0	<b>85700</b>				
		680323	0 0	<b>85700</b>				

### ACF BRILL BUS

	Autobús C-27 y C-31	....	0 0	<b>85307</b>				
	Autobús C-36 Número de Serie 1051 en adelante	....	0 0	<b>85307</b>				
	Autobús C-44 y Trolebús T-44	....	0 0	<b>85308 or 89422</b>				
	IC-41 Autobús Foráneo hasta No. Serie 1088	....	0 0	<b>85307</b>				
	IC-41 Autobús Foráneo No. Serie 1088 en adelante	....	0 0	<b>85308 or 89422</b>				
	Modelos 37R	....	0 0	<b>83225</b>	...	...	...	...
	Modelos C-37M	....	0 0	<b>83225</b>				
	Intercambios Adicionales de E.O.	610513	0 0	<b>85307</b>				
		631237	0 0	<b>85308 or 89422</b>				
		641521	0 0	<b>85308 or 89422</b>				
		649648	0 0	<b>85308 or 89422</b>				
		659129	0 0	<b>85303 or 89422</b>				
		661732	0 0	<b>83215</b>				
		661733	0 0	<b>83225</b>				
		995891	0 0	<b>85307</b>				

### ADVANCE MIXER

	Número de Parte de Mezcladora Advance	13424 ADV	0 0	...	...	0 0	<b>83207</b>	<b>89407</b>
		13883 ADV		<b>85334</b>	...	...	...	...
		14626 ADV		...	...	0 0	<b>83209</b>	...
		23458 ADV		...	...	0 -	<b>83112</b>	...
	Modelos con Número de E.O.	680087	0 0	<b>85334</b>	...	...	...	...

### ALLCO TRAILER

	Camiones de Volteo con Suspensión de Aire Watson & Chalin TA-5000-DB-19	727602	...	...	0 0	<b>83122</b>	<b>89406</b>
--	---	--------	-----	-----	-----	--------------	--------------





### AM GENERAL

	Autobús Pequeño	5979484	...	...	0 0	<b>85302</b>	<b>89420</b>	
	Intercambios Adicionales de E.O.	3166657	0 0	<b>85700</b>				
		4975501	0 0	<b>85700</b>				
		5565748	0 0	<b>85700</b>				
		5957136	0 0	<b>85700</b>				
		5969438	0 0	<b>85700</b>				
		5978712	0 0	<b>85700</b>				
		5979574	0 0	<b>85700</b>				
		5982537	0 0	<b>85700</b>				

### ARVIN MERITOR

	Modelos con Número de Manufactura	085009	- 0	<b>85009</b>				
		085014	...	...	0 0	<b>85014</b>	...	

**GUÍA DE APLICACIONES – CAMIONES, TRÁILERS Y AUTOBUSES**

Año	Modelo	# E.O.	Delantero		Trasero	
						
			Fleetline	GasSLX	Fleetline	GasSLX

**ARVIN MERITOR (Cont.)**

Modelos con Número de Manufactura	085321	...	...	010	<b>85321</b>	...	
	654907	...	...	010	<b>85000</b>	<b>89436</b>	
	665724	...	...	010	<b>85000</b>	<b>89436</b>	
	665769	...	...	010	<b>85052</b>	...	
	665804	...	...	010	<b>85939</b>	...	
	671092	010	<b>85012</b>	<b>89413</b>		...	...
	671707	...	...	010	<b>85052</b>	...	
	680102	010	<b>85712</b>				
	680322	010	<b>85704</b>				
	680518	010	<b>85700</b>				
	680584	...	...	010	<b>85938</b>	...	
	680671	...	...	- -	<b>85708</b>	...	
	695159	- -	<b>85982</b>				
	695172	- -	<b>85707</b>				
	695214	- -	<b>85722</b>				
	695406	- -	<b>695406</b>				
	Motor Home Blue Bird con IFS (37 Pies)	7805-N-1002	010	<b>85329</b>	...		...
7805-S-1007		010	<b>85329</b>	...		...	

**AUTOCAR**

DC87T, DC9364 dese Feb. 1971	....	010	<b>83122</b>	<b>89406</b>		...	...
Modelos A42B, A42F, A64B A64F Desde Feb. 1971 Hasta Ene. 1971	03-1106460	010	<b>85005</b>	<b>89430</b>		...	...
	28R010	010	<b>83216</b>	...		...	...
Modelos ACM, ACL	35901-3201	...	...	010	<b>85024</b>	<b>89416</b>	
	37301-3201	- -	<b>85027</b>	<b>89418</b>		...	...
Modelos C65T, C70T, C70TS, C90, C75, C90T, DC74, DC75, DC102, DC104	....	010	<b>83216</b>	...		...	...
Modelos con Suspensión de Aire y Número de E.O.	8026658	...	...	010	<b>85046</b>	<b>89434</b>	
	8071524	...	...	010	<b>85024</b>	<b>89416</b>	
Modelos con Número de E.O.	1011839	010	<b>83216</b>	...		...	...
	28CFG-910	010	<b>83216</b>	...		...	...
	37301-3202	01-	<b>85026</b>	<b>89417</b>		...	...
	660186	010	<b>83216</b>	...		...	...
	849246	010	<b>83216</b>	...		...	...

**BECK BUS**

Autobús Luxury Liner - Suspensión de Muelles	....	010	<b>85307</b>				
Deck y Autobús 1/2 - Rueda de Secuencia	....		...	...	010	<b>85301</b>	...
Deck y Autobús 1/2 - Suspensión de Aire	....	010	<b>85307</b>				
Deck y Autobús 1/2 con Suspensión de Aire	....	010	<b>85304</b>				
Mainliner con Suspensión de Aire	....	010	<b>85304</b>				
Modelos con Número de E.O.	14QK-140	010	<b>85304</b>	...		...	...
	14QK-2102		...	...	010	<b>85304</b>	...





**BENSON TRUCK BODIES INC.**

Modelos con Suspensión de Aire Hendrickson Intrax	A-20002		...	...	010	<b>85000</b>	<b>89436</b>
Modelos con Suspensión de Aire Neway	90044089		...	...	010	<b>83124</b>	<b>89407</b>

**BERING TRUCK CORP.**

Modelos con Suspensión Hendrickson HAS-230	47902-24		...	...	010	<b>83121</b>	...
Modelos HD80TT con Suspensión de Aire Hendrickson HAS-400	47902-24		...	...	010	<b>83121</b>	...

**GUÍA DE APLICACIONES – CAMIONES, TRÁILERS Y AUTOBUSES**

Año	Modelo	# E.O.	Delantero		Trasero	
						
			Fleetline	GasSLX	Fleetline	GasSLX

**BLUEBIRD SCHOOL BUS**

**Autobús Escolar Tipo A**

92 - 15	Autobús Escolar Microbird Tipo A con Chasis Ford E350	8C24-18045-DA	-10	83177	...		...	...
		8C24-18080-DB		...	...	-10	83178	...
		8C2Z-18124-D	-10	83177	...		...	...
		8C2Z-18125-D		...	...	-10	83178	...
		ASH-1136		...	...	-10	83178	...
		ASH-1154	-10	83177	...		...	...
		AT-163G	-10	83177	...		...	...
		AT-164G		...	...	-10	83178	...
00 - 15	Autobús Escolar Microbird Tipo A con Chasis Ford E450	8C24-18045-DA	-10	83177	...		...	...
		8C24-18080-DB		...	...	-10	83178	...
		8C2Z-18124-D	-10	83177	...		...	...
		8C2Z-18125-D		...	...	-10	83178	...
		ASH-1136		...	...	-10	83178	...
		ASH-1154	-10	83177	...		...	...
		AT-163G	-10	83177	...		...	...
		AT-164G		...	...	-10	83178	...



**Series All American (Modelos FE & RE)**

	Autobuses con Eje Steertek Hendrickson Tipo Left Hand Drive con Capacidad de 14,600 lb	58913-011	010	85959	...		...	...
	Autobuses con Muelles de 2 Etapas de 19,000 lb - 21,000 lb	AMS65110		...	...	010	85005	89430
	Autobuses con Muelles Parabólicas de 2 Hojas de 13,200 lb	1658525	010	85971	...		...	...
		AMS65109	010	85058	89431		...	...
	Autobuses con Número de E.O.	0823054	010	85304	...		...	...
	Autobuses con Suspensión de Aire Delantera Airtek Hendrickson	0110808	010	83124	89407		...	...
	Autobuses con Suspensión Parasteer Hendrickson	0015222	010	85919	...		...	...
		0040015	010	85919	...		...	...
		481700131438	010	85919	...		...	...
		59483-000	010	85919	...		...	...
		60665-005	010	85919	...		...	...
	Autobuses con Suspensión Softek Hendrickson (Capacidad de 13,200 lb - 14,600 lb)	60998-002	010	85919	...		...	...
		0106303	010	85106	...		...	...
		471700002919	010	85106	...		...	...
		58913-010	010	85106	...		...	...
05 - 13	Autobuses con Suspensión Trasera de Muelles	0088035		...	...	010	85090	...
	Autobuses con Suspensiones de Aire Comfort	00085991		...	...	010	85006	...
		471700000428		...	...	010	85006	...
		60998-003		...	...	010	85006	...
06 - 10	Autobuses con Suspensiones de Aire Comfort	60998-001		...	...	010	85006	...
	Sólo Modelos RE (Motor Atrás) con Suspensión de Aire Ejes de Dirección Ridewell RAS - 227	1260008		...	...	010	87017	...
		90-2610 SP1		...	...	010	87017	...

**Series D3 (Modelos FE & RE)**

	Autobuses con Suspensión de Aire Delantera Airtek Hendrickson	0110808	010	83124	89407		...	...
	Autobuses con Suspensión de Aire Delantera Airtek Hendrickson (Capacidad de 14,600 lb)	58913-011	010	85959	...		...	...
	Autobuses con Suspensión Softek Hendrickson (Capacidad de 13,200 lb - 14,600 lb)	0106303	010	85106	...		...	...
		471700002919	010	85106	...		...	...
		58913-010	010	85106	...		...	...
	Autobuses con Suspensión Trasera de Muelles	0088035		...	...	010	85090	...
	Autobuses con Suspensiones de Aire Comfort	00085991		...	...	010	85006	...
		471700000428		...	...	010	85006	...
		60998-001		...	...	010	85006	...

**GUÍA DE APLICACIONES – CAMIONES, TRÁILERS Y AUTOBUSES**

Año	Modelo	# E.O.	Delantero		Trasero	
						
			Fleetline	GasSLX	Fleetline	GasSLX

**BLUEBIRD SCHOOL BUS (Cont.)**

**Series Vision (Cont.)**

	Autobuses con Suspensión de Aire Delantera Airtek Hendrickson	00119797	010	<b>85959</b>	...		...	...
		65992-003	010	<b>85959</b>	...		...	...
- 13	Autobuses con Suspensión de Aire Delantera Airtek Hendrickson	0085990	010	<b>85959</b>	...		...	...
06	Autobuses con Suspensión de Aire Delantera Airtek Hendrickson	0055017	010	<b>85959</b>	...		...	...
06 - 10	Autobuses con Suspensión de Aire Delantera Airtek Hendrickson	58913-007	010	<b>85959</b>	...		...	...
06 - 10	Autobuses con Suspensión de Aire Delantera Airtek Hendrickson (Capacidad de 10,000 lb)	471700000456	010	<b>85959</b>	...		...	...
		58913-008	010	<b>85959</b>	...		...	...
		58913-009	010	<b>85959</b>	...		...	...
	Autobuses con Suspensión de Aire Delantera Airtek Hendrickson (Capacidad de 14,600 lb)	58913-011	010	<b>85959</b>	...		...	...
- 13	Autobuses con Suspensión Delantera Softek Hendrickson	0085990	010	<b>85959</b>	...		...	...
	Autobuses con Suspensión Softek Hendrickson (Capacidad de 13,200 lb - 14,600 lb)	0106303	010	<b>85106</b>	...		...	...
		471700002919	010	<b>85106</b>	...		...	...
		58913-010	010	<b>85106</b>	...		...	...
06 - 10	Autobuses con Suspensión Softek Hendrickson (Capacidad de 8,000 lb - 10,000 lb)	471700000456	010	<b>85959</b>	...		...	...
		58913-007	010	<b>85959</b>	...		...	...
		58913-007L	010	<b>85959</b>	...		...	...
		58913-009	010	<b>85959</b>	...		...	...
06	Autobuses con Suspensión Softek Hendrickson con Eje Steertek	0055008	010	<b>85959</b>	...		...	...
05 - 10	Autobuses con Suspensión Trasera de Muelles	471700000464		...	...	010	<b>85090</b>	...
05 - 13	Autobuses con Suspensión Trasera de Muelles	0088035		...	...	010	<b>85090</b>	...
	Autobuses con Suspensiones de Aire Comfort	471700000428		...	...	010	<b>85006</b>	...
		60998-003		...	...	010	<b>85006</b>	...
- 13	Autobuses con Suspensiones de Aire Comfort	00085991		...	...	010	<b>85006</b>	...
06 - 10	Autobuses con Suspensiones de Aire Comfort	471700131545		...	...	010	<b>85006</b>	...
		60998-001		...	...	010	<b>85006</b>	...

**TC 2000 Bus, TC/2000 Series FE**

	Autobuses con Muelles Delanteros Parabólicos Estándar	1658525	010	<b>85971</b>	...		...	...
	Autobuses con Muelles Planos Estándar Traseros	1746163		...	...	010	<b>85006</b>	...
	Autobuses con Suspensión Delantera de Aire Ridewell Opción #4540	1004167	010	<b>85712</b>	...		...	...
		1317767	010	<b>85029</b>	...		...	...
		1667831	010	<b>85029</b>	...		...	...
		300-1317767	010	<b>85029</b>	...		...	...
		AMS65119	010	<b>85029</b>	...		...	...
	Autobuses con Suspensión Trasera de Aire Neway	90045050		...	...	010	<b>85914</b>	...
	Autobuses con Suspensión Trasera Ridewell Opción #4540	1316546		...	...	010	<b>85006</b>	...
		1658533		...	...	010	<b>85010</b>	...
		305-0961284		...	...	010	<b>85734</b>	...

**Aplicaciones Adicionales**

	Autobús Escolar Modelos FE (Motor Adelante)	0014605		...	...	010	<b>85036</b>	<b>89405</b>
		0014985		...	...	010	<b>83137</b>	...
		59057-001		...	...	010	<b>83137</b>	...
		59057-002		...	...	010	<b>85036</b>	<b>89405</b>
	Autobús Escolar Modelos RE (Motor Atrás) con Pernos de Montaje de 1"	300-0614966	010	<b>85307</b>	...		...	...
		300-0614974		...	...	010	<b>85304</b>	...
		609180		...	...	010	<b>85304</b>	...
		614958	010	<b>85307</b>	...		...	...
	Autobuses City Bird con Pernos de Montaje de 1 "	300-0614966	010	<b>85307</b>	...		...	...



## GUÍA DE APLICACIONES – CAMIONES, TRÁILERS Y AUTOBUSES

Año	Modelo	# E.O.	Delantero		Trasero	
			Fleetline	GasSLX	Fleetline	GasSLX

### BLUEBIRD SCHOOL BUS (Cont.)



#### Aplicaciones Adicionales (Cont.)

	Autobuses City Bird con Pernos de Montaje de 1 "	300-0614974		...	...	010	<b>85304</b>	...
		609180		...	...	010	<b>85304</b>	...
		614958	010	<b>85307</b>	...			...
		614966	010	<b>85307</b>	...			...
	Autobuses con Chasis de 35"	303-1350628	010	<b>85712</b>	...			...
		90-1968	010	<b>85712</b>	...			...
	Autobuses con Pernos de Montaje de 3/4"	2021459	010	<b>85012 or 89413</b>				
	Autobuses con Suspensión de Aire Ridewell	1668722	010	<b>85030</b>	89440		...	...
		1668730		...	...	010	<b>85013</b>	89414
		1722222		...	...	010	<b>85013</b>	89414
	Autobuses con Suspensión Trasera de Muelles Planas de 8,200 lb a 10,400 lb	1707405		...	...	010	<b>85005</b>	...
	Autobuses con Suspensiones de Aire Neway con Número de E.O.	1526417		...	...	010	<b>85052</b>	...
		90044448		...	...	010	<b>85051</b>	...
		90044915		...	...	010	<b>83127</b>	...
		90045083		...	...	010	<b>85910</b>	...
	Modelos de Autobús Piso Bajo con Número de E.O.	0075916	010	<b>85086</b>	...		...	...
		4759272		...	...	- -	...	89447
		4760958	010	<b>85086</b>	...		...	...
		680667		...	...	- -	...	89447
	Modelos WanderLodge LX, LXI Delantero Trasera	90-2497-SP1		....	...		...	...
		90-1951-SP1		...	...	010	<b>85734</b>	...
	Motorhome con IFS (37 Pies)	7805-N-1002	010	<b>85329</b>	...		...	...
		7805-S-1007	010	<b>85329</b>	...		...	...
	WanderLodge Eje Motriz con Suspensión de Aire Reyco Delantero	1750793		...	...	010	<b>85712</b>	...
		1722214		...	...	010	<b>85030</b>	89440
		90-1968-SP1	010	<b>85712</b>	...		...	...
	Modelos con Número de E.O.	0020326		...	...	010	<b>85976</b>	...
		300-1316546		...	...	010	<b>85006</b>	...
		614974	010	<b>85304</b>	...		...	...
		65992-004	010	<b>85106</b>	...		...	...
		680783	010	<b>85304</b>	...		...	...

#### Intercambios Adicionales de E.O.

	Intercambios Adicionales de E.O.	0523047	010				<b>85736</b>	
		1217934	010				<b>85304</b>	
		1962422	010				<b>85304</b>	
		1962430	010				<b>83207 or 89407</b>	
		23106-01	010				<b>85975</b>	
		300-0823047	010				<b>85736</b>	
		300-0823054	010				<b>85304</b>	
		300-09612284	010				<b>85734</b>	
		671933	010				<b>85919</b>	
		680102	010				<b>85712</b>	
		680155	010				<b>85712</b>	
		70317	010				<b>89402</b>	
		70397	010				<b>85006</b>	
		7805-M-1001	010				<b>85919</b>	
		87001-01A	010				<b>85734</b>	
		90-1813	010				<b>85712</b>	
A-4890	010				<b>85712</b>			

**GUÍA DE APLICACIONES – CAMIONES, TRÁILERS Y AUTOBUSES**

Año	Modelo	# E.O.	Delantero		Trasero	
						
			Fleetline	GasSLX	Fleetline	GasSLX

**BREDA BUS**

Modelos con Número de E.O.	500-403-4		...	...		....	...
----------------------------	-----------	--	-----	-----	--	------	-----

**BROCKWAY SCHOOL BUS**

Autobús de Pasajeros Tipo Escolar 55 y 61 con Pernos de Montaje de 1" con Pernos de Montaje de 3/4"	.....	010	<b>83216</b>	...	010	<b>85305</b>	...
Autobús Escolar con Capacidad menor a 55 Pasajeros	.....	010	<b>83216</b>	...		...	...
Modelos 257T, 260S, 260T	.....	010	<b>83207</b>	<b>89407</b>		...	...
Modelos 300, 400, 500 con Pernos de Montaje de 1" con Pernos de Montaje de 3/4"	.....	010	<b>85307</b>	...		...	...
Modelos 88WH, 128W, 154W	.....	010	<b>85012</b>	<b>89413</b>		...	...
Modelos con Número de E.O.	14QK-281P10	010	<b>83216</b>	...		...	...
	14QK-282P1	010	<b>83216</b>	...		...	...
	14QK-282P3	010	<b>83216</b>	...		...	...
	152398	010	<b>85304</b>	...		...	...
	152412	010	<b>83215</b>	...		...	...
	508657	010	<b>85307</b>	...		...	...
	515231	010	<b>85303</b>	<b>89422</b>		...	...
	530873	010	<b>83207</b>	<b>89407</b>		...	...
	532397	010	<b>85307</b>	...		...	...

**BUILT RITE**

Modelos con Suspensión de Aire	318-06-100		...	...	010	<b>85006</b>	...
--------------------------------	------------	--	-----	-----	-----	--------------	-----

**BUS & TRUCK CO.**

Silver Eagle	0100-905	010				<b>85307</b>	
	680091	010				<b>85303 or 89422</b>	
	70039	010				<b>85303 or 89422</b>	
	70041	010				<b>85305</b>	

**CARPENTER BUS**

Modelos con Número de E.O.	0272-SS5	010	<b>85712</b>	...		...	...
	63-0001		...	...	010	<b>85713</b>	...

**CASCADE TRAILER**

Modelos con Suspensión de Aire	120-1		...	...	010	<b>83125</b>	...
--------------------------------	-------	--	-----	-----	-----	--------------	-----

**CHALMERS SUSPENSION**

Kit para Modelos K800-199	665174		...	...	010	<b>85060</b>	...
Suspensión de Camión de Eje Sencillo (1023-23K, 1030 -30K, 1040-40K)	665174		...	...	010	<b>85060</b>	...
Modelos con Número de E.O.	21335		...	...	010	<b>G63355</b>	...
	800670		...	...	010	<b>85301</b>	...
	800781		...	...	010	<b>85314</b>	<b>89425</b>

**CHAMPION TRANSIT**

GMC Chasis P6000	22064230	- -	<b>83136</b>	...		...	...
	22064231		...	...	- -	<b>85324</b>	...

**CHANCE BUS**

Modelos con Número de E.O.	59039	010				<b>83207 or 89407</b>	
	665017		...	...	010	<b>85014</b>	...
	6892	010				<b>83207 or 89407</b>	
	6893	010	<b>83203</b>	<b>89436</b>		...	...
	728600	010				<b>83203 or 89436</b>	

## GUÍA DE APLICACIONES – CAMIONES, TRÁILERS Y AUTOBUSES

Año	Modelo	# E.O.	Delantero		Trasero	
			Fleetline	GasSLX	Fleetline	GasSLX

### CHANCE BUS (Cont.)

Modelos con Número de E.O.	AS789B	OIO	<b>85014</b>
Intercambios Adicionales de E.O.	270-6708	OIO	<b>85014</b>

### CHANCE COACH

#### Aplicaciones Adicionales

Autobuses con Pernos de Montaje de 3/4"	2021459	OIO	<b>85012 or 89413</b>
---	---------	-----	-----------------------

### CHEVROLET TRUCK (VER TAMBIÉN GMC)





#### Series 4, 40, 4000 & 4500

67 - 72	Autobús Escolar Modelo S-40	22012096	OIO	<b>83221</b>				
		3192892	OIO	<b>83221</b>				
68	Cowl - Exc. Autobús Escolar	22012096	OIO	<b>83221</b>	...		...	...
		3192892	OIO	<b>83221</b>	...		...	...
69 - 70	D-D Forward Control con Cabina Abatible	22012095	OIO	<b>83126</b>	<b>89430</b>		...	...
		4940606	OIO	<b>83126</b>	<b>89430</b>		...	...
69 - 70	D-D Forward Control con Ejes de 9000 & 11000 lb - Exc. Cabina Abatible	22012096	OIO	<b>83221</b>	...		...	...
		3192892	OIO	<b>83221</b>	...		...	...
60 - 62	Modelos C-40	.....		...	...	OIO	<b>83221</b>	...
63 - 68	Modelos C-40 , P-40, SS-40	.....	OIO	<b>85005</b>	<b>89430</b>	OIO	<b>83221</b>	...
67 - 68	TDM Detroit Diesel 4 Ciclos con Eje Tarjeta - Exc. Cabina Abatible	22012096		...	...	OIO	<b>83221</b>	...
		3192892		...	...	OIO	<b>83221</b>	...
69 - 72	Todos - Exc. Cabinas Abatibles	22012096	OIO	<b>83221</b>				
		3192892	OIO	<b>83221</b>				

#### Series 5, 50, 5000 & 5500

69 - 72	Autobús Escolar Modelo S-50	3192892	OIO	<b>83221</b>				
				...	...	OIO	<b>83126</b>	<b>89430</b>
73 - 78	Autobús Escolar Modelo S-50	22012166		...	...	OIO	<b>83221</b>	...
		3192892		...	...	OIO	<b>83221</b>	...
73 - 80	Chasis C, M, S - Cabina Convencional	22007750	OIO	<b>83207</b>	<b>89407</b>		...	...
		4975467	OIO	<b>83207</b>	<b>89407</b>		...	...
		4975494	OIO	<b>83207</b>	<b>89407</b>		...	...
75 - 80	Chasis C, M, S - Cabina Convencional	4975510	OIO	<b>83221</b>	...		...	...
76 - 89	Chasis C, M, S - Cabina Convencional	22002294	OIO	<b>83304</b>	...		...	...
		22007752	OIO	<b>83304</b>	...		...	...
		22012096		...	...	OIO	<b>83221</b>	...
		22012169		...	...	OIO	<b>83221</b>	...
73 - 80	Chasis C, S - Cabina Convencional y Autobús Escolar	22012096		...	...	OIO	<b>83221</b>	...
		3192892		...	...	OIO	<b>83221</b>	...
73 - 89	Chasis C, S - Cabina Convencional y Autobús Escolar	22012095		...	...	OIO	<b>83126</b>	<b>89430</b>
		22012166		...	...	OIO	<b>83126</b>	<b>89430</b>
68	Cowl - Exc. Autobús Escolar	22012096	OIO	<b>83221</b>	...		...	...
		3192892	OIO	<b>83221</b>	...		...	...
69 - 70	D-D Forward Control con Cabina Abatible	22012095	OIO	<b>83126</b>	<b>89430</b>		...	...
		4940606	OIO	<b>83126</b>	<b>89430</b>		...	...
69 - 70	D-D Forward Control con Ejes de 9000 & 11000 lb - Exc. Cabina Abatible	22012096	OIO	<b>83221</b>	...		...	...
		3192892	OIO	<b>83221</b>	...		...	...
63 - 68	Modelos C-50, M-50, S-50, SE-50, T-50	.....	OIO	<b>85005</b>	<b>89430</b>		...	...
63 - 69	Modelos C-50, M-50, S-50, SE-50, T-50	.....		...	...	OIO	<b>83221</b>	...
67 - 68	TDM Detroit Diesel 4 Ciclos con Eje Tarjeta - Exc. Cabina Abatible	22012096		...	...	OIO	<b>83221</b>	...
		3192892		...	...	OIO	<b>83221</b>	...
71 - 72	TDM Detroit Diesel 4 Ciclos con Eje Tarjeta - Exc. Cabina Abatible	22012095		...	...	OIO	<b>83126</b>	<b>89430</b>
		4940606		...	...	OIO	<b>83126</b>	<b>89430</b>
69 - 72	Todos - Exc. Cabinas Abatibles	22012096	OIO	<b>83221</b>				

**GUÍA DE APLICACIONES – CAMIONES, TRÁILERS Y AUTOBUSES**

Año	Modelo	# E.O.	Delantero		Trasero	
			 Fleetline	 GasSLX	 Fleetline	 GasSLX

**CHEVROLET TRUCK (VER TAMBIÉN GMC) (Cont.)**





**Series 5, 50, 5000 & 5500 (Cont.)**

69 - 72	Todos - Exc. Cabinas Abatibles	3192892	010	<b>83221</b>			
---------	--------------------------------	---------	-----	--------------	--	--	--

**Series 6, 60, 6000 & 6500**

76 - 89	Autobús Escolar - Chasis S	22002294	010	<b>83304</b>	...	...	...
		22007702	010	<b>83304</b>	...	...	...
		22007752	010	<b>83304</b>	...	...	...
79 - 89	Autobús Escolar B6P042 (Códigos de Eje F070, F070D)	22002294	010	<b>83304</b>	...	...	...
		22007752	010	<b>83304</b>	...	...	...
79 - 89	Autobús Escolar B6P042 (Códigos de Eje F090, F120D)	22002295	010	<b>83303</b>	...	...	...
		22007753	010	<b>83303</b>	...	...	...
		22017531	010	<b>83303</b>	...	...	...
79 - 89	Autobús Escolar B6P042 con Resortes Traseros de 15000 lb o 17000 lb	22012096		...	...	010	<b>83221</b>
		22012169		...	...	010	<b>83221</b>
79 - 89	Autobús Escolar B6P042 con Resortes Traseros de 18500 lb o 20800 lb	22012095		...	...	010	<b>83126</b> <b>89430</b>
		22012166		...	...	010	<b>83126</b> <b>89430</b>
60 - 62	Autobús Escolar y Camión Estándar y Heavy Duty (2 Ton)	....		...	...	010	<b>83221</b> ...
71 - 72	Cabina Convencional & Abatible con Ejes de 9000 & 11000 lb	22012095		...	...	010	<b>83126</b> <b>89430</b>
		4940606		...	...	010	<b>83126</b> <b>89430</b>
76 - 89	Chasis C, M - Cabina Convencional	22002294	010	<b>83304</b>	...	...	...
		22007752	010	<b>83304</b>	...	...	...
73 - 75	Chasis C, M, S - Cabina Convencional con Eje 5000 & 7000 lb	22007750	010	<b>83207</b>	<b>89407</b>	...	...
		4975467	010	<b>83207</b>	<b>89407</b>	...	...
		4975494	010	<b>83207</b>	<b>89407</b>	...	...
75 - 80	Chasis C, M, S - Cabina Convencional y Autobús Escolar	4975510	010	<b>83221</b>	...	...	...
79 - 89	Chasis C, S - Cabina Convencional y Autobús Escolar	22002295	010	<b>83303</b>	...	...	...
		22007753	010	<b>83303</b>	...	...	...
		22017530	010	<b>83303</b>	...	...	...
		22017531	010	<b>83303</b>	...	...	...
73 - 89	Chasis C, S - Cabina Convencional y Autobús Escolar - Exc. Eje Trasero 20800 & 23000 lb	22012096		...	...	010	<b>83221</b> ...
		22012169		...	...	010	<b>83221</b> ...
		3192892		...	...	010	<b>83221</b> ...
73 - 89	Chasis C, S - Cabina Convencional y Autobús Escolar con Eje Trasero 20800 & 23000 lb	22012095		...	...	010	<b>83126</b> <b>89430</b>
		22012166		...	...	010	<b>83126</b> <b>89430</b>
		4940606		...	...	010	<b>83126</b> <b>89430</b>
73 - 80	Chasis C, S, T - Cabina Convencional & Abatible, y Autobús Escolar con Eje 5000 & 7000 lb	22002293	010	<b>83126</b>	<b>89430</b>	...	...
		22007701	010	<b>83126</b>	<b>89430</b>	...	...
		22007751	010	<b>83303</b>	...	...	...
		22012095	010	<b>83126</b>	<b>89430</b>	...	...
		3192890	010	<b>83126</b>	<b>89430</b>	...	...
		4940606	010	<b>83126</b>	<b>89430</b>	...	...
		4940662	010	<b>83126</b>	<b>89430</b>	...	...
		4975497	010	<b>83126</b>	<b>89430</b>	...	...
79 - 80	Chasis W - Cabina Abatible BBC de 72"	22002293	010	<b>83126</b>	<b>89430</b>	...	...
		22007751	010	<b>83303</b>	...	...	...
68	Cowl - Exc. Autobús Escolar	22012096	010	<b>83221</b>	...	...	...
69 - 70	D - D Forward Control con Ejes de 9000 & 11000 lb - Exc. Cabina Abatible	3192892	010	<b>83221</b>	...	...	...
		3192892	010	<b>83221</b>	...	...	...
69 - 72	S-60	3192892	010	<b>83221</b>			
73 - 78	S-60	4975510	010	<b>83221</b>	...	...	...
73 - 78	S-60 con Frenos de Aire	22007701		...	...	010	<b>83126</b> <b>89430</b>
		22007751		...	...	010	<b>83303</b> ...

**GUÍA DE APLICACIONES – CAMIONES, TRÁILERS Y AUTOBUSES**

Año	Modelo	# E.O.	Delantero		Trasero	
						
			Fleetline	GasSLX	Fleetline	GasSLX

**CHEVROLET TRUCK (VER TAMBIÉN GMC) (Cont.)**





**Series 6, 60, 6000 & 6500 (Cont.)**

73 - 78	S-60 con Frenos de Aire	22012095		...	...	010	83126	89430
		22012166		...	...	010	83126	89430
		3171069		...	...	010	85304	...
		4940606		...	...	010	83126	89430
73 - 75	SE, SS-60 hasta No. de Serie 134487 (1er Diseño de 1975)	22007700	010	83207	89407		...	...
		22007750	010	83207	89407		...	...
		4975467	010	83207	89407		...	...
		4975494	010	83207	89407		...	...
76 - 78	SE-60 con Frenos Hidráulicos desde No. de Serie 120000 (2do Diseño de 1975)	22012169		...	...	010	83221	...
		3192892		...	...	010	83221	...
76 - 78	SE-60 desde No. de Serie 120000 (2do Diseño de 1976)	22002294	010	83304	...		...	...
		22007752	010	83304	...		...	...
73 - 74	SG, SM-60	3192890	010	83126	89430		...	...
73 - 74	SG, SM-61	4940606	010	83126	89430		...	...
73 - 74	SG, SM-62	22002293	010	83126	89430		...	...
73 - 74	SG, SM-63	22007701	010	83126	89430		...	...
73 - 74	SG, SM-64	22007751	010	83303	...		...	...
71 - 72	TDM Detroit Diesel 4 Ciclos con Eje Tarjeta	22012095		...	...	010	83126	89430
		4940606		...	...	010	83126	89430
67 - 68	TDM Detroit Diesel 4 Ciclos con Eje Tarjeta - Exc. Cabina Abatible	22012096		...	...	010	83221	...
		3192892		...	...	010	83221	...
69 - 72	Todos - Exc. Cabinas Abatibles	22012096	010	83221				
		3192892	010	83221				
68 - 69	Todos con Ejes 9000 lb & 11000 lb - Exc. Cabina Abatible	22012095	010	83126	89430		...	...
		4940606	010	83126	89430		...	...

**Series 7, 70 & 7000**

66 - 72	Cabina Convencional BBC de 92"	3192657	010	83216	...		...	...
		4940614	010	83216	...		...	...
		4963854	010	83216	...		...	...
66 - 72	Cabina Convencional con Muelles de 2 Hojas Softride de 11000 lb y Eje F120 (12000 lb)	22046483	010	85304	...		...	...
		22052336	010	85304	...		...	...
		3171069	010	85304	...		...	...
66 - 72	Cabina Convencional con Muelles de 2 Hojas Softride de 7000 & 9000 lb y Eje F070, F090, F120 (7000, 9000, 12000 lb)	3171068	010	83216	...		...	...
		3192657	010	83216	...		...	...
		4940614	010	83216	...		...	...
		4963853	010	83216	...		...	...
		4963854	010	83216	...		...	...
66 - 72	Cabina Metálica Abatible BBC de 72" con Motor de Ciclo Diesel V-6 2	22012095	010	83126	89430		...	...
		3171462	010	83126	89430		...	...
		3192890	010	83126	89430		...	...
66 - 72	Cabina Metálica Abatible BBC de 72" con Motor de Ciclo Diesel V-6 2 con Eje 17201 y 17221	22012096		...	...	010	83221	...
		3192892		...	...	010	83221	...
66 - 72	Cabina Metálica Abatible BBC de 72" con Motor de Ciclo Diesel V-6 2 con Eje 19101 y 19201	4940600		...	...	010	83209	89414
79 - 89	Chasis C, M - Cabina Convencional BBC de 97"	22002294	010	83304	...		...	...
		22002295	010	83303	...		...	...
		22007752	010	83304	...		...	...
		22007753	010	83303	...		...	...
		22012095		...	...	010	83126	89430
		22012166		...	...	010	83126	89430
		22017530	010	83303	...		...	...

**GUÍA DE APLICACIONES – CAMIONES, TRÁILERS Y AUTOBUSES**

Año	Modelo	# E.O.	Delantero		Trasero	
						
			Fleetline	GasSLX	Fleetline	GasSLX

**CHEVROLET TRUCK (VER TAMBIÉN GMC) (Cont.)**

**Series 7, 70 & 7000 (Cont.)**

79 - 89	Chasis C, M - Cabina Convencional BBC de 97"	22017531	010	83303	...		...	...
83 - 84	Chasis con Forward Control STT042	22012065	010	85304	...		...	...
		3171069	010	85304	...		...	...
83 - 84	Chasis Forward Control S7T042 con Eje Trasero de 17000, 18500, 21000, 23000 lb	22012095		...	...	010	83126	89430
		22012166		...	...	010	83126	89430
77 - 80	Chasis H, J - Cabina Convencional BBC de 92"	4963854	010	83216	...		...	...
		4984526	010	83216	...		...	...
73 - 80	Chasis H, J - Cabina Convencional BBC de 92" & 114"	2204683	010	85304	...		...	...
		3171069	010	85304	...		...	...
73 - 80	Chasis H, J - Cabina Convencional BBC de 92" con Motores V-6, V8 a Diesel	4940614	010	83216	...		...	...
		4963854	010	83216	...		...	...
73 - 80	Chasis R - Autobús con Motor Atrás	22012090	010	85308	89422		...	...
		5552451	010	85308	89422		...	...
		5552456		...	...	010	85307	...
		5552552		...	...	010	85303	89422
73 - 80	Chasis T, W - Cabina Abatible BBC de 72" (4 x 2) con Motor V-6 a Diesel	22007751	010	83303	...		...	...
		22012095	010	83126	89430		...	...
		4940606	010	83126	89430		...	...
		4975497	010	83126	89430		...	...
73 - 80	Chasis T, W - Cabina Abatible BBC de 72" con Motor V-6 a Gas	22012091	010	85303	89422		...	...
		5552452	010	85303	89422		...	...

**Series 8, 80 & 8000**

66 - 72	Cabina Convencional BBC de 92"	3171068	010	83216	...		...	...
		3192657	010	83216	...		...	...
		4940614	010	83216	...		...	...
		4963853	010	83216	...		...	...
		4963854	010	83216	...		...	...
66 - 72	Cabina Convencional BBC de 92" con Ejes de 7000 & 9000 lb - Exc. Muelles Sofride de 2 Hojas	22046483	010	85304	...		...	...
		22052336	010	85304	...		...	...
		3171069	010	85304	...		...	...
66 - 69	Cabina Metálica Abatible BBC de 72"	5544060	010	85302	89420		...	...
78 - 81	Chasis H, J - Cabina Convencional BBC de 92"	4963854	010	83216	...		...	...
		4984526	010	83216	...		...	...
73 - 86	Chasis H, J - Cabina Convencional BBC de 92" & 114"	22046483	010	85304	...		...	...
		22052336	010	85304	...		...	...
		3171069	010	85304	...		...	...
79 - 82	Chasis H, J - Cabina Convencional BBC de 92" 4 x 2 con Suspensión de Aire	22012065		...	...	010	85304	...
		22046483		...	...	010	85304	...
		22052336		...	...	010	85304	...
		3171069		...	...	010	85304	...
73 - 81	Chasis H, J - Cabina Convencional BBC de 92" con Motor V-6 a Gas	4940614	010	83216	...		...	...
		4963854	010	83216	...		...	...
73 - 80	Chasis R - Autobús con Motor Atrás	22012090	010	85308	89422		...	...
		22012091		...	...	010	85303	89422
		5552451	010	85308	89422		...	...
		5552452		...	...	010	85303	89422
		5552456		...	...	010	85307	...
70 - 80	Chasis T, W - Cabina Abatible BBC de 72" con Motor V-6 a Gas	22012091	010	85303	89422		...	...
		5552452	010	85303	89422		...	...

## GUÍA DE APLICACIONES – CAMIONES, TRÁILERS Y AUTOBUSES

Año	Modelo	# E.O.	Delantero		Trasero	
			Fleetline	GasSLX	Fleetline	GasSLX

### CHEVROLET TRUCK (VER TAMBIÉN GMC) (Cont.)

#### Series 9000 (Cont.)

<b>70 - 72</b>	Cabina Abatible BBC Aluminum 6 x 4 de 54"	22046483	010	<b>85304</b>		
		22052336	010	<b>85304</b>		
		3171069	010	<b>85304</b>		
<b>70 - 72</b>	Cabina Convencional BBC 6 x 4 de 92" & 114"	22046483	010	<b>85304</b>		
		22052336	010	<b>85304</b>		
		3171069	010	<b>85304</b>		
<b>70 - 72</b>	Cabina Convencional BBC de 92" & 114" Exc. 6 x 4	4940614	010	<b>83216</b>	...	...
		4963854	010	<b>83216</b>	...	...
<b>70 - 86</b>	Chasis D, F - Cabina de Aluminio Abatible BBC de 54" con Suspensión de Aire Trasera GM (4 Piezas)	22012065	010	<b>85304</b>		
		22046483	010	<b>85304</b>		
		22052336	010	<b>85304</b>		
		3171069	010	<b>85304</b>		
<b>70 - 86</b>	Chasis H, J - Cabina Convencional BBC de 92"	22046483	010	<b>85304</b>	...	...
		22052336	010	<b>85304</b>	...	...
		3171069	010	<b>85304</b>	...	...
<b>77 - 86</b>	Chasis M, N - Cabina Convencional BBC de 114" & BBC de Aluminio de 108" con Suspensión Trasera GM Air-Ride (4 amortiguadores)	22012065	010	<b>85304</b>		
		22046483	010	<b>85304</b>		
		22052336	010	<b>85304</b>		
		3171069	010	<b>85304</b>		
<b>70 - 80</b>	Chasis T, W - Cabina Abatible BBC de 72"	22012091	010	<b>85303</b>	89422	...
		5552452	010	<b>85303</b>	89422	...





#### Series B - Autobús Escolar

<b>90 - 98</b>	Chasis Autobús Escolar Modelo B7 con Muelles de 11000, 13500, 15000 lb con Muelles Multihojas de 15000, 19000, 21000 lb	22064231					
		15174902			- -	<b>85324</b>	...
		22064232			- -	<b>85071</b>	...
	Modelos con Número de E.O.	15123676	- -	<b>83136</b>	...	...	...
		15588554	- -	<b>83136</b>	...	...	...
		22064230	- -	<b>83136</b>	...	...	...
		88982682	- -	<b>83136</b>	...	...	...

#### Series C - (C4500, C5500) Kodiak

<b>90 - 09</b>	Chasis C - Cabina Convencional Amortiguador Delantero con Número de E.O.  con Muelles Multihojas de 15000, 19000, 21000 lb	15123676	- -	<b>83136</b>	...	...	...
		15588554	- -	<b>83136</b>	...	...	...
		15887728	- -	<b>83136</b>	...	...	...
		19152843	- -	<b>83136</b>	...	...	...
		22064230	- -	<b>83136</b>	...	...	...
		88982682	- -	<b>83136</b>	...	...	...
		15174902			- -	<b>85071</b>	...
		22064232			- -	<b>85071</b>	...
		88982686			- -	<b>85071</b>	...
<b>04 - 09</b>	Chasis C - Cabina Convencional (Sin Opción 4x4) con Muelles Multihojas de 13,500 lb	15185644			010	<b>83155</b>	...
		508-89			010	<b>83155</b>	...
		L-12706			010	<b>83155</b>	...
<b>83 - 99</b>	Chasis C - Cabina Convencional con Eje Trasero 9100 a 17500 lb	22064432			010	<b>85050</b>	...
<b>90 -</b>	Chasis C - Cabina Convencional con Muelles de 11000, 13500, 15000 lb	22064231			- -	<b>85324</b>	...
<b>90 - 06</b>	Chasis C - Cabina Convencional con Muelles de 16900 o 17850 lb	21998392			- -	<b>85336</b>	...
		22064489			- -	<b>85336</b>	...
		88963409			- -	<b>85336</b>	...

**GUÍA DE APLICACIONES – CAMIONES, TRÁILERS Y AUTOBUSES**

Año	Modelo	# E.O.	Delantero		Trasero	
						
			Fleetline	GasSLX	Fleetline	GasSLX

**CHEVROLET TRUCK (VER TAMBIÉN GMC) (Cont.)**

**Series C - (C4500, C5500) Kodiak (Cont.)**

90 -	Chasis C - Cabina Convencional con Muelles de 19000, 21000, 23000 lb (Exc. Vehículos Perfil Bajo)	22064233		...	...	- -	83136	...
03 - 09	Chasis C - Cabina Convencional con Suspensión Trasera de Muelles	15185643		...	...	0 0	83153	...
	Modelos con Número de E.O.	88982684	- -	83136	...		...	...
		88982686		...	...	- -	85071	...
		88982688		...	...	- -	85336	...

**Series C - (C6500, C7500, C8500) Kodiak**

04 - 08	Cabina Convencional (Perfil Bajo) con Muelles de 12000, 15000, & 17000 lb	15174901		...	...	- -	85342	...
		507-22		...	...	- -	85342	...
		88982685		...	...	- -	85342	...
90 -	Cabina Convencional c/ Muelles de 19000, 21000, 23000 lb (Exc. Perfil Bajo)	22064233		...	...	- -	83136	...
90 - 09	Cabina Convencional con Amortiguador Delantero Número de E.O.	15123676	- -	83136	...		...	...
		15174898	- -	83136	...		...	...
		15588554	- -	83136	...		...	...
		15887728	- -	83136	...		...	...
		19152843	- -	83136	...		...	...
		22064230	- -	83136	...		...	...
		88982682	- -	83136	...		...	...
83 - 99	Cabina Convencional con Eje Trasero de 9100 lb a 17500 lb	22064432		...	...	0 0	85050	...
90 -	Cabina Convencional con Muelles de 11000, 13500, 15000 lb	22064231		...	...	- -	85324	...
90 - 06	Cabina Convencional con Muelles de 16900 o 17850 lb	21998392		...	...	- -	85336	...
		22064489		...	...	- -	85336	...
		88963409		...	...	- -	85336	...
04 - 08	Cabina Convencional con Muelles de 19000 lb	15174903		...	...	- -	85342	...
		507-23		...	...	- -	85342	...
		88982687		...	...	- -	85342	...
90 - 09	Cabina Convencional con Muelles Multihojas de 15000, 19000, 21000 lb	15174902		...	...	- -	85071	...
		22064232		...	...	- -	85071	...
		88982686		...	...	- -	85071	...
95 - 99	Modelos con Suspensión de Aire Hendrickson (No. de Estampado 47902-13)	12474915		...	...	0 0	83122	89406
		15963161		...	...	0 0	83122	89406
96 - 99	Modelos con Suspensión de Aire Hendrickson (No. de Estampado 47902-29)	12474917		...	...	0 0	83121	...
		15740554		...	...	0 0	83121	...
	Modelos con Número de E.O.	88982684	- -	83136	...		...	...
		88982688		...	...	- -	85336	...

**Series P**





92 - 96	Chasis Motorhome	22064231		...	...	- -	85324	...
		22064233		...	...	- -	83136	...

**Series T (T5500, T6500, T7500, T8500)**

90 - 06	Cabina Abatible con Muelles Multihojas de 15000, 19000, 21000 lb	15174902		...	...	- -	85071	...
		22064232		...	...	- -	85071	...
92 - 06	Cabina Abatible con Muelles Taperleaf 16900 lb	21998392		...	...	- -	85336	...
		22064489		...	...	- -	85336	...
		88963409		...	...	- -	85336	...
92 - 99	Cabina Abatible con Muelles Taperleaf 19000, 21000, 23000 lb (Exc. Perfil Bajo)	22064233		...	...	- -	83136	...
90 - 99	Cabina Abatible con Muelles Taperleaf de 11000, 13500, 15000 lb	22064231		...	...	- -	85324	...
97 -	Cabina Abatible FL1 con Eje de 8100 lb	22064804	- -	83136	...		...	...
		22064805	- -	83136	...		...	...



**GUÍA DE APLICACIONES – CAMIONES, TRÁILERS Y AUTOBUSES**

Año	Modelo	# E.O.	Delantero		Trasero	
						
			Fleetline	GasSLX	Fleetline	GasSLX

**CHEVROLET TRUCK (VER TAMBIÉN GMC) (Cont.)**

**Series T (T5500, T6500, T7500, T8500) (Cont.)**

97 -	Cabina Abatible FL1 con Eje de 8100 lb	22165187	-I-	83136	...		...	...
		22165188	-I-	83136	...		...	...
97 -	Cabina Abatible FL2 con Eje de 5000 a 11000 lb	22064807	-I-	83136	...		...	...
		22166442	-I-	83136	...		...	...
97 -	Cabina Abatible FL3 con Eje de 14575 lb	22064806	-I-	83136	...		...	...
		22165189	-I-	83136	...		...	...
99	Modelos con Suspensión de Aire Hendrickson (No. de Estampado 47902-13)	12474915		...	...	O O	83122	89406
		15963161		...	...	O O	83122	89406
06 - 09	Modelos de Cabina Abatible con Número de E.O.	15174901		...	...	-I-	85342	...
		15174903		...	...	-I-	85342	...
		507-22		...	...	-I-	85342	...
		507-23		...	...	-I-	85342	...
		88982685		...	...	-I-	85342	...
		88982687		...	...	-I-	85342	...





**Series W (Isuzu)**

89 - 90	Flatflow Modelos W4	9-51630-647-1	-I O	G63616	...		...	...
89 - 92	Flatflow Modelos W4	9-51630-666-0		...	...	O O	85012	89413
		9-51630-666-2		...	...	O O	85012	89413
83 - 95	Modelos W4	9-51630-666-0		...	...	O O	85012	89413
		9-51630-666-2		...	...	O O	85012	89413
86 - 90	Modelos W4	8-94454-986-0	-I O	G63616	...		...	...
		8-94454-987-0	-I O	G63616	...		...	...
		9-51630-647-1	-I O	G63616	...		...	...
86 - 95	Modelos W4 con Suspensión de 11000 lb	97083027	-I O	G63616	...		...	...
09/88-08/92	Modelos W4 con Suspensión de 13000 lb	94454987	-I O	G63616	...		...	...
09/92 -	Modelos W4 con Suspensión de 13000 lb	97083029	-I O	G63616	...		...	...
87- 95	Modelos W4 con Suspensión de 13000 lb	97083029	-I O	G63616	...		...	...
88 - 97	Modelos W5	1-51630-217-0	-I O	83114	...		...	...
		1-51630-217-1	-I O	83114	...		...	...
		1-51630-219-1	-I O	83114	...		...	...
86 - 91	Modelos W6	1-51630-168-1	-I O	G63610	...		...	...
		1-51630-217-0	-I O	83114	...		...	...
		1-51630-217-1	-I O	83114	...		...	...
	Modelos con Número de E.O.	8-94057-593-0	-I O	83114	...		...	...
		8-97201-960-0	-I O	G63616	...		...	...
		94033786	-I O	83114	...		...	...
		94051090	-I O	83114	...		...	...
		94057593	-I O	83114	...		...	...
		97201960	-I O	G63616	...		...	...

**Intercambios Adicionales de E.O.**

	Modelos con Número de E.O.	15642943		...	...	-I-	83136	...
		22046489	O O	85303	89422		...	...
		22065218	O O	G63347	...		...	...
		22065251	O O	85030	89440		...	...
		22099889		...	...	-I-	85336	...
		507-24		...	...	-I-	85336	...
		508-86		...	...	-I-	83136	...
		508-88		...	...	O O	83153	...
	Intercambios Adicionales de E.O.	22007703	O O				83303	
		22012067	O O				85700	
		22012079	-I-				85701	
		22012082	O O				85702	
		22012083	-I O				85711	

**GUÍA DE APLICACIONES – CAMIONES, TRÁILERS Y AUTOBUSES**





Año	Modelo	# E.O.	Delantero		Trasero	
						
			Fleetline	GasSLX	Fleetline	GasSLX

**CHEVROLET TRUCK (VER TAMBIÉN GMC) (Cont.)**

**Intercambios Adicionales de E.O. (Cont.)**

Intercambios Adicionales de E.O.	22012114	010	85700
	22012131	-10	85711
	22024062	-1-	85701
	22024673	-10	85710
	22045526	010	85702
	22046481	010	85702
	22046485	-10	85710
	22046499	-10	85710
	22052014	010	85702
	22052424	-10	85710
	3171696	010	85307
	3172948	010	85303 or 89422
	3175509	010	85735
	3178157	010	85700
	3178233	010	85734
	3178507	010	85700
	3178995	010	85700
	3188626	010	85300 or 89419
	3188729	010	85303 or 89422
	4939852	010	85308 or 89422
	4939967	010	85308 or 89422
	4940601	010	83216
	4940627	010	83203 or 89436
	4940640	010	83216
	4940650	010	83207 or 89407
	4940654	010	83216
	4940660	010	83207 or 89407
	4963844	010	85307
	4964853	010	83217
	4974401	010	85700
	4975429	010	85300 or 89419
	4975479	-1-	83400
	4975480	-1-	83400
	4975515	-1-	85701
	4975516	010	85702
	4975518	010	85704
	4975538	010	85700
	4975549	010	83216
	4975550	010	85702
	507-3	010	85307
	5171068	010	83216
	5316784	010	85700
	5316791	010	83219
	5316792	010	85305
	5316793	010	85305
	5321920	010	85307
	5321929	010	85307
5348631	010	83203 or 89436	
5352858	010	85305	
5353054	010	85303 or 89422	
5355798	010	85307	
5357955	010	85300 or 89419	
5357956	010	85734	
5357959	010	85300 or 89419	
5361994	010	85734	

**GUÍA DE APLICACIONES – CAMIONES, TRÁILERS Y AUTOBUSES**





Año	Modelo	# E.O.	Delantero		Trasero	
						
			Fleetline	GasSLX	Fleetline	GasSLX

**CHEVROLET TRUCK (VER TAMBIÉN GMC) (Cont.)**

**Intercambios Adicionales de E.O. (Cont.)**

Intercambios Adicionales de E.O.	5374779	010	<b>85308 or 89422</b>
	5374999	010	<b>85307</b>
	5385939	010	<b>85307</b>
	5392387	010	<b>85303 or 89422</b>
	5394448	010	<b>85305</b>
	5394467	010	<b>85305</b>
	5394468	010	<b>85735</b>
	5455798	010	<b>85307</b>
	5513489	010	<b>83216</b>
	5513716	010	<b>85304</b>
	5516459	010	<b>85305</b>
	5522781	010	<b>85735</b>
	5522794	010	<b>85308 or 89422</b>
	5522818	010	<b>85305</b>
	5527001	010	<b>85300 or 89419</b>
	5527271	010	<b>85700</b>
	5527272	010	<b>85700</b>
	5527606	010	<b>85305</b>
	5531027	010	<b>85301</b>
	5531435	010	<b>85307</b>
	5531436	010	<b>85307</b>
	5531437	010	<b>85307</b>
	5532026	010	<b>85304</b>
	5532425	010	<b>83207 or 89407</b>
	5532433	010	<b>83207 or 89407</b>
	5532675	010	<b>85307</b>
	5534430	010	<b>85303 or 89422</b>
	5534439	010	<b>85304</b>
	5534447	010	<b>85303 or 89422</b>
	5544112	010	<b>83216</b>
	5544581	010	<b>85302 or 89420</b>
	5544716	010	<b>85304</b>
	5544717	010	<b>85304</b>
	5544812	010	<b>83308</b>
	5544818	010	<b>85735</b>
	5549899	010	<b>83207 or 89407</b>
	5549924	010	<b>85700</b>
	5549925	010	<b>85304</b>
	5552111	010	<b>85304</b>
	5552112	010	<b>85307</b>
	5552114	010	<b>83216</b>
	5552205	010	<b>83217</b>
	5552206	010	<b>83214</b>
	5552207	010	<b>83217</b>
	5552208	010	<b>83217</b>
	5552209	010	<b>83215</b>
	5552210	010	<b>85308 or 89422</b>
5552244	010	<b>85308 or 89422</b>	
5552285	010	<b>83214</b>	
5552286	010	<b>83217</b>	
5552287	010	<b>83217</b>	
5552288	010	<b>83217</b>	
5552453	010	<b>85301</b>	
5552527	010	<b>85735</b>	
5554184	010	<b>85302 or 89420</b>	

**GUÍA DE APLICACIONES – CAMIONES, TRÁILERS Y AUTOBUSES**

Año	Modelo	# E.O.	Delantero		Trasero	
						
			Fleetline	GasSLX	Fleetline	GasSLX

**CHEVROLET TRUCK (VER TAMBIÉN GMC) (Cont.)**

**Intercambios Adicionales de E.O. (Cont.)**

Intercambios Adicionales de E.O.	5554589	010	<b>85307</b>
	5554596	010	<b>85303 or 89422</b>
	5554814	010	<b>85302 or 89420</b>
	5554959	010	<b>83401</b>
	5554995	010	<b>85305</b>
	5559363	010	<b>83203 or 89436</b>
	5585939	010	<b>85307</b>
	684280	010	<b>83209 or 89414</b>
	97-2210-00153	-1-	<b>85701</b>
	97-2210-00164	-1-	<b>85708</b>
97-2210-00170	01-	<b>85733</b>	

**CHEVROLET TRUCK AMORTIGUADORES DE CABINA**

	Cabina Abatible Titan (Camiones con y sin Dormitorio) Modelo Link Cabmate GMC-2P-A	1202-0032	010	<b>83016</b>
<b>90 -</b>	Cabinas Kodiak con Modelo Link Cabmate GMC104TK	1202-0054	010	<b>83021</b>
<b>- 89</b>	Cabinas Kodiak con Modelo Link Cabmate GMC92TK	1202-0012	010	<b>83023</b>
	Modelos con Suspensión Link Cab	1202-0022	010	<b>83046</b>
	Tractos Bruin con Cabinas J9 con Modelo Link Cabmate GMC92J9	1202-0012	010	<b>83023</b>

**CHRYSLER**

**Chasis Motorhome**

<b>63 - 72</b>	Chasis Motorhome M-300, M-375 & R-375	2961043	...	...	010	<b>G63183</b>	...
		3633744	...	...	010	<b>G63183</b>	...
<b>73 - 81</b>	M & R - Chasis Motorhome 300, 400, 500	3638112	...	...	010	<b>G63183</b>	...

**CLARK EQUIPMENT**

	Carga Vigas	355778	010	<b>85315</b>			
		680042	010	<b>85301</b>			
	Modelo 130885 (Suspensión de Aire)	5532675	...	...	010	<b>85307</b>	...

**COACHMEN RV**

**MotorHomes Clase A**

<b>03 - 05</b>	MotorHomes Cross Country Elite & SE con Chasis Freightliner XC	Amortiguador Trasero con Número de E.O.	141700131809							
			16-16736-000	...	...	010	<b>85029</b>	...		
				...	...	010	<b>85029</b>	...		
			Suspensión Delantera AS120	141700131810	010	<b>83160</b>	...	...		
				16-16737-000	010	<b>83160</b>	...	...		
				16-16874-000	010	<b>83160</b>	...	...		
			Suspensión Delantera ZF - IFS con PBV de 23,000 lb o mayor	16-18103-000	-1-	<b>85900</b>	...	...		
				481700000493	-1-	<b>85900</b>	...	...		
			Suspensión Trasera ADL200 de 20K	16-16873-000		...	...	010	<b>85029</b>	...
			<b>06</b>	MotorHomes Series Cross Country con Chasis Freightliner XC	Amortiguador Trasero con Número de E.O.	141700131809				
16-16736-000	...	...				010	<b>85029</b>	...		
	...	...				010	<b>85029</b>	...		
Suspensión Delantera AS120	141700131810	010				<b>83160</b>	...	...		
	16-16737-000	010				<b>83160</b>	...	...		
	16-16874-000	010				<b>83160</b>	...	...		
Suspensión Delantera ZF - IFS con PBV de 23,000 lb o mayor	16-18103-000	-1-				<b>85900</b>	...	...		
	481700000493	-1-				<b>85900</b>	...	...		
Suspensión Trasera ADL200 de 20K	16-16873-000					...	...	010	<b>85029</b>	...

## GUÍA DE APLICACIONES – CAMIONES, TRÁILERS Y AUTOBUSES

Año	Modelo	# E.O.	Delantero		Trasero	
			Fleetline	GasSLX	Fleetline	GasSLX

### CONTINENTAL TRAILWAYS-EAGLE INT'L

	Autobuses con Número de E.O.	6-05-5	OIO	<b>85307</b>			
	Silver Eagle	01-0100-905	OIO	<b>85303 or 89422</b>			
		5394467	OIO	<b>85305</b>			
		680091	OIO	<b>85303 or 89422</b>			
		70039	OIO	<b>85303 or 89422</b>			
		70041	OIO	<b>85305</b>			
	Modelos con Número de E.O.	01-0100-020	OIO	<b>85307</b>			
		5532026	OIO	<b>85304</b>			

### COUNTRY COACH

	Modelos con Número de E.O.	89406	OIO	...	89406	...	...
		89414		...	...	OIO	<b>89414</b>

### CRANE CARRIER

	Modelos con Número de E.O.	277A-1	OIO	<b>85307</b>	...	...	...
		277A-13	OIO	<b>85302</b>	89420	...	...
		277A-14	OIO	<b>85304</b>	...	...	...
		277A-8	OIO	<b>85303</b>	89422	...	...
		277A-9	OIO	<b>85307</b>	...	...	...
		680091	OIO	<b>85303</b>	89422	...	...
	Intercambios Adicionales de E.O.	277A-12	OIO	<b>85304</b>			
		680088	OIO	<b>85713</b>			

### CROWN COACH

	Modelos con Número de E.O.	5532036	OIO	<b>85734</b>			
	Todos con Suspensión de Resortes de Acero	3188729	OIO	<b>85303</b>	89422	...	...
		5532026	OIO	<b>85304</b>			

### CUNHA PRODUCTS OHD

	Dollies	CP-5222		...	...	OIO	<b>85315</b>	...
--	---------	---------	--	-----	-----	-----	--------------	-----

### DANA

	Dana Smart Ride - Modelos RF y RS - 20,000 lb y 23,000 lb	SR1VJ100		...	...	OIO	<b>85078</b>	...
--	---	----------	--	-----	-----	-----	--------------	-----

### DEXTER AXLE

#### Trailer

	Suspensión Slider Air 86 AR / RS 1015, 1035, 3035	18165-01		...	...	OIO	<b>85006</b>	...
--	---	----------	--	-----	-----	-----	--------------	-----





### DIAMOND T

	Modelos con Número de E.O.	5549925	OIO	<b>85304</b>	...	...	...
--	----------------------------	---------	-----	--------------	-----	-----	-----

### DIAMOND-REO

	C054, C088 con Eje FH o FL	.....	OIO	<b>85307</b>	...	...	...
	C054, C088, C114, C116 con Eje FF	220-55-1	OIO	<b>83214</b>	...	...	...
		220-55-6	OIO	<b>83214</b>	...	...	...
	C114, C116 con Eje FH o FL	220-55-2	OIO	<b>85304</b>	...	...	...
		220-55-7	OIO	<b>85304</b>	...	...	...
	DC101	220-55-2	OIO	<b>85304</b>	...	...	...
		220-55-7	OIO	<b>85304</b>	...	...	...
	Modelos C090, C090D, C101	220-55-2	OIO	<b>85304</b>	...	...	...
		220-55-7	OIO	<b>85304</b>	...	...	...
	Modelos CF	220-55-8	OIO	<b>83217</b>	...	...	...
	Todos con Suspensión Velvet	.....		...	...	OIO	<b>85307</b>
	Intercambios Adicionales de E.O.	220-S5-10		...	...	OIO	<b>85712</b>

**GUÍA DE APLICACIONES – CAMIONES, TRÁILERS Y AUTOBUSES**

Año	Modelo	# E.O.	Delantero		Trasero	
						
			Fleetline	GasSLX	Fleetline	GasSLX

**DINA**

75 - 83	Autobús Modelo D 300	510002		...	...	010	85983	...
		55002		...	...	010	85983	...
	Autobuses Foráneos Modelos F con Número de E.O. (Eje Motriz)	39390339-6		...	...	010	85307	...
11 - 13	Autobuses Outsider	1520030010		...	...	-10	83317	...
		152E030030	010	85014	...		...	...
11 - 13	Autobuses Picker	1520030010		...	...	-10	83317	...
		152E030030	010	85014	...		...	...
11 - 13	Autobuses Runner 10E	1520030010		...	...	-10	83317	...
		152E030030	010	85014	...		...	...
11 - 13	Autobuses Runner 8, 9 & 10	1520030010		...	...	-10	83317	...
		152E030030	010	85014	...		...	...
	Chasis P con Número de E.O. (Eje Motriz)	39390339-6		...	...	010	85307	...
	D 600 Magno, MC2 y Citus	....		...	...	010	85100	...
	Marco Polo Viaggio GV 1000	39380353-6	010	85716	...		...	...
	Amortiguador Delantero			...	...	010	85716	...
	Eje Tarjeta	39390340-4		...	...	010	85716	...
78 - 90	Tracto Dina 861	510002		...	...	010	85983	...
		55002		...	...	010	85983	...

**DODGE TRUCK**

**Autobuses Escolares**

61 - 71	S-400, S-500, S-600	....		...	...	010	G63183	...
72 - 73	S-500, S-600	2516009		...	...	010	G63183	...
74 - 78	S-600, S-700	3633643		...	...	010	G63183	...

**Chasis Motorhome**

63 - 72	Chasis Motorhome M-300, M-375 & R-375	2961043		...	...	010	G63183	...
		3633744		...	...	010	G63183	...
77 - 81	Chasis Motorhome M-6	3638112		...	...	010	G63183	...
		4036892	010	G63605	...		...	...
73 - 81	M & R - Chasis Motorhome 300, 400, 500	3638112		...	...	010	G63183	...
		3638631	010	G63605	...		...	...

**LN & LNT - Cabina Convencional**

64 - 72	Modelos LN, LV	2516009		...	...	010	G63183	...
---------	----------------	---------	--	-----	-----	-----	--------	-----

**LNT, LVT, NLT, VLT- Cabina Abatible 6 x 4**

64 - 73	Modelos LNT, LVT	2516009		...	...	010	G63183	...
---------	------------------	---------	--	-----	-----	-----	--------	-----

**LS & LT- Cabina Abatible de Acero**

73 - 75	LS-1000, LT-1000	2516009		...	...	010	G63183	...
---------	------------------	---------	--	-----	-----	-----	--------	-----

**Series D - Cabina Convencional 4 x 2**

74 - 78	D-500, D-600, D-700, D-800	3633643		...	...	010	G63183	...
73	D-500, D-600, D-800	2516009		...	...	010	G63183	...

**Series P - Forward Control**

72 - 82	P-300	....		...	...	010	G63183	...
63 - 78	P-400	....		...	...	010	G63183	...
63 - 71	PC-500 y PC-600, PD-500 y PD-600	....		...	...	010	G63183	...









**Series W y Power Wagons**

61 - 72	Modelos W-500, WT-500	....		...	...	010	G63183	...
73	Modelos W-600	2516009		...	...	010	G63183	...
		2960707	010	G63183	...		...	...
74 - 78	Modelos W-600	3633643		...	...	010	G63183	...

**DUPLEX TRUCK**

	Modelos con Número de E.O.	59024	010				83204	
		7604-3371	010				83204	

## GUÍA DE APLICACIONES – CAMIONES, TRÁILERS Y AUTOBUSES

Año	Modelo	# E.O.	Delantero		Trasero	
						
						
			Fleetline	GasSLX	Fleetline	GasSLX

### DURA SUSPENSION

	Modelos con Número de E.O.	1080099		...	...	010	<b>83203</b>	89436
		12866		...	...	010	<b>83207</b>	89407
		59024		...	...	010	<b>83204</b>	...
		59030		...	...	010	<b>83203</b>	89436
		665133		...	...	010	<b>83203</b>	89436
		665267		...	...	010	<b>85029</b>	...
		7604-3371		...	...	010	<b>83204</b>	...
		A-2212		...	...	010	<b>85029</b>	...

### EAGLE MOTOR COACH

	Autobuses con Muelles de Acero	5532026	010	<b>85304</b>				
	Autobuses con Suspensión con Eje de Torsión	6-05-5		...	...	010	<b>85307</b>	...
	Modelos con Número de E.O.	01-0100-020	010	<b>85307</b>				
		01-0100-905	010	<b>85303 or 89422</b>				
		014-0100-905	010	<b>85308</b>	89422		...	...
		101364	010	<b>85305</b>				
		154-0100-514	010	<b>85314</b>	89425		...	...
		5394467	010	<b>85305</b>				
		680091	010	<b>85303 or 89422</b>				
		70039	010	<b>85303 or 89422</b>				
	Intercambios Adicionales de E.O.	0140100-905	010	<b>85308 or 89422</b>				
		12B-5-1	010	<b>85735</b>				
		12J-5-10	01-	<b>85733</b>				
		690060	010	<b>85713</b>				

### EAST MANUFACTURING CORP.

	Amortiguadores con Número Estampado	A-20002		...	...	010	<b>85000</b>	89436
		A-20126		...	...	010	<b>85323</b>	89436
Es necesaria la identificación de la suspensión para determinar qué sección del catálogo referir. Posibles opciones pueden ser Chalmers, Hendrickson, Neway, Ridewell, Reyco.								
	Tráilers con número de parte East Trailer	517-05001-18		...	...	010	<b>87015</b>	...
		517-05001-23		...	...	010	<b>85005</b>	89430
		517-05006-20		...	...	010	<b>85030</b>	89440
		517-05009-14		...	...	010	<b>83125</b>	...
		517-05010-07		...	...	010	<b>83214</b>	...
		517-05022-07		...	...	010	<b>83217</b>	...
		517-05110-20		...	...	010	<b>85000</b>	89436
		517-05511-14		...	...	010	<b>83128</b>	...
		517-05805-20		...	...	010	<b>85000</b>	89436
		517-05806-20		...	...	010	<b>85029</b>	...
		517-05808-20		...	...	010	<b>85738</b>	...
		517-05809-20		...	...	010	...	89437
		517-05916-14		...	...	010	<b>83124</b>	89407

### ELDORADO NATIONAL





02 - 13	Modelos 40 Pies de Autobús Piso Bajo con Número de E.O.	13208701		...	...	- -	<b>85746</b>	...
		13208801	- -	<b>85745</b>	...		...	...

### FLEETWOOD RV

#### MotorHomes Clase A

02 - 06	MotorHomes Bounder / Discovery & Expedition con Chasis Freightliner XC							
	Amortiguador Trasero con Número de E.O.	141700131809		...	...	010	<b>85029</b>	...
	Suspensión Delantera AS120	16-16736-000	010	<b>83160</b>	...		...	...

**GUÍA DE APLICACIONES – CAMIONES, TRÁILERS Y AUTOBUSES**

Año	Modelo	# E.O.	Delantero		Trasero	
						
			Fleetline	GasSLX	Fleetline	GasSLX

**FLEETWOOD RV (Cont.)**

**MotorHomes Clase A (Cont.)**

02 - 06	Amortiguador Trasero con Número de E.O.	16-16737-000	010	83160	...		...	...
		16-16874-000	010	83160	...		...	...
	Suspensión Delantera ZF - IFS con PBV de 23,000 lb o mayor	16-18103-000	-1-	85900	...		...	...
		481700000493	-1-	85900	...		...	...
	Suspensión Trasera ADL200 de 20K	16-16873-000		...	...	010	85029	...
03 - 06	MotorHomes Excursion & Providence con Chasis Freightliner XC	Amortiguador Trasero con Número de E.O.		...	...	010	85029	...
			141700131809		...	...	010	85029
	Suspensión Delantera AS120	16-16736-000	010	83160	...		...	...
		141700131810	010	83160	...		...	...
	Suspensión Delantera ZF - IFS con PBV de 23,000 lb o mayor	16-16737-000	010	83160	...		...	...
		16-16874-000	010	83160	...		...	...
	Suspensión Trasera ADL200 de 20K	16-18103-000	-1-	85900	...		...	...
		481700000493	-1-	85900	...		...	...
		16-16873-000		...	...	010	85029	...

**FLUIDRIVE**





Modelos T950-1200, -1400, -1700	2697		...	...	010	85712	...
---------------------------------	------	--	-----	-----	-----	-------	-----

**FLXIBLE BUS**

	Autobús de 2 Pisos	....	010	85736				
	Autobús Metropolitano Articulado Modelo 870	22024062	-1-	85701	...		...	
		22024506	-10	85703	...		...	
		22025066	-10	85703	...		...	
		4975518		...	...	010	85704	...
		680320	-10	85703	...		...	
		74412		...	...	010	85704	...
		87-2519-00001	-10	85703	...		...	
		87-2519-00003	-10	85703	...		...	
		87-2520-00001		...	...	010	85704	...
		87-2520-00003		...	...	010	85704	...
		97-2201-00003	-10	85703	...		...	
		97-2201-00005	-10	85703	...		...	
		97-2201-00006	-10	85703	...		...	
		97-2201-00007	-10	85703	...		...	
		97-2201-00009	-10	85703	...		...	
		97-2210-00001		...	...	010	85704	...
		97-2210-00002		...	...	010	85704	...
		97-2210-00003		...	...	010	85704	...
		97-2210-00004		...	...	010	85704	...
		97-2210-00005		...	...	010	85704	...
97-2210-00006		...	...	010	85704	...		
97-2210-00009		...	...	010	85704	...		
		97-2210-00011		...	...	010	85704	
	Autobús Urbano - 51 Pasajeros	6-05-1	010	85736	...		...	
		6-05-2	010	85736	...		...	
		6-05-3	010	85736	...		...	
		6-05-4	010	85736	...		...	
		6-05-5	010	85307	...		...	
		6-05-6	010	85736	...		...	
		6-05-7	010	85736	...		...	
		6-05-8	010	85736	...		...	
	Autobús Urbano - 51 Pasajeros con Suspensión de Torsión	6-05-1		...	...	010	85736	
		6-05-2		...	...	010	85736	





**GUÍA DE APLICACIONES – CAMIONES, TRÁILERS Y AUTOBUSES**

Año	Modelo	# E.O.	Delantero		Trasero	
						
			Fleetline	GasSLX	Fleetline	GasSLX

**FLXIBLE BUS (Cont.)**

Autobús Urbano - 51 Pasajeros con Suspensión de Torsión	6-05-3	...	...	010	<b>85736</b>	...	
	6-05-4	...	...	010	<b>85736</b>	...	
	6-05-5	...	...	010	<b>85307</b>	...	
	6-05-6	...	...	010	<b>85736</b>	...	
	6-05-7	...	...	010	<b>85736</b>	...	
	6-05-8	...	...	010	<b>85736</b>	...	
	CNG Bus (Gas Natural)	87-2519-00002	-10	<b>85731</b>	...	...	...
		87-2519-00004	-10	<b>85731</b>	...	...	...
87-2520-00002			...	...	010	<b>85730</b>	...
87-2520-00004			...	...	010	<b>85730</b>	...
97-2201-00008		-10	<b>85731</b>	...	...	...	
97-2210-00010			...	...	010	<b>85730</b>	...
Coach de Pasajeros & Vista Modelo 29	.....	010	<b>83217</b>				
Modelos con Número de E.O.	22012067	010	<b>85700</b>				
	22012114	010	<b>85700</b>				
	22024061		...	...	010	<b>85704</b>	...
	22025067		...	...	010	<b>85704</b>	...
	22025305		...	...	010	<b>85704</b>	...
	3166657	010	<b>85700</b>				
	3192333	010	<b>85700</b>				
	6-05-13		...	...	010	<b>85304</b>	...
	6-05-9	010	<b>85304</b>	...	...	...	
	6-367-12	010	<b>85700</b>				
	6-367-14	010	<b>85700</b>				
	6-367-16	010	<b>85700</b>				
	6-367-8	010	<b>85700</b>				
	695125		...	...	010	<b>85704</b>	...
	87-2519-00001	-10	<b>85703</b>	...	...	...	
	97-2201-00001	-10	<b>85703</b>	...	...	...	
	97-2201-00002	-10	<b>85703</b>	...	...	...	
	97-2201-00004	-10	<b>85703</b>	...	...	...	
	97-2201-00151	010	<b>85700</b>				
	97-2210-00170	01-	<b>85733</b>				
97-9999-02592	-10	<b>85710</b>	...	...	...		
Intercambios Adicionales de E.O.	015813	-1-	<b>85708</b>				
	06-0367-00151	010	<b>85700</b>				
	06-0367-00156	010	<b>85702</b>				
	06-0367-00157	-1-	<b>85701</b>				
	48-1-239	010	<b>85736</b>				
	48-1-241	010	<b>85712</b>				
	6-05-10	010	<b>85734</b>				
	6-367-1	-10	<b>85711</b>				
	6-367-11	-10	<b>85711</b>				
	6-367-17	010	<b>85700</b>				
	6-367-2	010	<b>85736</b>				
	6-367-3	010	<b>85304</b>				
	6-367-4	010	<b>83217</b>				
	6-367-6	-10	<b>85711</b>				
	6-367-7	010	<b>85305</b>				
	6-367-9	-10	<b>85711</b>				
	680029	010	<b>85301</b>				
	680155	010	<b>85712</b>				
	97-2210-00153	-1-	<b>85701</b>				
	97-2210-00156	010	<b>85702</b>				
97-2210-00157	-1-	<b>85708</b>					

**GUÍA DE APLICACIONES – CAMIONES, TRÁILERS Y AUTOBUSES**

Año	Modelo	# E.O.	Delantero		Trasero	
						
			Fleetline	GasSLX	Fleetline	GasSLX

**FLXIBLE BUS (Cont.)**

Intercambios Adicionales de E.O.	97-2210-00160	- -	<b>85705 or 89447</b>
	97-2210-00162	- -	<b>85701</b>
	97-2210-00164	- -	<b>85708</b>
	97-9999-00732	- -	<b>85707</b>
	97-9999-00807	0 0	<b>85307</b>
	97-9999-02514	0 0	<b>85700</b>
	97-9999-02515	0 0	<b>85702</b>
	97-9999-02516	- -	<b>85701</b>
	97-9999-02519	- -	<b>85707</b>
	97-9999-02595	0 0	<b>85313</b>
	97-9999-02632	- 0	<b>85711</b>
	97-9999-02633	- 0	<b>85311 or 89424</b>
	97-9999-02634	0 -	<b>85733</b>
	97-9999-02635	0 0	<b>85718</b>
	97-9999-02636	0 0	<b>85716</b>

**FLYER INDUSTRIES**

	Autobús Foráneo con Piso Bajo	15813		...	...	- -	<b>85708</b>	...
<b>91 -</b>	Autobús Foráneo con Piso Bajo	009863	- -	<b>85722</b>	...		...	...
	Intercambios Adicionales de E.O.	015915	- 0				<b>85711</b>	
		22012067	0 0				<b>85700</b>	
		22012114	0 0				<b>85700</b>	
		3166657	0 0				<b>85700</b>	
		3192333	0 0				<b>85700</b>	
		4975501	0 0				<b>85700</b>	
		4975552	- 0				<b>85711</b>	
		592-6568	0 0				<b>85700</b>	
		5979574	0 0				<b>85700</b>	

**FORD**













**Chasis Motorhome**

<b>00 - 03</b>	Chasis Motorhome F53 con Número de E.O.	1C34-18045-AA	0 0	<b>83209</b>	...		...	...
		1C34-18045-JA	0 0	<b>83209</b>	...		...	...
		AT-766	0 0	<b>83209</b>	...		...	...
<b>03 - 07</b>	Chasis Motorhome F53 con Número de E.O.	ASH-1023		...	...	0 0	<b>83122</b>	...
		ASH-137		...	...	0 0	<b>83122</b>	...
<b>04 - 07</b>	Chasis Motorhome F53 con Número de E.O.	ASH-1022	0 0	<b>83209</b>	...		...	...
		ASH-294	0 0	<b>83209</b>	...		...	...
<b>99 - 02</b>	Chasis Motorhome F53 con Número de E.O.	AT-621		...	...	0 0	<b>83122</b>	...
<b>08 - 14</b>	Chasis Motorhome F53 con PBV 16,000 lb a 22,000 lb	9U94-18045-AA	0 0	<b>83209</b>	...		...	...
		9U9Z-18124-A	0 0	<b>83209</b>	...		...	...
		ASH-1228	0 0	<b>83209</b>	...		...	...
<b>08 - 13</b>	Chasis Motorhome F53 con PBV 20,500 lb a 22,000 lb	9U94-18080-AA		...	...	0 0	<b>83122</b>	...
		9U9Z-18125-A		...	...	0 0	<b>83122</b>	...
		ASH-1230		...	...	0 0	<b>83122</b>	...
<b>73 - 76</b>	Chasis Motorhome M-400 & M-500	.....	0 0	<b>85012</b>	<b>89413</b>	0 0	<b>83225</b>	...
<b>57 - 76</b>	Chasis Motorhome P-400 & 4000 con Muelles H.D.	.....	0 0	<b>85012</b>	<b>89413</b>		...	...

**L, LT & LTS - Cabina Convencional**

<b>73 - 90</b>	L-800, L8000, L-900, L-9000, LT-800, LT-880, LT8000, LT-900, LT-9000 y Ejes de 7000, 9000, 12000 lb	D2EF-18045-AA	0 0	<b>83312</b>	<b>89409</b>		...	...
		D2KF-18045-AA	0 0	<b>83312</b>	<b>89409</b>		...	...
		D7HF-18045-FA	0 0	<b>83312</b>	<b>89409</b>		...	...
		D7HT-18045-BA	0 0	<b>83312</b>	<b>89409</b>		...	...
<b>73 - 85</b>	L-800, L8000, L-900, L-9000, LT-800, LT-880, LT8000, LT-900, LT-9000, LTS-8000, LTS-900, LTS-9000 con Ejes de 7000, 9000, 12000, 16000 lb	D2HF-18045-AA	0 0	<b>83314</b>	...		...	...

## GUÍA DE APLICACIONES – CAMIONES, TRÁILERS Y AUTOBUSES

Año	Modelo	# E.O.	Delantero				Trasero			
										
										
Fleetline		GasSLX		Fleetline		GasSLX				

### FORD (Cont.)

#### L, LT & LTS - Cabina Convencional (Cont.)

73 - 85	L-800, L8000, L-900, L-9000, LT-800, LT-880, LT8000, LT-900, LT-9000, LTS-8000, LTS-900, LTS-9000 con Ejes de 7000, 9000, 12000, 16000 lb	D2HT-18045-CA	OIO	83314	...	...	...	...
73 - 90	L-800, L850, L-900, L-9000, LT-800, LT-850, LT880, LT-900, LT-9000, LTS-800, LTS-850, LTS-900 con Ejes de 7000, 9000, 12000, 16000 lb	D2HF-18045-BA	OIO	83309	89446	...	...	
		D7HT-18045-DA	OIO	83309	89446	...	...	
91 - 97	L-8000, L-9000, LT-8000, LT-9000 con Muelles Multihojas	F1HT-18045-DA	OIO	83312	89409	...	...	
90 - 97	L-8000, L-9000, LT-8000, LT-9000 con Muelles Taperleaf de 52"	F1HT-18045-GA	OIO	85006	89401	...	...	
91 - 92	L-8000, L-9000, LT-8000, LT-9000 con Muelles Taperleaf de 52"	F1HT-18045-GB	OIO	...	89403	...	...	
90 - 97	L-8000, L-9000, LT-8000, LT-9000 con Muelles Taperleaf Parabólicas de 58"	F1HT-18045-RA	OIO	...	89441	...	...	
		F1HT-18045-RB	OIO	...	89402	...	...	
91 - 97	L-8000, L-9000, LT-8000, LT-9000 Muelles Multihojas de 4000, 4500, 5400, 6000, 7200 lb y Eje de 9000, 10000, 12000 o 16000 lb	F1HT-18045-CB	OIO	83216	...	...	...	
91 - 97	L-8000, L-9000, LT-8000, LT-9000 Muelles Multihojas de 4500, 5400, 6000, 7200, 10000 lb y Eje de 10000, 12000, 13200, 16000 lb	F1HT-18045-DB	OIO	83308	...	...	...	
73 - 89	LTS-800, LTS-850, LTS-900, LTS-9000 con Eje de 16000 lb	D0HA-18045-E	OIO	83312	89409	...	...	
		D2HF-18045-DA	OIO	83312	89409	...	...	
		D7HT-18045-EA	OIO	83312	89409	...	...	
94 - 97	Modelos L-8000, L-9000, LT-8000 o LT-9000 con Muelles Taperleaf de 46" y 21000 o 23000 lb	F4HT-18080-BA		...	...	OIO	85001	89410
	Modelos L-8000, L-9000, LT-8000 o LT-9000 con Suspensión de Aire Trasera Hendrickson	47902-13		...	...	OIO	83122	89406

#### LA, LS & LST - Cabina Convencional

90 - 97	LA-8000, LS-8000, LST-8000 con Muelles Taperleaf de 52"	F1HT-18045-EA	OIO	...	89402	...	...	
91 - 96	LA-8000, LS-8000, LST-8000 con Muelles Taperleaf de 58"	F1HT-18045-EB	OIO	...	89402	...	...	
96	Modelos LA-8000 con Ejes de 12000 o 13000 lb	F6HT-18045-LA	OIO	85376	...	...	...	
96	Modelos LA-8000 con Muelles Multihojas de 16000 lb	F6HT-18045-AA	OIO	85054	89438	...	...	
91 - 96	Modelos LA-8000 o LA-9000 con Suspensión de Aire Trasera Hendrickson	47902-28		...	...	OIO	85013	89414
91 - 96	Modelos LA-8000, LA-9000 con Muelles Multihojas de 4000, 4500, 5400, 6000, o 7200 lb	F1HT-18045-CB	OIO	83216	...	...	...	
90 - 97	Modelos LA-8000, LA-9000, LS-8000, LST-8000 con Muelles Multihojas de 4500 a 10000 lb	F1HT-18045-CA	OIO	83308	...	...	...	





#### LL, LLA, LTA, LTL, LTLA - Cabina Convencional

91 - 95	LL-9000 con Muelles de 4500, 5000, 6000 lb y Ejes de 10000, 11000, 12000 lb	F1HT-18045-DB	OIO	83308	...	...	...	
91 - 96	LL-9000, LLA-9000, LTA-9000, LTLA-9000 Muelles Multihojas de 4000, 4500, 5400, 6000 o 7200 lb y Eje de 9000, 10000, 12000 o 16000 lb	F1HT-18045-CB	OIO	83216	...	...	...	
90	LLA-9000, LTLA-9000 con Muelles Taperleaf Parabólicas de 58" y 4500, 5400, 6500 lb	FOHT-18045-CA	OIO	85006	89401	...	...	
91 - 95	LLA-9000, LTLA-9000 con Muelles Taperleaf Parabólicas de 58" y 4500, 5400, 6500 lb	F1HT-18045-CB	OIO	83216	...	...	...	
91 - 96	LLA-9000, LTLA-9000 con Muelles Taperleaf Parabólicas de 58" y 4500, 5400, 6500 lb	F1HT-18045-HB	OIO	85006	89401	...	...	
80 - 85	LTL-900, LTL-9000 con Eje de 7000, 9000, 12000 lb	D2HF-18045-AA	OIO	83314	...	...	...	
91 - 96	Modelos LTA-9000, LLA-9000 o LTLA-9000 con Muelles Multihojas de 4500, 5400, 6000, 7200 o 10000 lb	F1HT-18045-CA	OIO	83308	...	...	...	
91 - 96	Modelos LTA-9000, LLA-9000 o LTLA-9000 con Suspensión Trasera de Aire Hendrickson	47902-28		...	...	OIO	85013	89414

#### LN & LNT - Cabina Convencional

72	LN-500, LN-550 con Ejes de 11000, 13000, 15000, 17000 lb	D2TF-18080-HA	...	...	...	OIO	83225	...
70 - 72	LN-500, LN-550 con Ejes de 5000, 5500, 6000 & 7000 lb	D2TF-18045-GA	OIO	83308	...	...	...	
72 - 79	LN-600, LN-650, LN-700, LN-750 con Ejes de 11000, 13000, 15000, 17000 lb	D2TF-18080-HA		...	...	OIO	83225	...
70 - 79	LN-600, LN-650, LN-700, LN-750 con Ejes de 5000, 5500, 6000 & 7000 lb	D7HT-18045-GA	OIO	83308	...	...	...	
76 - 79	LN-600, LN-650, LN-700, LN-800	D2EF-18045-AA	OIO	83312	89409	...	...	

**GUÍA DE APLICACIONES – CAMIONES, TRÁILERS Y AUTOBUSES**

Año	Modelo	# E.O.	Delantero		Trasero	
						
			Fleetline	GasSLX	Fleetline	GasSLX

**FORD (Cont.)**

**LN & LNT - Cabina Convencional (Cont.)**

76 - 79	LN-600, LN-650, LN-700, LN-800	D7HT-18045-BA	010	83312	89409		...	...
80 - 89	LN-600, LN-700, LN-7000, LN-800, LN-8000, LNT-800, LNT-8000 con Muelles de 3000, 3300 lb y Ejes de 5000, 5500, 6000, 7000 lb	D7HT-18045-GA	010	83308	...		...	...
80 - 89	LN-600, LN-700, LN-7000, LN-800, LN-8000, LNT-800, LNT-8000 con Muelles de 4400 lb y Ejes de 7000, 9000 lb	D2EF-18045-AA	010	83312	89409		...	...
80 - 89	LN-600, LN-700, LN-750 con Ejes de 11000, 13000, 15000, 17000 lb	D7HT-18080-BA		...	...	010	83225	...
70 - 75	LN-700, LN-750 Diesel con Eje de 9000 lb	C1TT-18045-C	010	83312	89409		...	...
		D2EF-18045-AA	010	83312	89409		...	...
91 - 97	LN-7000, LN-8000, LN-9000, LNT-8000, LNT-9000 con Muelles de 4500, 5400, 6000, 7200, 10000 lb y Ejes de 10000, 12000, 13200, 16000 lb	F1HT-18045-DB	010	83308	...		...	...
90	LN-7000, LN-8000, LN-9000, LNT-8000, LNT-9000 con Muelles Taperleaf de 52"	F1HT-18045-GA	010	85006	89401		...	...
91 - 97	LN-7000, LN-8000, LN-9000, LNT-8000, LNT-9000 con Muelles Taperleaf de 52"	F1HT-18045-GB	010	...	89403		...	...
90	LN-7000, LN-8000, LN-9000, LNT-8000, LNT-9000 con Muelles Taperleaf Parabólicas de 58"	F1HT-18045-RA	010	...	89402		...	...
90 - 97	LN-7000, LN-8000, LN-9000, LNT-8000, LNT-9000 con Muelles Taperleaf Parabólicas de 58"	F1HT-18045-RA	010	...	89402		...	...
		F1HT-18045-RB	010	...	89402		...	...
76 - 77	LN-800, LN-8000, LN-900, LN-9000, LNT-800, LNT-8000, LNT-900, LNT-9000	D2KF-18045-AA	010	83312	89409		...	...
76 - 81	LN-800, LN-8000, LN-900, LN-9000, LNT-800, LNT-8000, LNT-900, LNT-9000	D2HF-18045-AA	010	83314	...		...	...
		D7HT-18045-CA	010	83314	...		...	...
70 - 89	LN-800, LN-850, LN-8000, LN-900, LN-9000, LNT-800, LNT-850, LNT-880, LNT-8000, LNT-900, LNT-9000 con Ejes de 6000, 7000, 9000, 12000, 16000 lb	D2HF-18045-BA	010	83309	89446		...	...
		D7HT-18045-DA	010	83309	89446		...	...
70 - 71	LN-800, LN-850, LNT-900 con Ejes de 7000, 9000, 12000 lb	D2TF-18045-GA	010	83308	...		...	...
91 - 97	Modelos LN-7000, LN-8000, LN-9000, LNT-8000 o LNT-9000 Muelles Multihojas de 4000, 4500, 5400, 6000 o 7200 lb y Eje de 9000, 10000, 12000 o 16000 lb	F1HT-18045-CB	010	83216	...		...	...
90 - 97	Modelos LN-7000, LN-8000, LN-9000, LNT-8000 o LNT-9000 con Muelles Multihojas	F1HT-18045-DA	010	83312	89409		...	...
94 - 97	Modelos LN-7000, LN-8000, LN-9000, LNT-8000 o LNT-9000 con Muelles Taperleaf de 46" y 21000 o 23000 lb	F4HT-18080-BA		...	...	010	85001	89410
	Modelos LN-7000, LN-8000, LN-9000, LNT-8000 o LNT-9000 con Suspensión de Aire Trasera Hendrickson	47902-13		...	...	010	83122	89406
		F0HT-18080-AA		...	...	010	85005	89430
		F0HZ-18125-A		...	...	010	85005	89430









**N y NT 89" BBC Cabina Convencional**

64 - 69	N-1100 con Ejes desde 11000 a 15000 lb	C6PF-18077-DN	010	83314	...		...	...
64 - 69	N-500, N-550, N-600, N-650, N-700 con Ejes de 5000, 6000, 7000 & 9000 lb	D2TF-18045-GA	010	83308	...		...	...
64 - 69	N-500, N-550, N-600, N-650, N-700, N-750	C7PF-18077-A		...	...	010	83225	...
		D2TF-18080-HA		...	...	010	83225	...
64 - 67	N-600, N-650, N-700, N-750 con Eje de 6000 & 7000 lb	C6PF-18077-DL	010	83312	89409		...	...
67 - 69	N-750 con Eje de 9000 lb	C1TT-18045-C	010	83312	89409		...	...
64 - 69	N-800, N-850, N-900, N-950 - Exc. Diesel con Eje 6000 & 7000 lb	C1TT-18045-C	010	83312	89409		...	...
		C6PF-18077-DL	010	83312	89409		...	...
67 - 69	N-850, N-900, N-950 con Ejes de 6000, 7000, 9000, 11000, 12000 lb	C1TT-18045-C	010	83312	89409		...	...
67 - 69	N-850, N-900, N-950, N-1000, NT-850, NT-900, NT-950, NT-1000 con Ejes de 6000, 7000, 9000, 11000, 12000, 15000, 18000 lb	C1TT-18045-D	010	G63406	...		...	...

**Series AeroMax (A, AT, AAT, 8500, 9500)**

96	Modelos 8000 con Ejes de 12000 o 13000 lb	F6HT-18045-LA	010	85376	...		...	...
96	Modelos 8000 con Muelles Helicoidales 16000 lb.	F6HT-18045-AA	010	85054	89438		...	...

**GUÍA DE APLICACIONES – CAMIONES, TRÁILERS Y AUTOBUSES**

Año	Modelo	# E.O.	Delantero		Trasero	
						
						
			Fleetline	GasSLX	Fleetline	GasSLX

**FORD (Cont.)**

**Series AeroMax (A, AT, AAT, 8500, 9500) (Cont.)**

96 - 97	Modelos 9500 (113" & 122" BBC) con Eje de 10000 lb y Muelles de 54"	F6HT-18045-KA	010	83200	...		...	...
96 -	Modelos 9500 (113" & 122" BBC) con Eje de 12000 o 13200 lb y Muelles de 54"	F6HT-18045-BC	010	85047	89435		...	...
96 - 97	Modelos 9500 (113" y 122" BBC) con Eje de 8500 o 9000 lb y Muelles de 54"	F6HT-18045-HC	010	85054	89438		...	...
96 -	Todos con Eje 12000 lb, 13000 lb o 14600 lb, y Muelles de 60"	F6HT-18045-EB	010	85055	89439		...	...
		F6HT-18045-EC	010	85055	89439		...	...
		F6HZ-18124-D	010	85055	89439		...	...
		F6HZ-18124-E	010	85055	89439		...	...
96 -	Todos con Eje 13200 lb o 14600 lb, y Muelles de 54"	F6HT-18045-GB	010	85030	89440		...	...
		F6HT-18045-GC	010	85030	89440		...	...
96 -	Todos con Eje 21000 lb o 23000 lb y Muelles de 46"	F5HZ-18125-B		...	...	010	85001	89410
96 -	Todos con Eje 23000 lb y Muelles de 52"	F5HZ-18125-A		...	...	010	85314	89425
96 - 97	Todos con Eje Tandem Hendrickson 40LH	57241-2		...	...	01-	83109	...
		F6HT-18080-B		...	...	01-	83109	...
		F6HT-18080-DA		...	...	01-	83109	...
		F6HZ-18125-B		...	...	01-	83109	...
96 - 97	Todos con Suspensión de Aire Hendrickson HAS-400, HA-210 o HA-230	47902-28		...	...	010	85013	89414
		F6HZ-18080-FC		...	...	010	85013	89414
		F6HZ-18125-D		...	...	010	85013	89414
96 - 97	Todos con Suspensión de Aire Neway AD-123	90045068		...	...	-10	...	89441
		F6HZ-18125-C		...	...	-10	...	89441
96 - 97	Todos con Suspensión de Aire Neway AD-246	90045099		...	...	010	85906	89407
		90045132		...	...	010	85909	...
96 -	Todos los Modelos con Eje 10000 lb o 12000 lb y Muelles de 54"	F6HT-18045-AC	010	85054	89438		...	...
		F6HZ-18124-A	010	85054	89438		...	...
		F6HZ-18124-G	010	85054	89438		...	...





**Series B - Chasis Bus Cowl**

61 - 69	B - 500, B - 600, B - 700, B - 750 con Eje 4000, 4700 y 5000 lb	.....	-1-	83400	...		...	...
61 - 69	B - 500, B - 600, B - 700, B - 750 con Eje 6000 & 7000 lb	C2TA-18045-A	010	83216	...		...	...
77 - 96	B - 600, B - 700, B - 750, B - 800, B - 7000 con Eje 18500 lb	D7HT-18080-AA		...	...	010	83215	...
77 - 79	B - 600, B - 750, con Eje 18500 lb	D7HT-18080-DA		...	...	010	83215	...
94 - 97	B - 700, B - 800 con Muelles de 14600 lb	F4HT-18045-EA	010	83125	...		...	...
94 - 97	B - 700, B - 800 con Muelles de 15000, 17500, 19000 lb	F4HT-18080-AA		...	...	010	85314	89425
		F4HT-18080-AB		...	...	010	85314	89425
94 - 97	B - 700, B - 800 con Muelles de 21000 lb	F4HT-18080-BA		...	...	010	85001	89410
94 - 97	B - 700, B - 800 con Muelles de 52"	F4HT-18045-CB	010	83107	...		...	...
61 - 79	Modelos B - 500, B - 600, B - 700, B - 750	D2TF-18080-HA		...	...	010	83225	...
		D7HT-18080-BA		...	...	010	83225	...
70 - 79	Modelos B - 500, B - 600, B - 700, B - 750	D2TF-18045-GA	010	83308	...		...	...
		D7HT-18045-GA	010	83308	...		...	...
86 - 89	Modelos B - 600, B - 700 con Número de E.O.	ASH-24446		...	...	010	83215	...
		AX-310		...	...	010	83215	...
80 - 96	Modelos B - 600, B - 700, B - 800, B - 7000	D7HT-18080-DA		...	...	010	83215	...
		E0HT-18045-AA	010	83309	89446		...	...
		E0HT-18045-AB	010	83309	89446		...	...
		E0HT-18080-AA		...	...	010	83215	...
86 - 90	Modelos B - 600, B - 700, B - 800, B - 7000	F1HT-18045-AA	010	83309	89446		...	...
		E0HT-18080-AA		...	...	010	83215	...

**Series C & CT - Cabina Abatible**

71 - 73	C-500, C-550, C-600, C-650, C-700, C-750 con Eje 6000 & 7000 lb	D1TF-18045-LA	010	83312	89409		...	...
64 - 67	C-550, C-600 con Eje 6000 lb - Exc. Power Steering	C6PF-18077-A	010	G63306	...		...	...

**GUÍA DE APLICACIONES – CAMIONES, TRÁILERS Y AUTOBUSES**

Año	Modelo	# E.O.	Delantero		Trasero	
						
			Fleetline	GasSLX	Fleetline	GasSLX

**FORD (Cont.)**

**Series C & CT - Cabina Abatible (Cont.)**

64 - 67	C-550, C-600 con Eje 6000 lb y Power Steering	C2TA-18045-A	010	83216	...	...	...
80 - 90	C-600, C-700, C-7000, C-800, C-8000, CT-800, CT-8000 con Muelles de 3100 lb y Eje de 7000 lb	D7HT-18045-JA	010	83308	...	...	...
80 - 90	C-600, C-700, C-800, C-7000, CT-800, CT-8000 con Muelles de 4040, 5040 lb y Ejes de 7000, 9000, 12000 lb	D2EF-18045-AA	010	83312	89409	...	...
64 - 67	Modelos C-550, C-600, C-650, C-700, C-750	C6PF-18077-F		...	...	010	83225
67 - 69	Modelos C-600, C-650, C-700, C-750, C-800, C-850, C-1000 con Ejes 7000, 9000, 11000, 12000, 15000 lb - Exc. Base de Rueda de 175"	D2HF-18045-CA	010	83308	...	...	...
67 - 71	Modelos C-600, C-650, C-700, C-750, C-800, C-850, C-1000 con Ejes de 7000, 9000, 11000, 12000, 15000 lb - con Base de Rueda de 175"	C8HA-18045-A	010	83312	89409	...	...
76 - 79	Modelos C-600, C-700, C-750, C-800, C-900, CT-800, CT-900	D2EF-18045-AA	010	83312	89409	...	...
		D7KF-18045-EA	010	83312	89409	...	...
64 - 66	Modelos C700/1100, CT-700/1100 con Ejes de 7000, 9000, 11000 o 15000 lb	D2HF-18045-CA	010	83308	...	...	...
72 - 79	Modelos C-750, C-800, C-850, C-900, CT-750, CT-800, CT-850, CT-900 con Eje de 9000, 11000, 12000 o 15000 lb	D2KF-18045-AA	010	83312	89409	...	...
69 - 75	Modelos C-800, C-850, C-900, CT-800, CT-850, CT-900, CT-950 con Ejes de 9000 a 15000 lb	C8HA-18045-A	010	83312	89409	...	...
		D1TF-18045-LA	010	83312	89409	...	...

**Series CF Hechos en Brasil**

86 - 89	Modelos CF - 600, CF - 700	E5HT-18045-AA	010	85301	...	...	...
		E5HT-18080-DA		...	...	010	85315
		E5HT-18080-EA		...	...	010	85315
86 - 97	Modelos CF-7000, CF-8000 con Eje de 12000 lb o 13000 lb	.....		...	...	010	85302
		87HU-18045-AA	010	85301	...	...	89420
		E5HT-18045-AA	010	85301	...	...	...
		E6HZ-18124-A	010	85301	...	...	...
		E7HZ-18124-A	010	85301	...	...	...
92 - 97	Modelos CF-7000, CF-8000 o CFT-8000 con Eje de 9000 lb	F2HT-18045-BA	010	85376	...	...	...
		F2HT-18045-CA	010	85376	...	...	...
		F2HZ-18124-A	010	85376	...	...	...
		F6HT-18045-LA	010	85376	...	...	...
96 - 97	Modelos CF-7000, CF-8000 o CFT-8000 con Muelles Multihojas de 16000 lb	F6HT-18045-AA	010	85054	89438	...	...









**Series CL & CLT - Cabina Abatible para Tractor de Autopista**

78 - 89	CL-9000, CLT-9000 con Eje Trasero con Suspensión Neway	D7HA-18080-AA		...	...	010	83123	89405
78 - 89	CL-9000, CLT-9000 con Suspensión de Eje Trasero Sencillo	D4HA-18080-AA		...	...	010	83209	89414
78 - 89	Modelos CL-9000, CLT-9000	D7HT-18045-NA	010	85301	...	...	...	...
90 - 91	Modelos CL-9000, CLT-9000 con Muelles Multihojas	F1HT-18045-NA	010	85040	...	...	...	...
	Modelos con Suspensión de Aire Trasera Hendrickson	47902-13		...	...	010	83122	89406
	Modelos con Número de E.O.	D4HA-18080-AA		...	...	010	83209	89414

**Series F - Cabina Convencional**

64 - 69	F-500	C2TA-18045-A	010	83216	...	...	...
64 - 77	F-500	C7PF-18077-A		...	...	010	83225
		D2TF-18080-HA		...	...	010	83225
67 - 69	F-500	C8TA-18045-AA	-10	G63386	...	...	...
70 - 77	F-500	D2HT-18045-GA	010	83308	...	...	...
		D2TF-18045-GA	010	83308	...	...	...
64 - 79	F-600 (2 x 4), F-650, F-700, F-750	C7PF-18077-A		...	...	010	83225
		D2TF-18080-HA		...	...	010	83225
		D7HT-18080-BA		...	...	010	83225
71 - 79	F-600 (4 x 4)	D2HT-18045-GA	010	83308	...	...	...
		D2TF-18045-GA	010	83308	...	...	...
80 - 94	F-600, F-6000, F-700, F-7000, F-800, F-8000, FT-700, FT-800, FT-8000 - Exc. Eje de 9000 lb con Suspensión H.D. & Eje de 12000 lb	E0HT-18045-AA	010	83309	89446	...	...
		E0HT-18045-AB	010	83309	89446	...	...

## GUÍA DE APLICACIONES – CAMIONES, TRÁILERS Y AUTOBUSES



Año	Modelo	# E.O.	Delantero		Trasero	
						
						
			Fleetline	GasSLX	Fleetline	GasSLX

### FORD (Cont.)

#### Series F - Cabina Convencional (Cont.)

83 - 89	F-600, F-6000, F-700, F-7000, F-800, F-8000, FT-700, FT-800, FT-8000 con Eje de 9000 lb con Suspensión H.D. & Eje de 12000 lb	D2HF-18045-AA	010	83314	...	...	...
		D7HT-18045-CA	010	83314	...	...	...
67 - 69	F-600, F-650, F-700, F-750 con Ejes de 5500, 6000, 7000 & 9000 lb	C8TA-18045-AA	-10	G63386	...	...	...
70 - 79	F-600, F-650, F-700, F-750 con Ejes de 5500, 6000, 7000 & 9000 lb	D2HT-18045-GA	010	83308	...	...	...
		D2TF-18045-GA	010	83308	...	...	...
64 - 67	F-600, F-700, F-750	C7PF-18077-A		...	...	010	83225
64 - 69	F-600, F-700, F-750 con Eje de 6000 & 7000 lb	C2TA-18045-A	010	83216	...	...	...
86 - 90	F-600, F-700, F-800	ASH-24446		...	...	010	83215
		AX-310		...	...	010	83215
		E6HT-18080-AA		...	...	010	83215
		E6HZ-18125-D		...	...	010	83215
80 - 90	F-600, F-700, F-800 con Eje Trasero de 13000 & 15000 lb	D7HT-18080-BA		...	...	010	83225
80 - 90	F-600, F-700, F-800 con Eje Trasero de 17000 & 18000 lb	D7HF-18080-AA		...	...	010	83215
		D7HT-18080-DA		...	...	010	83215
89 - 94	F-600, F-700, LPO (Vehículo Perfil Bajo)	E9HS-18045-AA	010	83309	89446	...	...
		E9HS-18080-AA		...	...	010	85716
76 - 79	F-700	D2TF-18045-AA	010	83312	89409	...	...
71 - 72	F-700 (Diesel), F-750 con Eje de 9000 lb	D2HF-18045-CA	010	83308	...	...	...
73 - 79	F-700 (Diesel), F-750 con Eje de 9000 lb	D2EF-18045-AA	010	83312	89409	...	...
		D7HT-18045-BA	010	83312	89409	...	...
70	F-700 con Eje de 9000 lb	D2HF-18045-CA	010	83308	...	...	...
90 - 97	F-700, F-800	ASH-24446		...	...	010	83215
		AX-310		...	...	010	83215
		E6HT-18080-AA		...	...	010	83215
		E6HZ-18125-D		...	...	010	83215
94 - 98	F-700, F-800 con Muelles de 15000, 17500, 19000 lb	F4HT-18080-AA		...	...	010	85314
		F4HT-18080-AB		...	...	010	85314
		F5HZ-18125-A		...	...	010	85314
94 - 97	F-700, F-800 con Muelles de 21000 lb	F4HT-18080-BA		...	...	010	85001
95 - 97	F-700, F-800 con Muelles de 52" o 54" y Eje de 10000 o 12000 lb	F5HZ-18124-C	010	85063	...	...	...
94 - 97	F-700, F-800 con Muelles Multihojas y Eje de 10000, 12000 o 13200 lb	F4HT-18045-CB	010	83107	...	...	...
		F5HZ-18124-B	010	83107	...	...	...
94 - 97	F-700, F-800 con Muelles Multihojas y Eje de 14600 lb	F4HT-18045-EA	010	83125	...	...	...
		F5HZ-18124-D	010	83125	...	...	...
94 - 98	F-700, F-800 con Muelles Taperleaf y Eje de 6000, 7000, 8500, 9000 lb	F4HT-18045-AB	010	83314	...	...	...
		F4HT-18045-AC	010	83314	...	...	...
		F5HZ-18124-A	010	83314	...	...	...
94 - 97	F-700, F-800 con Muelles y Eje de 10000 o 12000 lb	F4HT-18045-DA	010	85063	...	...	...
76 - 79	F-800	D2HT-18080-HA		...	...	010	83225
		D2TF-18045-AA	010	83312	89409	...	...
		D2TF-18045-GA	010	83308	...	...	...
		D7HT-18045-GA	010	83308	...	...	...
		D7HT-18080-BA		...	...	010	83225
78 - 79	F-800 con Eje de 9000 lb	D2EF-18045-AA	010	83312	89409	...	...
		D7HT-18045-BA	010	83312	89409	...	...
64 - 66	F-800, F-850, F-900, F-950, F-1000 - Exc. Diesel con Eje CP de 11000 lb	C1TT-18045-D	010	G63406	...	...	...
64 - 69	F-800, F-850, F-900, F-950, F-1000 con Ejes de 6000, 7000, 9000, 11000, 12000, 15000, 18000 lb (Exc. Diesel con Ejes de 6000 y 7000 lb)	C1TT-18045-C	010	83312	89409	...	...
		C6PF-18077-DL	010	83312	89409	...	...

**GUÍA DE APLICACIONES – CAMIONES, TRÁILERS Y AUTOBUSES**

Año	Modelo	# E.O.	Delantero		Trasero	
						
			Fleetline	GasSLX	Fleetline	GasSLX

**FORD (Cont.)**

**Series F - Cabina Convencional (Cont.)**





64 - 69	F-950, F-1000, F-1100 Diesel con Eje de 7000 lb	C6PF-18077-DN	010	83314	...	...	...
64 - 66	Modelos F-1000 con Ejes de 11000 lb a 15000 lb	C1TT-18045-D	010	G63406	...	...	...
90	Modelos F-600, F-700, F-800, FT-800, FT-900 con Muelles Multihojas	F1HT-18045-AA	010	83309	89446	...	...

**Series F - Modelos F450, F550, F650, F750**

99 - 04	F-450 , F-550 Superduty con rodada trasera sencilla o doble - base de rueda de 165" o 201"	ASH-23486		...	...	010	G63461	...
		ASH-247		...	...	010	G63461	...
		AT-610		...	...	010	G63461	...
		AT-611		...	...	010	G63461	...
		F81A-18080-DCA		...	...	010	G63461	...
		F81Z-18125-DC		...	...	010	G63461	...
05 - 10	F-650 con Muelles Traseras de 22,000 lb	4C4Z-18125-B		...	...	-10	83317	...
		501906C92		...	...	-10	83317	...
00 - 03	F-650 con Muelles Traseras de 23,000 lb	AT-696		...	...	010	83140	...
		F81A-18080-ZC		...	...	010	83140	...
		F81Z-18125-ZA		...	...	010	83140	...
00 - 13	F-650 con Número de E.O.	3584118C2	010	85928	...		...	...
		4C4Z-18124-RA	010	85928	...		...	...
		AA-617	010	85928	...		...	...
05 - 07	F-650 con Número de E.O.	3553628C1	010	85927	...		...	...
		3553628C2	010	85927	...		...	...
00 - 03	F-750 con Muelles Traseras de 23000 lb	AT-696		...	...	010	83140	...
		F81A-18080-ZC		...	...	010	83140	...
		F81Z-18125-ZA		...	...	010	83140	...
00 - 13	F-750 con Número de E.O.	3584118C2	010	85928	...		...	...
		4C4Z-18124-RA	010	85928	...		...	...
		AA-617	010	85928	...		...	...
05 - 07	F-750 con Número de E.O.	3553628C1	010	85927	...		...	...
		3553628C2	010	85927	...		...	...
05 - 10	F-750 con Suspensión Trasera de Muelles de 22,000 lb	4C4Z-18125-B		...	...	-10	83317	...
		501906C92		...	...	-10	83317	...
98 - 03	Modelos F-650 con Eje Delantero de 8500 lb o 9000 lb	AA-494	010	83131	...		...	...
		XC35-18045-AB	010	83131	...		...	...
		XC35-18045-AD	010	83131	...		...	...
		XC35-18045-JA	010	83131	...		...	...
		XC3Z-18124-JA	010	83131	...		...	...
- 15	Modelos F-650 con Suspensión de Aire Trasera de 21000 lb	3578858C1		...	...	010	85926	...
		3578858C2		...	...	010	85926	...
		4C4Z-18125-DA		...	...	010	85926	...
00 - 13	Modelos F-650 con Suspensión Delantera de 10,000 lb	3584116C1	010	83175	...		...	...
		3584116C2	010	83175	...		...	...
		4C4Z-18124-QA	010	83175	...		...	...
		AA-616	010	83175	...		...	...
00 - 15	Modelos F-650 con Suspensión Delantera de 6,000 a 8,000 lb	3584117C2	010	83135	...		...	...
		4C4Z-18124-HB	010	83135	...		...	...
		4C4Z-18124-P	010	83135	...		...	...
		AA-615	010	83135	...		...	...
		AT-811	010	83135	...		...	...
		FC4Z-18124-HB	010	83135	...		...	...
98 - 03	Modelos F-750 con Eje Delantero de 8500 lb o 9000 lb	AA-494	010	83131	...		...	...
		XC35-18045-AB	010	83131	...		...	...
		XC35-18045-AD	010	83131	...		...	...
		XC35-18045-JA	010	83131	...		...	...
		XC3Z-18124-JA	010	83131	...		...	...



## GUÍA DE APLICACIONES – CAMIONES, TRÁILERS Y AUTOBUSES

Año	Modelo	# E.O.	Delantero		Trasero	
			 Fleetline	 GasSLX	 Fleetline	 GasSLX

### FORD (Cont.)

#### Series F - Modelos F450, F550, F650, F750 (Cont.)

- 15	Modelos F-750 con Suspensión de Aire Trasera de 21000 lb	3578858C1		...	...	OIO	<b>85926</b>	...
		3578858C2		...	...	OIO	<b>85926</b>	...
		4C4Z-18125-DA		...	...	OIO	<b>85926</b>	...
00 - 13	Modelos F-750 con Suspensión Delantera de 10,000 lb	3584116C1	OIO	<b>83175</b>	...		...	...
		3584116C2	OIO	<b>83175</b>	...		...	...
		4C4Z-18124-QA	OIO	<b>83175</b>	...		...	...
		AA-616	OIO	<b>83175</b>	...		...	...
00 - 15	Modelos F-750 con Suspensión Delantera de 6,000 a 8,000 lb	3584117C2	OIO	<b>83135</b>	...		...	...
		4C4Z-18124-HB	OIO	<b>83135</b>	...		...	...
		4C4Z-18124-P	OIO	<b>83135</b>	...		...	...
		AA-615	OIO	<b>83135</b>	...		...	...
		AT-811	OIO	<b>83135</b>	...		...	...
		FC4Z-18124-HB	OIO	<b>83135</b>	...		...	...

#### Series FT - Cabina Convencional

90 - 92	FT-900 (Perfil Bajo)	E9HS-18080-AA		...	...	OIO	<b>85716</b>	...
90 - 94	FT-900 (Perfil Bajo)	E9HS-18045-AA	OIO	<b>83309</b>	<b>89446</b>		...	...
		E9HZ-18124-A	OIO	<b>83309</b>	<b>89446</b>		...	...
90 - 97	FT-900 con amortiguador adelante del eje trasero	ASH-24446		...	...	OIO	<b>83215</b>	...
		AX-310		...	...	OIO	<b>83215</b>	...
		E6HT-18080-AA		...	...	OIO	<b>83215</b>	...
		E6HZ-18125-D		...	...	OIO	<b>83215</b>	...
90 - 94	FT-900 con Eje de 9000 lb y Suspensión H.D. o Ejes de 10000, 11000, o 12000 lb	C4HZ-18124-E	OIO	<b>83309</b>	<b>89446</b>		...	...
		E9HS-18045-AA	OIO	<b>83309</b>	<b>89446</b>		...	...
		F1HT-18045-AA	OIO	<b>83309</b>	<b>89446</b>		...	...
		F1HZ-18124-A	OIO	<b>83309</b>	<b>89446</b>		...	...
94 - 97	FT-900 con Muelles Multihojas y Eje de 10000, 12000 o 13200 lb	F4HT-18045-CB	OIO	<b>83107</b>	...		...	...
		F5HZ-18124-B	OIO	<b>83107</b>	...		...	...
94 - 97	FT-900 con Muelles Multihojas y Eje de 14600 lb	F4HT-18045-EA	OIO	<b>83125</b>	...		...	...
		F5HZ-18124-D	OIO	<b>83125</b>	...		...	...
95 - 97	FT-900 con Muelles Taperleaf 52 o 54" y Eje de 10000 o 12000 lb	F5HZ-18124-C	OIO	<b>85063</b>	...		...	...
94 - 97	FT-900 con Muelles Taperleaf de 46" y Eje 15000, 17500 o 19000 lb	F4HT-18080-AA		...	...	OIO	<b>85314</b>	<b>89425</b>
		F4HT-18080-AB		...	...	OIO	<b>85314</b>	<b>89425</b>
		F5HZ-18125-DA		...	...	OIO	<b>85314</b>	<b>89425</b>
94 - 97	FT-900 con Muelles Taperleaf de 46" y Eje de 21000 lb	F4HT-18080-BA		...	...	OIO	<b>85001</b>	<b>89410</b>
94 - 97	FT-900 con Muelles Taperleaf y Eje de 10000 o 12000 lb	F4HT-18045-DA	OIO	<b>85063</b>	...		...	...
94 - 97	FT-900 con Muelles Taperleaf y Ejes de 6000, 7000, 8500 o 9000 lb	F4HT-18045-AB	OIO	<b>83314</b>	...		...	...
		F5HZ-18124-A	OIO	<b>83314</b>	...		...	...



#### Series H y HT - Cabina Abatible Alta

61 - 63	HT-950 con Eje de 11000 lb	.....	OIO	<b>83314</b>	...		...	...
61 - 66	HT-950 con Eje de 12000 & 15000 lb	.....	OIO	<b>83314</b>	...		...	...

#### Series Louisville - Cabina Convencional

96 - 97	Todos con Eje 12000 lb, 13000 lb o 14600 lb, y Muelles de 60"	F6HT-18045-EB	OIO	<b>85055</b>	<b>89439</b>		...	...
		F6HT-18045-EC	OIO	<b>85055</b>	<b>89439</b>		...	...
		F6HZ-18124-D	OIO	<b>85055</b>	<b>89439</b>		...	...
		F6HZ-18124-E	OIO	<b>85055</b>	<b>89439</b>		...	...
		F6HZ-18124-F	OIO	<b>85055</b>	<b>89439</b>		...	...
96 -	Todos con Eje 13200 lb o 14600 lb, y Muelles de 54"	F6HT-18045-GB	OIO	<b>85030</b>	<b>89440</b>		...	...
		F6HT-18045-GC	OIO	<b>85030</b>	<b>89440</b>		...	...
96 - 97	Todos con Eje 8500 lb o 9000 lb con Muelles de 54"	F6HT-18045-HB	OIO	<b>85054</b>	<b>89438</b>		...	...
		F6HT-18045-HC	OIO	<b>85054</b>	<b>89438</b>		...	...
		F6HZ-18124-H	OIO	<b>85054</b>	<b>89438</b>		...	...

**GUÍA DE APLICACIONES – CAMIONES, TRÁILERS Y AUTOBUSES**

Año	Modelo	# E.O.	Delantero		Trasero	
						
			Fleetline	GasSLX	Fleetline	GasSLX

**FORD (Cont.)**

**Series Louisville - Cabina Convencional (Cont.)**

	Todos con Muelles de 54" y con Eje 12000 o 13200 lb	F6HT-18045-BC	010	<b>85047</b>	89435		...	...
96 -	Todos con Muelles de 54" y con Eje 14600 o 16000 lb	F6HT-18045-CC	010	<b>85055</b>	89439		...	...
		F6HZ-18124-C	010	<b>85055</b>	89439		...	...
96 - 97	Todos con Muelles de 54" y con Eje 8500 o 9000 lb	F6HT-18045-JB	010	<b>83200</b>	...		...	...
		F6HT-18045-JC	010	<b>83200</b>	...		...	...
		F6HZ-18124-J	010	<b>83200</b>	...		...	...
	Todos con Suspensión de Aire Hendrickson HAS-400	47902-28		...	...	010	<b>85013</b>	89414
		F6HZ-18080-FC		...	...	010	<b>85013</b>	89414
		F6HZ-18125-D		...	...	010	<b>85013</b>	89414
	Todos con Suspensión de Aire Neway AD-123	90045068		...	...	-10	...	89441
		F6HZ-18125-C		...	...	-10	...	89441
	Todos con Suspensión de Aire Neway AD-246	90045099		...	...	010	<b>85906</b>	89407
		90045132		...	...	010	<b>85909</b>	...
96 - 97	Todos los Modelos con Eje 10000 lb o 12000 lb y Muelles de 54"	F6HT-18045-AC	010	<b>85054</b>	89438		...	...
		F6HZ-18124-A	010	<b>85054</b>	89438		...	...
		F6HZ-18124-G	010	<b>85054</b>	89438		...	...

**Series P - Mensajería**

57 - 76	P-400 & 4000 con Muelles H.D.	....	010	<b>85012</b>	89413		...	...
57 - 76	P500, P-5000	....	010	<b>85012</b>	89413	010	<b>83225</b>	...
78 - 79	P-600	D7HT-18045-HA	010	<b>85012</b>	89413		...	...
		D7HT-18080-CA		...	...	010	<b>83225</b>	...

**Series T - Tandem Convencional**

64 - 69	T-750, T-800, T-850, T-900, T-950 con Ejes de 6000, 7000, 9000, 11000, 12000, 15000, 18000 lb	C1TT-18045-D	010	<b>G63406</b>	...		...	...
64 - 69	T-750, T-800, T-850, T-900, T-950 con Ejes desde 9000 hasta 15000 lb	C1TT-18045-E	010	<b>83314</b>	...		...	...
		C6PF-18077-DN	010	<b>83314</b>	...		...	...





**Series W y WT - Cabina Abatible para Tractor de Autopista**

66 - 71	W-900, W-950, W-1000, WT-900, WT-950, WT-1000 con Eje de 11000 lb	D2HA-18045-E1A	010	<b>85304</b>	...		...	...
		D2HA-18045-E1B	010	<b>85304</b>	...		...	...
		D2HA-18045-E2A	010	<b>85304</b>	...		...	...
		D2HA-18045-E2B	010	<b>85304</b>	...		...	...
66 - 77	W-900, W-950, W-1000, WT-900, WT-950, WT-1000 con Eje de 12000 & 15000 lb	C6TA-18045-Y	010	<b>85301</b>	...		...	...
		C6TA-18045-Z	010	<b>85301</b>	...		...	...
		C6TA-18045-Z	010	<b>85301</b>	...		...	...
73 - 77	W-900, WT-900 con Suspensión de Aire	D2HZ-18080-A		...	...	010	<b>83209</b>	89414
		D4HA-18080-AA		...	...	010	<b>83209</b>	89414

**Intercambios Adicionales de E.O.**

	HN-80 con Eje de 21000 lb o 23000 lb & Suspensión Trasera de Muelles Taperleaf de 52"	F6HT-18080-JA		...	...	010	<b>85305</b>	...
	Modelos con Número de E.O.	0017LA-18080-G		...	...	-10	<b>83161</b>	...
		3U2Z-18124-BAA	010	<b>G63809</b>	...		...	...
		3U2Z-18124-EA	-10	<b>G63772</b>	...		...	...
		3U2Z-18124-FA	-10	<b>G63608</b>	...		...	...
		3U2Z-18124-YAA	010	<b>G63809</b>	...		...	...
		3U2Z-18125-CA		...	...	010	<b>G63607</b>	...
		3U2Z-18125-DA		...	...	010	<b>G63525</b>	...
		3U2Z-18125-EA		...	...	010	<b>G63524</b>	...
		3U2Z-18125-RA		...	...	-10	<b>G63623</b>	...
		47902-8		...	...	010	<b>83122</b>	89406
		4U2Z-18V124-AA	-10	<b>G63678</b>	...		...	...
		57365-111	010	<b>85006</b>	<b>89401</b>		...	...
		5C3Z-18124-JA	-10	<b>G63969</b>	...		...	...

**GUÍA DE APLICACIONES – CAMIONES, TRÁILERS Y AUTOBUSES**





Año	Modelo	# E.O.	Delantero		Trasero	
						
			Fleetline	GasSLX	Fleetline	GasSLX

**FORD (Cont.)**

**Intercambios Adicionales de E.O. (Cont.)**

Modelos con Número de E.O.						
5C3Z-18125-CF	...	...	010	<b>77969</b>	...	
5C3Z-18125-DA	...	...	010	<b>77968</b>	...	
5U2Z-18V124-AA	-10	<b>G63714</b>	...	...	...	
5U2Z-18V124-AHA	01-	<b>G63622</b>	...	...	...	
5U2Z-18V124-AU	-10	<b>G63772</b>	...	...	...	
5U2Z-18V124-BA	-10	<b>G63716</b>	...	...	...	
5U2Z-18V124-CAA	010	<b>G63809</b>	...	...	...	
5U2Z-18V124-DB	010	<b>G63455</b>	...	...	...	
5U2Z-18V124-LA	-10	<b>G63929</b>	...	...	...	
5U2Z-18V125-AE		...	...	010	<b>G63808</b>	...
5U2Z-18V125-AF		...	...	010	<b>G63810</b>	...
5U2Z-18V125-BDA		...	...	-10	<b>G63623</b>	...
5U2Z-18V125-BGA		...	...	-10	<b>G63778</b>	...
5U2Z-18V125-BS		...	...	010	<b>G63607</b>	...
5U2Z-18V125-BT		...	...	010	<b>G63525</b>	...
5U2Z-18V125-BU		...	...	010	<b>G63524</b>	...
5U2Z-18V125-F		...	...	010	<b>G63676</b>	...
5U2Z-18V125-G		...	...	010	<b>G63837</b>	...
5U2Z-18V125-H		...	...	010	<b>G63406</b>	...
6C2Z-18124-B	-10	<b>G63929</b>	...	...	...	
6ETZ-18124-AA	010	<b>83145</b>	...	...	...	
6ETZ-18125-A		...	...	010	<b>83146</b>	...
70127	010	<b>85006</b>	<b>89401</b>	...	...	
70128	010	<b>85006</b>	<b>89401</b>	...	...	
7C34-18045-HB	-10	<b>G63969</b>	...	...	...	
7C34-18080-DCB		...	...	010	<b>77968</b>	...
90044769		...	...	010	<b>83207</b>	<b>89407</b>
90044770		...	...	010	<b>83207</b>	<b>89407</b>
AX-267A	010	<b>83309</b>	<b>89446</b>	...	...	
B3Q-18124-A	010	<b>83219</b>	...	...	...	
B3Q-18125-A		...	...	010	<b>83217</b>	...
B3TZ-18125-A		...	...	010	<b>83217</b>	...
B6TZ-18124-A	010	<b>83219</b>	...	...	...	
B6TZ-18125-B		...	...	-10	<b>83161</b>	...
B6TZ-18125-C		...	...	-10	<b>83161</b>	...
B6TZ-18125-E		...	...	-10	<b>83161</b>	...
B7C-18125-A		...	...	010	<b>83217</b>	...
B7T-18124-C	010	<b>83225</b>	...	...	...	
B7TZ-18124-B	010	<b>83216</b>	...	...	...	
B7TZ-18124-C	010	<b>83216</b>	...	...	...	
B7TZ-18124-D	010	<b>83219</b>	...	...	...	
B7TZ-18124-E	010	<b>83217</b>	...	...	...	
B7TZ-18125-C		...	...	010	<b>83217</b>	...
B8Q-18125-A		...	...	010	<b>85307</b>	...
B8QZ-18124-A	010	<b>83312</b>	<b>89409</b>	...	...	
B8TZ-18124-A	010	<b>83219</b>	...	...	...	
B9TT-18045-C	010	<b>83219</b>	...	...	...	
B9TT-18045-D	010	<b>83219</b>	...	...	...	
B9TT-18080-B		...	...	-10	<b>83161</b>	...
B9TZ-18125-B		...	...	-10	<b>83161</b>	...
C0TT-18045-A	010	<b>83219</b>	...	...	...	
C0TT-18045-D	010	<b>83216</b>	...	...	...	
C0TZ-18124-A	010	<b>83216</b>	...	...	...	
C1TT-18045-G	010	<b>83216</b>	...	...	...	
C1TT-18080-B		...	...	010	<b>83217</b>	...

GUÍA DE APLICACIONES – CAMIONES, TRÁILERS Y AUTOBUSES





Año	Modelo	# E.O.	Delantero		Trasero	
			 Fleetline	 GasSLX	 Fleetline	 GasSLX

FORD (Cont.)

Intercambios Adicionales de E.O. (Cont.)

Modelos con Número de E.O.						
C1TZ-18045-C	010	83312	89409		...	...
C1TZ-18124-A	010	83217	...		...	...
C1TZ-18124-B	010	83216	...		...	...
C1TZ-18124-C	010	83312	89409		...	...
C1TZ-18124-D	010	83309	89446		...	...
C1TZ-18124-E	010	83312	89409		...	...
C1TZ-18124-F	010	83312	89409		...	...
C1TZ-18124-N	010	83314	...		...	...
C1TZ-18124-P	010	83312	89409		...	...
C1TZ-18125-B		...	...	010	83217	...
C1VT-18080-B		...	...	010	83217	...
C2TA-18045-B	010	83308	...		...	...
C2TZ-18124-A	010	83308	...		...	...
C3TA-18045-A	010	83216	...		...	...
C3TZ-18124-A	010	83308	...		...	...
C4HZ-18124-A	010	83312	89409		...	...
C4HZ-18124-B	010	83309	89446		...	...
C4HZ-18124-C	010	83314	...		...	...
C4HZ-18124-D	010	83312	89409		...	...
C4HZ-18124-F	010	83308	...		...	...
C4PF-18045-H	010	83216	...		...	...
C4TZ-18124-AA	010	83308	...		...	...
C4TZ-18124-AB	010	83308	...		...	...
C4TZ-18124-B	010	83308	...		...	...
C5TZ-18124-A	010	83308	...		...	...
C6PF-18077-AC		...	...	-10	83161	...
C6TA-18045-U	010	85301	...		...	...
C6TA-18045-V	010	85301	...		...	...
C6TS-18080-A		...	...	010	83217	...
C6TZ-18124-D	010	85301	...		...	...
C6TZ-18124-E	010	85301	...		...	...
C6TZ-18124-H	010	85301	...		...	...
C6TZ-18124-J	010	85301	...		...	...
C7HZ-18124-A	010	83312	89409		...	...
C7TA-18045-R	010	83216	...		...	...
C7TA-18045-Z	010	85301	...		...	...
C8PF-18045-CM	010	83216	...		...	...
C8PF-18045-S	-10	83161	...		...	...
C8PF-18045-T	-10	83161	...		...	...
C8TA-18080-Y		...	...	-10	83161	...
C8TA-18080-Z		...	...	-10	83161	...
C8TZ-18125-D		...	...	-10	83161	...
D0HA-18045-D	010	83309	89446		...	...
D0HZ-18124-A	010	83309	89446		...	...
D0HZ-18124-B	010	83312	89409		...	...
D0HZ-18124-C	010	83314	...		...	...
D1TZ-18124-D	010	83308	...		...	...
D1TZ-18124-E	010	83216	...		...	...
D1TZ-18124-F	010	83312	89409		...	...
D1TZ-18125-E		...	...	010	83217	...
D2EF-18124-AA	010	83312	89409		...	...
D2HA-18045-EB	010	85301	...		...	...
D2HA-18045-F1A	010	85301	...		...	...
D2HA-18045-F1B	010	85301	...		...	...
D2HA-18045-F2A	010	85301	...		...	...

## GUÍA DE APLICACIONES – CAMIONES, TRÁILERS Y AUTOBUSES





Año	Modelo	# E.O.	Delantero		Trasero	
						
			Fleetline	GasSLX	Fleetline	GasSLX

### FORD (Cont.)

#### Intercambios Adicionales de E.O. (Cont.)

	Modelos con Número de E.O.					
	D2HA-18045-F2B	010	85301	...		...
	D2HF-18045-A	010	83314	...		...
	D2HF-18124-AA	010	83314	...		...
	D2HT-18045-EA	010	83312	89409		...
	D2HZ-18080-A		...	...	010	83209 89414
	D2HZ-18125-A		...	...	010	83209 89414
	D2HZ-18125-B		...	...	010	83209 89414
	D2KF-18124-AA	010	83312	89409		...
	D2TA-18045-AAA	010	83219	...		...
	D2TA-18045-ZA	010	83219	...		...
	D2TF-18045-FA	010	83312	89409		...
	D2TF-18080-NA		...	...	010	83217
	D2TF-18124-F	010	83309	89446		...
	D2TZ-18124-A	010	83308	...		...
	D2TZ-18124-E	010	83312	89409		...
	D2TZ-18124-F	010	83309	89446		...
	D2TZ-18124-G	010	83314	...		...
	D2TZ-18124-H	010	83308	...		...
	D2TZ-18124-J	010	83312	89409		...
	D3TA-18045-BA	010	83219	...		...
	D3TZ-18124-B	010	83219	...		...
	D3TZ-18125-C		...	...	010	83217
	D3TZ-18125-D		...	...	010	83217
	D4HA-18080-A		...	...	010	83209 89414
	D4TF-18045-AA	010	83312	89409		...
	D4TZ-18124-J	010	83308	...		...
	D5TZ-18124-B	010	83308	...		...
	D5TZ-18124-C	010	83312	89409		...
	D7HF-18125-AA		...	...	010	83215
	D7HT-18124-BA	010	83312	89409		...
	D7HT-18124-CA	010	83314	...		...
	D7HT-18124-DA	010	83309	89446		...
	D7HT-18124-EA	010	83312	89409		...
	D7HT-18124-FA	010	83312	89409		...
	D7HT-18124-GA	010	83308	...		...
	D7HT-18124-HA	010	83219	...		...
	D7HT-18124-JA	010	83308	...		...
	D7HT-18124-KA	010	85301	...		...
	D7HT-18125-BA		...	...	010	83217
	D7HT-18125-CA		...	...	010	83217
	D7HT-18125-DA		...	...	010	83215
	D7HT-18125-FA		...	...	010	83123 89405
	D7HZ-18125-A		...	...	010	83215
	D7TA-18124-GA	010	83314	...		...
	D7TZ-18125-C		...	...	010	83217
	D8HZ-18124-A	010	85301	...		...
	D8HZ-18125-A		...	...	010	83209 89414
	D8HZ-18125-B		...	...	010	83123 89405
	E0HZ-18124-A	010	83309	89446		...
	E1TA-18045-AA	010	83309	89446		...
	E1TD-18045-AA	010	83309	89446		...
	E5HT-18045-AA	010	85301	...		...
	E5HT-18045-DA	010	85301	...		...
	E5HT-18045-EA	010	85301	...		...
	E5HT-18080-DA		...	...	010	85315

GUÍA DE APLICACIONES – CAMIONES, TRÁILERS Y AUTOBUSES





Año	Modelo	# E.O.	Delantero		Trasero	
			 Fleetline	 GasSLX	 Fleetline	 GasSLX

FORD (Cont.)

Intercambios Adicionales de E.O. (Cont.)

Modelos con Número de E.O.						
E6HZ-18124-D	010	85301	...		...	...
E6HZ-18125-E		...	...	010	85315	...
E6HZ-18125-F		...	...	010	85315	...
E7XZ-18124-A	-10	G63386	...		...	...
E7XZ-18124-B	-10	G63500	...		...	...
E7XZ-18124-C	-10	G63511	...		...	...
E7XZ-18124-D	-10	G63396	...		...	...
E7XZ-18124-F	-1-	G63398	...		...	...
E7XZ-18124-G	-1-	G63398	...		...	...
E7XZ-18125-A		...	...	-10	G63350	...
E7XZ-18125-B		...	...	-10	G63387	...
E7XZ-18125-C		...	...	010	G63409	...
E7XZ-18125-D		...	...	010	G63406	...
E7XZ-18125-E		...	...	010	G63406	...
E7XZ-18125-G		...	...	010	G63811	...
E7XZ-18125-J		...	...	010	G63299	...
E9HZ-18125-A		...	...	010	85716	...
E9HZ-18125-AA		...	...	010	85716	...
F0HS-18045-AA	010	85006	89401		...	...
F0HT-18045-AA	010	85006	89401		...	...
F0HZ-18124-A	010	85006	89401		...	...
F0HZ-18124-B	010	85006	...		...	...
F1HT-18045-KB	010	85006	89401		...	...
F1HT-18045-LB	010	85006	89401		...	...
F1HT-18045-RB	010	...	89402		...	...
F1HZ-18124-AA	010	83309	89446		...	...
F1HZ-18124-B	010	83308	...		...	...
F1HZ-18124-C	010	...	89402		...	...
F1HZ-18124-D	010	85006	89401		...	...
F1HZ-18124-E	010	85006	89401		...	...
F1HZ-18124-F	010	85006	89401		...	...
F1HZ-18124-G	010	85006	89401		...	...
F1HZ-18124-H	010	85040	...		...	...
F1HZ-18124-J	010	83308	...		...	...
F1HZ-18124-K	010	...	89402		...	...
F2HT-18045-DA	010	85006	89401		...	...
F2HT-18080-DA		...	...	010	85712	...
F2HZ-18124-B	010	85301	...		...	...
F2HZ-18124-C	010	85006	89401		...	...
F2HZ-18125-A		...	...	010	85712	...
F4TA-18045-TA	010	G63455	...		...	...
F4TA-18080-PA		...	...	010	G63461	...
F4TZ-18124-D	-10	G63414	...		...	...
F4TZ-18124-K	010	G63455	...		...	...
F4TZ-18125-E		...	...	010	G63461	...
F4TZ-18125-L		...	...	010	G63406	...
F57Z-18125-BB		...	...	010	G63679	...
F5HZ-18124-AA	010	83314	...		...	...
F5HZ-18124-C	010	85063	...		...	...
F5HZ-18124-DA	010	83125	...		...	...
F5HZ-18125-A		...	...	010	85314	89425
F5HZ-18125-AA		...	...	010	85314	89425
F5HZ-18125-B		...	...	010	85001	89410
F5HZ-18125-BA		...	...	010	85001	89410
F5TZ-18124-B	-10	G63608	...		...	...

**GUÍA DE APLICACIONES – CAMIONES, TRÁILERS Y AUTOBUSES**









Año	Modelo	# E.O.	Delantero		Trasero	
						
			Fleetline	GasSLX	Fleetline	GasSLX

**FORD (Cont.)**

**Intercambios Adicionales de E.O. (Cont.)**

Modelos con Número de E.O.	F5TZ-18125-BC		...	...	010	G63607	...
	F5UZ-18124-A	01-	G63622	...		...	...
	F5UZ-18124-B	01-	G63622	...		...	...
	F5UZ-18125-A		...	...	-10	G63623	...
	F5UZ-18125-C		...	...	-10	G63624	...
	F6HT-18045-KA	010	83200	...		...	...
	F6HT-18045-MA	010	85006	89401		...	...
	F6HT-18080-CA		...	...	010	85314	89425
	F6HT-18080-EA		...	...	010	85906	89407
	F6HT-18080-FC		...	...	010	85013	89414
	F6HZ-18124-B	010	83308	...		...	...
	F6HZ-18124-J	010	83200	...		...	...
	F6HZ-18124-KA	010	83200	...		...	...
	F6HZ-18124-MA	010	85006	89401		...	...
	F6HZ-18125-A		...	...	010	85314	89425
	F6HZ-18125-D		...	...	010	85013	89414
	F6HZ-18125-JA		...	...	010	85305	...
	F7C2Z-18124-BR	-10	G63929	...		...	...
	F7TA-18045-AA	-10	G63608	...		...	...
	F7TA-18080-BA		...	...	010	G63607	...
	F81Z-18124-AL	01-	G63622	...		...	...
	F81Z-18124-BK	010	G63809	...		...	...
	F87Z-18125-CA		...	...	010	G63773	...
	F87Z-18125-RA		...	...	010	G63775	...
	LA-18080		...	...	-10	83161	...
	LA-18080-A		...	...	-10	83161	...
	LA-18080-B		...	...	-10	83161	...
	LA-18080-C		...	...	-10	83161	...
	LA-18080-F		...	...	-10	83161	...
	LA-18080-J		...	...	-10	83161	...
	TAAH-18080-A		...	...	-10	83161	...
	TAAH-18080-A2		...	...	-10	83161	...
	TAAH-18080-A3		...	...	-10	83161	...
	TAAK-18080-A		...	...	-10	83161	...
	TAAK-18080-A1		...	...	-10	83161	...
	TAAK-18080-A2		...	...	-10	83161	...
	TACAA-18045-A	010	83216	...		...	...
	TANNA-18045-A	010	83312	89409		...	...
	TBAK-18080-A		...	...	-10	83161	...
	TBDA-18080-A		...	...	010	83217	...
	TBDA-18080-B		...	...	010	83217	...
	TDAA-18080-A		...	...	-10	83161	...
	TDAA-18080-B		...	...	010	83217	...
	TDBA-18045-A	010	83219	...		...	...
	TDBA-18045-B	010	83219	...		...	...
	TDBA-18080-A		...	...	010	83217	...
	TDBA-18080-B		...	...	010	83217	...
	TDBA-18080-C		...	...	010	83217	...
	TDBE-18045-A	010	83219	...		...	...
	TFAA-18045-B	010	83219	...		...	...
	TFAA-18045-C	010	83219	...		...	...
	TFAA-18080-A		...	...	010	85307	...
	THAB-18045-A	010	83219	...		...	...
	THAB-18045-B	010	83219	...		...	...
	TQSH-18045-A	010	83309	89446		...	...

## GUÍA DE APLICACIONES – CAMIONES, TRÁILERS Y AUTOBUSES

Año	Modelo	# E.O.	Delantero		Trasero	
						
						
			Fleetline	GasSLX	Fleetline	GasSLX

### FORD (Cont.)

#### Intercambios Adicionales de E.O. (Cont.)

Modelos con Número de E.O.	XC45-18045-AA	010	<b>83216</b>	...	...	...	
	XL2Z-18124-EA	-10	<b>G63678</b>	...	...	...	
	XL2Z-18125-BA		...	...	010	<b>G63679</b>	...
	XL2Z-18125-CA		...	...	010	<b>G63679</b>	...
	XL2Z-18125-EA		...	...	010	<b>G63679</b>	...
	YL5Z-18124-AA	-10	<b>G63772</b>	...	...	...	...
Intercambios Adicionales de E.O.	680029	010	<b>85301</b>				
	C6PF-18077-DD	010	<b>83216</b>				
	C6PF-18077-DE	010	<b>83219</b>				
	C7PF-18077-Z	010	<b>83217</b>				

### FORD AMORTIGUADORES DE CABINA

#### Aplicaciones Adicionales

Modelos con Suspensión Link Cab	1202-0022	010				<b>83046</b>
	1202-0042	010				<b>83025</b>
Tractos CL9000 & CLT9000 (con Dormitorio & sin Dormitorio) con Cabina Abatible Modelo Link Cabmate FCL110-2P	1202-0032	010				<b>83016</b>

#### Series 8500

Modelos con Tractos Convencionales BBC de 101", 113" & 122" con Modelos Link Cabmate FH101, FH1322 & FH1322-A	1201-1043	010				<b>83025</b>
	1202-1043	010				<b>83025</b>

#### Series 9500

Modelos con Número de E.O.	F6HZ-5K407-AB	010				<b>83034</b>
	F6HZ-5K407-BA	010				<b>83033</b>
	F8HT-5K407-AA	010				<b>83033</b>
Modelos con Tractos Convencionales BBC de 101", 113" & 122" con Modelos Link Cabmate FH101, FH1322 & FH1322-A	1201-1043	010				<b>83025</b>
	1202-1043	010				<b>83025</b>

#### Series L - Convencional

Modelos L, LT, LN, LNT 800, 8000, 9000, LTS, LS 8000, 9000 & Modelos LTL, LL 9000 con Modelo Link Cabmate FN89-A	1201-0012	010				<b>83023</b>
	1202-0012	010				<b>83023</b>
Todos con Dormitorios con Cama Modelos Link Bunkmate FAS60-A & FAS60-AS	1201-1044	010				<b>83025</b>
	1202-1044	010				<b>83025</b>





### FOREST RIVER INC

#### MotorHomes Clase A

02 - 04	MotorHomes Series Reflection con Chasis Freightliner XC Amortiguador Trasero con Número de E.O.  Suspensión Delantera AS120  Suspensión Delantera ZF - IFS con PBV de 23,000 lb o mayor  Suspensión Trasera ADL200 de 20K	141700131809					
		16-16736-000					
		141700131810	010	<b>83160</b>	...	...	...
		16-16737-000	010	<b>83160</b>	...	...	...
		16-16874-000	010	<b>83160</b>	...	...	...
		16-18103-000	-1-	<b>85900</b>	...	...	...
		481700000493	-1-	<b>85900</b>	...	...	...
16-16873-000		...	...	010	<b>85029</b>	...	
02 - 06	MotorHomes Series Tsunami con Chasis Freightliner XC Amortiguador Trasero con Número de E.O.  Suspensión Delantera AS120  Suspensión Delantera ZF - IFS con PBV de 23,000 lb o mayor	141700131809					
		16-16736-000					
		141700131810	010	<b>83160</b>	...	...	...
		16-16737-000	010	<b>83160</b>	...	...	...
		16-16874-000	010	<b>83160</b>	...	...	...
		16-18103-000	-1-	<b>85900</b>	...	...	...
		481700000493	-1-	<b>85900</b>	...	...	...



**GUÍA DE APLICACIONES – CAMIONES, TRÁILERS Y AUTOBUSES**

Año	Modelo	# E.O.	Delantero		Trasero	
						
			Fleetline	GasSLX	Fleetline	GasSLX

**FOREST RIVER INC (Cont.)**

**MotorHomes Clase A (Cont.)**

	Suspensión Trasera ADL200 de 20K	16-16873-000		...	...	OIO	<b>85029</b>	...
--	----------------------------------	--------------	--	-----	-----	-----	--------------	-----

**FREIGHTLINER**

**Argosy**

- 98	Modelos con Suspensión de Aire Trasera Freightliner FAS II 680339	16-13957-000		...	...	OIO	<b>85724</b>	<b>89443</b>
				...	...	OIO	<b>85724</b>	<b>89443</b>
99 -	Modelos con Suspensión de Aire Trasera Freightliner FAS II 680611	16-15817-000		...	...	OIO	<b>85724</b>	<b>89443</b>
				...	...	OIO	<b>85724</b>	<b>89443</b>
- 08	Modelos con Suspensión de Aire Trasera Perfil Bajo Freightliner (18,000 a 40,000 lb) 680511	16-14259-000		...	...	OIO	<b>85331</b>	...
				...	...	OIO	<b>85331</b>	...
09 -	Modelos con Suspensión de Aire Trasera Perfil Bajo Freightliner (18,000 a 40,000 lb) 471700002992	16-18706-000		...	...	OIO	<b>85331</b>	...
				...	...	OIO	<b>85331</b>	...
	Modelos con Suspensión Delantera de Muelles de 12000 lb 471700000449	10-13634-000	OIO	<b>85918</b>	<b>89449</b>		...	...
			OIO	<b>85918</b>	<b>89449</b>		...	...
	Modelos con Suspensión Delantera Tapertleaf de 4" 471700000449	10-12703-000	OIO	<b>85918</b>	<b>89449</b>		...	...
			OIO	<b>85918</b>	<b>89449</b>		...	...
	Modelos con Suspensión Trasera Perfil Bajo AirLiner de 10000 lb - 15000 lb 16-18711-000 471700002996	16-16577-000		...	...	OIO	<b>85335</b>	...
				...	...	OIO	<b>85335</b>	...
				...	...	OIO	<b>85335</b>	...





**Business Class - FL50, 60, 70, 80**

	Business Class 6 & 7 con Suspensión Trasera 15000 lb 6803260000			...	...	OIO	<b>83120</b>	...
	FAS Airliner, Producción Pasada Eje Tandem / Sencillo 16-11133-000			...	...	OIO	<b>85007</b>	<b>89412</b>
	Modelos FL con Suspensión de 10,000 a 18,000 lb 471700003009 6803230300 GBL665538	10-13759-000	OIO	<b>85006</b>	...		...	...
			OIO	<b>85006</b>	...		...	...
			OIO	<b>85006</b>	...		...	...
			OIO	<b>85006</b>	...		...	...
- 98	Modelos FL con Suspensión de Aire Trasera FAS II 680339	16-13957-000		...	...	OIO	<b>85724</b>	<b>89443</b>
				...	...	OIO	<b>85724</b>	<b>89443</b>
99 -	Modelos FL con Suspensión de Aire Trasera FAS II 680611	16-15817-000		...	...	OIO	<b>85724</b>	<b>89443</b>
				...	...	OIO	<b>85724</b>	<b>89443</b>
	Modelos FLN con Eje Delantero de 6000 lb a 9000 lb 6803230200	654654	OIO	<b>85043</b>	...		...	...
			OIO	<b>85043</b>	...		...	...

**Business Class - M2**

	Modelos 106 con Eje Delantero 8000 a 16000 lb y Muelles Helicoidales 471700002391		OIO	<b>85959</b>	...		...	...
09 - 15	Modelos con Eje Delantero de 13300 lb a 20000 lb 471700003920	10-13809-000	OIO	<b>85958</b>	...		...	...
			OIO	<b>85958</b>	...		...	...
02 -	Modelos con Eje Delantero de 6000 lb a 9000 lb 10-12388-000		OIO	<b>85920</b>	...		...	...
09 - 14	Modelos con Eje Delantero y Muelles Taperleaf de 8000 a 16000 lb SDA471700002991	10-13760-000	OIO	<b>85959</b>	...		...	...
			OIO	<b>85959</b>	...		...	...
02 -	Modelos con Muelles Traseras de 52", 10000 lb - 15000 lb 16-18710-000 471700002995	16-16486-000		...	...	-IO	<b>83134</b>	...
				...	...	-IO	<b>83134</b>	...
				...	...	-IO	<b>83134</b>	...
02 -	Modelos con Muelles Traseras de 52", 18000 lb - 23000 lb 16-18709-000 471700002994	16-16442-000		...	...	-IO	<b>83134</b>	...
				...	...	-IO	<b>83134</b>	...
				...	...	-IO	<b>83134</b>	...
02 -	Modelos con Muelles Traseras de 60", 18000 lb - 23000 lb 16-18707-000 471700002993	16-15765-000		...	...	-IO	<b>85921</b>	...
				...	...	-IO	<b>85921</b>	...
				...	...	-IO	<b>85921</b>	...
02 - 08	Modelos con Suspensión de Aire Trasera FAS II 680611	16-15817-000		...	...	OIO	<b>85724</b>	<b>89443</b>
				...	...	OIO	<b>85724</b>	<b>89443</b>
09 - 15	Modelos con Suspensión de Aire Trasera FAS II 16-18708-000			...	...	OIO	<b>85724</b>	<b>89443</b>

**GUÍA DE APLICACIONES – CAMIONES, TRÁILERS Y AUTOBUSES**

Año	Modelo	# E.O.	Delantero		Trasero	
						
			Fleetline	GasSLX	Fleetline	GasSLX

**FREIGHTLINER (Cont.)**

**Business Class - M2 (Cont.)**

09 - 15	Modelos con Suspensión de Aire Trasera FAS II	471700002809		...	...	010	85724	89443
		SDA471700002809		...	...	010	85724	89443
- 08	Modelos con Suspensión de Aire Trasera Perfil Bajo Freightliner (18,000 a 40,000 lb)	16-14259-000		...	...	010	85331	...
		680511		...	...	010	85331	...
09 -	Modelos con Suspensión de Aire Trasera Perfil Bajo Freightliner (18,000 a 40,000 lb)	16-18706-000		...	...	010	85331	...
		471700002992		...	...	010	85331	...
02 - 08	Modelos con Suspensión de Muelles Taperleaf de 10000 a 12000 lb	10-12390-000	010	85920	...		...	...
- 04	Modelos con Suspensión Delantera de Muelles	10-13211-000	010	85918	89449		...	...
		471700131155	010	85918	89449		...	...
05 - 08	Modelos con Suspensión Delantera de Muelles	471700000449	010	85918	89449		...	...
05 - 08	Modelos con Suspensión Delantera de Muelles de 12000 lb	10-13634-000	010	85918	89449		...	...
		471700000449	010	85918	89449		...	...
02 -	Modelos con Suspensión Trasera Perfil Bajo AirLiner de 10000 lb - 15000 lb	16-16577-000		...	...	010	85335	...
		16-18711-000		...	...	010	85335	...
		471700002996		...	...	010	85335	...

**Cargo - FC70 & FC80**

	Modelos FC70 & FC80 con Suspensión de 10,000 a 18,000 lb	10-13759-000	010	85006	...		...	...
		471700003009	010	85006	...		...	...
		6803230300	010	85006	...		...	...
		GBL665538	010	85006	...		...	...
	Modelos FC70 o FC80 con Eje Delantero de 6000 lb a 9000 lb	654654	010	85043	...		...	...
		6803230200	010	85043	...		...	...
- 98	Modelos FC70 o FC80 con Suspensión Trasera de Aire FAS II	16-13957-000		...	...	010	85724	89443
		680339		...	...	010	85724	89443
99 -	Modelos FC70 o FC80 con Suspensión Trasera de Aire FAS II	16-15817-000		...	...	010	85724	89443
		680611		...	...	010	85724	89443









**Cascadia**

- 08	Modelos con Suspensión de Aire Trasera FAS II de 40000 lb	16-15817-000		...	...	010	85724	89443
		680611		...	...	010	85724	89443
09 - 15	Modelos con Suspensión de Aire Trasera FAS II de 40000 lb	16-18708-000		...	...	010	85724	89443
		471700002809		...	...	010	85724	89443
		SDA471700002809		...	...	010	85724	89443
09 - 15	Modelos con Suspensión Delantera de Muelles de 12000 lb a 13300 lb	10-13809-000	010	85958	...		...	...
		SDA471400003920	010	85958	...		...	...
- 08	Modelos con Suspensión Delantera de Muelles de 12000 lb	10-13634-000	010	85918	89449		...	...
		471700000449	010	85918	89449		...	...
		471700000449	010	85918	89449		...	...

**Century Class - C112 & C120**

	Modelos con Perfil Bajo Delantero	10-12703-000	010	85918	89449		...	...
- 98	Modelos con Suspensión de Aire Trasera FAS II	16-13957-000		...	...	010	85724	89443
		680339		...	...	010	85724	89443
09 - 15	Modelos con Suspensión de Aire Trasera FAS II	16-18708-000		...	...	010	85724	89443
		471700002809		...	...	010	85724	89443
		SDA471700002809		...	...	010	85724	89443
99 - 08	Modelos con Suspensión de Aire Trasera FAS II	16-15817-000		...	...	010	85724	89443
		680611		...	...	010	85724	89443
- 08	Modelos con Suspensión de Aire Trasera Perfil Bajo Freightliner (18,000 a 40,000 lb)	16-14259-000		...	...	010	85331	...
		680511		...	...	010	85331	...
09 -	Modelos con Suspensión de Aire Trasera Perfil Bajo Freightliner (18,000 a 40,000 lb)	16-18706-000		...	...	010	85331	...
		471700002992		...	...	010	85331	...

## GUÍA DE APLICACIONES – CAMIONES, TRÁILERS Y AUTOBUSES

Año	Modelo	# E.O.	Delantero		Trasero	
						
						
			Fleetline	GasSLX	Fleetline	GasSLX

### FREIGHTLINER (Cont.)

#### Century Class - C112 & C120 (Cont.)

<b>00 - 09</b>	Modelos con Suspensión Delantera de Muelles de 12000 lb	10-13021-000	010	<b>85918</b>	89449		...	...
		10-13063-000	010	<b>85918</b>	89449		...	...
		10-13211-000	010	<b>85918</b>	89449		...	...
		10-13634-000	010	<b>85918</b>	89449		...	...
		471700000449	010	<b>85918</b>	89449		...	...
		471700000449	010	<b>85918</b>	89449		...	...
		471700131155	010	<b>85918</b>	89449		...	...
<b>97 - 99</b>	Modelos con Suspensión Delantera de Muelles de 12000 lb	10-12542-000	010	<b>85901</b>	...		...	...
<b>02 - 09</b>	Modelos con Suspensión Delantera Hendrickson AirTek	471700131331	010	<b>85932</b>	89453		...	...
		58913-003	010	<b>85932</b>	89453		...	...





#### Classic/ClassicXL

<b>- 98</b>	Modelos con Suspensión de Aire Trasera FAS II	16-13957-000		...	...	010	<b>85724</b>	89443
		680339		...	...	010	<b>85724</b>	89443
<b>09 - 15</b>	Modelos con Suspensión de Aire Trasera FAS II	16-18708-000		...	...	010	<b>85724</b>	89443
		471700002809		...	...	010	<b>85724</b>	89443
		SDA471700002809		...	...	010	<b>85724</b>	89443
<b>99 - 08</b>	Modelos con Suspensión de Aire Trasera FAS II	16-15817-000		...	...	010	<b>85724</b>	89443
		680611		...	...	010	<b>85724</b>	89443
<b>00 - 09</b>	Modelos con Suspensión Delantera de Muelles de 12000 lb	10-13021-000	010	<b>85918</b>	89449		...	...
		10-13063-000	010	<b>85918</b>	89449		...	...
		10-13211-000	010	<b>85918</b>	89449		...	...
		10-13634-000	010	<b>85918</b>	89449		...	...
		471700000449	010	<b>85918</b>	89449		...	...
		471700000449	010	<b>85918</b>	89449		...	...
		471700131155	010	<b>85918</b>	89449		...	...
<b>- 09</b>	Modelos con Suspensión Delantera Hendrickson AirTek	471700131331	010	<b>85932</b>	89453		...	...
		58913-003	010	<b>85932</b>	89453		...	...
	Modelos con Número de E.O.	10-12032-002	010	<b>85320</b>	89429		...	...
		10-12032-004	010	<b>85320</b>	89429		...	...
		680009	010	<b>85302</b>	89420		...	...
		70029	010	<b>85308</b>	89422		...	...

#### Columbia

	Modelos 560 con Suspensión de Aire Trasera FAS II	471700002808		...	...	010	<b>85724</b>	89443
	Modelos con Número de E.O.	10-13684-000	010	<b>85918</b>	89449		...	...
		471700000470	010	<b>85918</b>	89449		...	...
<b>09 - 15</b>	Modelos con Suspensión de Aire Trasera FAS II	16-18708-000		...	...	010	<b>85724</b>	89443
		471700002809		...	...	010	<b>85724</b>	89443
		SDA471700002809		...	...	010	<b>85724</b>	89443
<b>99 - 08</b>	Modelos con Suspensión de Aire Trasera FAS II	16-15817-000		...	...	010	<b>85724</b>	89443
		680611		...	...	010	<b>85724</b>	89443
<b>00 - 08</b>	Modelos con Suspensión Delantera de Muelles de 12000 lb	10-13021-000	010	<b>85918</b>	89449		...	...
		10-13063-000	010	<b>85918</b>	89449		...	...
		10-13211-000	010	<b>85918</b>	89449		...	...
		10-13634-000	010	<b>85918</b>	89449		...	...
		471700000449	010	<b>85918</b>	89449		...	...
		471700000449	010	<b>85918</b>	89449		...	...
		471700131155	010	<b>85918</b>	89449		...	...
<b>09 - 15</b>	Modelos con Suspensión Delantera de Muelles de 12000 lb	10-13809-000	010	<b>85958</b>	...		...	...
		SDA471400003920	010	<b>85958</b>	...		...	...
<b>02 - 05/10</b>	Modelos con Suspensión Delantera Hendrickson AirTek	471700131331	010	<b>85932</b>	89453		...	...
		58913-003	010	<b>85932</b>	89453		...	...
<b>06/10 -</b>	Modelos con Suspensión Delantera Hendrickson AirTek	471700006269	010	<b>85932</b>	89453		...	...
		58913-012	010	<b>85932</b>	89453		...	...

**GUÍA DE APLICACIONES – CAMIONES, TRÁILERS Y AUTOBUSES**

Año	Modelo	# E.O.	Delantero		Trasero	
						
			Fleetline	GasSLX	Fleetline	GasSLX

**FREIGHTLINER (Cont.)**

**Coronado (Cont.)**

09 - 15	Modelos con Eje Delantero de 12,000 a 20,000 lb	10-13809-000 471700003920	010	85958	...	...	...
			010	85958	...	...	...
04 - 08	Modelos con Suspensión de Aire Trasera FAS II	16-15817-000 680611		...	...	010	85724 89443
				...	...	010	85724 89443
09 - 15	Modelos con Suspensión de Aire Trasera FAS II de 40000 lb	16-18708-000 471700002809 SDA471700002809		...	...	010	85724 89443
				...	...	010	85724 89443
				...	...	010	85724 89443
08 - 11	Modelos con Suspensión de Aire Trasera TufTrac Freightliner	481700125969		...	...	010	85956 ...
08 - 15	Modelos con Suspensión de Aire Trasera TufTrac Freightliner	16-15770-000		...	...	010	85956 ...
04 - 09	Modelos con Suspensión Delantera de Muelles de 12000 lb	10-13211-000 471700131155	010	85918	89449		...
			010	85918	89449		...
04 -	Modelos con Suspensión Delantera Hendrickson AirTek	471700006269 471700131331 58913-003 58913-012	010	85932	89453		...
			010	85932	89453		...
			010	85932	89453		...
			010	85932	89453		...
- 14	Modelos con Suspensión Trasera Chalmers de 46,000 lb	665174		...	...	010	85060 ...

**Series FL**

	Modelos FL 360	MK632642		...	...	010	83510 ...
--	----------------	----------	--	-----	-----	-----	-----------









**Series FLA & FLB - COE Camión & Tractor**

	Modelos COE	10-12030-002 10-12032-000 10-12032-001 10-12032-002 10-12032-003 10-12032-004	010	85320	89429		...
			010	85320	89429		...
			010	85320	89429		...
			010	85320	89429		...
			010	85320	89429		...
			010	85320	89429		...
	Modelos COE con Cámaras de Aire de Fuelle	16-12117-000 16-18705-000 471700002990 665236		...	...	010	85007 89412
				...	...	010	85007 89412
				...	...	010	85007 89412
				...	...	010	85007 89412
- 94	Modelos COE con Cámaras de Aire Tipo Lóbulo Enrollado	16-13947-000 681-326-0400		...	...	-10	85319 89428
				...	...	-10	85319 89428
	Modelos COE con Suspensión de Aire Neway Eje Tarjeta	90044162		...	...	010	83128 89436
- 98	Modelos COE con Suspensión Trasera de Aire FAS II	16-13957-000 680339		...	...	010	85724 89443
				...	...	010	85724 89443
99 -	Modelos COE con Suspensión Trasera de Aire FAS II	16-15817-000 680611		...	...	010	85724 89443
				...	...	010	85724 89443

**Series FLC & FLD - 112 & 120 Camión & Tractor Convencional**

09 - 15	Modelos con Suspensión de Aire Trasera FAS II	16-18708-000 471700002809 SDA471700002809		...	...	010	85724 89443
				...	...	010	85724 89443
				...	...	010	85724 89443
08 - 10	Modelos con Suspensión de Aire Trasera TufTrac Freightliner	SDA481700125969		...	...	010	85956 ...
08 - 11	Modelos con Suspensión de Aire Trasera TufTrac Freightliner	481700125969		...	...	010	85956 ...
08 - 15	Modelos con Suspensión de Aire Trasera TufTrac Freightliner	16-15770-000		...	...	010	85956 ...
09 - 15	Modelos con Suspensión Delantera de Muelles de 12000 lb	10-13809-000 SDA471400003920	010	85958	...		...
			010	85958	...		...
	Modelos Convencionales con Cámaras de Aire de Fuelle	16-12117-000 16-18705-000 471700002990 665236		...	...	010	85007 89412
				...	...	010	85007 89412
				...	...	010	85007 89412
				...	...	010	85007 89412
- 94	Modelos Convencionales con Cámaras de Aire Tipo Lóbulo Enrollado	16-13947-000 681-326-0400		...	...	-10	85319 89428
				...	...	-10	85319 89428
	Modelos Convencionales con Número de E.O.	10-12030-002 10-12032-000 10-12032-001	010	85320	89429		...
			010	85320	89429		...
			010	85320	89429		...

## GUÍA DE APLICACIONES – CAMIONES, TRÁILERS Y AUTOBUSES

Año	Modelo	# E.O.	Delantero		Trasero	
						
						
			Fleetline	GasSLX	Fleetline	GasSLX

### FREIGHTLINER (Cont.)

#### Series FLC & FLD - 112 & 120 Camión & Tractor Convencional (Cont.)

	Modelos Convencionales con Número de E.O.	10-12032-002	010	<b>85320</b>	89429		...	...
		10-12032-003	010	<b>85320</b>	89429		...	...
		10-12032-004	010	<b>85320</b>	89429		...	...
<b>00 - 09</b>	Modelos Convencionales con Suspensión Delantera de Muelles de 12000 lb	10-13021-000	010	<b>85918</b>	89449		...	...
		10-13063-000	010	<b>85918</b>	89449		...	...
		10-13211-000	010	<b>85918</b>	89449		...	...
		10-13634-000	010	<b>85918</b>	89449		...	...
		471700000449	010	<b>85918</b>	89449		...	...
		471700000449	010	<b>85918</b>	89449		...	...
<b>02 - 09</b>	Modelos Convencionales con Suspensión Delantera Hendrickson Airtek	471700131331	010	<b>85932</b>	89453		...	...
		58913-003	010	<b>85932</b>	89453		...	...
	Modelos Convencionales con Suspensión Neway Eje Tarjeta	90044162		...	...	010	<b>83128</b>	89436
<b>- 98</b>	Modelos Convencionales con Suspensión Trasera de Aire FAS II	16-13957-000		...	...	010	<b>85724</b>	89443
		680339		...	...	010	<b>85724</b>	89443
<b>99 - 08</b>	Modelos Convencionales con Suspensión Trasera de Aire FAS II	16-15817-000		...	...	010	<b>85724</b>	89443
		680611		...	...	010	<b>85724</b>	89443

#### Series Legacy

	Modelos con Número de E.O.	681-323-0900	-10	<b>85009</b>	...		...	...
<b>- 98</b>	Modelos con Suspensión de Aire Trasera FAS II	16-13957-000		...	...	010	<b>85724</b>	89443
		680339		...	...	010	<b>85724</b>	89443
<b>99 -</b>	Modelos con Suspensión de Aire Trasera FAS II	16-15817-000		...	...	010	<b>85724</b>	89443
		680611		...	...	010	<b>85724</b>	89443

#### Series Severe Duty

<b>- 14</b>	Modelos 108 SD con Eje Delantero 8000 a 16000 lb y Muelles Helicoidales	10-13760-000	010	<b>85959</b>	...		...	...
<b>- 14</b>	Modelos 108 SD con Suspensión de Aire Trasera Freightliner TufTrac	481700125969		...	...	010	<b>85956</b>	...
<b>- 15</b>	Modelos 108 SD con Suspensión de Aire Trasera Freightliner TufTrac	16-15770-000		...	...	010	<b>85956</b>	...
<b>11 - 14</b>	Modelos 114 SD con Eje Delantero 20000 lb	10-13934-000	01-	<b>85123</b>	...		...	...
		471700006929	01-	<b>85123</b>	...		...	...
<b>- 14</b>	Modelos 114 SD con Número de E.O.	10-13684-000	010	<b>85918</b>	89449		...	...
<b>- 14</b>	Modelos 114 SD con Suspensión de Aire Trasera Freightliner TufTrac	481700125969		...	...	010	<b>85956</b>	...
<b>- 15</b>	Modelos 114 SD con Suspensión de Aire Trasera Freightliner TufTrac	16-15770-000		...	...	010	<b>85956</b>	...

#### Intercambios Adicionales de E.O.

	Modelos con Número de E.O.	10-12046-000	010	<b>85320</b>	89429		...	...
		10-12594-000	010	<b>85984</b>	...		...	...
		10-13592-000	010	<b>85959</b>	...		...	...
		16-10688-000		...	...	010	<b>85042</b>	...
		16-14577-000	010	<b>85043</b>	...		...	...
		16-14669-000	010	<b>G63403</b>	...		...	...
		16-14759-000	010	<b>85000</b>	89436		...	...
		16-16781-000	010	<b>85108</b>	...		...	...
		16-16782-000		...	...	01-	<b>85096</b>	...
		16-16868-000	010	<b>85095</b>	...		...	...
		16-19138-000	010	<b>85058</b>	89431		...	...
		3638112		...	...	010	<b>G63183</b>	...
		4036892	010	<b>G63605</b>	...		...	...
		471700000440	010	<b>85959</b>	...		...	...
		471700002991	010	<b>85959</b>	...		...	...
47902-13		...	...	010	<b>83122</b>	89406		

## GUÍA DE APLICACIONES – CAMIONES, TRÁILERS Y AUTOBUSES

Año	Modelo	# E.O.	Delantero		Trasero	
			Fleetline	GasSLX	Fleetline	GasSLX

### FREIGHTLINER (Cont.)

#### Intercambios Adicionales de E.O. (Cont.)

	Modelos con Número de E.O.	535228	010	<b>85302</b>	89420		...	...
	61300224	010	<b>85918</b>	89449		...	...	
	61300240	010	<b>85918</b>	89449		...	...	
	650224		...	...	010	<b>83225</b>	...	
	651352		...	...	010	<b>85042</b>	...	
	651356		...	...	010	<b>83634</b>	...	
	654725		...	...	01-	<b>83120</b>	...	
	654875		...	...	010	<b>83117</b>	...	
	654918		<b>83118</b>	...		...	...	
	659060		<b>85920</b>	...		...	...	
	659062		...	...	-10	<b>83134</b>	...	
	659063		...	...	-10	<b>83134</b>	...	
	659300		<b>85005</b>	<b>89430</b>		...	...	
	660235		...	...	010	<b>85042</b>	...	
	665409		<b>85009</b>	...		...	...	
	671908		<b>85918</b>	<b>89449</b>		...	...	
	671945		<b>85920</b>	...		...	...	
	671946		...	...	-10	<b>85921</b>	...	
	680009		<b>85302</b>	<b>89420</b>		...	...	
	680442		...	...	-10	<b>85319</b>	<b>89428</b>	
	680651		...	...	010	<b>85335</b>	...	
	680782		<b>85302</b>	<b>89420</b>		...	...	
	6813230900		<b>85009</b>	...		...	...	
	6813260000		...	...	010	<b>83634</b>	...	
	6813260200		...	...	010	<b>85011</b>	...	
70029		<b>85308</b>	<b>89422</b>		...	...		
70042		<b>85302</b>	<b>89420</b>		...	...		
SDA471700000440		<b>85959</b>	...		...	...		
Modelos con Suspensión de Aire Neway con estampado en el amortiguador	90045083		...	...	010	<b>85910</b>	...	
Modelos con Suspensión Delantera de 7000 lb	10-13776-000		<b>85005</b>	<b>89430</b>		...	...	
Intercambios Adicionales de E.O.	10-13051-001	010	<b>85005 or 89430</b>					
	10-13205-000	010	<b>85918</b>	<b>89449</b>		...		
	10-13859-000	010	<b>85005 or 89430</b>					
	16-14667-000	010	<b>85005 or 89430</b>					
	16-14668-000	010	<b>83127</b>					
	16-15591-000	010	<b>85043</b>					
	16-16765-000	010	<b>85006</b>					
	16-17759-000	010	<b>85919</b>					
	16-18094-000	010	<b>85959</b>					
	471700131646	010	<b>85918</b>	<b>89449</b>		...		
	680008	010	<b>85300 or 89419</b>					
	680017	010	<b>85302 or 89420</b>					
	681-323-1100	010	<b>85301</b>					

### FREIGHTLINER AMORTIGUADORES DE CABINA

#### Aplicaciones Adicionales

	Modelos con Dormitorio de 60" con Modelo Link Bunkmate FRTS60-A	1202-1043	010					<b>83025</b>
	Modelos con Número de E.O.	18-41762-002	010					<b>83038</b>
		18-42613-000	010					<b>83033</b>
		18-43504-000	010					<b>83057</b>
		18-44321-000	010					<b>83009</b>
		18-45067-000	010					<b>83034</b>
		18-60295-000	010					<b>83006</b>

## GUÍA DE APLICACIONES – CAMIONES, TRÁILERS Y AUTOBUSES

Año	Modelo	# E.O.	Delantero		Trasero	
			Fleetline	GasSLX	Fleetline	GasSLX

### FREIGHTLINER AMORTIGUADORES DE CABINA (Cont.)

#### Aplicaciones Adicionales (Cont.)

	Modelos con Número de E.O.	18-60765-000	010	83047
		18-60768-000	010	83057
		18-60769-000	010	83009
		18-60772-000	010	83026
		18-60773-000	01-	83027
		650361	010	83017
		654739	010	83009
		654819	010	83001
		654831	010	83006
		654841	010	83020
		654990	010	83038
		659079	010	83040
		659080	010	83039
		659125	010	83047
		659178	010	83038
		659288	010	83006
	814903003496	010	83009	
	Modelos con Suspensión Link Cab	1202-0042	010	83025
		1202-0043	010	83032
		1202-0044	010	83025

#### Argosy

00 - 06	Modelos con Número de E.O.	18-37813-000	010	83044
---------	----------------------------	--------------	-----	-------

#### Business Class - M2

02 -	Camiones con Suspensiones de Aire	18-47350-000	010	83040
02 -	Camiones con Suspensiones de Muelles	18-47349-000	010	83039
09 -	M2 - Business Class con Número de E.O.	18-60767-000	010	83039
		814903003483	010	83039
09 - 14	Modelos con Suspensión de Muelles	814903003482	010	83040
09 - 15	Modelos con Suspensión de Muelles	18-60766-000	010	83040
09 -	Modelos Crew Cab con Número de E.O.	18-60768-000	010	83057
		814903003484	010	83057

#### Cascadia

09 - 14	Modelos con Dormitorio de Techo Alto de 72"	814903003528	010	83038
09 - 15	Modelos con Dormitorio de Techo Alto de 72"	18-60764-000	010	83038

#### Century Class

	Cabinas Dormitorio con Número de E.O.	18-30378-000	010	83001
		18-32999-000	010	83001
	Modelos con Número de E.O.	18-41762-000	010	83038
	Suspensiones Day Cab con Número de E.O.	18-32999-001	010	83006

#### Classic

	Modelos con Número de E.O.	18-29846-000	010	83009
--	----------------------------	--------------	-----	-------

#### Columbia

	Modelos con Cabina Dormitorio y Número de E.O.	18-41762-000	010	83038
		814903003528	010	83038
09 - 11	Modelos con Dormitorio de Techo Alto de 72"	814903003528	010	83038
09 - 15	Modelos con Dormitorio de Techo Alto de 72"	18-60764-000	010	83038
	Modelos con Número de E.O.	18-29846-000	010	83009

#### Coronado

	Modelos con Dormitorio de Techo Medio de 72"	18-41762-002	010	83038
		18-60765-002	010	83038
09 -	Modelos con Dormitorio de Techo Medio de 72"	18-60765-002	010	83038
04 - 09	Modelos con Número de E.O.	18-41762-000	010	83038
09 - 14	Modelos con Número de E.O.	814903003528	010	83038
09 - 15	Modelos con Número de E.O.	18-60764-000	010	83038

## GUÍA DE APLICACIONES – CAMIONES, TRÁILERS Y AUTOBUSES

Año	Modelo	# E.O.	Delantero		Trasero	
			Fleetline	GasSLX	Fleetline	GasSLX

### FREIGHTLINER AMORTIGUADORES DE CABINA (Cont.)

#### FL112 Convencional (Cont.)

97 -	Tractos FL112 Business Class Day Cab con Modelo Link Cabmate FRT112DC	1202-1044	010	<b>83025</b>
------	---	-----------	-----	--------------

#### FLA - COE Camiones & Tractores

	Modelos con Número de E.O.	681-891-02-05	010	<b>83017</b>
84 -	Tractos con Cabina Abatible Modelo Link Cabmate FRT285 de 86", 96" & 104"	1202-0032	010	<b>83016</b>

#### FLB - COE Camiones & Tractores

93 -	Cabinas de 90", 100", y 110" con Modelos Link Cabmate FRT46-2P-A o FRT46-2P-B	1201-0054	010	<b>83021</b>
84 -	Modelos con Cabinas de 86", 96" & 104" con Modelo Link Cabmate FRT285-A	1202-0022	010	<b>83046</b>
84 -	Tractos con Cabina Abatible Modelo Link Cabmate FRT285 de 86", 96" & 104"	1202-0032	010	<b>83016</b>
	Tractos con Cabina Abatible Modelos Link Cabmate FRT50-2P-C con distancia entre centros de 50" o 54" en montajes traseros	1202-0054	010	<b>83021</b>

#### FLC - 112 & 120 Tractores Convencionales

- 03/88	Modelos con Suspensión de Aire Link Cab FRTC120-A o FRTC120-AW	1201-0012	010	<b>83023</b>
		1202-0012	010	<b>83023</b>
89 -	Tractos Convencionales con Modelo Link Cabmate FRTE120-A	1201-1043	010	<b>83025</b>
		1202-1043	010	<b>83025</b>
97 -	Tractos FL112 Business Class Day Cab con Modelo Link Cabmate FRT112DC	1201-1044	010	<b>83025</b>

#### Series ACTERRA

09 -	Modelos con Número de E.O.	18-60768-000	010	<b>83057</b>
		814903003484	010	<b>83057</b>

#### Series FL 60, 70, 80 & 106 - Business Class Convencional

91 -	Camiones con Modelos Link Cabmate FRT153BC-A, FRT106BC o FRT106HD-A	1201-0054	010	<b>83021</b>
		1202-0054	010	<b>83021</b>
	Modelos con Número de E.O.	18-30378	010	<b>83006</b>

#### Series FLD - 112 & 120 Camión & Tractor Convencional

09/93 -	Cabina con Cama de 64" con Modelos Link Bunkmate FRTA64 o FRTAS64-A	1202-1044	010	<b>83025</b>
	Cabina D2	18-41762-001	010	<b>83047</b>
		18-60765-001	010	<b>83047</b>
		814903003486	010	<b>83047</b>
	FLD Dormitorio con Suspensión de Aire	18-29846-000	010	<b>83009</b>
01 - 12	FLD Dormitorio con Suspensión de Aire	18-29846-001	010	<b>83064</b>
	FLD112 Daycab con Suspensión de Aire	18-31476-000	010	<b>83020</b>
89 -	Tractos Convencionales con Modelo Link Cabmate FRTE120-A	1202-1043	010	<b>83025</b>

#### Series Severe Duty









- 14	Modelos 108 SD con Número de E.O.	814903003482	010	<b>83040</b>
- 15	Modelos 108 SD con Número de E.O.	18-60766-000	010	<b>83040</b>
- 14	Modelos 114 SD con Número de E.O.	814903003482	010	<b>83040</b>
- 15	Modelos 114 SD con Número de E.O.	18-60766-000	010	<b>83040</b>

### FREIGHTLINER CUSTOM CHASSIS

09-12	Autobús Escolar Tipo C con Número de E.O.	16-18713-000 471700003070	010	...	...	01-	<b>85122</b>	...
				...	...	01-	<b>85122</b>	...
	Autobús Shuttle MB55 con Suspensión Delantera de Hojas Planas de 8000 lb	16-15676-000	010	<b>85058</b>	89431		...	...
	Camiones FedEx con Número de E.O.	MAE16950	010	<b>83118</b>	...		...	...
		P117146	010	<b>83118</b>	...		...	...
	Chasis de Autobús Shuttle	16-16082-000	010	<b>85043</b>	...		...	...
	Chasis de Autobús Shuttle FB con Número de E.O.	16-16765-000	010	<b>85006</b>	...		...	...
		471700131775	010	<b>85006</b>	...		...	...





## GUÍA DE APLICACIONES – CAMIONES, TRÁILERS Y AUTOBUSES

Año	Modelo	# E.O.	Delantero		Trasero	
						
						
			Fleetline	GasSLX	Fleetline	GasSLX

### FREIGHTLINER CUSTOM CHASSIS (Cont.)

	Chasis F65 para Autobús Escolar con Suspensión desde 10000 hasta 18000 lb	10-13759-000	010	85006	...		...	...
		471700003009	010	85006	...		...	...
		6803230300	010	85006	...		...	...
		GBL665538	010	85006	...		...	...
	Chasis F65 para Autobús Escolar Modelo	6803260000		...	...	01-	83120	...
		GBL654725		...	...	01-	83120	...
03 - 07	Chasis Freightliner XC	141700131809		...	...	010	85029	...
	Amortiguador Trasero con Número de E.O.	16-16736-000		...	...	010	85029	...
	Suspensión Delantera AS120	141700131810	010	83160	...		...	...
		16-16737-000	010	83160	...		...	...
		16-16874-000	010	83160	...		...	...
	Suspensión Delantera ZF - IFS con PBV de 23,000 lb o mayor	16-18103-000	-1-	85900	...		...	...
		481700000493	-1-	85900	...		...	...
	Suspensión Trasera ADL200 de 20K	16-16873-000		...	...	010	85029	...
Chasis MB55	16-17759-000	010	85919	...		...	...	
	471700000447	010	85919	...		...	...	
Chasis MC con Suspensión Delantera Hendrickson Softtek	16-18094-000	010	85959	...		...	...	
	471700000466	010	85959	...		...	...	
96 - 99	Chasis MC para Motorhomes Clase A	654918	010	83118	...		...	...
		P117099		...	...	01-	83120	...
		P117146	010	83118	...		...	...
Chasis MC-L con Suspensión de 9,000 lb	16-18455-000	010	85918	89449		...	...	
	471700002726	010	85918	89449		...	...	
06 - 08	Chasis Motor Diesel Delantero (FRED)	16-18095-000		...	...	01-	85092	...
		16-18455-000	010	85918	89449		...	...
		471700000467		...	...	01-	85092	...
		471700002726	010	85918	89449		...	...
Chasis MP 14 y MP 19	16-15475-000	010	83164	...		...	...	
Chasis para Autobús Escolar con Suspensión de 7000 lb	10-13859-000	010	85005	89430		...	...	
	471700005079	010	85005	89430		...	...	
Chasis Step Van y Motorhome con Número de E.O.	16-15475-000	010	83164	...		...	...	
03 - 07	Chasis VC	141700131809		...	...	010	85029	...
	Amortiguador Trasero con Número de E.O.	16-16736-000		...	...	010	85029	...
	Suspensión Delantera ZF - IFS con PBV de 23,000 lb o mayor	16-18103-000	-1-	85900	...		...	...
		481700000493	-1-	85900	...		...	...
	Suspensión Trasera ADL200 de 20K	16-16873-000		...	...	010	85029	...
	471700131974		...	...	010	85029	...	
93 - 04	Chasis VC (PBV hasta 22000 lb)	.....	010	83160	...		...	...
93 - 04	Chasis XC (Hasta PBV 22000)	.....	010	83160	...		...	...
00 - 02	Chasis XCS (PBV 22000 lb) con Número de E.O.	16-15592-000	01-	83154	...		...	...
		16-15755-000	010	85043	...		...	...
		16-16043-000	010	85043	...		...	...
01 - 02	Chasis XCS con Suspensión de Aire Trasera Freightliner	16-16093-000	010	83160	...		...	...
Fleetwood Motor Home con Número de E.O.	651375	010	83119	...		...	...	
	RW24285	010	83119	...		...	...	
M-Line Walk in Van con Número de E.O.	MAE 16949		...	...	01-	83120	...	
	MAE 16950	010	83118	...		...	...	
	P117099		...	...	01-	83120	...	
	P117146	010	83118	...		...	...	
Modelos MB55 & MT55	16-17684-000	010	85058	89431		...	...	
Modelos Step Van con Número de E.O.	16-19138-000	010	85058	89431		...	...	

**GUÍA DE APLICACIONES – CAMIONES, TRÁILERS Y AUTOBUSES**

Año	Modelo	# E.O.	Delantero		Trasero	
						
			Fleetline	GasSLX	Fleetline	GasSLX





**FREIGHTLINER CUSTOM CHASSIS (Cont.)**

	Modelos Step Van con Número de E.O.	471700003011	010	<b>85058</b>	<b>89431</b>		...	...
	MP 14 y 19 (UPS)	P117253	010	<b>83116</b>	...		...	...
	MT135	GBL654875		...	...	010	<b>83117</b>	...
	MT45 Step Van	16-15394-000		...	...	01-	<b>83120</b>	...
	MT45 Step Van con Muelles Delanteros de 35"	16-15473-000	010	<b>83157</b>	...		...	...
		16-15474-000	010	<b>83157</b>	...		...	...
	MT45 Step Van con Muelles Delanteros de 38"	16-15089-000	010	<b>83164</b>	...		...	...
	MT55 Step Van	16-15436-000		...	...	01-	<b>83154</b>	...
		16-15705-000		...	...	01-	<b>83120</b>	...
		16-15934-000		...	...	01-	<b>83120</b>	...
		16-16262-000		...	...	01-	<b>83120</b>	...
		16-16542-000		...	...	01-	<b>83154</b>	...
	MT55 Step Van con Muelles Delanteros de 35"	16-15473-000	010	<b>83157</b>	...		...	...
		16-15474-000	010	<b>83157</b>	...		...	...
	MT55 Step Van con Muelles Delanteros de 38"	16-15089-000	010	<b>83164</b>	...		...	...
	MT55 Utility Van con Suspensión Delantera de Muelles de 8000 lb.	16-15676-000	010	<b>85058</b>	<b>89431</b>		...	...
	Oshkosh Motor Home con Número de E.O.	1398980	010	<b>83127</b>				
		GBL654875		...	...	010	<b>83117</b>	...
	Chasis Motor Home XC & XB con Suspensión Delantera Neway AS-120 de 10,500 lb	141700000377	010	<b>83174</b>	...		...	...
		16-18075-000	010	<b>83174</b>	...		...	...
	Chasis Motor Home XC & XB con Suspensión Delantera Neway AS-120 de 12,000 lb	141700000378	010	<b>83160</b>	...		...	...
		141700131975	010	<b>83160</b>	...		...	...
		16-16874-000	010	<b>83160</b>	...		...	...
		16-18076-000	010	<b>83160</b>	...		...	...
	Chasis MotorHome XC con Suspensión Delantera ZF – IFS de 12,000 lb	16-17144-000	-1-	<b>85900</b>	...		...	...
		16-17361-000	-1-	<b>85900</b>	...		...	...
		481700000477	-1-	<b>85900</b>	...		...	...
		481700131919	-1-	<b>85900</b>	...		...	...
	Modelos con Número de E.O.	16-14794-000		...	...	01-	<b>83154</b>	...
		16-16083-000		...	...	010	<b>85331</b>	...
		16-16836-000		...	...	01-	<b>83154</b>	...
		654870	010	<b>83116</b>	...		...	...
		654953	010	<b>85058</b>	<b>89431</b>		...	...
		659227	010	<b>85058</b>	<b>89431</b>		...	...
		GBL654918	010	<b>83118</b>	...		...	...
	Intercambios Adicionales de E.O.	10-13358-000	010	<b>85904</b>				
		16-15805-000	01-	<b>83120</b>				
		1745500	010	<b>89430</b>				
		659104	010	<b>85904</b>				
		665545401	010	<b>89430</b>				
		P116168	010	<b>83117</b>				

**FRUEHAUF**

	Eje Levantado para Tracto & Tráiler con Número de E.O.	5116-117		...	...	010	<b>83122</b>	<b>89406</b>
	Modelo UCA-5431	5352858		...	...	010	<b>85305</b>	...
	Modelo W24T1 Air Ride	UCE-2983-000		...	...	010	<b>85322</b>	...
		UCE-2983-001		...	...	010	<b>85322</b>	...
	Montaje Inferior Modelo "T" con Plataforma de Remolque Escalonada de 48 ft	.....		...	...	010	<b>85327</b>	...
	Suspensiones "L"	UCD-006216-001		...	...	010	<b>83203</b>	<b>89436</b>
	Suspensiones "T"	UCE-1295-901		...	...	010	<b>85300</b>	<b>89419</b>
	Suspensiones en "T" con Carrocería de Volteo (Suspensión NT)	UCF-8339-001		...	...	010	<b>85321</b>	...
		UCF-8339-002		...	...	010	<b>85321</b>	...

**GUÍA DE APLICACIONES – CAMIONES, TRÁILERS Y AUTOBUSES**

Año	Modelo	# E.O.	Delantero		Trasero	
						
			Fleetline	GasSLX	Fleetline	GasSLX

**FRUEHAUF (Cont.)**

	Todos con Eje Levantado	UCE-9399-1		...	...	010	<b>83122</b>	<b>89406</b>
	Todos con Suspensión de Aire y Número de E.O.	UCE-1295-1		...	...	010	<b>85300</b>	<b>89419</b>
	Modelos con Número de E.O.	144-5910		...	...	010	<b>85300</b>	<b>89419</b>
		680117		...	...	010	<b>85300</b>	<b>89419</b>
		680298		...	...	010	<b>85321</b>	...
		UCA-01113		...	...	010	<b>85304</b>	...
		UCA-5431		...	...	010	<b>85305</b>	...
		UCD-6216-1		...	...	010	<b>83203</b>	<b>89436</b>
		UCE-2983-1		...	...	010	<b>85322</b>	...
		UEY 1124-001		...	...	010	<b>85030</b>	<b>89440</b>

**FWD TRUCK**

	Modelos con Número de E.O.	450739	010	<b>85302</b>	<b>89420</b>		...	...
--	----------------------------	--------	-----	--------------	--------------	--	-----	-----





**GENERAL TRAILER CO**

	Modelos con Suspensión de Aire	120-1		...	...	010	<b>83125</b>	...
	Intercambios Adicionales de E.O.	12608	010	<b>83125</b>				

**GILLIG BROS.**

	Autobús Escolar con Pernos de Montaje de 1"	200-171	010	<b>85304</b>				
		53-176	010	<b>85304</b>				
	Autobús Escolar con Pernos de Montaje de 3/4"	57113	010	<b>83219</b>	...		...	...
		57131		...	...	010	<b>83216</b>	...
	Autobús Urbano, Phantom 55, 40, TB40	53-14010		...	...	-1-	<b>85318</b>	...
		53-24685	01-	<b>85723</b>	...		...	...
		695110		...	...	-1-	<b>85318</b>	...
		90F-1912		...	...	-1-	<b>85318</b>	...
	Modelos con Número de E.O.	90-1951-SP1		...	...	010	<b>85734</b>	...
		90-1968	010	<b>85712</b>	...		...	...
	Modelos con Suspensión de Aire Neway ARD-234 para Camión y Tracto (ARD-234-6)	90044046		...	...	010	<b>83123</b>	<b>89405</b>
	Modelos con Suspensión de Aire Neway con estampado en el amortiguador	90045084		...	...	010	<b>85968</b>	...
	Modelos Phantom (30 Pies) con Número de E.O.	90-2164 SP1	01-	<b>85723</b>	...		...	...
<b>00 - 11</b>	Modelos Phantom con Número de E.O.	90-2627		...	...	010	...	<b>89461</b>
	Modelos con Número de E.O.	1583470		...	...	010	<b>85051</b>	...
		695109	01-	<b>85723</b>	...		...	...
		82-01878	010	<b>83122 or 89406</b>				
		90044683		...	...	010	<b>83122</b>	<b>89406</b>
		90044769		...	...	010	<b>83207</b>	<b>89407</b>
		90044770		...	...	010	<b>83207</b>	<b>89407</b>
		90-2423	01-	<b>85723</b>	...		...	...
		H53-02132-14005	01-	<b>85723</b>	...		...	...
		H53-20415-006		...	...	010	<b>85051</b>	...
		MR6394	01-	<b>85723</b>	...		...	...
	Intercambios Adicionales de E.O.	53-02132	01-	<b>85723</b>				
		53-02133-000	-1-	<b>85318</b>				
		53-13952-000	-1-	<b>85722</b>				
		53-14005-000	01-	<b>85723</b>				
		665568	010	<b>85051</b>				
		680009	010	<b>85302 or 89420</b>				
		680333	-1-	<b>85708</b>				
		70034	010	<b>85302 or 89420</b>				
		82-21542-000	010	<b>85716</b>				
		82-30159-000	-1-	<b>85708</b>				
		90-1908	01-	<b>85723</b>				

**GUÍA DE APLICACIONES – CAMIONES, TRÁILERS Y AUTOBUSES**

Año	Modelo	# E.O.	Delantero		Trasero	
						
			Fleetline	GasSLX	Fleetline	GasSLX

**GMC TRUCK**

		1591501		...	...	- -	<b>85722</b>	...
--	--	---------	--	-----	-----	-----	--------------	-----

**Coaches**

	Modelos 4100, 4900	3182842	- 0			<b>85711</b>		
		3188599	- 0			<b>85711</b>		
		3192416	- 0			<b>85711</b>		
		4975552	- 0			<b>85711</b>		
	Modelos 4500, 5300	3166657	0 0			<b>85700</b>		
		3192333	0 0			<b>85700</b>		
	Modelos con Número de E.O.	3175509	0 0			<b>85735</b>		
		3178106	0 0			<b>85700</b>		
		3178507	0 0			<b>85700</b>		
		3178995	0 0			<b>85700</b>		
		3189265	0 0			<b>85700</b>		
		5304059	0 0			<b>85700</b>		
		5316784	0 0			<b>85700</b>		
		5316794	0 0			<b>85700</b>		
		5316984	0 0			<b>85313</b>		
		5352857	0 0			<b>85700</b>		
		5527271	0 0			<b>85700</b>		
		5527272	0 0			<b>85700</b>		
		5549924	0 0			<b>85700</b>		

**Series 3500 & 4000**

<b>63 - 66</b>	Autobús Escolar y Camión	.....	0 0	<b>85005</b>	<b>89430</b>	0 0	<b>83221</b>	...
<b>60 - 62</b>	Modelos 3500, 4000, B-4000, L-4000, S-4000 con Ejes H-130, H-150 y 13800	.....		...	...	0 0	<b>83221</b>	...





**Series 4500**

<b>66 - 72</b>	Cabina Convencional CE-4500, CS-4500 con Motor a Gasolina V-8 o En Línea de 6	22012096	0 0			<b>83221</b>		
		3192892	0 0			<b>83221</b>		
<b>66 - 72</b>	Cabina EG-4500, EM-4500, ES-4500 con Motor V-6 a Gas o Diesel, o Línea de 6 a Gas	22012095		...	...	0 0	<b>83126</b>	<b>89430</b>
		3171068	0 0	<b>83216</b>	...		...	...
		3171462		...	...	0 0	<b>83126</b>	<b>89430</b>
		3192657	0 0	<b>83216</b>	...		...	...
		3192890		...	...	0 0	<b>83126</b>	<b>89430</b>
		4940614	0 0	<b>83216</b>	...		...	...
		4963853	0 0	<b>83216</b>	...		...	...
<b>72 - 76</b>	PS4620 P, 4650P Step Van (Walk-in)	22007701	0 0	<b>83126</b>	<b>89430</b>		...	...
		3192890	0 0	<b>83126</b>	<b>89430</b>		...	...
		4940606	0 0	<b>83126</b>	<b>89430</b>		...	...
		4975497	0 0	<b>83126</b>	<b>89430</b>		...	...
<b>72 - 77</b>	PS4620 P, 4650P Step Van (Walk-in)	22012095	0 0	<b>83126</b>	<b>89430</b>		...	...
<b>72 - 80</b>	PS4620 P, 4650P Step Van (Walk-in)	22012096		...	...	0 0	<b>83221</b>	...
		3192892		...	...	0 0	<b>83221</b>	...
<b>77</b>	PS4620 P, 4650P Step Van (Walk-in)	22012166	0 0	<b>83126</b>	<b>89430</b>		...	...
		22012169	0 0	<b>83221</b>	...		...	...
<b>72 - 80</b>	PS4620 P, 4650P Step Van (Walk-in) - perno superior de 3/4"	22002293	0 0	<b>83126</b>	<b>89430</b>		...	...
<b>72 - 80</b>	PS4620 P, 4650P Step Van (Walk-in) - perno superior de 5/8"	22007751	0 0	<b>83303</b>	...		...	...

**Series 5000**

<b>60 - 62</b>	5000, B-5000, L-5000, S-5000 con Eje 1618 o 16802	.....		...	...	0 0	<b>83221</b>	...
<b>60 - 68</b>	Autobús Escolar Modelo SP-5000, DSP-5000	.....	0 0	<b>85302</b>	<b>89420</b>	0 0	<b>85307</b>	...
<b>63 - 66</b>	Autobús Escolar y Camión	.....	0 0	<b>85005</b>	<b>89430</b>		...	...
<b>75 - 80</b>	Chasis C - Cabina Convencional	4975510	0 0	<b>83221</b>	...		...	...
<b>76 - 89</b>	Chasis C - Cabina Convencional	22002294	0 0	<b>83304</b>	...		...	...
		22007752	0 0	<b>83304</b>	...		...	...

**GUÍA DE APLICACIONES – CAMIONES, TRÁILERS Y AUTOBUSES**

Año	Modelo	# E.O.	Delantero		Trasero	
						
			Fleetline	GasSLX	Fleetline	GasSLX

**GMC TRUCK (Cont.)**

**Series 5000 (Cont.)**

76 - 89	Chasis C - Cabina Convencional	22007757	010	83304	...		...	...
		22012096		...	...	010	83221	...
		22012196		...	...	010	83221	...
73 - 80	Chasis C, S - Cabina Convencional	22007750	010	83207	89407		...	...
		4975467	010	83207	89407		...	...
		4975494	010	83207	89407		...	...
73 - 80	Chasis C, S - Cabina Convencional y Autobús Escolar	22012096		...	...	010	83221	...
		3192892		...	...	010	83221	...
73 - 89	Chasis C, S - Cabina Convencional y Autobús Escolar	22012095		...	...	010	83126	89430
		22012166		...	...	010	83126	89430
63 - 68	Modelos W-5000, BW-5000, DW-5000	.....	010	85005	89430		...	...





**Series 5500**

67 - 68	Autobús Escolar y Camión	.....	010	85005	89430	010	83221	...
66 - 72	Cabina Convencional & Abatible CG-5500, CM-5500, T-5500 con Motores a Gasolina o Diesel V-6	22012095	010	83126	89430		...	...
		3192890	010	83126	89430		...	...
		4940606	010	83126	89430		...	...
66 - 72	Cabina Convencional CE-5500, CS-5500 con Motor a Gasolina V-8 o En Línea de 6	22012096	010	83221				
		3192891	010	83221				
		3192892	010	83221				
66 - 72	Cabina EG-5500, EM-5500, ES-5500 con Motor 6 Cilindros	22012095		...	...	010	83126	89430
		3171068	010	83216	...		...	...
		3171462		...	...	010	83126	89430
		3192657	010	83216	...		...	...
		3192890		...	...	010	83126	89430
		4940614	010	83216	...		...	...
		4963853	010	83216	...		...	...
4963854	010	83216	...		...	...		
60 - 68	LW-5500	.....	010	85307	...		...	...
63 - 68	Modelos W-5500	.....	010	85005	89430		...	...

**Series 6000**

79 - 89	Autobús Escolar - Chasis S	22002294	010	83304	...		...	...
		22007702	010	83304	...		...	...
		22007752	010	83304	...		...	...
		22007757	010	83304	...		...	...
76 - 89	Chasis C - Cabina Convencional	22002294	010	83304	...		...	...
		22007752	010	83304	...		...	...
		22007757	010	83304	...		...	...
75 - 80	Chasis C, S - Cabina Convencional y Autobús Escolar	4975510	010	83221	...		...	...
79 - 89	Chasis C, S - Cabina Convencional y Autobús Escolar	22002295	010	83303	...		...	...
		22007753	010	83303	...		...	...
		22017530	010	83303	...		...	...
		22017531	010	83303	...		...	...
73 - 75	Chasis C, S - Cabina Convencional y Autobús Escolar - Exc. Eje Trasero 18500, 20800 & 23000 lb	22007750	010	83207	89407		...	...
		4975467	010	83207	89407		...	...
		4975494	010	83207	89407		...	...
73 - 89	Chasis C, S - Cabina Convencional y Autobús Escolar - Exc. Eje Trasero 18500, 20800 & 23000 lb	22012096		...	...	010	83221	...
		22012169		...	...	010	83221	...
		3192892		...	...	010	83221	...
73 - 89	Chasis C, S - Cabina Convencional y Autobús Escolar con Eje Trasero 18500, 20800 & 23000 lb	22012095		...	...	010	83126	89430
		22012166		...	...	010	83126	89430
		4940606		...	...	010	83126	89430

**GUÍA DE APLICACIONES – CAMIONES, TRÁILERS Y AUTOBUSES**

Año	Modelo	# E.O.	Delantero		Trasero	
						
			Fleetline	GasSLX	Fleetline	GasSLX

**GMC TRUCK (Cont.)**





**Series 6000 (Cont.)**

73 - 80	Chasis C, S, T - Cabina Convencional & Abatible, y Autobús Escolar con Eje 5000 & 7000 lb	22002293	010	83126	89430		...	...
		22007701	010	83126	89430		...	...
		22007751	010	83303	...		...	...
		22012095	010	83126	89430		...	...
		3192890	010	83126	89430		...	...
		4940606	010	83126	89430		...	...
		4940662	010	83126	89430		...	...
		4975497	010	83126	89430		...	...
79 - 80	Chasis W - Cabina Abatible BBC de 72"	22002293	010	83126	89430		...	...
		22007751	010	83303	...		...	...
63 - 68	DW - 6000	.....	010	85005	89430		...	...
60 - 68	L - 6000	.....	010	85307	...		...	...

**Series 6500**

66 - 72	Cabina Convencional CE-6500, CM-6500 con Motor a Diesel V-6 o a Gasolina V-8	3192892		...	...	010	83221	...
66 - 72	Cabina Convencional CE-6500, ME-6500 con Motor a Gasolina V-8 - Exc. Eje de 11000 lb	22012096	010	83221	...		...	...
		3192891	010	83221	...		...	...
		3192892	010	83221	...		...	...
66 - 72	Cabina Convencional CE-6500, ME-6500 con Motor a Gasolina V-8 con Eje de 11000 lb	22012095	010	83126	89430		...	...
		3192890	010	83126	89430		...	...
		4940606	010	83126	89430		...	...
66 - 72	Cabina Convencional CM-6500, TE-6500, TM-6500 con Motor a Diesel V-6 o Gasolina V-8	22012095	010	83126	89430		...	...
		22012096		...	...	010	83221	...
		3192890	010	83126	89430		...	...
		4940606	010	83126	89430		...	...
66 - 72	Cabina EG-6500, DM-6500, ES-6500 con Motor V-6 a Gas o Diesel, o Línea de 6 a Gas	22012095		...	...	010	83126	89430
		3171068	010	83216	...		...	...
		3171462		...	...	010	83126	89430
		3192657	010	83216	...		...	...
		3192890		...	...	010	83126	89430
4963853	010	83216	...		...	...		
75 - 76	Chasis C, M - Cabina Convencional	4975510	010	83221	...		...	...
76 - 89	Chasis C, M - Cabina Convencional	22002294	010	83304	...		...	...
		22007752	010	83304	...		...	...
		22007757	010	83304	...		...	...
73 - 75	Chasis C, M - Cabina Convencional con Eje 9000 & 12000 lb	22012095	010	83126	89430		...	...
		3192890	010	83126	89430		...	...
		4940606	010	83126	89430		...	...
		4940614	010	83216	...		...	...
		4963854	010	83216	...		...	...
		4975497	010	83126	89430		...	...
75 - 89	Chasis C, M - Cabina Convencional con Eje 9000 & 12000 lb	22002295	010	83303	...		...	...
		22007751	010	83303	...		...	...
		22017530	010	83303	...		...	...
		22017531	010	83303	...		...	...
		4975511	010	83303	...		...	...
73 - 75	Chasis C, M, S - Cabina Convencional y Autobús Escolar	22007750	010	83207	89407		...	...
		4975467	010	83207	89407		...	...
		4975494	010	83207	89407		...	...
73 - 80	Chasis C, M, S - Cabina Convencional y Autobús Escolar - Exc. Eje Trasero 20800 o 23000 lb	22012096		...	...	010	83221	...
		22012169		...	...	010	83221	...

**GUÍA DE APLICACIONES – CAMIONES, TRÁILERS Y AUTOBUSES**

Año	Modelo	# E.O.	Delantero		Trasero	
						
			Fleetline	GasSLX	Fleetline	GasSLX

**GMC TRUCK (Cont.)**

**Series 6500 (Cont.)**

73 - 80	Chasis C, M, S - Cabina Convencional y Autobús Escolar - Exc. Eje Trasero 20800 o 23000 lb	3192892		...	...	010	83221	...
73 - 80	Chasis C, M, S - Cabina Convencional y Autobús Escolar con Eje Trasero 20800 o 23000 lb	22012095		...	...	010	83126	89430
		22012166		...	...	010	83126	89430
		4940606		...	...	010	83126	89430
73 - 80	Chasis C, S, T - Cabina Convencional & Abatible, y Autobús Escolar	22002293	010	83126	89430		...	...
		22012095	010	83126	89430		...	...
		3192890	010	83126	89430		...	...
		4940606	010	83126	89430		...	...
		4975497	010	83126	89430		...	...



**Series 7000**

79 - 89	Chasis C, M - Cabina Convencional BBC de 97"	22002294	010	83304	...		...	...
		22002295	010	83303	...		...	...
		22007752	010	83304	...		...	...
		22007753	010	83303	...		...	...
		22007757	010	83304	...		...	...
		22017530	010	83303	...		...	...
		22017531	010	83303	...		...	...
79 - 81	Chasis C, M - Cabina Convencional BBC de 97" - Exc. Eje Trasero 18500, 20800 & 23000 lb	22012096		...	...	010	83221	...
		2212169		...	...	010	83221	...
79 - 89	Chasis C, M - Cabina Convencional BBC de 97" con Eje Trasero 18500, 20800 & 23000 lb	22012095		...	...	010	83126	89430
		22012166		...	...	010	83126	89430
79 - 80	Chasis W - Cabina Abatible BBC de 72"	22002293	010	83126	89430		...	...
		22007751	010	83303	...		...	...

**Series 7500**

66 - 69	Cabina Abatible BBC de 72"	22012095	010	83126	89430		...	...
		3171462	010	83126	89430		...	...
		4940606	010	83126	89430		...	...
70 - 72	Cabina Abatible BBC de 72" con Frenos de Aire - Exc. Motor de Gasolina	22012095	010	83126	89430		...	...
		3171462	010	83126	89430		...	...
		4940606	010	83126	89430		...	...
70 - 72	Cabina Abatible BBC de 72" con Frenos de Aire & Motor de Gasolina	22012091	010	85303	89422		...	...
		5552452	010	85303	89422		...	...
66 - 72	Cabina Abatible BBC de 72" con Motor de Ciclo Diesel V-6 2 con Eje 17221	22012096		...	...	010	83221	...
		3192892		...	...	010	83221	...
66 - 72	Cabina Abatible BBC de 72" con Motor de Ciclo Diesel V-6 2 con Eje 19101 y 19201	4940600		...	...	010	83209	89414
66 - 72	Cabina Convencional BBC de 92" con Muelles Sofride de 2 Hojas con Rating de 11000 lb y Eje F120 (12000 lb)	22046483	010	85304	...		...	...
		22052336	010	85304	...		...	...
		3171069	010	85304	...		...	...
66 - 72	Cabina Convencional BBC de 92" con Muelles Sofride de 2 Hojas con Rating de 7000 & 9000 lb y Eje F070, F090, F120 (7000, 9000 & 12000 lb)	3171068	010	83216	...		...	...
		3192657	010	83216	...		...	...
		4940614	010	83216	...		...	...
		4963853	010	83216	...		...	...
		4963854	010	83216	...		...	...
77 - 80	Chasis H, J - Cabina Convencional BBC de 92"	4963854	010	83216	...		...	...
		4984526	010	83216	...		...	...
73 - 80	Chasis H, J - Cabina Convencional BBC de 92" & 114"	22046483	010	85304	...		...	...
		22052336	010	85304	...		...	...

**GUÍA DE APLICACIONES – CAMIONES, TRÁILERS Y AUTOBUSES**

Año	Modelo	# E.O.	Delantero		Trasero	
						
			Fleetline	GasSLX	Fleetline	GasSLX

**GMC TRUCK (Cont.)**

**Series 7500 (Cont.)**

73 - 80	Chasis H, J - Cabina Convencional BBC de 92" & 114"	3171069	010	85304	...		...	...
73 - 80	Chasis H, J - Cabina Convencional BBC de 92" & 114" con V-6, V-8 a Gas o V-6 a Diesel	4940614	010	83216	...		...	...
		4963854	010	83216	...		...	...
73 - 80	Chasis R - Autobús con Motor Atrás	22012090	010	85308	89422		...	...
		22012091		...	...	010	85303	89422
		5552451	010	85308	89422		...	...
		5552452		...	...	010	85303	89422
		5552456		...	...	010	85307	...
73 - 80	Chasis T, W - Cabina Abatible BBC de 72" con Motor V-6 a Diesel	22007751	010	83303	...		...	...
		22012095	010	83126	89430		...	...
		4940606	010	83126	89430		...	...
		4975497	010	83126	89430		...	...
73 - 80	Chasis T, W - Cabina Abatible BBC de 72" con Motor V-6 a Gas	22012091	010	85303	89422		...	...
		5552452	010	85303	89422		...	...

**Series 8500**





66 - 72	Cabina Abatible BBC de 72"	5544060	010	85302	89420		...	...
67	Cabina Convencional BBC de 92"	3171068	010	83216	...		...	...
		3192657	010	83216	...		...	...
		4940614	010	83216	...		...	...
		4963853	010	83216	...		...	...
		4963854	010	83216	...		...	...
66 - 72	Cabina Convencional BBC de 92" con Ejes de 7000 & 9000 lb	22046483	010	85304	...		...	...
		22052336	010	85304	...		...	...
		3171069	010	85304	...		...	...
79 - 80	Chasis D, F - Cabina de Aluminio Abatible BBC de 54"	22046483	010	85304	...		...	...
		22052336	010	85304	...		...	...
		3171069	010	85304	...		...	...
73 - 86	Chasis H, J - Cabina Convencional BBC de 92" & 114"	22046483	010	85304	...		...	...
		22052336	010	85304	...		...	...
		3171069	010	85304	...		...	...
79 - 82	Chasis H, J - Cabina Convencional BBC de 92" 4 x 2 con Suspensión de Aire	22012065		...	...	010	85304	...
		22046483		...	...	010	85304	...
		22052336		...	...	010	85304	...
		3171069		...	...	010	85304	...
73 - 81	Chasis H, J - Cabina Convencional BBC de 92" con Motores V-6, V8 a Gas	4940614	010	83216	...		...	...
		4963854	010	83216	...		...	...
		4984526	010	83216	...		...	...
73 - 80	Chasis R - Autobús con Motor Atrás	22012090	010	85308	89422		...	...
		22012091		...	...	010	85303	89422
		5552451	010	85308	89422		...	...
		5552452		...	...	010	85303	89422
		5552456		...	...	010	85307	...
73 - 80	Chasis T, W - Cabina Abatible BBC de 72" con Motor V-6 a Gas	22012091	010	85303	89422		...	...
		5552452	010	85303	89422		...	...

**Series 9500**

66 - 72	Cabina Abatible BBC Aluminio de 48"	5552454	010	85302	89420		...	...
72	Cabina Convencional BBC 114" con Motor V-8 71	4940614	010	83216	...		...	...
		4963854	010	83216	...		...	...
67 - 72	Cabina Convencional BBC de 92" & 114"	3171068	010	83216	...		...	...
		3192657	010	83216	...		...	...
		4940614	010	83216	...		...	...



## GUÍA DE APLICACIONES – CAMIONES, TRÁILERS Y AUTOBUSES

Año	Modelo	# E.O.	Delantero		Trasero	
			 Fleetline	 GasSLX	 Fleetline	 GasSLX

### GMC TRUCK (Cont.)

#### Series 9500 (Cont.)

67 - 72	Cabina Convencional BBC de 92" & 114"	4963853	010	83216	...		...	...
		4963854	010	83216	...		...	...
66 - 72	Cabina Metálica Abatible BBC de 72"	22012091	010	85303	89422		...	...
		5552452	010	85303	89422		...	...
73 - 89	Chasis D, F - Cabina de Aluminio Abatible BBC de 54" con Suspensión de Aire Trasera GM (4 Piezas)	22012065		...	...	010	85304	...
		22046483		...	...	010	85304	...
		22052336		...	...	010	85304	...
		3171069		...	...	010	85304	...
73 - 89	Chasis D, F - Cabina de Aluminio BBC de 54"	22012065	010	85304	...		...	...
		22046483	010	85304	...		...	...
		22052336	010	85304	...		...	...
		3171069	010	85304	...		...	...
73 - 89	Chasis H, J - Cabina Convencional BBC de 92"	22046483	010	85304	...		...	...
		22052336	010	85304	...		...	...
		3171069	010	85304	...		...	...
73 - 89	Chasis H, J - Cabina Convencional BBC de 92" con Suspensión Trasera GM Air-Ride (4 amortiguadores)	22012065		...	...	010	85304	...
		22046483		...	...	010	85304	...
		22052336		...	...	010	85304	...
		3171069		...	...	010	85304	...
77 - 89	Chasis M, N - Cabina Convencional BBC de 114" & BBC de Aluminio de 108"	22046483	010	85304	...		...	...
		22052336	010	85304	...		...	...
		3171069	010	85304	...		...	...
77 - 89	Chasis M, N - Cabina Convencional BBC de 114" & BBC de Aluminio de 108" con Suspensión Trasera GM Air-Ride (4 amortiguadores)	22046483		...	...	010	85304	...
		22052336		...	...	010	85304	...
		3171069		...	...	010	85304	...
73 - 80	Chasis T, W - Cabina Abatible BBC de 72"	22012091	010	85303	89422		...	...
		5552452	010	85303	89422		...	...
66 - 72	Modelos con Número de E.O.	22046483	010	85304	...		...	...
		22052336	010	85304	...		...	...
		3171069	010	85304	...		...	...





#### Series B - Autobús Escolar

90 - 98	Chasis Autobús Escolar Modelo B7 con Muelles 11000, 13500, 15000 lb	22064231		...	...	- -	85324	...
90 - 06	Chasis Autobús Escolar Modelo B7 con Muelles 15000, 19000, 21000 lb	15174902		...	...	- -	85071	...
		22064232		...	...	- -	85071	...
- 09	Modelos B6 , B7 con Número de E.O.	15123676	- -	83136	...		...	...
		15588554	- -	83136	...		...	...
		22064230	- -	83136	...		...	...
		88982682	- -	83136	...		...	...

#### Series C - (C4500, C5500) Topkick

04 - 09	Chasis C - Cabina Convencional (Sin Opción 4x4) con Muelles Multihojas de 13,500 lb	15185644		...	...	010	83155	...
		508-89		...	...	010	83155	...
		L-12706		...	...	010	83155	...
90 - 09	Chasis C - Cabina Convencional con Amortiguador Delantero con Número de E.O.	15123676	- -	83136	...		...	...
		15588554	- -	83136	...		...	...
		15887728	- -	83136	...		...	...
		19152843	- -	83136	...		...	...
		22064230	- -	83136	...		...	...
		88982682	- -	83136	...		...	...

**GUÍA DE APLICACIONES – CAMIONES, TRÁILERS Y AUTOBUSES**

Año	Modelo	# E.O.	Delantero		Trasero	
						
			Fleetline	GasSLX	Fleetline	GasSLX

**GMC TRUCK (Cont.)**

**Series C - (C4500, C5500) Topkick (Cont.)**

83 - 99	Chasis C - Cabina Convencional con Eje Trasero 9100 a 17500 lb	22064432		...	...	010	85050	...
90 -	Chasis C - Cabina Convencional con Muelles de 11000, 13500, 15000 lb	22064231		...	...	-1-	85324	...
90 -	Chasis C - Cabina Convencional con Muelles de 19000, 21000, 23000 lb (Exc. Vehículos Perfil Bajo)	22064233		...	...	-1-	83136	...
90 - 09	Chasis C - Cabina Convencional con Muelles Multihojas de 15000, 19000, 21000 lb	15174902		...	...	-1-	85071	...
		22064232		...	...	-1-	85071	...
		88982686		...	...	-1-	85071	...
90 - 06	Chasis C - Cabina Convencional con Muelles Multihojas de 16900 o 17850 lb	21998392		...	...	-1-	85336	...
		22064489		...	...	-1-	85336	...
		88963409		...	...	-1-	85336	...
03 - 09	Chasis C - Cabina Convencional con Suspensión Trasera de Muelles	15185643		...	...	010	83153	...
	Modelos con Número de E.O.	88982684	-1-	83136	...		...	...
		88982686		...	...	-1-	85071	...
		88982688		...	...	-1-	85336	...

**Series C - (C6500, C7500, C8500) Topkick**

90 - 09	Cabina Convencional Amortiguador Delantero con Número de E.O.  con Muelles Multihojas de 15000, 19000, 21000 lb	15123676	-1-	83136	...		...	...
		15174898	-1-	83136	...		...	...
		15588554	-1-	83136	...		...	...
		15887728	-1-	83136	...		...	...
		19152843	-1-	83136	...		...	...
		22064230	-1-	83136	...		...	...
		88982682	-1-	83136	...		...	...
		15174902		...	...	-1-	85071	...
		22064232		...	...	-1-	85071	...
		88982686		...	...	-1-	85071	...
04 - 08	Cabina Convencional (Perfil Bajo) con Muelles de 12000, 15000, & 17000 lb	15174901		...	...	-1-	85342	...
		507-22		...	...	-1-	85342	...
		88982685		...	...	-1-	85342	...
90 -	Cabina Convencional c/ Muelles de 19000, 21000, 23000 lb (Exc. Perfil Bajo)	22064233		...	...	-1-	83136	...
83 - 99	Cabina Convencional con Eje Trasero de 9100 lb a 17500 lb	22064432		...	...	010	85050	...
90 -	Cabina Convencional con Muelles de 11000, 13500, 15000 lb	22064231		...	...	-1-	85324	...
90 - 06	Cabina Convencional con Muelles de 16900 o 17850 lb	21998392		...	...	-1-	85336	...
		22064489		...	...	-1-	85336	...
		88963409		...	...	-1-	85336	...
04 - 08	Cabina Convencional con Muelles de 19000 lb	15174903		...	...	-1-	85342	...
		507-23		...	...	-1-	85342	...
		88982687		...	...	-1-	85342	...
95 - 99	Modelos con Suspensión de Aire Hendrickson (No. de Estampado 47902-13)	12474915		...	...	010	83122	89406
		15963161		...	...	010	83122	89406
96 - 99	Modelos con Suspensión de Aire Hendrickson (No. de Estampado 47902-29)	12474917		...	...	010	83121	...
		15740554		...	...	010	83121	...
	Modelos con Número de E.O.	88982684	-1-	83136	...		...	...
		88982688		...	...	-1-	85336	...

**Series P**

92 - 96	Chasis Motorhome	22064231		...	...	-1-	85324	...
		22064233		...	...	-1-	83136	...

## GUÍA DE APLICACIONES – CAMIONES, TRÁILERS Y AUTOBUSES

Año	Modelo	# E.O.	Delantero		Trasero	
			Fleetline	GasSLX	Fleetline	GasSLX

### GMC TRUCK (Cont.)





#### Series T (T5500, T6500, T7500, T8500) (Cont.)

90 - 06	Cabina Abatible con Muelles Multihojas de 15000, 19000, 21000 lb	15174902		...	...	- -	<b>85071</b>	...
		22064232		...	...	- -	<b>85071</b>	...
90 - 99	Cabina Abatible con Muelles Taperleaf 11000, 13500, 15000 lb	22064231		...	...	- -	<b>85324</b>	...
92 - 99	Cabina Abatible con Muelles Taperleaf de 19000, 21000, 23000 lb (Exc. Perfil Bajo)	22064233		...	...	- -	<b>83136</b>	...
92 - 06	Cabina Abatible con Muelles Taperleaf RR SUSP(GZH) Heavy Duty de 16900 lb	21998392		...	...	- -	<b>85336</b>	...
		22064489		...	...	- -	<b>85336</b>	...
		88963409		...	...	- -	<b>85336</b>	...
97 -	Cabina Abatible FL1 con Eje de 8100 lb	22064804	- -	<b>83136</b>	...		...	...
		22064805	- -	<b>83136</b>	...		...	...
		22165187	- -	<b>83136</b>	...		...	...
		22165188	- -	<b>83136</b>	...		...	...
97 -	Cabina Abatible FL2 con Eje de 5000 a 11000 lb	22064807	- -	<b>83136</b>	...		...	...
		22166442	- -	<b>83136</b>	...		...	...
97 -	Cabina Abatible FL3 con Eje de 14575 lb	22064806	- -	<b>83136</b>	...		...	...
		22165189	- -	<b>83136</b>	...		...	...
99	Modelos con Suspensión de Aire Hendrickson (No. de Estampado 47902-13)	12474915		...	...	0 0	<b>83122</b>	<b>89406</b>
		15963161		...	...	0 0	<b>83122</b>	<b>89406</b>
06 - 09	Modelos de Cabina Abatible con Número de E.O.	15174901		...	...	- -	<b>85342</b>	...
		15174903		...	...	- -	<b>85342</b>	...
		507-22		...	...	- -	<b>85342</b>	...
		507-23		...	...	- -	<b>85342</b>	...
		88982685		...	...	- -	<b>85342</b>	...
		88982687		...	...	- -	<b>85342</b>	...

#### Series W (Isuzu)

89 - 90	Flatflow Modelos W4	9-51630-647-1	- 0	<b>G63616</b>	...		...	...
89 - 92	Flatflow Modelos W4	8-51630-666-0		...	...	0 0	<b>85012</b>	<b>89413</b>
	Modelos con Número de E.O.	8-97253664-0		...	...	0 0	<b>83159</b>	...
		97253664		...	...	0 0	<b>83159</b>	...
83 - 95	Modelos W4	8-51630-666-0		...	...	0 0	<b>85012</b>	<b>89413</b>
		9-51630-666-0		...	...	0 0	<b>85012</b>	<b>89413</b>
86 - 90	Modelos W4	8-94454-986-0	- 0	<b>G63616</b>	...		...	...
		8-94454-987-0	- 0	<b>G63616</b>	...		...	...
		9-51630-647-1	- 0	<b>G63616</b>	...		...	...
01 - 08	Modelos W4 con Número de E.O.	97253651		...	...	0 0	<b>83404</b>	...
02 - 09	Modelos W4 con Número de E.O.	8-97253665-0		...	...	0 0	<b>83159</b>	...
		898098-0580		...	...	0 0	<b>83159</b>	...
		898098-0590		...	...	0 0	<b>83159</b>	...
		97253665		...	...	0 0	<b>83159</b>	...
02 - 10	Modelos W4 con Número de E.O.	98098058		...	...	0 0	<b>83159</b>	...
		98098059		...	...	0 0	<b>83159</b>	...
86 - 95	Modelos W4 con Suspensión de 11000 lb	97083027	- 0	<b>G63616</b>	...		...	...
03 - 09	Modelos W4 con Suspensión de 11000 lb y 13000 lb	97253620	- 0	<b>83515</b>	...		...	...
87 - 96	Modelos W4 con Suspensión de 13000 lb	94454987	- 0	<b>G63616</b>	...		...	...
		97083029	- 0	<b>G63616</b>	...		...	...
88 - 99	Modelos W5	1-51630-217-0	- 0	<b>83114</b>	...		...	...
		1-51630-217-1	- 0	<b>83114</b>	...		...	...
		1-51630-219-1	- 0	<b>83114</b>	...		...	...
03 - 09	Modelos W5 con Número de E.O.	97253665		...	...	0 0	<b>83159</b>	...
03 - 09	Modelos W5 con Suspensión de 11000 lb y 13000 lb	97253620	- 0	<b>83515</b>	...		...	...
86 - 91	Modelos W6	1-51630-168-1	- 0	<b>G63610</b>	...		...	...
		1-51630-217-1	- 0	<b>83114</b>	...		...	...
	Modelos con Número de E.O.	8-94057-593-0	- 0	<b>83114</b>	...		...	...

**GUÍA DE APLICACIONES – CAMIONES, TRÁILERS Y AUTOBUSES**

Año	Modelo	# E.O.	Delantero		Trasero	
						
			Fleetline	GasSLX	Fleetline	GasSLX

**GMC TRUCK (Cont.)**

**Series W (Isuzu) (Cont.)**

Modelos con Número de E.O.	8-97083-029-0	-10	<b>G63616</b>	...		...	...
	8-97201-960-0	-10	<b>G63616</b>	...		...	...
	898098-1250	-10	<b>83515</b>	...		...	...
	898098-1250	-10	<b>83515</b>	...		...	...
	898098-1270	-10	<b>83515</b>	...		...	...
	90044769		...	...	010	<b>83207</b>	<b>89407</b>
	90044770		...	...	010	<b>83207</b>	<b>89407</b>
	94033786		...	...	-10	<b>83114</b>	...
	94051090	-10	<b>83114</b>	...		...	...
	94057593	-10	<b>83114</b>	...		...	...
	94454987	-10	<b>G63616</b>	...		...	...
	9-51630-666-2		...	...	010	<b>85012</b>	<b>89413</b>
	97083027	-10	<b>G63616</b>	...		...	...
	97083029	-10	<b>G63616</b>	...		...	...
	97201960	-10	<b>G63616</b>	...		...	...
	97253616	-10	<b>83515</b>	...		...	...
	97253621	-10	<b>83515</b>	...		...	...
	97253623	-10	<b>83515</b>	...		...	...
	98098125	-10	<b>83515</b>	...		...	...
	98098127	-10	<b>83515</b>	...		...	...

**Series WCA & WIA**

Modelos con Número de E.O.	37301-0016	01-	<b>85026</b>	<b>89417</b>		...	...
	37301-0021	01-	<b>85026</b>	<b>89417</b>		...	...
	37301-3202	01-	<b>85026</b>	<b>89417</b>		...	...

**Series WH**

Modelos WHS, WHR, WHL o WHE con Amortiguadores Delanteros Duales	3082284	-1-	<b>83400</b>	...		...	...
--	---------	-----	--------------	-----	--	-----	-----





**Aplicaciones Adicionales**

Modelos 1500							
Modelos con Suspensión Trasera	35901-0005		...	...	010	<b>83219</b>	...
Modelos con Número de E.O.	35901-0001		...	...	010	<b>83209</b>	<b>89414</b>

**Intercambios Adicionales de E.O.**

Modelos con Número de E.O.	15642943		...	...	-1-	<b>83136</b>	...
	22024061		...	...	010	<b>85704</b>	...
	22025067		...	...	010	<b>85704</b>	...
	22025305		...	...	010	<b>85704</b>	...
	22046489	010	<b>85303</b>	<b>89422</b>		...	...
	22065218	010	<b>G63347</b>	...		...	...
	22065251	010	<b>85030</b>	<b>89440</b>		...	...
	22099889		...	...	-1-	<b>85336</b>	...
	507-24		...	...	-1-	<b>85336</b>	...
	508-88		...	...	010	<b>83153</b>	...
	87-2520-00003		...	...	010	<b>85704</b>	...
	U0109-014		...	...	-1-	<b>83400</b>	...
	Intercambios Adicionales de E.O.	22007703	010				<b>83303</b>
22012067		010				<b>85700</b>	
22012079		-1-				<b>85701</b>	
22012082		010				<b>85702</b>	
22012083		-10				<b>85711</b>	
22012083GS		-10				<b>85711</b>	
22012090		010				<b>85308 or 89422</b>	
22012091		010				<b>85303 or 89422</b>	
22012114		010				<b>85700</b>	
22012131		-10				<b>85711</b>	
22017530		010				<b>83303</b>	

**GUÍA DE APLICACIONES – CAMIONES, TRÁILERS Y AUTOBUSES**





Año	Modelo	# E.O.	Delantero		Trasero	
						
			Fleetline	GasSLX	Fleetline	GasSLX

**GMC TRUCK (Cont.)**

**Intercambios Adicionales de E.O. (Cont.)**

Intercambios Adicionales de E.O.	22024062	-I-	85701
	22024673	-I0	85710
	22045526	0I0	85702
	22046481	0I0	85702
	22046485	-I0	85710
	22046499	-I0	85710
	22052014	0I0	85702
	22052424	-I0	85710
	3171696	0I0	85307
	3172948	0I0	85303 or 89422
	3175509	0I0	85735
	3178157	0I0	85700
	3178233	0I0	85734
	3178507	0I0	85700
	3178995	0I0	85700
	3188626	0I0	85300 or 89419
	3188729	0I0	85303 or 89422
	35901-0003	0I0	85301
	35901-0004	0I0	83219
	35901-0017	0I0	83314
	4939852	0I0	85308 or 89422
	4939967	0I0	85308 or 89422
	4940601	0I0	83216
	4940627	0I0	83203 or 89436
	4940640	0I0	83216
	4940650	0I0	83207 or 89407
	4940654	0I0	83216
	4940660	0I0	83207 or 89407
	4963844	0I0	85307
	4964853	0I0	83217
	4974401	0I0	85700
	4975429	0I0	85300 or 89419
	4975472	-I0	83161
	4975479	-I-	83400
	4975480	-I-	83400
	4975501	0I0	85700
	4975515	-I-	85701
	4975516	0I0	85702
	4975518	0I0	85704
	4975538	0I0	85700
	4975549	0I0	83216
	4975550	0I0	85702
	507-12	-I-	85701
	507-16	0I0	85702
	507-19	0I0	85700
5171068	0I0	83216	
5316791	0I0	83219	
5316792	0I0	85305	
5316793	0I0	85305	
5321920	0I0	85307	
5321929	0I0	85307	
5348631	0I0	83203 or 89436	
5352858	0I0	85305	
5353054	0I0	85303 or 89422	
5355798	0I0	85307	

**GUÍA DE APLICACIONES – CAMIONES, TRÁILERS Y AUTOBUSES**

Año	Modelo	# E.O.	Delantero		Trasero	
						
			Fleetline	GasSLX	Fleetline	GasSLX

**GMC TRUCK (Cont.)**

**Intercambios Adicionales de E.O. (Cont.)**

Intercambios Adicionales de E.O.	5357955	010	85300 or 89419
	5357956	010	85734
	5357959	010	85300 or 89419
	5361994	010	85734
	5374779	010	85308 or 89422
	5374999	010	85307
	5385939	010	85307
	5392387	010	85303 or 89422
	5394448	010	85305
	5394467	010	85305
	5394468	010	85735
	5455798	010	85307
	5513489	010	83216
	5513716	010	85304
	5516459	010	85305
	5522781	010	85735
	5522794	010	85308 or 89422
	5522818	010	85305
	5527001	010	85300 or 89419
	5527606	010	85305
	5531027	010	85301
	5531435	010	85307
	5531436	010	85307
	5531437	010	85307
	5532026	010	85304
	5532425	010	83207 or 89407
	5532433	010	83207 or 89407
	5532675	010	85307
	5533699	010	85302 or 89420
	5534430	010	85303 or 89422
	5534439	010	85304
	5534447	010	85303 or 89422
	5544112	010	83216
	5544581	010	85302 or 89420
	5544716	010	85304
	5544717	010	85304
	5544812	010	83308
	5544818	010	85735
	5549899	010	83207 or 89407
	5549925	010	85304
	5552111	010	85304
	5552112	010	85307
	5552114	010	83216
	5552205	010	83217
	5552206	010	83214
5552207	010	83217	
5552208	010	83217	
5552209	010	83215	
5552210	010	85308 or 89422	
5552244	010	85308 or 89422	
5552285	010	83214	
5552286	010	83217	
5552287	010	83217	
5552288	010	83217	
5552453	010	85301	

## GUÍA DE APLICACIONES – CAMIONES, TRÁILERS Y AUTOBUSES

Año	Modelo	# E.O.	Delantero		Trasero	
			Fleetline	GasSLX	Fleetline	GasSLX

### GMC TRUCK (Cont.)

#### Intercambios Adicionales de E.O. (Cont.)

	Intercambios Adicionales de E.O.	5552527	010	85735
		5554184	010	85302 or 89420
		5554589	010	85307
		5554596	010	85303 or 89422
		5554814	010	85302 or 89420
		5554959	010	83401
		5554995	010	85305
		5559363	010	83203 or 89436
		5585939	010	85307
		684280	010	83209 or 89414
		97-2210-00153	-1-	85701
		97-2210-00156	010	85702
		97-2210-00164	-1-	85708
		97-2210-00170	01-	85733
		98018780	010	83508
		98093668	010	83508
		98197653	010	83179

### GMC TRUCK AMORTIGUADORES DE CABINA

	Cabina Abatible Astro (Camiones con y sin Dormitorio) con Modelo Link Cabmate GMC-2P-A	1202-0032	010	83016
90 -	Cabinas de Camiones TopKick con Modelo Link Cabmate GMC104TK	1202-0054	010	83021
- 89	Cabinas de Camiones TopKick con Modelo Link Cabmate GMC92TK	1202-0012	010	83023
79 -	Camiones Convencionales BBC 108" o 116" con Link Cabmate Modelo GMC816	1202-0012	010	83023
03 -	Modelos C4500, C5500 con Link Cabmate Modelos GMT560	1201-1043	010	83025
		1202-1043	010	83025
	Modelos con Suspensión Link Cab	1202-0022	010	83046
	Tractos Brigadier con Cabinas J9 con Modelo Link Cabmate GMC92J9	1202-0012	010	83023

### GRANNING SUSPENSION

	Modelos T950-1200, -1400, -1700	2697		...	...	010	85712	...
	Modelos con Número de E.O.	1085		...	...	010	83214	...
		680162		...	...	010	85300	89419
		OE12425		...	...	010	83214	...

### GREAT DANE TRAILER

Es necesaria la identificación de la suspensión para determinar qué sección del catálogo referir. Posibles opciones pueden ser Chalmers, Hendrickson, Neway, Ridewell, Reyco.									
	Suspensión Reyco 87	18163-01		...	...	010	83207	89407	
	Suspensión Reyco 88	18164-01		...	...	010	83122	89406	
	Tráilers con número de parte Great Dane	HENS-20001		...	...	010	83128	89436	
		HENS-20002		...	...	010	85000	89436	
		HENS-20126		...	...	010	85323	89436	
		HENS-21292		...	...	010	85052	...	
		HENS-23566		...	...	010	85000	89436	
		HENS-23649		...	...	010	85064	...	
		HENS-24088		...	...	010	85000	89436	
		MER202447		...	...	010	85919	...	
		REY18165-01		...	...	010	85006	...	
	Tráilers con Suspensión de Aire Slider Reyco 86 AR / RS 1015, 1035, 3035	18165-01		...	...	010	85006	...	

## GUÍA DE APLICACIONES – CAMIONES, TRÁILERS Y AUTOBUSES

Año	Modelo	# E.O.	Delantero		Trasero	
			Fleetline	GasSLX	Fleetline	GasSLX

### GREYHOUND BUS

Modelo	# E.O.	Aplicación	Código
City Cruiser	12TA-01-013	010	<b>85303 or 89422</b>
MC5, MC7, MC8	12B-5-1	010	<b>85735</b>
	3178157	010	<b>85700</b>
Intercambios Adicionales de E.O.	3166657	010	<b>85700</b>
	3178154	010	<b>85735</b>
	3192333	010	<b>85700</b>
	690029	010	<b>85700</b>
	74413	010	<b>85313</b>

### GRUMMAN BUS

Modelo	# E.O.	Aplicación	Código
Autobús Modelo 870 Flex	22024506	-10	<b>85703</b> ...
	22025066	-10	<b>85703</b> ...
	22025067		... 010 <b>85704</b> ...
	22025305		... 010 <b>85704</b> ...
	97-2201-00001	-10	<b>85703</b> ...
	97-2201-00002	-10	<b>85703</b> ...
	97-2201-00003	-10	<b>85703</b> ...
	97-2201-00004	-10	<b>85703</b> ...
	97-2201-00005	-10	<b>85703</b> ...
	97-2210-00001		... 010 <b>85704</b> ...
	97-2210-00002		... 010 <b>85704</b> ...
	97-2210-00003		... 010 <b>85704</b> ...
	97-2210-00004		... 010 <b>85704</b> ...
	97-2210-00005		... 010 <b>85704</b> ...
	Intercambios Adicionales de E.O.	690029	010





### GULF STREAM COACH

#### MotorHomes Clase A

Código	Modelo	# E.O.	Aplicación	Código	
<b>02 - 06</b>	MotorHomes Friendship & Scenic Cruiser con Chasis Freightliner XC Amortiguador Trasero con Número de E.O.	141700131809		... 010 <b>85029</b> ...	
		16-16736-000		... 010 <b>85029</b> ...	
	Suspensión Delantera AS120	141700131810	010	<b>83160</b> ...	
		16-16737-000	010	<b>83160</b> ...	
	Suspensión Delantera ZF - IFS con PBV de 23,000 lb o mayor	16-16874-000	010	<b>83160</b> ...	
		16-18103-000	-1-	<b>85900</b> ...	
	Suspensión Trasera ADL200 de 20K	481700000493	-1-	<b>85900</b> ...	
		16-16873-000		... 010 <b>85029</b> ...	
	<b>03 - 06</b>	MotorHomes Series Atrium con Chasis Freightliner XC Amortiguador Trasero con Número de E.O.	141700131809		... 010 <b>85029</b> ...
			16-16736-000		... 010 <b>85029</b> ...
Suspensión Delantera AS120		141700131810	010	<b>83160</b> ...	
		16-16737-000	010	<b>83160</b> ...	
Suspensión Delantera ZF - IFS con PBV de 23,000 lb o mayor		16-16874-000	010	<b>83160</b> ...	
		16-18103-000	-1-	<b>85900</b> ...	
Suspensión Trasera ADL200 de 20K		481700000493	-1-	<b>85900</b> ...	
		16-16873-000		... 010 <b>85029</b> ...	
<b>02</b>		MotorHomes Series Independence con Chasis Freightliner XC Amortiguador Trasero con Número de E.O.	141700131809		... 010 <b>85029</b> ...
			16-16736-000		... 010 <b>85029</b> ...
	Suspensión Delantera AS120	141700131810	010	<b>83160</b> ...	
		16-16737-000	010	<b>83160</b> ...	
	Suspensión Delantera ZF - IFS con PBV de 23,000 lb o mayor	16-16874-000	010	<b>83160</b> ...	
		16-18103-000	-1-	<b>85900</b> ...	



## GUÍA DE APLICACIONES – CAMIONES, TRÁILERS Y AUTOBUSES

Año	Modelo	# E.O.	Delantero		Trasero	
						
			Fleetline	GasSLX	Fleetline	GasSLX

### GULF STREAM COACH (Cont.)

#### MotorHomes Clase A (Cont.)

02	Amortiguador Trasero con Número de E.O.	48170000493	- -	85900	...	...	...	...
	Suspensión Trasera ADL200 de 20K	16-16873-000		...	...	0 0	85029	...
02 - 04	MotorHomes Series Yellowstone con Chasis Freightliner XC							
	Amortiguador Trasero con Número de E.O.	141700131809		...	...	0 0	85029	...
		16-16736-000		...	...	0 0	85029	...
	Suspensión Delantera AS120	141700131810	0 0	83160	...		...	...
		16-16737-000	0 0	83160	...		...	...
		16-16874-000	0 0	83160	...		...	...
	Suspensión Delantera ZF - IFS con PBV de 23,000 lb o mayor	16-18103-000	- -	85900	...		...	...
	48170000493	- -	85900	...		...	...	
	Suspensión Trasera ADL200 de 20K	16-16873-000		...	...	0 0	85029	...

### HARDEE MFG

Modelos con Número de E.O.	8030223	...	...	0 0	83207	89407
	AS789B		...	...	0 0	85014

### HAUSMAN



Modelos con Número de E.O.	695110	...	...	- -	85318	...
	695119		...	...	0 0	85702
	695198		...	...	- -	85706

### HENDRICKSON TRAILER SUSPENSION SYSTEMS

#### Intraax

AANLS - 20K con Amortiguadores traseros con Altura de Manejo de 9"	B-23316	...	...	0 0	85382	...	
Modelos AA230T & AA250T con Número de E.O.	A-20002		...	...	0 0	85000	89436
	A-20126		...	...	0 0	85323	89436
	A-20889		...	...	0 0	85323	89436
	B-22345		...	...	0 0	85911	...
Modelos AAEDL Para Modelos con Altura de 12" Para Modelos con Altura de 14" a 19" Para Modelos con Altura de 9"	B-24023		...	...	0 0	85738	...
	B-23316		...	...	0 0	85382	...
	B-24579		...	...	0 0	85939	...
Modelos AAEDT 30K con Altura de 14" con Altura de 14" y 15" - Amortiguación Alta con Altura de 15", 16" & 17"	B-23361		...	...	0 0	85911	...
	B-25436		...	...	0 0	85916	89430
	B-25515		...	...	0 0	85338	...
Modelos AAL AAL 23K, 25K y 30K Amortiguador Delantero con Altura de 14" a 19" Amortiguador Delantero con con Altura de 6.5" a 9" Amortiguador Delantero con con Altura de 12" Amortiguador Trasero con Altura de 14" a 17" Amortiguador Trasero con Altura de 6.5" a 7.5" Amortiguador Trasero con Altura de 9" a 12"	A-2212		...	...	0 0	85029	...
	B-23651		...	...	0 0	85045	...
	B-23566		...	...	0 0	85000	89436
	B-25437		...	...	0 0	85337	...
	B-20345		...	...	0 0	85345	...
	B-25436		...	...	0 0	85916	89430
Modelos AANL 23K con Altura de 12" a 17" - Amortiguación Alta con Altura de 6.5" a 9" - Amortiguación Alta con Altura de 6.5" a 9" - Estándar	B-25515		...	...	0 0	85338	...
	B-24579		...	...	0 0	85939	...
	B-23651		...	...	0 0	85045	...
Modelos AANT 23K (Estándar) Amortiguación Alta Extensión Limitada Heavy Duty	B-23566		...	...	0 0	85000	89436
	B-24023		...	...	0 0	85738	...
	B-23361		...	...	0 0	85911	...
	B-24125		...	...	0 0	85323	89436

**GUÍA DE APLICACIONES – CAMIONES, TRÁILERS Y AUTOBUSES**

Año	Modelo	# E.O.	Delantero		Trasero	
						
			Fleetline	GasSLX	Fleetline	GasSLX

**HENDRICKSON TRAILER SUSPENSION SYSTEMS (Cont.)**

**Intraax (Cont.)**

Modelos AAT 23K (Estándar) Amortiguación Alta Extensión Limitada Heavy Duty	B-23566	...	...	010	<b>85000</b>	89436
	B-24023	...	...	010	<b>85738</b>	...
	B-23361	...	...	010	<b>85911</b>	...
	B-24125	...	...	010	<b>85323</b>	89436
Modelos AAT 25K (Estándar) Amortiguación Alta Extensión Limitada Heavy Duty	B-23566	...	...	010	<b>85000</b>	89436
	B-24023	...	...	010	<b>85738</b>	...
	B-23361	...	...	010	<b>85911</b>	...
	B-24125	...	...	010	<b>85323</b>	89436
Modelos AAT 30K	B-24023	...	...	010	<b>85738</b>	...
Modelos de Altura Baja con con Altura de 10.5" a 15" con Altura de 15.5" a 21" - Amortiguación Alta con Altura de 15.5" a 21" - Amortiguación Estándar con Altura de 6.5" a 8" con Altura de 6.5" a 8" - Amortiguación Alta	B-23013	...	...	010	<b>85000</b>	89436
	B-23316	...	...	010	<b>85382</b>	...
	B-23315	...	...	010	<b>85029</b>	...
	B-22311	...	...	010	<b>85045</b>	...
	B-22312	...	...	010	<b>85939</b>	...





**Top Mount Style**

HT190T (Todos los Modelos)	A-20001	...	...	010	<b>83128</b>	89436
HT230T Todos excepto los Modelos abajo enlistados ( TA14-020) ( TA15-521, TA17-521) ( TA15-522, TA17-522) (-14-020, -14-021, TA14-021) (-14-17, -15-17,-15-517,-17-517,TA15-517,TA15-520,TA17-517) (-14-7,-14-11, -15-7,-15-11,-15-12,-15-28,TA14-7,TA15-7,TA16-7,TA17-7,TB14-33,TB15-28)	A-20002	...	...	010	<b>85000</b>	89436
	B-22345	...	...	010	<b>85911</b>	...
	B-21553	...	...	010	<b>85738</b>	...
	B-21699	...	...	010	<b>87018</b>	...
	A-2212	...	...	010	<b>85029</b>	...
	A-20126	...	...	010	<b>85323</b>	89436
A-2160	...	...	010	<b>85014</b>	...	
HT250T (Todos los Modelos)	A-2212	...	...	010	<b>85029</b>	...
HT300T y N-HT300T Todos excepto los Modelos abajo enlistados ( -15-007, -15-011, -15-021,-17-007,-17-011, -17-012, TB19-007,TB19-020) ( -15-017, -15-518, -17-518,-17-520) ( TB15-027 ) ( TB15-518 )	A-20126	...	...	010	<b>85323</b>	89436
	A-2160	...	...	010	<b>85014</b>	...
	B-21553	...	...	010	<b>85738</b>	...
	B-24579	...	...	010	<b>85939</b>	...
	B-21699	...	...	010	<b>87018</b>	...
T-15-140, -155, -172, 244, -376	A-2218	...	...	010	<b>85030</b>	89440
T-15-324	A-2160	...	...	010	<b>85014</b>	...
T-17-141, -174, -284	A-2218	...	...	010	<b>85030</b>	89440
TMB-14-120	A-2213	...	...	010	<b>85010</b>	...
TMB-17-135	A-4084	...	...	010	<b>85005</b>	89430

**UnderSlung Style**

HT190U ( -6.75-001 / -6.75-002 / -6.75-003 / -6.75-020 ) ( U-7.5-517 ) ( U-9-022 / UB7-021 ) Todos excepto los Modelos arriba enlistados	A-2212	...	...	010	<b>85029</b>	...
	A-20002	...	...	010	<b>85000</b>	89436
	B-23649	...	...	010	<b>85064</b>	...
	A-20001	...	...	010	<b>83128</b>	89436
HT250U y N-HT250U (U-6.5-030, U-6.5-031) (U-6.5-27,U-9-27 & -28,U-14-28,UB6.5-522,UB7.5-27 &-522,UB9-522,UB12-27 &-28,UB14-27 &-28) (U-6.5-517, U-7.5-17, U-7.5-517, U-9-517, U-12-517, U-14-514, UB6.5-517, UB7.5-517) (U-7.5-021, U-7.5-022) (U-9-20 & -21 & -23, U-9.5-26, U-15-22, UB9-22, UB15-22)	A-2160	...	...	010	<b>85014</b>	...
	B-21553	...	...	010	<b>85738</b>	...
	A-20126	...	...	010	<b>85323</b>	89436
	A-1667	...	...	010	<b>85000</b>	89436
	A-2212	...	...	010	<b>85029</b>	...

## GUÍA DE APLICACIONES – CAMIONES, TRÁILERS Y AUTOBUSES

Año	Modelo	# E.O.	Delantero		Trasero	
			 Fleetline	 GasSLX	 Fleetline	 GasSLX

### HENDRICKSON TRAILER SUSPENSION SYSTEMS (Cont.)





#### UnderSlung Style (Cont.)

	Todos excepto los Modelos abajo enlistados	A-20002	...	...	010	<b>85000</b>	89436
	HT250US - Altura de 5.5 a 6.5" (Amortiguación Alta)	B-23744	...	...	010	<b>85344</b>	...
		S-23744	...	...	010	<b>85344</b>	...
	HT250US (Modelos con Montaje Estándar)						
	Carrera Estándar con altura de 3.5" a 4"	B-23548	...	...	010	<b>85079</b>	...
	Carrera Estándar con altura de 5.5" a 6.5"	B-23650	...	...	010	<b>85052</b>	...
	Carrera Estándar con altura de 7.5" a 14"	B-23649	...	...	010	<b>85064</b>	...
	Carrera Estándar con altura de 7.5" a 14" - Amortiguación Alta	B-23743	...	...	010	<b>85938</b>	...
	Extensión Adicional con Altura de 6.5"	B-23651	...	...	010	<b>85045</b>	...
	Extensión Adicional con Altura de 6.5" - Amortiguación Alta	B-24579	...	...	010	<b>85939</b>	...
	HT250US (Modelos con Montaje Remoto)						
	Carrera Estándar con altura de 12" a 14"	A-2212	...	...	010	<b>85029</b>	...
	Carrera Estándar con altura de 5.5" a 6.5"	B-23650	...	...	010	<b>85052</b>	...
	Carrera Estándar con altura de 7.5" a 9"	B-23649	...	...	010	<b>85064</b>	...
	Carrera Estándar con altura de 7.5" a 9" - Amortiguación Alta	B-23743	...	...	010	<b>85938</b>	...
	Extensión Adicional con Altura de 6.5" a 9"	A-2212	...	...	010	<b>85029</b>	...
	Extensión Adicional con Altura de 6.5" a 9" - Amortiguación Alta	B-23316	...	...	010	<b>85382</b>	...
	HT250US (Modelos con Montajes Angulados)						
	Carrera Estándar con altura de 6.5", 7.5" & 14"	B-23651	...	...	010	<b>85045</b>	...
	Carrera Estándar con altura de 6.5", 7.5" & 14" - Amortiguación Alta	B-24579	...	...	010	<b>85939</b>	...
	HT250U-Y (Todos los Modelos)	A-20002	...	...	010	<b>85000</b>	89436
	HT300U y N-HT300U						
	(U-7.5-519,U-9-011,U-9-519,U-12-011,U-12-015,U-14-011,U-14-015,U-17-011)	B-21699	...	...	010	<b>87018</b>	...
	Todos excepto los Modelos abajo enlistados	A-20126	...	...	010	<b>85323</b>	89436
	Modelos HT250US con Número de E.O.						
		B-21936	...	...	010	<b>85064</b>	...
		B-21947	...	...	010	<b>85052</b>	...
		B-22862	...	...	010	<b>85045</b>	...
	T-12-139	A-2213	...	...	010	<b>85010</b>	...
	T-23-US-9-011	A-2213	...	...	010	<b>85010</b>	...
	T30-US-9, -17	A-10348	...	...	010	<b>85043</b>	...
	T-4-392	A-2160	...	...	010	<b>85014</b>	...
	T-6-062, -295, -370, -422	A-1667	...	...	010	<b>85000</b>	89436
	T-6-071	A-2212	...	...	010	<b>85029</b>	...
	T-9-084	A-2240	...	...	010	<b>85013</b>	89414
	T-9-106, -278, -313	A-4084	...	...	010	<b>85005</b>	89430
	T-9-175	A-2160	...	...	010	<b>85014</b>	...
	T-9-325	A-2218	...	...	010	<b>85030</b>	89440
	T-9-390	A-2213	...	...	010	<b>85010</b>	...

#### Vantraax

	HKA180	B-24088	...	...	010	<b>85000</b>	89436
		S-24088	...	...	010	<b>85000</b>	89436
	HKA200						
	(Estándar)	B-23566	...	...	010	<b>85000</b>	89436
		S-23566	...	...	010	<b>85000</b>	89436
	Heavy Duty	B-24125	...	...	010	<b>85323</b>	89436
		S-24125	...	...	010	<b>85323</b>	89436
	HKA250						
	(Estándar)	B-23566	...	...	010	<b>85000</b>	89436
		S-23566	...	...	010	<b>85000</b>	89436
	Heavy Duty	B-24125	...	...	010	<b>85323</b>	89436
		S-24125	...	...	010	<b>85323</b>	89436
	HKAL 46K	B-23566	...	...	010	<b>85000</b>	89436

**GUÍA DE APLICACIONES – CAMIONES, TRÁILERS Y AUTOBUSES**

Año	Modelo	# E.O.	Delantero		Trasero	
						
			Fleetline	GasSLX	Fleetline	GasSLX

**HENDRICKSON TRAILER SUSPENSION SYSTEMS (Cont.)**

**Vantraax (Cont.)**

HKAL 46K	S-23566	...	...	010	<b>85000</b>	89436
HKANT 40K	B-24088	...	...	010	<b>85000</b>	89436
	S-24088	...	...	010	<b>85000</b>	89436
HKANT 46K	B-23566	...	...	010	<b>85000</b>	89436
	S-23566	...	...	010	<b>85000</b>	89436
HKANT 69K23	S-23566	...	...	010	<b>85000</b>	89436
	S-23566	...	...	010	<b>85000</b>	89436
HKARL 46K Aplicaciones de Frenos de Disco  Aplicaciones de Frenos de Tambor	B-25436	...	...	010	<b>85916</b>	89430
	S-25436	...	...	010	<b>85916</b>	89430
	B-23566	...	...	010	<b>85000</b>	89436
	S-23566	...	...	010	<b>85000</b>	89436
HKAT 46K	B-23566	...	...	010	<b>85000</b>	89436
	S-23566	...	...	010	<b>85000</b>	89436
HKAT 50K	B-24023	...	...	010	<b>85738</b>	...
	S-24023	...	...	010	<b>85738</b>	...
HKAT 69K	B-24023	...	...	010	<b>85738</b>	...
	S-24023	...	...	010	<b>85738</b>	...





**Aplicaciones Adicionales**

HK190T (Suspensión de Aire Slider)	A-21292	...	...	010	<b>85052</b>	...
HK230 (Suspensión de Aire Slider)	A-21292	...	...	010	<b>85052</b>	...
HS190T (Suspensión de Aire Slider)	A-20001	...	...	010	<b>83128</b>	89436
HS230 (Suspensión de Aire Slider)	A-20002	...	...	010	<b>85000</b>	89436
Modelos AB-32-001	A-1667	...	...	010	<b>85000</b>	89436
MT-45, MTL45, MTL-50	S-1667	...	...	010	<b>85000</b>	89436
TDC-014	665267	...	...	010	<b>85029</b>	...
	A-2212	...	...	010	<b>85029</b>	...

**Intercambios Adicionales de E.O.**

Modelos con Número de E.O.	57905-2	...	...	010	<b>85006</b>	...
	654951	...	...	010	<b>85000</b>	89436
	659024	...	...	010	<b>85052</b>	...
	665190	...	...	010	<b>85006</b>	...
	665246	...	...	010	<b>85043</b>	...
	665405	...	...	010	<b>85030</b>	89440
	665406	...	...	010	<b>85010</b>	...
	665531	...	...	010	<b>85000</b>	89436
	665532	...	...	010	<b>85013</b>	89414
	665533	...	...	010	<b>85005</b>	89430
	665536	...	...	010	<b>85000</b>	89436
	665693	...	...	010	<b>85064</b>	...
	665694	...	...	010	<b>85052</b>	...
	665698	...	...	010	<b>85911</b>	...
	665733	...	...	010	<b>85045</b>	...
	665756	...	...	010	<b>85000</b>	89436
	665758	...	...	010	<b>85064</b>	...
	665759	...	...	010	<b>85052</b>	...
	665760	...	...	010	<b>85045</b>	...
	665761	...	...	010	<b>85911</b>	...
	665763	...	...	010	<b>85079</b>	...
	665764	...	...	010	<b>85029</b>	...
	665765	...	...	010	<b>83150</b>	...
	665766	...	...	010	<b>85000</b>	89436
	665767	...	...	010	<b>85045</b>	...
	665767	...	...	010	<b>85045</b>	...

**GUÍA DE APLICACIONES – CAMIONES, TRÁILERS Y AUTOBUSES**





Año	Modelo	# E.O.	Delantero		Trasero	
						
			Fleetline	GasSLX	Fleetline	GasSLX

**HENDRICKSON TRAILER SUSPENSION SYSTEMS (Cont.)**

**Intercambios Adicionales de E.O. (Cont.)**

Modelos con Número de E.O.	671779	...	...	010	...	89414
	671948	...	...	010	85000	89436
	680102	...	...	010	85712	...
	680341	...	...	010	85323	89436
	680463	...	...	010	...	89440
	680467	...	...	010	85323	89436
	680509	...	...	010	85738	...
	680565	...	...	010	85738	...
	680566	...	...	010	85938	...
	680568	...	...	010	85323	89436
	680570	...	...	010	...	89437
	680571	...	...	010	85738	...
	680573	...	...	010	85939	...
	680573	...	...	010	85939	...
	680579	...	...	010	85939	...
	680614	...	...	010	85338	...
	680616	...	...	010	...	89430
	680617	...	...	010	85337	...
	680702	...	...	010	85323	89436
	680756	...	...	010	85323	89436
	680769	...	...	010	85911	...
	680776	...	...	010	85338	...
	98583-019	...	...	010	85323	89436
	98583-020	...	...	010	...	89414
	A-10023	...	...	010	85000	89436
	A-11931	...	...	010	85000	89436
	A-14583	...	...	010	85000	89436
	A-1668	...	...	010	85000	89436
	A-20345	...	...	010	85345	...
	A-20886	...	...	010	85030	89440
	A-20887	...	...	010	85005	89430
	A-21292	...	...	010	85052	...
	A-2230	...	...	010	85005	89430
	A-2232	...	...	010	85005	89430
	A-2240-1	...	...	010	85043	...
	A-2471	...	...	010	85006	...
	A-4089	...	...	010	83209	89414
	A-4890	...	...	010	85712	...
	A-6156	...	...	010	85301	...
	B-21832	...	...	010	85323	89436
	B-21936	...	...	010	85064	...
	B-21994	...	...	010	85938	...
	B-22312	...	...	010	85939	...
B-22715	...	...	010	85323	89436	
B-23014	...	...	010	85738	...	
B-23290	...	...	010	83150	...	
B-23362	...	...	010	...	89437	
B-23649	...	...	010	85064	...	
B-23743	...	...	010	85938	...	
B-25174	...	...	010	85029	...	
B-25437	...	...	010	85337	...	
B-26652	...	...	010	85000	89436	
B-27058	...	...	010	83128	...	
B-27747	...	...	010	85911	...	
B-29432	...	...	010	85323	89436	

**GUÍA DE APLICACIONES – CAMIONES, TRÁILERS Y AUTOBUSES**









Año	Modelo	# E.O.	Delantero		Trasero	
						
			Fleetline	GasSLX	Fleetline	GasSLX

**HENDRICKSON TRAILER SUSPENSION SYSTEMS (Cont.)**

**Intercambios Adicionales de E.O. (Cont.)**

Modelos con Número de E.O.						
B-29678	...	...	010	<b>85911</b>	...	
B-29826	...	...	010	<b>85338</b>	...	
NS500699	...	...	010	<b>85005</b>	<b>89430</b>	
S-10348	...	...	010	<b>85043</b>	...	
S-14583	...	...	010	<b>85000</b>	<b>89436</b>	
S-1668	...	...	010	<b>85000</b>	<b>89436</b>	
S-20001	...	...	010	<b>83128</b>	<b>89436</b>	
S-20002	...	...	010	<b>85000</b>	<b>89436</b>	
S-20126	...	...	010	<b>85323</b>	<b>89436</b>	
S-20345	...	...	010	<b>85345</b>	...	
S-20886	...	...	010	<b>85030</b>	<b>89440</b>	
S-20887	...	...	010	<b>85005</b>	<b>89430</b>	
S-20889	...	...	010	<b>85323</b>	<b>89436</b>	
S-21292	...	...	010	<b>85052</b>	...	
S-21553	...	...	010	<b>85738</b>	...	
S-2160	...	...	010	<b>85014</b>	...	
S-21699	...	...	010	<b>87018</b>	...	
S-21832	...	...	010	<b>85323</b>	<b>89436</b>	
S-21936	...	...	010	<b>85064</b>	...	
S-21947	...	...	010	<b>85052</b>	...	
S-2212	...	...	010	<b>85029</b>	...	
S-2213	...	...	010	<b>85010</b>	...	
S-2218	...	...	010	<b>85030</b>	<b>89440</b>	
S-2230	...	...	010	<b>85005</b>	<b>89430</b>	
S-22311	...	...	010	<b>85045</b>	...	
S-22312	...	...	010	<b>85939</b>	...	
S-2232	...	...	010	<b>85005</b>	<b>89430</b>	
S-22345	...	...	010	<b>85911</b>	...	
S-2240	...	...	010	<b>85013</b>	<b>89414</b>	
S-22715	...	...	010	<b>85323</b>	<b>89436</b>	
S-22862	...	...	010	<b>85045</b>	...	
S-23013	...	...	010	<b>85000</b>	<b>89436</b>	
S-23014	...	...	010	<b>85738</b>	...	
S-23290	...	...	010	<b>83150</b>	...	
S-23315	...	...	010	<b>85029</b>	...	
S-23316	...	...	010	<b>85382</b>	...	
S-23361	...	...	010	<b>85911</b>	...	
S-23362	...	...	010	...	<b>89437</b>	
S-23548	...	...	010	<b>85079</b>	...	
S-23649	...	...	010	<b>85064</b>	...	
S-23650	...	...	010	<b>85052</b>	...	
S-23651	...	...	010	<b>85045</b>	...	
S-23743	...	...	010	<b>85938</b>	...	
S-24023	...	...	010	<b>85738</b>	...	
S-24088	...	...	010	<b>85000</b>	<b>89436</b>	
S-24125	...	...	010	<b>85323</b>	<b>89436</b>	
S-24579	...	...	010	<b>85939</b>	...	
S-2471	...	...	010	<b>85006</b>	...	
S-25436	...	...	010	<b>85916</b>	<b>89430</b>	
S-25437	...	...	010	<b>85337</b>	...	
S-25515	...	...	010	<b>85338</b>	...	
S-26652	...	...	010	<b>85000</b>	<b>89436</b>	
S-29432	...	...	010	<b>85323</b>	<b>89436</b>	
S-29678	...	...	010	<b>85911</b>	...	
S-29826	...	...	010	<b>85338</b>	...	

## GUÍA DE APLICACIONES – CAMIONES, TRÁILERS Y AUTOBUSES

Año	Modelo	# E.O.	Delantero		Trasero	
						
						
			Fleetline	GasSLX	Fleetline	GasSLX

### HENDRICKSON TRAILER SUSPENSION SYSTEMS (Cont.)

#### Intercambios Adicionales de E.O. (Cont.)

Modelos con Número de E.O.	# E.O.	Fleetline	GasSLX	Fleetline	GasSLX
Modelos con Número de E.O.	S-4084	...	...	010	85005    89430
	S-4089	...	...	010	83209    89414
	S-4890	...	...	010	85712    ...

### HENDRICKSON TRUCK SUSPENSION SYSTEMS

#### Series Airtek

Modelos	# E.O.	Fleetline	GasSLX	Fleetline	GasSLX
Airtek Delantero					
Modelos para BlueBird	47170000456	010	85959	...	...
	58913-007	010	85959	...	...
	58913-007L	010	85959	...	...
	58913-008	010	85959	...	...
	58913-008L	010	85959	...	...
	58913-009	010	85959	...	...
	58913-009L	010	85959	...	...
	65992-003	010	85959	...	...
Modelos para Freightliner o Western Star	471700006269	010	85932	89453	...    ...
	58913-003	010	85932	89453	...    ...
	58913-012	010	85932	89453	...    ...
Modelos para International	65992-001	010	85955	...	...    ...
	65992-002	010	85955	...	...    ...
	65992-006	010	85986	...	...    ...
Modelos para Mack o Volvo	64838-001	010	85933	89454	...    ...
	64838-001L	010	85933	89454	...    ...
	64838-002	010	85933	89454	...    ...
	64838-002L	010	85933	89454	...    ...
	64838-003	010	85933	89454	...    ...
	64838-003	010	85933	89454	...    ...

#### Series All American (Modelos FE & RE)

Autobuses con Eje Steertek Hendrickson Tipo Left Hand Drive con Capacidad de 14,600 lb	58913-011	010	85959	...	...    ...
--	-----------	-----	-------	-----	------------



#### Series Comfort Air

Modelos con Número de E.O.	471700131545				
	60998-001	...	...	010	85006    ...
	60998-003	...	...	010	85006    ...
Modelos Convencionales HINO con Suspensión de Aire de Eje Sencillo	60670-013	...	...	010	83148    ...
	60670-017	...	...	010	83148    ...

#### Series Firemaax

Suspensiones de Aire Firemaax 240					
Aplicaciones de Frenos de Disco con Altura de 8 1/2" a 10"	60665-014	...	...	010	85962    ...
Aplicaciones de Frenos de Tambor con Altura de 8 1/2" a 10"	60665-018	...	...	010	85961    ...
Estándar con Altura de 12 1/2" - 14 3/8" - 15 1/2"	60665-011	...	...	010	85967    ...
Estándar con Altura de 8 1/2" a 10"	60657-003	...	...	010	85072    ...
Suspensiones de Aire Firemaax 270					
Aplicaciones de Frenos de Disco con Altura de 8 1/2" a 10"	60665-015	...	...	010	85966    ...
Aplicaciones de Frenos de Tambor con Altura de 8 1/2" a 10"	60665-013	...	...	010	85965    ...
Suspensiones de Aire Firemaax 480					
Aplicaciones de Frenos de Disco con Altura de 8 1/2" a 10"	60665-014	...	...	010	85962    ...
Aplicaciones de Frenos de Tambor con Altura de 8 1/2" a 10"	60665-018	...	...	010	85961    ...
Estándar con Altura de 12 1/2" - 14 3/8" - 15 1/2"	60665-011	...	...	010	85967    ...
Estándar con Altura de 8 1/2" a 10"	60657-003	...	...	010	85072    ...
Suspensiones de Aire Firemaax 540					
Aplicaciones de Frenos de Disco con Altura de 8 1/2" a 10"	60665-015	...	...	010	85966    ...

**GUÍA DE APLICACIONES – CAMIONES, TRÁILERS Y AUTOBUSES**

Año	Modelo	# E.O.	Delantero		Trasero	
						
			Fleetline	GasSLX	Fleetline	GasSLX

**HENDRICKSON TRUCK SUSPENSION SYSTEMS (Cont.)**

**Series Firemaax (Cont.)**

	Aplicaciones de Frenos de Tambor con Altura de 8 1/2" a 10"	60665-013	...	...	010	<b>85965</b>	...
	Suspensiones de Aire Firemaax EX 242						
	Estándar con Altura de 12 1/2" - 14 3/8" - 15 1/2"	60665-011	...	...	010	<b>85967</b>	...
	Estándar con Altura de 8 1/2" a 10"	60657-003	...	...	010	<b>85072</b>	...
	Suspensiones de Aire Firemaax EX 272						
	Aplicaciones de Frenos de Disco con Altura de 8 1/2" a 10"	60665-015	...	...	010	<b>85966</b>	...
	Aplicaciones de Frenos de Tambor con Altura de 8 1/2" a 10"	60665-013	...	...	010	<b>85965</b>	...
	Suspensiones de Aire Firemaax EX 482						
	Estándar con Altura de 12 1/2" - 14 3/8" - 15 1/2"	60665-011	...	...	010	<b>85967</b>	...
	Estándar con Altura de 8 1/2" a 10"	60657-003	...	...	010	<b>85072</b>	...
	Suspensiones de Aire Firemaax EX 542						
	Aplicaciones de Frenos de Disco con Altura de 8 1/2" a 10"	60665-015	...	...	010	<b>85966</b>	...
	Aplicaciones de Frenos de Tambor con Altura de 8 1/2" a 10"	60665-013	...	...	010	<b>85965</b>	...

**Series HA**





	HA - 180 (Excepto Mack)	47902-13	...	...	010	<b>83122</b>	<b>89406</b>
		47902-8	...	...	010	<b>83122</b>	<b>89406</b>
	HA - 200 (Excepto Mack)	47902-13	...	...	010	<b>83122</b>	<b>89406</b>
		47902-8	...	...	010	<b>83122</b>	<b>89406</b>
	HA - 230 (Excepto Mack)	47902-13	...	...	010	<b>83122</b>	<b>89406</b>
		47902-8	...	...	010	<b>83122</b>	<b>89406</b>
	HA - 360 (Excepto Mack)	47902-13	...	...	010	<b>83122</b>	<b>89406</b>
		47902-8	...	...	010	<b>83122</b>	<b>89406</b>
	HA - 400 (Excepto Mack)	47902-13	...	...	010	<b>83122</b>	<b>89406</b>
		47902-8	...	...	010	<b>83122</b>	<b>89406</b>
	HA - 460 (Excepto Mack)	47902-13	...	...	010	<b>83122</b>	<b>89406</b>
		47902-8	...	...	010	<b>83122</b>	<b>89406</b>
	HA-360/400/460 - Sistema Edge Alto Torque	60675-003	...	...	010	<b>85976</b>	...
	Suspensión de Aire - Series HA (Todos los modelos para Mack)	47902-19	...	...	010	<b>83123</b>	<b>89405</b>
		47902-9	...	...	010	<b>83123</b>	<b>89405</b>

**Series HAS**

	HAS - 120L	60670-010	...	...	010	<b>83149</b>	...
	HAS - 150L	60670-003	...	...	010	<b>83149</b>	...
	HAS - 190	60675-003	...	...	010	<b>85976</b>	...
	HAS - 190 Estándar	60670-005	...	...	010	<b>83121</b>	...
	HAS - 190L	60670-008	...	...	010	<b>83123</b>	<b>89405</b>
	HAS - 210	60675-003	...	...	010	<b>85976</b>	...
	HAS - 210 Estándar	60670-005	...	...	010	<b>83121</b>	...
	HAS - 210L	60670-008	...	...	010	<b>83123</b>	<b>89405</b>
	HAS - 230	60675-003	...	...	010	<b>85976</b>	...
	HAS - 230 Estándar	60670-005	...	...	010	<b>83121</b>	...
	HAS - 230L	60670-008	...	...	010	<b>83123</b>	<b>89405</b>
	HAS - 360	60675-003	...	...	010	<b>85976</b>	...
	HAS - 360 Estándar	60670-005	...	...	010	<b>83121</b>	...
	HAS - 400	60675-003	...	...	010	<b>85976</b>	...
		60675-006	...	...	010	<b>85909</b>	...
	HAS - 400 Estándar	60670-005	...	...	010	<b>83121</b>	...
	Suspensiones de Aire Mack & Kenworth	47902-25	...	...	010	<b>83125</b>	...



## GUÍA DE APLICACIONES – CAMIONES, TRÁILERS Y AUTOBUSES

Año	Modelo	# E.O.	Delantero		Trasero	
			 Fleetline	 GasSLX	 Fleetline	 GasSLX

### HENDRICKSON TRUCK SUSPENSION SYSTEMS (Cont.)

#### Series HAS (Cont.)

	Trasero Estándar de Casco	60670-007	...	...	010	83144	...
	HAS - 400L	60670-008	...	...	010	83123	89405
	HAS - 402	60675-003	...	...	010	85976	...
		60675-006	...	...	010	85909	...
	HAS - 402 Estándar	60670-005	...	...	010	83121	...
	Trasero Estándar de Casco	60670-007	...	...	010	83144	...
	HAS - 402L	60670-008	...	...	010	83123	89405
	HAS - 40LH	60685-001	...	...	01-	85977	...
	HAS - 40LH Estándar	60680-001	...	...	01-	83111	...
	HAS - 460	60675-003	...	...	010	85976	...
		60675-006	...	...	010	85909	...
	HAS - 460 Estándar	60670-005	...	...	010	83121	...
	Trasero Estándar de Casco	60670-007	...	...	010	83144	...
	HAS - 460L	60670-008	...	...	010	83123	89405
		60670-008L	...	...	010	83123	89405
	Modelos con Número de E.O.	60675-8Q	...	...	010	85976	...

#### Series HN

	HN - 400						
	Modelos fabricados entre Mar/96 - Sep/97	60680-003	...	...	01-	83112	...
	Modelos fabricados entre Nov/88 - Feb/96	60670-002	...	...	010	83207	89407
	HN - 402						
	Modelos fabricados entre Abr/96 - Dic/04	57241-003	...	...	01-	83112	...
		60680-003	...	...	01-	83112	...
	HN - 460						
	Modelos fabricados entre Mar/96 - Sep/97	57241-003	...	...	01-	83112	...
		60680-003	...	...	01-	83112	...
	Modelos fabricados entre Nov/88 - Feb/96	60670-002	...	...	010	83207	89407
	HN - 462						
	Modelos fabricados entre Abr/96 - Dic/04	57241-003	...	...	01-	83112	...
		60680-003	...	...	01-	83112	...
	HN - 522						
	Modelos fabricados entre Abr/96 - Dic/04	60680-003	...	...	01-	83112	...
	HNT - 460	47902-18	...	...	010	85030	89440





#### Series HTB 400 LT

	Modelos con Suspensión de Aire Trasera HTB 400LT	60657-006	...	...	010	85102	...
		60657-010	...	...	010	85102	...
		60657-011	...	...	010	85102	...

#### Series Primaax

	Modelos 230 Suspensión de Aire						
	Estándar con Altura de 12 1/2" - 14 3/8" - 15 1/2"	60665-011	...	...	010	85967	...
	Estándar con Altura de 8 1/2" a 10"	60657-003	...	...	010	85072	...
	Para Modelos International con Altura de 9"	60657-003	...	...	010	85072	...
	Modelos con Número de E.O.	60657-005	...	...	010	85087	...
	Suspensión de Aire 520						
	Aplicaciones de Frenos de Disco con Altura de 8 1/2" a 10"	60665-015	...	...	010	85966	...
	Aplicaciones de Frenos de Tambor con Altura de 8 1/2" a 10"	60665-013	...	...	010	85965	...
	Suspensión de Aire 690						
	Estándar con Altura de 12 1/2" - 14 3/8" - 15 1/2"	60665-011	...	...	010	85967	...
	Estándar con Altura de 8 1/2" a 10"	60657-003	...	...	010	85072	...
	Para Modelos International con Altura de 9"	60657-003	...	...	010	85072	...

**GUÍA DE APLICACIONES – CAMIONES, TRÁILERS Y AUTOBUSES**

Año	Modelo	# E.O.	Delantero		Trasero	
						
			Fleetline	GasSLX	Fleetline	GasSLX

**HENDRICKSON TRUCK SUSPENSION SYSTEMS (Cont.)**

**Series Primaax (Cont.)**

Suspensión de Aire 780 Aplicaciones de Frenos de Disco con Altura de 8 1/2" a 10"	60665-015		...	...	010	<b>85966</b>	...
	60665-013		...	...	010	<b>85965</b>	...
Suspensiones de Aire 260 Aplicaciones de Frenos de Disco con Altura de 8 1/2" a 10"	60665-015		...	...	010	<b>85966</b>	...
	60665-013		...	...	010	<b>85965</b>	...
Suspensiones de Aire 460 Estándar con Altura de 12 1/2" - 14 3/8" - 15 1/2"	60665-011		...	...	010	<b>85967</b>	...
	60657-003		...	...	010	<b>85072</b>	...
	60657-003		...	...	010	<b>85072</b>	...
Suspensiones de Aire EX 232 Estándar con Altura de 12 1/2" - 14 3/8" - 15 1/2"	60665-011		...	...	010	<b>85967</b>	...
	60657-003		...	...	010	<b>85072</b>	...
Suspensiones de Aire EX 262 Aplicaciones de Frenos de Disco con Altura de 8 1/2" a 10"	60665-015		...	...	010	<b>85966</b>	...
	60665-013		...	...	010	<b>85965</b>	...
Suspensiones de Aire EX 462 Estándar con Altura de 12 1/2" - 14 3/8" - 15 1/2"	60665-011		...	...	010	<b>85967</b>	...
	60657-003		...	...	010	<b>85072</b>	...
Suspensiones de Aire EX 522 Aplicaciones de Frenos de Disco con Altura de 8 1/2" a 10"	60665-015		...	...	010	<b>85966</b>	...
	60665-013		...	...	010	<b>85965</b>	...
Suspensiones de Aire EX 692 Estándar con Altura de 12 1/2" - 14 3/8" - 15 1/2"	60665-011		...	...	010	<b>85967</b>	...
	60657-003		...	...	010	<b>85072</b>	...
Suspensiones de Aire EX 782 Aplicaciones de Frenos de Disco con Altura de 8 1/2" a 10"	60665-015		...	...	010	<b>85966</b>	...
	60665-013		...	...	010	<b>85965</b>	...





**Aplicaciones Adicionales**

HMX 400/460 Haulmax con Altura de Silla de Montaje de 16.5"	60680-004		...	...	01-	<b>83143</b>	...
HMX 400/460 Haulmax con Altura de Silla de Montaje de 17.5" o 18.5"	60680-005		...	...	01-	<b>83142</b>	...
HTS 210 para Chasis Spartan (Aplicaciones Autobús Escolar Tipo C)	60665-025		...	...	010	<b>85036</b>	...
Modelos Convencionales Hino con Suspensión Hendrickson Comfort Air	60670-020		...	...	010	<b>83148</b>	...
Modelos MaxAir / AL-405	57241-006		...	...	01-	<b>83111</b>	...
Suspensión de Aire para Modelos RT2 & RTE2 (400 / 520) (Nota: Para Alturas desde 10.41" hasta 12.27" con Vigas de 52" & 54", y desde 8.52" hasta 10.37" con Vigas de 60")	57324-6		...	...	010	<b>85904</b>	...
Suspensión de Aire Trasera Hendrickson para Modelos HINO Convencionales	60670-018		...	...	010	<b>83166</b>	...
Suspensiones HAS 400 / 460 con Número de E.O.	60675-005		...	...	010	<b>85980</b>	...
Suspensiones Parasteer Modelos con Número de E.O.	59483-000	010	<b>85919</b>	...		...	...
	60665-005	010	<b>85919</b>	...		...	...
	60998-002	010	<b>85919</b>	...		...	...

**Intercambios Adicionales de E.O.**

Modelos con Número de E.O.	12738		...	...	010	<b>83225</b>	...
	47902-11		...	...	010	<b>83207</b>	89407
	47902-15		...	...	010	<b>83121</b>	...
	47902-24		...	...	010	<b>83121</b>	...
	47902-26		...	...	010	<b>83144</b>	...

**GUÍA DE APLICACIONES – CAMIONES, TRÁILERS Y AUTOBUSES**





Año	Modelo	# E.O.	Delantero		Trasero	
						
			Fleetline	GasSLX	Fleetline	GasSLX

**HENDRICKSON TRUCK SUSPENSION SYSTEMS (Cont.)**

**Intercambios Adicionales de E.O. (Cont.)**

Modelos con Número de E.O.	E.O. #	Fleetline	GasSLX	Fleetline	GasSLX
	47902-27	...	...	010	83123 89405
	47902-28	...	...	010	85013 89414
	47902-29	...	...	010	83149 ...
	47902-3	...	...	010	85005 89430
	503610C2	...	...	010	83207 89407
	5554596	...	...	010	85303 89422
	57241-001	...	...	01-	83111 ...
	57241-002	...	...	01-	83109 ...
	57241-004	...	...	01-	83110 ...
	57324-11	...	...	010	85305 ...
	57324-5	...	...	010	85903 ...
	57905-1	...	...	010	85976 ...
	58623-1	...	...	010	85978 ...
	59048-001	...	...	010	83148 ...
	59057-001	...	...	010	83137 ...
	59057-002	...	...	010	85036 89405
	59305-1	...	...	010	85979 ...
	59851-1	...	...	010	85976 ...
	59852-1	...	...	01-	85977 ...
	59852-2	...	...	01-	85977 ...
	60657-007	...	...	010	85072 ...
	60665-003	...	...	010	83137 ...
	60665-004	...	...	010	85036 89405
	60665-008	...	...	010	85978 ...
	60665-009	...	...	010	85904 ...
	60665-020	...	...	010	85919 ...
	60665-024	...	...	010	85903 ...
	60670-001	...	...	010	83123 89405
	60670-004	...	...	010	83123 89405
	60670-006	...	...	010	83147 ...
	60670-009	...	...	010	85013 89414
	60670-011	...	...	010	83148 ...
	60670-012	...	...	010	83168 ...
	60670-014	...	...	010	83166 ...
	60670-019	...	...	010	83166 ...
	60670-12	...	...	010	83168 ...
	60675-001	...	...	010	85978 ...
	60675-002	...	...	010	85979 ...
	60680-002	...	...	01-	83109 ...
	60680-009	...	...	01-	85083 ...
	60680-012	...	...	01-	85083 ...
	654890	...	...	010	83207 89407
	654891	...	...	010	83149 ...
	654894	...	...	010	83123 89405
	654895	...	...	010	83137 ...
	654896	...	...	010	83147 ...
	654897	...	...	010	83144 ...
	654897	...	...	010	83144 ...
	654898	...	...	010	83123 89405
	654899	...	...	010	85013 89414
	654900	...	...	010	83149 ...
	654903	...	...	01-	83111 ...
	654904	...	...	01-	83109 ...
	654905	...	...	01-	83112 ...
	659000	...	...	010	83148 ...

**GUÍA DE APLICACIONES – CAMIONES, TRÁILERS Y AUTOBUSES**

Año	Modelo	# E.O.	Delantero		Trasero	
						
			Fleetline	GasSLX	Fleetline	GasSLX

**HENDRICKSON TRUCK SUSPENSION SYSTEMS (Cont.)**

**Intercambios Adicionales de E.O. (Cont.)**

Modelos con Número de E.O.						
659004	...	...	010	<b>83123</b>	<b>89405</b>	
659048	...	...	01-	<b>83143</b>	...	
659049	...	...	01-	<b>83142</b>	...	
659155	...	...	010	<b>83147</b>	...	
659202	...	...	010	<b>83148</b>	...	
659292	...	...	010	<b>83148</b>	...	
665816	...	...	010	<b>85072</b>	...	
665892	...	...	010	<b>85072</b>	...	
671006	...	...	010	<b>85036</b>	<b>89405</b>	
671007	...	...	010	<b>83137</b>	...	
671009	...	...	010	<b>85919</b>	...	
671030	...	...	01-	<b>85083</b>	...	
671063	...	...	01-	<b>85083</b>	...	
671105	...	...	010	<b>85072</b>	...	
671603	...	...	010	<b>85919</b>	...	
671606	...	...	010	<b>85955</b>	...	
671611	...	...	010	<b>85955</b>	...	
671704	...	...	010	<b>85904</b>	...	
671764	...	...	010	<b>85967</b>	...	
671792	...	...	010	<b>85965</b>	...	
671793	...	...	010	<b>85966</b>	...	
671798	...	...	010	<b>85962</b>	...	
672009	...	...	010	<b>85903</b>	...	
680091	...	...	010	<b>85303</b>	<b>89422</b>	
680600	...	...	010	<b>85305</b>	...	
70018	...	...	010	<b>85303</b>	<b>89422</b>	
70021	...	...	010	<b>85303</b>	<b>89422</b>	
70088	...	...	010	<b>85307</b>	...	
98583-006	...	...	010	<b>83148</b>	...	
98583-016	...	...	010	<b>83147</b>	...	
AE76164-3	...	...	010	<b>85307</b>	...	
AE76164-4	...	...	010	<b>83225</b>	...	
BE76164-2	...	...	010	<b>85303</b>	<b>89422</b>	
BE76164-3	...	...	010	<b>85307</b>	...	
BE76164-4	...	...	010	<b>83225</b>	...	

**HIGHWAY PRODUCT**

Autobús Urbano con Suspensión de Aire	....	010	<b>83203</b>	<b>89436</b>	...	...
Autobús Urbano con Suspensión de Muelles	....	010	<b>83203 or 89436</b>			
	A1-6-134		...	...	010	<b>83207</b> <b>89407</b>
	A1-6-135	010	<b>83203</b>	<b>89436</b>	...	...

**HINO**

**Series 145**

05 - 10	Modelos con Número de E.O.	48500-3710	010	<b>83126</b>	<b>89430</b>	...	...	
		485003710A	010	<b>83126</b>	<b>89430</b>	...	...	
		S4850-03710	010	<b>83126</b>	<b>89430</b>	...	...	
		48530-3280		...	...	010	<b>G63440</b>	...
		S4853-03280		...	...	010	<b>G63440</b>	...

**Series 165**

05 - 10	Modelos con Número de E.O.	48500-3710	010	<b>83126</b>	<b>89430</b>	...	...
		485003710A	010	<b>83126</b>	<b>89430</b>	...	...
		S4850-03710	010	<b>83126</b>	<b>89430</b>	...	...
		48530-3280		...	...	010	<b>G63440</b>

## GUÍA DE APLICACIONES – CAMIONES, TRÁILERS Y AUTOBUSES

Año	Modelo	# E.O.	Delantero		Trasero	
			 Fleetline	 GasSLX	 Fleetline	 GasSLX

### HINO (Cont.)

#### Series 165 (Cont.)

05 - 10	Modelos con Número de E.O.	S4853-03280		...	...	○ ○	<b>G63440</b>	...
---------	----------------------------	-------------	--	-----	-----	-----	---------------	-----

#### Series 185

05 - 10	Modelos con Número de E.O.	48500-3710	○ ○	<b>83126</b>	89430		...	...
		485003710A	○ ○	<b>83126</b>	89430		...	...
		S4850-03710	○ ○	<b>83126</b>	89430		...	...
10	Modelos con Número de E.O.	S4850-03720	○ ○	<b>83140</b>	...		...	...
05 - 10	Modelos con Número de E.O.	48530-3280		...	...	○ ○	<b>G63440</b>	...
		S4853-03280		...	...	○ ○	<b>G63440</b>	...

#### Series 238

05 - 12	Modelos con Número de E.O.	S4850-03720	○ ○	<b>83140</b>	...		...	...
05 - 13	Modelos con Número de E.O.	48500-3720	○ ○	<b>83140</b>	...		...	...

#### Series 258

05 - 12	Modelos con Número de E.O.	S4850-03720	○ ○	<b>83140</b>	...		...	...
05 - 13	Modelos con Número de E.O.	48500-3720	○ ○	<b>83140</b>	...		...	...
	Modelos de Madrina 258 LP con Suspensión de Aire Trasera Hendrickson	48530E0100		...	...	○ ○	<b>83166</b>	...
		60670-014		...	...	○ ○	<b>83166</b>	...

#### Series 268, 268A

05 - 12	Modelos con Número de E.O.	S4850-03720	○ ○	<b>83140</b>	...		...	...
05 - 13	Modelos con Número de E.O.	48500-3720	○ ○	<b>83140</b>	...		...	...

#### Series 300

	Autobús de Pasajeros Modelos 616, 716 o 816	48511-37260	- ○	<b>83514</b>	...		...	...
		48511-89215	- ○	<b>83514</b>	...		...	...
	Autobús de Pasajeros Modelos 716 o 816	48531-37200		...	...	○ ○	<b>83505</b>	...
	Modelos 514 (2.5 - 3 Ton.)	48511-37280	- ○	<b>83512</b>	...		...	...
		48511-80123	- ○	<b>83512</b>	...		...	...
		48531-37210		...	...	○ ○	<b>83511</b>	...
		48531-80745		...	...	○ ○	<b>83511</b>	...
	Modelos 616 (4 Ton)	48531-37270		...	...	○ ○	<b>83404</b>	...
	Modelos 716 (4 / 5 Ton.)	48531-37380		...	...	○ ○	<b>83506</b>	...
	Modelos 716 o 816 (4 - 5 Ton)	48511-37290	- ○	<b>83513</b>	...		...	...
		48511-80130	- ○	<b>83513</b>	...		...	...
	Modelos 816 (4 / 5 Ton.)	48531-37380		...	...	○ ○	<b>83506</b>	...

#### Series 308

07 - 10	Modelos con Número de E.O.	48500-3720	○ ○	<b>83140</b>	...		...	...
		S4850-03720	○ ○	<b>83140</b>	...		...	...

#### Series 338

05 - 12	Modelos con Número de E.O.	S4850-03720	○ ○	<b>83140</b>	...		...	...
05 - 13	Modelos con Número de E.O.	48500-3720	○ ○	<b>83140</b>	...		...	...

#### Series 358

07 - 12	Modelos con Número de E.O.	S4850-03720	○ ○	<b>83140</b>	...		...	...
07 - 13	Modelos con Número de E.O.	48500-3720	○ ○	<b>83140</b>	...		...	...





#### Series 500

	Modelos 1018 (8 Ton)	48500-3430	- ○	<b>83507</b>	...		...	...
		S4850-03430	- ○	<b>83507</b>	...		...	...
	Modelos 1524, 1724, 1727 (10 Ton)	48500-3680	○ ○	<b>85118</b>	...		...	...
		S4850-03680	○ ○	<b>85118</b>	...		...	...
		S4850-03700	○ ○	<b>85118</b>	...		...	...

#### Series FA, FB

89 - 96	FA14, FB14	48500-1950	- ○	<b>G63610</b>	...		...	...
		48530-1910		...	...	○ ○	<b>83216</b>	...
93 - 97	FA1415 (FA15), FB1715 (FB15)	48500-1950	- ○	<b>G63610</b>	...		...	...
		48530-1910		...	...	○ ○	<b>83216</b>	...
92 - 96	FA15, FB15	48500-1950	- ○	<b>G63610</b>	...		...	...

**GUÍA DE APLICACIONES – CAMIONES, TRÁILERS Y AUTOBUSES**

Año	Modelo	# E.O.	Delantero		Trasero	
						
			Fleetline	GasSLX	Fleetline	GasSLX

**HINO (Cont.)**

**Series FA, FB (Cont.)**

92 - 96	FA15, FB15	48530-1910		...	...	010	83216	...	
98	FA1517, FA1817, FB1817	..... 48530-2510		...	...	010	G63419	...	
89 - 04	Modelos de Camión FA, FB con: Amortiguador Delantero con Número de E.O.	48500-1950	-10	G63610	...		...	...	
		48500-2750	-10	G63610	...		...	...	
		66639	-10	G63610	...		...	...	
		S4850-01950	-10	G63610	...		...	...	
		S4850-02750	-10	G63610	...		...	...	
	Amortiguador Trasero con Número de E.O.	34802			...	...	010	83216	...
		48530-1910			...	...	010	83216	...
		48530-2510			...	...	010	83216	...
		S4853-01910			...	...	010	83216	...
		S4853-02510			...	...	010	83216	...

**Series FD**

98 - 03	Camiones Modelo FD con Número de E.O.	48500-1801	010	83216	...		...	...
		48530-1880		...	...	010	83362	...
86 - 87	FD16	48500-1801	010	83216	...		...	...
		48530-1880		...	...	010	83362	...
88 - 91	FD17	48500-1801	010	83216	...		...	...
		48530-1880		...	...	010	83362	...
92	FD20	48500-1801	010	83216	...		...	...
93 - 97	FD2218, FD2218LD (FD5H). FE5H, FF5H	48500-1801	010	83216	...		...	...
		48530-1880		...	...	010	83362	...
98	FD2220, FD2220 Lo Pro	48500-1801	010	83216	...		...	...

**Series FE**

86 - 87	FE16	48500-1801	010	83216	...		...	...	
		48530-1890		...	...	010	83104	...	
84 - 91	FE17, FE19	48530-1900		...	...	010	83104	...	
92	FE20	48530-1900		...	...	010	83104	...	
93 - 97	FE2618 (FE5H)	48530-1900		...	...	010	83104	...	
98	FE2620	48530-1880		...	...	010	83362	...	
98 - 04	Modelos de Camión FE con: Amortiguador Delantero con Número de E.O.	48500-1941	010	83141	...		...	...	
		S4850-01941	010	83141	...		...	...	
		48530-1900		...	...	010	83104	...	
	Amortiguador Trasero con Número de E.O.	S4853-01900			...	...	010	83104	...
		48530-3280			...	...	010	G63440	...
		S4853-03280			...	...	010	G63440	...

**Series FF**

84 - 91	FF17, FF19	48530-1900		...	...	010	83104	...
92	FF20, FF23	48530-1900		...	...	010	83104	...
93 - 97	FF3018 (FF5H)	48530-1900		...	...	010	83104	...
93 - 97	FF3020 (FF4H)	48530-1900		...	...	010	83104	...
98	FF3320	48530-1880		...	...	010	83362	...
87 - 88	FFC1	48530-1900		...	...	010	83104	...
98 - 03	Modelos de Camión FF con Número de E.O.	48500-1941	010	83141	...		...	...
		48530-1900		...	...	010	83104	...

**Series FG**

84 - 85	FG19, FG22	48530-1900		...	...	010	83104	...
---------	------------	------------	--	-----	-----	-----	-------	-----

**Series GC**

90 - 91	GC17	48500-1801	010	83216	...		...	...
		48530-2050		...	...	010	83217	...
92	GC20	48500-1801	010	83216	...		...	...

## GUÍA DE APLICACIONES – CAMIONES, TRÁILERS Y AUTOBUSES

Año	Modelo	# E.O.	Delantero				Trasero			
			Fleetline	GasSLX	Fleetline	GasSLX				

### HINO (Cont.)

#### Series GC (Cont.)

92	GC20	48530-2050		...	...	010	<b>83217</b>	...
----	------	------------	--	-----	-----	-----	--------------	-----

#### Series SG

86	Camión Sencillo SG22	48500-1941	010	<b>83141</b>	...		...	...
87 - 92	Camión Sencillo SG23	48500-1941	010	<b>83141</b>	...		...	...
93 - 97	Camión Sencillo SG3323 (SG1H)	48500-1941	010	<b>83141</b>	...		...	...
98 - 03	Modelos de Camión SG con Número de E.O.	48500-1941	010	<b>83141</b>	...		...	...
		S4850-01941	010	<b>83141</b>	...		...	...
86 - 91	SG19	48500-1941	010	<b>83141</b>	...		...	...
92	SG20	48500-1941	010	<b>83141</b>	...		...	...
86	SG221 Tracto	48500-1941	010	<b>83141</b>	...		...	...
87 - 92	SG231 Tracto	48500-1941	010	<b>83141</b>	...		...	...
93 - 97	SG3320 (SG4H)	48500-1941	010	<b>83141</b>	...		...	...
93 - 97	SG5523 (SG1HD) Tracto	48500-1941	010	<b>83141</b>	...		...	...

#### Aplicaciones Adicionales

	Modelos Convencionales Hino con Suspensión de Aire Trasera Hendrickson	60670-014		...	...	010	<b>83166</b>	...
		60670-018		...	...	010	<b>83166</b>	...
		60670-019		...	...	010	<b>83166</b>	...
	Modelos Convencionales Hino con Suspensión Hendrickson Comfort Air	60670-013		...	...	010	<b>83148</b>	...
		60670-020		...	...	010	<b>83148</b>	...
	Modelos con Número de E.O.	48500-1800	010	<b>83216</b>	...		...	...
		48500-1940	010	<b>83141</b>	...		...	...
		48530-1120		...	...	010	<b>83104</b>	...
		48530-1460		...	...	010	<b>83215</b>	...
		48530-1620		...	...	010	<b>83104</b>	...
		48530-1770		...	...	010	<b>83215</b>	...

### HOBBS TRAILERS

	Modelos con Número de E.O.	680117		...	...	010	<b>85300</b>	<b>89419</b>
--	----------------------------	--------	--	-----	-----	-----	--------------	--------------

### HOLIDAY RAMBLER

	Modelos con Suspensión Mor-Ryde	U0109-007		...	...	010	<b>G63183</b>	...
99 - 03	Modelos Series Atlantis con Chasis Ford E450	.....	-10	<b>83177</b>	...	-10	<b>83178</b>	...
95 - 99	MotorHomes con Chasis Freightliner XC	.....	010	<b>83160</b>	...	010	<b>85029</b>	...
90 - 97	Series Admiral, Endeavor Gas & Vacationer con Chasis Motorhome F53 (7.5 L, Gas V8)	.....	010	<b>83209</b>	...	010	<b>85097</b>	...
99 - 03	Series Admiral, Endeavor Gas & Vacationer con Chasis Motorhome F53 con PBV 16,000 lb a 22,000 lb	.....	010	<b>83209</b>	...	010	<b>83122</b>	...
	Suspensión de Aire para Tráiler Modelos Neway	90044794		...	...	010	<b>83127</b>	...

### HOLLAND - BINKLEY

	Suspensión de Aire Holland ProPar NT2	680298		...	...	010	<b>85321</b>	...
	Suspensión de Aire Integrada Air Plus con Ejes Paralelos de Espiga ProPar	6898		...	...	010	<b>83125</b>	...

### HOLLAND (SEE NEWAY)

Ver Sección de SAF Holland para información de aplicación								
---	--	--	--	--	--	--	--	--



### HUTCHENS SUSPENSION

	Modelos con Número de E.O.	9423-00		...	...	010	<b>83203</b>	<b>89436</b>
--	----------------------------	---------	--	-----	-----	-----	--------------	--------------

### HYSTER

	Carga Contenedores	650150	010	<b>83217</b>			
		73516	010	<b>83217</b>			

**GUÍA DE APLICACIONES – CAMIONES, TRÁILERS Y AUTOBUSES**

Año	Modelo	# E.O.	Delantero		Trasero	
						
			Fleetline	GasSLX	Fleetline	GasSLX

**IC CORPORATION**

**Series AE para Autobuses Escolares**

	Autobuses Escolares Modelo AE con Número de E.O.	3902993C2	010	<b>83135</b>	...		...	...
		3902993C3	010	<b>83135</b>	...		...	...

**Series BE - Autobús Escolar**

- 12	Autobuses Escolares Modelo BE200 con Eje Delantero 7000 lb	3605735C1	010	<b>83156</b>	...		...	...
		3605735C2	010	<b>83156</b>	...		...	...

**Series CE - Autobús Escolar**

06 - 13	Autobuses Escolares Modelo CE (Capacidad para 71 Pasajeros) con Suspensión Delantera de 9,000 a 10,000 lb	3578105C2	010	<b>83163</b>	...		...	...
05	Autobuses Escolares Modelo CE con Eje Delantero de 6000 lb a 8000 lb	3533356C3	010	<b>83169</b>	...		...	...
06 - 13	Autobuses Escolares Modelo CE con Número de E.O.	3578105C1	010	<b>83163</b>	...		...	...
		OE13402S	010	<b>83163</b>	...		...	...
10 - 15	Autobuses Escolares Modelo CE con Suspensión de Aire Internacional IROS de 20,000 lb	3578858C2		...	...	010	<b>85926</b>	...
05 - 13	Autobuses Escolares Modelo CE con Suspensión de Muelles de 22,000 lb	501906C91		...	...	-10	<b>83317</b>	...
		501906C92		...	...	-10	<b>83317</b>	...
		OE13424S		...	...	-10	<b>83317</b>	...

**Series RE - Autobús Escolar**

	Autobuses Escolares Modelo RE con Eje Delantero 12,000 lb - 14,000 lb	2200327C1	-10	<b>85332</b>	...		...	...
	Autobuses Escolares Modelo RE con Número de E.O.	472412C91	-1-	<b>83456</b>	<b>89447</b>		...	...
	Autobuses Escolares Modelo RE con Suspensión Delantera Hendrickson AirTek	65992-006	010	<b>85986</b>	...		...	...

**Series RE Autobús Escolar**

	Autobuses Escolares Modelo RE con Suspensión Delantera Hendrickson AirTek	65992-006	010	<b>85986</b>	...		...	...
--	---	-----------	-----	--------------	-----	--	-----	-----

**INGERSOLL AXLES**

	Número de parte Ingersoll	653511-01		...	...	010	<b>85323</b>	<b>89436</b>
		653511-02		...	...	010	<b>85938</b>	...
		653511-03		...	...	010	<b>85045</b>	...
		653511-04		...	...	010	<b>85052</b>	...

**INTERNATIONAL (NAVISTAR)**

**Binder**

	Modelos Binder	453556C91	010	<b>85012</b>	<b>89413</b>		...	...
		453571C91		...	...	010	<b>83216</b>	...
		467983C91	010	<b>85012</b>	<b>89413</b>		...	...
		467985C91	010	<b>85012</b>	<b>89413</b>		...	...
		471201C91	010	<b>85012</b>	<b>89413</b>		...	...
	Tirante para Modelos S	472367C91	-1-	<b>83318</b>	...		...	...

**Camión de Bomberos**

	CO-8190	204994R91	010	<b>83225</b>	...		...	...
		308648C91	010	<b>83225</b>	...		...	...
		453561C91	010	<b>83225</b>	...		...	...
		453565C91	010	<b>83225</b>	...		...	...
		467371C91	010	<b>83225</b>	...		...	...
	Modelos con Número de E.O.	210919R91		...	...	010	<b>85307</b>	...



**Cargostar**

	CO-1600, CO-1610A & B, CO-1630A & B, CO-1700, CO-1710A & B, CO-1730A & B, CO-1750, CO-1750A & B, CO-1800, CO-1810A & B, CO-1830A & B, CO-1850, y CO-1850A & B	206620R91		...	...	010	<b>83216</b>	...
		206621R92		...	...	010	<b>83216</b>	...
		294334C91		...	...	010	<b>83216</b>	...
		3085640C92		...	...	010	<b>83216</b>	...
		308646C91		...	...	010	<b>85012</b>	<b>89413</b>





**GUÍA DE APLICACIONES – CAMIONES, TRÁILERS Y AUTOBUSES**

Año	Modelo	# E.O.	Delantero		Trasero	
			 Fleetline	 GasSLX	 Fleetline	 GasSLX

**INTERNATIONAL (NAVISTAR) (Cont.)**

**Co-Transtar and Transtar II (Cont.)**

CO-4010, COF-4010, COT-4010, COT-4010D, CO-4050, COF-4050, COT-4050, CO-4040A & B, CO-4070D, COF-4070B, COF-4070D, COT-4070D, COF-4077, COF-4077A, COF-4080D, CO-4090A, COF-4090A	426744R91	010	85303	89422		...	...
	426744R92	010	85303	89422		...	...
	453576C91	010	85303	89422		...	...
	453576C92	010	85303	89422		...	...
	477132C1	010	85303	89422		...	...
Modelos 7070B, F-7070B, CO-7070B o COF-7070B	426744R91	010	85303	89422		...	...
	426744R92	010	85303	89422		...	...
	453576C91	010	85303	89422		...	...
	453576C92	010	85303	89422		...	...
	477132C1	010	85303	89422		...	...
Modelos CO-4070A, COF-4070A, COF-4090A con Suspensión Trasera	462557C91		...	...	010	85300	89419

**DuraStar - Series 1000**

Modelos 1300	56110-T8123	-10	G63432	...		...	...
	56110-T8129	-10	G63432	...		...	...
	66400	-10	G63432	...		...	...





**DuraStar - Series 4300, 4400**

	Autobuses Escolares Modelos con Eje Delantero de 8000 lb	3533356C2	010	83135	...		...	...
02 - 15	Autobuses Escolares Modelos con Eje Delantero de 8000 lb	3533356C1	010	83135	...		...	...
13 -	Modelos con Eje Delantero 6,000 lb a 8,000 lb	3533356C3	010	83169	...		...	...
02 - 13	Modelos con Eje Delantero de 12,000 lb	3533357C2	010	85957	...		...	...
02 - 15	Modelos con Eje Delantero de 12,000 lb	3533357C1	010	85957	...		...	...
11 - 13	Modelos con Eje Delantero de 12,000 lb	3533357C3	010	85957	...		...	...
	Modelos con Suspensión de Aire International IROS	3553628C1		...	...	010	85927	...
		3553628C2		...	...	010	85927	...
		3553628C3		...	...	010	85927	...
- 15	Modelos con Suspensión de Aire International IROS de 20,000 lb	3578858C1		...	...	010	85926	...
		3578858C2		...	...	010	85926	...
- 11	Modelos con Suspensión de Aire Trasera de 40000 lb	3549099C2		...	...	010	85923	89458
02 - 13	Modelos con Suspensión de Muelles Trasera de 22,000 lb	501906C91		...	...	-10	83317	...
		501906C92		...	...	-10	83317	...
02 - 10	Modelos con Suspensión Delantera de 6,000 a 8,000 lb	3533356C2	010	83135	...		...	...
02 - 15	Modelos con Suspensión Delantera de 6,000 a 8,000 lb	3533356C1	010	83135	...		...	...
13	Modelos Perfil Bajo con Número de E.O.	1660846C92		...	...	010	83101	...
		3578105C2	010	83163	...		...	...

**Fleetstar - Convencional**

	2000D, 2010A, 2050A, 2070A, 2110A, 2150A con Suspensión de Aire Anteriores al No. de Chasis G-387453	350426C1		...	...	010	85734	...
	2000D, 2010A, 2050A, 2070A, 2110A, 2150A con Suspensión de Aire Posteriores al No. de Chasis G-387453	350425C1		...	...	010	85300	89419
		462557C91		...	...	010	85300	89419
	F-1900, T-1900, F-1950, T-1950, F-2000D, & T-2000D	210535R91	010	83225	...		...	...
		453568C91	010	83225	...		...	...
		467372C91	010	83225	...		...	...
	F-1910A, F-2010A, F-2050A & F-2070A	206621R92	010	83216	...		...	...
		308650C92	010	83216	...		...	...
		453570C91	010	83216	...		...	...
		467984C91	010	83216	...		...	...
	F-2010A, F-2050A, F-2000D con Suspensión de Aire	350425C1		...	...	010	85300	89419
		462557C91		...	...	010	85300	89419
	Modelos 1900, 1950, 2000 & 2000D	210535R91	010	83225	...		...	...
		453568C91	010	83225	...		...	...
		467372C91	010	83225	...		...	...

**GUÍA DE APLICACIONES – CAMIONES, TRÁILERS Y AUTOBUSES**

Año	Modelo	# E.O.	Delantero		Trasero	
						
			Fleetline	GasSLX	Fleetline	GasSLX

**INTERNATIONAL (NAVISTAR) (Cont.)**





**Fleetstar - Convencional (Cont.)**

Modelos 1910A, 2010A, 2050A, 2070A, 2110A & 2150A	308650C92	010	<b>83216</b>	...	...	...
	453570C91	010	<b>83216</b>	...	...	...
	467984C91	010	<b>83216</b>	...	...	...
R-185, R-190, RD-190, R-200, RD-200, RF-200, RDF-200, R-220, RD-220, R210 & RF-210	210533R91	010	<b>83225</b>	...	...	...
	210534R92	010	<b>83225</b>	...	...	...
	210535R91	010	<b>83225</b>	...	...	...
	210536R91	010	<b>83225</b>	...	...	...
	210537R91	010	<b>83225</b>	...	...	...
	210538R91	010	<b>83225</b>	...	...	...
	453562C91	010	<b>83225</b>	...	...	...
	453568C91	010	<b>83225</b>	...	...	...
	467371C91	010	<b>83225</b>	...	...	...
	467372C91	010	<b>83225</b>	...	...	...

**Loadstar - Convencional**

1600, 1600 (4x4), 1610, 1610 (4x4), 1610FC, 1700, 1700 (4x4), 1710, 1710 (4x4), F-1700, 1750, 1800, 1810, F-1800, F-1800-D, 1850, F-1850, 1890 & 1890-D con Códigos de Eje 02089, 02091	206620R91	010	<b>83216</b>	...	...	...	
	308649C91	010	<b>83216</b>	...	...	...	
	453567C91	010	<b>83216</b>	...	...	...	
1600, 1600 (4x4), 1610, 1610 (4x4), 1610FC, 1700, 1700 (4x4), 1710, 1710 (4x4), F-1700, 1750, 1800, 1810, F-1800, F-1800-D, 1850, F-1850, 1890 & 1890-D con Eje Delantero de 9000, 10800 o 12000 lb	329316C92	010	<b>85012</b>	<b>89413</b>	...	...	
	360444C91	010	<b>85012</b>	<b>89413</b>	...	...	
	453564C91	010	<b>85012</b>	<b>89413</b>	...	...	
1600, 1600(4x4), 1610, 1610(4x4), 1700, 1700(4x4), 1710, 1710(4x4), F-1700, 1750, 1800, 1810, F-1800, F-1800-D, 1850, F-1850, 1890 & 1890-D Exc. Códigos de Eje 02054, 02057, 02059, 02089, 02091, 02098, 02101, 02109, 02139, 02208, 02218, 02228, 02309, 0232	308668C92	010	<b>85012</b>	<b>89413</b>	...	...	
	453556C91	010	<b>85012</b>	<b>89413</b>	...	...	
	467985C91	010	<b>85012</b>	<b>89413</b>	...	...	
	874695R91	010	<b>85012</b>	<b>89413</b>	...	...	
Modelos 1600	467983C91	010	<b>85012</b>	<b>89413</b>	...	...	
	471201C91	010	<b>85012</b>	<b>89413</b>	...	...	
Modelos 1600, 1600 (4x4), 1610, 1610 (4x4), 1700, 1700 (4x4), 1710, 1710 (4x4), 1750, 1800, 1810, 1850, 1890 & 1890-D	206620R91		...	...	010	<b>83216</b>	...
	206621R91		...	...	010	<b>83216</b>	...
	308649C91		...	...	010	<b>83216</b>	...
	308650C92		...	...	010	<b>83216</b>	...
	329316C92		...	...	010	<b>85012</b>	<b>89413</b>
	360444C91		...	...	010	<b>85012</b>	<b>89413</b>
	383379C91		...	...	010	<b>83308</b>	...
	453564C91		...	...	010	<b>85012</b>	<b>89413</b>
	453567C91		...	...	010	<b>83216</b>	...
	453570C91		...	...	010	<b>83216</b>	...
	453575C91		...	...	010	<b>83308</b>	...
	467983C91		...	...	010	<b>85012</b>	<b>89413</b>
	467984C91		...	...	010	<b>83216</b>	...
	471203C91		...	...	010	<b>83308</b>	...
	474002C91		...	...	010	<b>83308</b>	...
	873622C91		...	...	010	<b>83308</b>	...
Modelos 1600, 1610FC, 1700, 1700 (4x4), 1800, 1890, 1890D	384435C91		...	...	010	<b>83216</b>	...
	453571C91		...	...	010	<b>83216</b>	...
	462753C91		...	...	010	<b>83216</b>	...

**GUÍA DE APLICACIONES – CAMIONES, TRÁILERS Y AUTOBUSES**

Año	Modelo	# E.O.	Delantero		Trasero	
						
			Fleetline	GasSLX	Fleetline	GasSLX

**INTERNATIONAL (NAVISTAR) (Cont.)**

**Loadstar - Convencional (Cont.)**

	Modelos 1700, 1750, 1800, 1850 con Suspensión de Aire	462557C91		...	...	010	<b>85300</b>	<b>89419</b>
	Modelos M1600, M1700, M1800, M1900, M2100	453576C92	010	<b>85303</b>	<b>89422</b>		...	...

**PayStar - Series 5000**

	Modelos 5010, F-5010, F-5050, F-5050SF, 5070, F-5070, F-5070SF	426744R91	010	<b>85303</b>	<b>89422</b>		...	...
		426744R92	010	<b>85303</b>	<b>89422</b>		...	...
		453576C91	010	<b>85303</b>	<b>89422</b>		...	...
		453576C92	010	<b>85303</b>	<b>89422</b>		...	...
		477132C1	010	<b>85303</b>	<b>89422</b>		...	...
- 12	Modelos 5600i con Eje Delantero 16,000 lb	1667520C1	010	<b>85058</b>	<b>89431</b>		...	...
04 - 12	Modelos 5900 SB con Eje Delantero 18,000 lb	1667520C1	010	<b>85058</b>	<b>89431</b>		...	...
- 15	Modelos 5900 SB con Suspensión de Aire Hendrickson Primaax 230, 460 y 690 (Altura desde 8-1/2" a 10")	60657-003		...	...	010	<b>85072</b>	...
- 15	Modelos 5900 SB con Suspensión de Aire Hendrickson Primaax EX 232, 462 y 692 (Altura desde 8-1/2" a 10")	60657-003		...	...	010	<b>85072</b>	...
04 - 15	Modelos 5900 SB con Suspensión de Aire Trasera Hendrickson de 46,000 lb	3626571C1		...	...	010	<b>85072</b>	...
		H60657-003		...	...	010	<b>85072</b>	...
09 - 11	Modelos 5900i con Eje Delantero 12,000 lb - 14,000 lb	2015556C1	-10	<b>85316</b>	<b>89426</b>		...	...
04 - 12	Modelos 5900i SFA con Eje Delantero 16,000 lb	1667520C1	010	<b>85058</b>	<b>89431</b>		...	...
04 - 09	Modelos 5900i SFA con Suspensión de Aire Trasera Neway de 46,000 lb	2029200C91		...	...	010	<b>83126</b>	<b>89430</b>
		90044626		...	...	010	<b>83126</b>	<b>89430</b>
	Modelos con Número de E.O.	3576465C2	010	<b>85999</b>	...		...	...
		3816234C1	010	<b>85999</b>	...		...	...
10 -	Modelos con Suspensión Delantera de Muelles de 12,000 lb a 14,000 lb	3868264C1	010	<b>85998</b>	...		...	...
- 13	Modelos con Suspensión Hendrickson HMX 400/460 Haulmax con Silla de Montaje de 16.5"	60680-004		...	...	01-	<b>83143</b>	...

**Series - CXT**

	Modelos CXT con Número de E.O.	3606770C1	010	<b>83163</b>	...		...	...
		3606770C2	010	<b>83163</b>	...		...	...









**Series 1000 Chasis Forward Control**

	Modelos 1452, 1652	453576C92	010	<b>85303</b>	<b>89422</b>		...	...
		472412C91	-1-	<b>83456</b>	<b>89447</b>		...	...
		586724C91	-1-	<b>83456</b>	<b>89447</b>		...	...
	Modelos 1452, 1652 con Suspensión de Aire International	1675455C1		...	...	010	<b>85003</b>	<b>89411</b>
		1690035C1		...	...	010	<b>85003</b>	<b>89411</b>
		2018987C1		...	...	010	<b>85003</b>	<b>89411</b>
		2018987C2		...	...	010	<b>85003</b>	<b>89411</b>
		501553C91		...	...	010	<b>85003</b>	<b>89411</b>
	Modelos 1452, 1652 con Suspensión Trasera MOR-RYDE	548532C1		...	...	-1-	<b>83103</b>	...
	Modelos 1654 LP (Vehículos Perfil Bajo)	1660846C91		...	...	010	<b>83101</b>	...
		1660846C92		...	...	010	<b>83101</b>	...
		1663471C1	-1-	<b>83103</b>	...		...	...
		2039565C1	010	<b>83100</b>	...		...	...
	Modelos M1400, M1600	472412C91	-1-	<b>83456</b>	<b>89447</b>		...	...
		501905C91		...	...	-10	<b>83301</b>	...
		586724C91	-1-	<b>83456</b>	<b>89447</b>		...	...

**Series 2000 - Conventional Truck (Severe Service)**

	Modelos 2554, 2574, 2654, 2674	472412C91	-1-	<b>83456</b>	<b>89447</b>		...	...
	Modelos 2554, 2574, 2654, 2674 con Suspensión de Aire International	1675455C1		...	...	010	<b>85003</b>	<b>89411</b>
		1690035C1		...	...	010	<b>85003</b>	<b>89411</b>
		2018987C1		...	...	010	<b>85003</b>	<b>89411</b>
		2018987C2		...	...	010	<b>85003</b>	<b>89411</b>
		501553C91		...	...	010	<b>85003</b>	<b>89411</b>

## GUÍA DE APLICACIONES – CAMIONES, TRÁILERS Y AUTOBUSES

Año	Modelo	# E.O.	Delantero		Trasero	
						
						
			Fleetline	GasSLX	Fleetline	GasSLX

### INTERNATIONAL (NAVISTAR) (Cont.)

#### Series 2000 - Conventional Truck (Severe Service) (Cont.)

Modelos 2554, 2574, 2654, 2674 con Suspensión Trasera International Vari-Rate	501506C91		...	...	-10	<b>83317</b>	...
Todos los Modelos 2000 con Eje Delantero de 12000 lb sin Eje Delantero de 12000 lb y con Muelles de 16000 o 18000 lb sin Eje Delantero de 12000 lb y sin Muelles de 16000 o 18000 lb	472412C91	-1-	<b>83456</b>	89447		...	...
	1667520C1	010	<b>85058</b>	89431		...	...
	2015556C1	-10	<b>85316</b>	89426		...	...

#### Series 3000 - Chasis Autobús Escolar

Modelos 3700, 3800	472412C91	-1-	<b>83456</b>	89447		...	...
	501905C91		...	...	-10	<b>83301</b>	...
	501906C91		...	...	-10	<b>83317</b>	...
	586724C91	-1-	<b>83456</b>	89447		...	...
Modelos 3700, 3800 con Suspensión de Aire Internacional	1675455C1		...	...	010	<b>85003</b>	89411
	1690035C1		...	...	010	<b>85003</b>	89411
	2018987C1		...	...	010	<b>85003</b>	89411
	2018987C2		...	...	010	<b>85003</b>	89411
	501553C91		...	...	010	<b>85003</b>	89411
Modelos 3700, 3800 con Suspensión de Aire Neway ARD-234	537524C91		...	...	010	<b>83123</b>	89405
	537525C91		...	...	010	<b>83123</b>	89405
Modelos 3700, 3800 con Suspensión Trasera MOR-RYDE	548532C1		...	...	-1-	<b>83103</b>	...
Modelos 3900FC	1677707C1	010	<b>85030</b>	89440		...	...
	2015557C1	010	<b>85030</b>	89440		...	...
	467371C91	010	<b>83225</b>			...	...
Modelos 3900FC (Genesis - Motor Delantero)	2200327C1	-10	<b>85332</b>	...		...	...
Modelos 3900FC (Genesis - Motor Trasero)	2039549C1	-10	<b>85333</b>	...		...	...





#### Series 400, 500, 600, 700, & 900 - Camión & Tractor Mediano Cabina Abatible (Nissan)

Modelos 400	56101 Z5008	-10	<b>83114</b>	...		...	...
	56101 Z5011	-10	<b>G63610</b>	...		...	...
Modelos 500	56101 Z5011	-10	<b>G63610</b>	...		...	...
Modelos 600, 700, 900	56101 Z1030	-10	<b>85311</b>	89424		...	...
	56101 Z2000	-10	<b>85311</b>	89424		...	...

#### Series 4000 - Camión & Tractor Mediano Convencional Corto

Modelos 4000 con Suspensión de Aire Trasera Hendrickson HAS-230	AMS650420		...	...	010	<b>85013</b>	89414
Modelos 4600, 4700, 4800, 4900	1663606C91	-1-	<b>85027</b>	89418		...	...
	1667520C1	010	<b>85058</b>	89431		...	...
	586724C91	-1-	<b>83456</b>	89447		...	...
Modelos 4600, 4700, 4800, 4900 con Eje Delantero 10000 lb	472412C91	-1-	<b>83456</b>	89447		...	...
Modelos 4600, 4700, 4800, 4900 con Suspensión de Aire Internacional (Exc. Perfil Bajo)	1675455C1		...	...	010	<b>85003</b>	89411
	1690035C1		...	...	010	<b>85003</b>	89411
	2018987C1		...	...	010	<b>85003</b>	89411
	2018987C2		...	...	010	<b>85003</b>	89411
	501553C91		...	...	010	<b>85003</b>	89411
Modelos 4600LP, 4700LP (Perfil Bajo) U-Haul	540395C91	-1-	<b>83613</b>	...		...	...
	540395C92	-1-	<b>83613</b>	...		...	...
<b>- 94</b> Modelos 4600LP, 4700LP (Perfil Bajo) U-Haul	1675496C91		...	...	010	<b>83636</b>	...
	1675496C92		...	...	010	<b>83636</b>	...
<b>02/95-</b> Modelos 4600LP, 4700LP (Perfil Bajo) U-Haul	2039565C1		...	...	010	<b>83100</b>	...
Modelos F-4900 & 4600LP (Vehículo Perfil Bajo)	501906C91		...	...	-10	<b>83317</b>	...
	501906C92		...	...	-10	<b>83317</b>	...
				...	...	-10	<b>83317</b>
<b>90 - 02</b> Modelos F-4900 con Eje Delantero de 10000 lb	472412C91	-1-	<b>83456</b>	89447		...	...
<b>90 - 02</b> Modelos F-4900 con Puertas Dobles	2015556C1	-10	<b>85316</b>	89426		...	...
Modelos F-4900 con Suspensión Trasera Hendrickson Modelos HN - 400	60680-003		...	...	01-	<b>83112</b>	...

**GUÍA DE APLICACIONES – CAMIONES, TRÁILERS Y AUTOBUSES**

Año	Modelo	# E.O.	Delantero		Trasero	
						
			Fleetline	GasSLX	Fleetline	GasSLX

**INTERNATIONAL (NAVISTAR) (Cont.)**

**Series 405 (Cont.)**

D-405, DB-405, DC-405, DCO-405, DF-405 & VCO-405 Exc. con Código de Eje 02136	426744R91	010	<b>85303</b>	89422		...	...
	453576C91	010	<b>85303</b>	89422		...	...
DBF-405, DCF-405, DCOF-405 & VCOF-405 con Código de Eje 02136	293009C91	010	<b>85308</b>	89422		...	...
	426744R91	010	<b>85303</b>	89422		...	...
	453576C91	010	<b>85303</b>	89422		...	...
	453577C91	010	<b>85308</b>	89422		...	...
DT-405, DBT-405, DCT-405, DCOT-405 & VCOT-405 con Código de Eje 02136	293009C91	010	<b>85308</b>	89422		...	...
	426744R91	010	<b>85303</b>	89422		...	...
	453576C91	010	<b>85303</b>	89422		...	...
	453577C91	010	<b>85308</b>	89422		...	...
DT-405, DBT-405, DCT-405, DCOT-405 & VCOT-405 Exc. Código de Eje 02136	426744R91	010	<b>85303</b>	89422		...	...
	453576C91	010	<b>85303</b>	89422		...	...

**Series 417**

DCO-417 & DCOF-417	426744R91	010	<b>85303</b>	89422		...	...
	453576C91	010	<b>85303</b>	89422		...	...

**Series 5000, 5000i - Camión & Tractor Convencional Servicio Pesado**

Modelos 6 X 4 con Suspensión de Aire Neway AD-246 y Espacio entre Ejes de 60" Estándar	2029200C91		...	...	010	<b>83126</b>	89430	
	AMS 600172		...	...	010	<b>83126</b>	89430	
	Heavy Duty	2029200C91		...	...	010	<b>85030</b>	89440
		AMS 600172		...	...	010	<b>85030</b>	89440









**Series 7000 - Camión & Tractor Mediano Convencional Corto**

Autobús Escolar Modelos 7000 con Número de E.O.	3609400C1		...	...	-10	<b>83317</b>	...
	3609400C2		...	...	-10	<b>83317</b>	...
Modelos 7100	1663606C91	-1-	<b>85027</b>	89418		...	...
	472412C91	-1-	<b>83456</b>	89447		...	...
	586724C91	-1-	<b>83456</b>	89447		...	...
Modelos 7100 con Suspensión de Aire International	1675455C1		...	...	010	<b>85003</b>	89411
	1690035C1		...	...	010	<b>85003</b>	89411
	2018987C1		...	...	010	<b>85003</b>	89411
	2018987C2		...	...	010	<b>85003</b>	89411
	501553C91		...	...	010	<b>85003</b>	89411
Modelos 7300, 7400, 7500, 7600 con Suspensión IAS Altura de Manejo 5,3"	3544766C1		...	...	010	<b>85930</b>	...

**Series 8000 - Tractor Convencional Heavy Duty**

Estándar	2029200C91		...	...	010	<b>83126</b>	89430	
	AMS 600172		...	...	010	<b>83126</b>	89430	
	Heavy Duty	2029200C91		...	...	010	<b>85030</b>	89440
		AMS 600172		...	...	010	<b>85030</b>	89440
Modelos 8100 - Modelos 6 X 4 & 4 X 2 con Suspensión de Aire International para Perfil Bajo y Remolque	1660846C91		...	...	010	<b>83101</b>	...	
	1660846C92		...	...	010	<b>83101</b>	...	
Modelos 8100 Remolque	1664524C1		...	...	-10	<b>85935</b>	...	
	472412C91	-1-	<b>83456</b>	89447		...	...	
Modelos 8100, 8200 & 8300 - Modelos 6 X 4 con Suspensión de Aire International (Excepto Perfil Bajo y Remolque)	2018987C1		...	...	010	<b>85003</b>	89411	
	2018987C2		...	...	010	<b>85003</b>	89411	
Modelos 8100, 8200, 8300	3000070C91	-1-	<b>83456</b>	89447		...	...	
	501906C91		...	...	-10	<b>83317</b>	...	
Modelos 8100, 8200, 8300 - con Suspensión de Aire Hendrickson HA-460 con distancia entre ejes 55" & 60" y capacidad de 40000 & 46000 lb	AMS 600102		...	...	010	<b>85005</b>	89430	

## GUÍA DE APLICACIONES – CAMIONES, TRÁILERS Y AUTOBUSES

Año	Modelo	# E.O.	Delantero		Trasero	
						
						
			Fleetline	GasSLX	Fleetline	GasSLX

### INTERNATIONAL (NAVISTAR) (Cont.)

#### Series 8000 - Tractor Convencional Heavy Duty (Cont.)

	Modelos 8100, 8200, 8300 - con Suspensión de Aire Trasera Hendrickson HA-230	AMS 600102		...	...	OIO	<b>85005</b>	89430
	Modelos 8100, 8200, 8300 con Suspensión de 12000 lb - 14000 lb	1664788C2	-IO	<b>85316</b>	89426		...	...
		2015556C1	-IO	<b>85316</b>	89426		...	...
	Modelos 8100, 8200, 8300 con Suspensión de 15000 lb - 18000 lb	1667520C1	OIO	<b>85058</b>	89431		...	...
	Modelos 8100, 8200, 8300 con Suspensión de Aire International	1675455C1		...	...	OIO	<b>85003</b>	89411
		1690035C1		...	...	OIO	<b>85003</b>	89411
		501553C91		...	...	OIO	<b>85003</b>	89411
<b>07 - 08</b>	Modelos 8600 con Suspensión Delantera de Muelles	3670156C1	OIO	<b>85954</b>	...		...	...



#### Series 9100, 9100i - Tractor & Camión

	Modelos 4 X 2 con Suspensión de Aire International	2018987C1		...	...	OIO	<b>85003</b>	89411
		2018987C2		...	...	OIO	<b>85003</b>	89411
	Modelos 6 X 4 con Suspensión de Aire International	2018987C1		...	...	OIO	<b>85003</b>	89411
		2018987C2		...	...	OIO	<b>85003</b>	89411
	Modelos 6 X 4 con Suspensión de Aire International para Perfil Bajo  Estándar  Heavy Duty	1660846C91		...	...	OIO	<b>83101</b>	...
		1660846C92		...	...	OIO	<b>83101</b>	...
		2029200C91		...	...	OIO	<b>83126</b>	89430
		AMS 600172		...	...	OIO	<b>83126</b>	89430
		2029200C91		...	...	OIO	<b>85030</b>	89440
		AMS 600172		...	...	OIO	<b>85030</b>	89440
	Modelos 9100 con Suspensión de 12000 lb - 14000 lb	1664788C2	-IO	<b>85316</b>	89426		...	...
		2015556C1	-IO	<b>85316</b>	89426		...	...
		2032533C1	-IO	<b>85316</b>	89426		...	...
	Modelos 9100 con Suspensión de Aire Hendrickson HA-460	AMS 600102		...	...	OIO	<b>85005</b>	89430

#### Series 9200, 9200i - Tractor & Camión

	Modelos 4 X 2 con Suspensión de Aire International	2018987C1		...	...	OIO	<b>85003</b>	89411
		2018987C2		...	...	OIO	<b>85003</b>	89411
<b>- 08//94</b>	Modelos 4 X 2 con Suspensión de Aire International	1675496C91		...	...	OIO	<b>83636</b>	...
		1675496C92		...	...	OIO	<b>83636</b>	...
	Modelos 6 X 4 con Ejes Delanteros 12,000 a 14,000 lb	3581109C3	OIO	<b>85924</b>	89457		...	...
		3581109C4	OIO	<b>85924</b>	89457		...	...
	Modelos 6 X 4 con Suspensión de Aire International	2018987C1		...	...	OIO	<b>85003</b>	89411
		2018987C2		...	...	OIO	<b>85003</b>	89411
	Modelos 6 X 4 con Suspensión de Aire International para Perfil Bajo  Estándar  Heavy Duty	1660846C91		...	...	OIO	<b>83101</b>	...
		1660846C92		...	...	OIO	<b>83101</b>	...
		2029200C91		...	...	OIO	<b>83126</b>	89430
		AMS 600172		...	...	OIO	<b>83126</b>	89430
		2029200C91		...	...	OIO	<b>85030</b>	89440
		AMS 600172		...	...	OIO	<b>85030</b>	89440
	Modelos con Cabina Dormitorio & Suspensión Hendrickson AirTek	3609178C1	OIO	<b>85955</b>	...		...	...
		3660548C1	OIO	<b>85955</b>	...		...	...
		65992-001	OIO	<b>85955</b>	...		...	...
	Modelos con Day Cab & Suspensión Hendrickson AirTek	3613984C1	OIO	<b>85955</b>	...		...	...
		3660549C1	OIO	<b>85955</b>	...		...	...
		65992-002	OIO	<b>85955</b>	...		...	...
<b>00 - 07</b>	Modelos con Eje Delantero de 12,000 lb	3581107C1	OIO	<b>85924</b>	89457		...	...
		3581107C2	OIO	<b>85924</b>	89457		...	...
		3581107C3	OIO	<b>85924</b>	89457		...	...
<b>04 - 09</b>	Modelos con Eje Delantero de 12,000 lb	3584535C3	OIO	<b>85924</b>	89457		...	...
	Modelos con Suspensión de 12,000 - 18,000 lb	1664788C2	-IO	<b>85316</b>	89426		...	...
		2015556C1	-IO	<b>85316</b>	89426		...	...

**GUÍA DE APLICACIONES – CAMIONES, TRÁILERS Y AUTOBUSES**

Año	Modelo	# E.O.	Delantero		Trasero	
						
			Fleetline	GasSLX	Fleetline	GasSLX

**INTERNATIONAL (NAVISTAR) (Cont.)**

**Series 9200, 9200i - Tractor & Camión (Cont.)**

	Modelos con Suspensión de 12,000 - 18,000 lb	2032533C1	-10	85316	89426		...	...
	Modelos con Suspensión de Aire Hendrickson HA-460	AMS 600102		...	...	010	85005	89430
	Modelos con Suspensión de Aire International	1675455C1		...	...	010	85003	89411
		1690035C1		...	...	010	85003	89411
		501553C91		...	...	010	85003	89411
04 - 09	Modelos con Suspensión de Aire Trasera de 40000 lb	3586883C1		...	...	010	85931	89458
	Modelos con Suspensión IAS - Altura de 9.25" o 9.5"	3573265C1		...	...	010	85931	89458

**Series 9300, 9300i, 9400 & 9400i - Camión & Tractor Convencional con Cofre Largo**





	Modelos 6 X 4 con Suspensión de Aire International Exc. Perfil Bajo	2018987C1		...	...	010	85003	89411
		2018987C2		...	...	010	85003	89411
	Modelos 6 X 4 con Suspensión de Aire International para Perfil Bajo  Estándar  Heavy Duty	1660846C91		...	...	010	83101	...
		1660846C92		...	...	010	83101	...
		2029200C91		...	...	010	83126	89430
		AMS 600172		...	...	010	83126	89430
		2029200C91		...	...	010	85030	89440
		AMS 600172		...	...	010	85030	89440
	Modelos con Cabina Dormitorio & Suspensión Hendrickson AirTek	3609178C1	010	85955	...		...	...
		3660548C1	010	85955	...		...	...
		65992-001	010	85955	...		...	...
	Modelos con Day Cab & Suspensión Hendrickson AirTek	3613984C1	010	85955	...		...	...
		3660549C1	010	85955	...		...	...
		65992-002	010	85955	...		...	...
00 - 07	Modelos con Eje Delantero de 12,000 lb	3581107C1	010	85924	89457		...	...
		3581107C2	010	85924	89457		...	...
		3581107C3	010	85924	89457		...	...
04 - 09	Modelos con Eje Delantero de 12,000 lb	3584535C3	010	85924	89457		...	...
	Modelos con Suspensión de 10,800 lb - 14,600 lb	503610C2	010	83207	89407		...	...
	Modelos con Suspensión de 12,000 - 14,000 lb	1664788C2	-10	85316	89426		...	...
		2015556C1	-10	85316	89426		...	...
		2032533C1	-10	85316	89426		...	...
	Modelos con Suspensión de 16,000 - 18,000 lb	1667520C1	010	85058	89431		...	...
	Modelos con Suspensión de Aire Hendrickson HA-460	AMS 600102		...	...	010	85005	89430
	Modelos con Suspensión de Aire International	1675455C1		...	...	010	85003	89411
		1690035C1		...	...	010	85003	89411
		501553C91		...	...	010	85003	89411
	Modelos con Suspensión de Aire Neway ARD-125/244	790335C91		...	...	010	83209	89414
04 - 09	Modelos con Suspensión de Aire Trasera de 40000 lb	3586883C1		...	...	010	85931	89458
	Modelos con Suspensión de Aire Trasera Hendrickson RS/RTE-380	503610C2		...	...	010	83207	89407
	Modelos con Suspensión de Aire Trasera Hendrickson RS-460	2015557C1		...	...	010	85030	89440
	Modelos con Suspensión IAS - Altura de 9.25" o 9.5"	3573265C1		...	...	010	85931	89458
	Modelos de Eje con Desplazamiento hacia Adelante con Suspensión de 16,000 lb a 18,000 lb	507202C1	010	85030	89440		...	...
	Modelos de Eje con Desplazamiento hacia Atrás con Suspensión de 16,000 lb a 18,000 lb	1664149C1	010	85029	...		...	...

**Series 9600 & 9700 - Tractor Premium Cabina Abatible**

	Modelos 9600, 9700	503610C2	010	83207	89407		...	...
		507202C1	010	85030	89440		...	...
	Modelos 9600, 9700 con Suspensión de 16000 - 18000 lb	1667520C1	010	85058	89431		...	...
	Modelos 9600, 9700 con Suspensión de Aire Hendrickson HA-460 con distancia entre ejes de 55" o 60" y capacidad de 40000 o 46000 lb	AMS 600102		...	...	010	85005	89430
	Modelos 9600, 9700 con Suspensión de Aire Neway ARD-125/244	790335C91		...	...	010	83209	89414
	Modelos 9600, 9700 con Suspensión de Aire Neway ARD-234	537524C91		...	...	010	83123	89405



## GUÍA DE APLICACIONES – CAMIONES, TRÁILERS Y AUTOBUSES

Año	Modelo	# E.O.	Delantero		Trasero	
						
			Fleetline	GasSLX	Fleetline	GasSLX

### INTERNATIONAL (NAVISTAR) (Cont.)

#### Series 9600 & 9700 - Tractor Premium Cabina Abatible (Cont.)

Modelos 9600, 9700 con Suspensión de Internacional STL Spring	503550C1		...	...	OIO	83207	89407
Modelos 9600, 9700 Excepto Perfil Bajo	1664788C2	-IO	85316	89426		...	...
	2015556C1	-IO	85316	89426		...	...
Modelos 9600, 9700 Perfil Bajo	503610C2	OIO	83207	89407		...	...
Modelos con Suspensión de Aire International	1675455C1		...	...	OIO	85003	89411
	1690035C1		...	...	OIO	85003	89411
	2018987C1		...	...	OIO	85003	89411
	2018987C2		...	...	OIO	85003	89411
	501553C91		...	...	OIO	85003	89411



#### Series 9800 - Tractor Premium Cabina Abatible

Modelos 6 X 4 con Suspensión de Aire International  Estándar  Heavy Duty	2018987C1		...	...	OIO	85003	89411
	2018987C2		...	...	OIO	85003	89411
	2029200C91		...	...	OIO	83126	89430
	AMS 600172		...	...	OIO	83126	89430
	2029200C91		...	...	OIO	85030	89440
	AMS 600172		...	...	OIO	85030	89440
Modelos 9800 - con Eje con Desplazamiento hacia Atrás	2015556C1	-IO	85316	89426		...	...
Modelos 9800 - con Eje con Desplazamiento hacia Delante	503610C2	OIO	83207	89407		...	...
Modelos 9800 - con Suspensión de Aire Hendrickson HA-460 con distancia entre ejes de 55" & 60" y capacidad de 40000 & 46000 lb	AMS 600102		...	...	OIO	85005	89430
Modelos 9800 - con Suspensión de Aire Hendrickson HAS-402-60	AMS 650420		...	...	OIO	85013	89414

#### Series 9900, 9900i, 9900ix Camión & Tractor Convencional con Cofre Largo

	Modelos 6 X 4 con Suspensión de Aire International Exc. Perfil Bajo	2018987C1		...	...	OIO	85003	89411
		2018987C2		...	...	OIO	85003	89411
	Modelos 6 X 4 con Suspensión de Aire International para Perfil Bajo  Estándar  Heavy Duty	1660846C91		...	...	OIO	83101	...
		1660846C92		...	...	OIO	83101	...
		2029200C91		...	...	OIO	83126	89430
		AMS 600172		...	...	OIO	83126	89430
		2029200C91		...	...	OIO	85030	89440
		AMS 600172		...	...	OIO	85030	89440
<b>04 - 09</b>	Modelos con Eje Delantero de 12,000 lb	3584535C3	OIO	85924	89457		...	...
<b>13 -</b>	Modelos con Eje Delantero de 12,000 lb	3810581C4	OIO	85995			...	...
	Modelos con Suspensión de 10,800 lb - 14,600 lb	503610C2	OIO	83207	89407		...	...
	Modelos con Suspensión de 12,000 - 14,000 lb	1664788C2	-IO	85316	89426		...	...
		2015556C1	-IO	85316	89426		...	...
		2032533C1	-IO	85316	89426		...	...
	Modelos con Suspensión de 16,000 - 18,000 lb	1667520C1	OIO	85058	89431		...	...
	Modelos con Suspensión de Aire Hendrickson HA-460	AMS 600102		...	...	OIO	85005	89430
	Modelos con Suspensión de Aire International	1675455C1		...	...	OIO	85003	89411
		1690035C1		...	...	OIO	85003	89411
		501553C91		...	...	OIO	85003	89411
	Modelos con Suspensión de Aire Neway ARD-125/244	790335C91		...	...	OIO	83209	89414
<b>04 - 11</b>	Modelos con Suspensión de Aire Trasera de 40000 lb	3586883C1		...	...	OIO	85931	89458
<b>- 15</b>	Modelos con Suspensión de Aire Trasera Hendrickson HAS - 230	H60675-003		...	...	OIO	85976	...
	Modelos con Suspensión de Aire Trasera Hendrickson RS/RTE-380	503610C2		...	...	OIO	83207	89407
	Modelos con Suspensión de Aire Trasera Hendrickson RS-460	2015557C1		...	...	OIO	85030	89440
<b>- 15</b>	Modelos con Suspensión de Aire Trasera International de 40,000 lb (Espaciado de 52" - Heavy Duty)	3688616C1		...	...	OIO	85923	89458
<b>10 -</b>	Modelos con Suspensión Delantera de Muelles de 12,000 lb a 14,000 lb	3868264C1	OIO	85998			...	...
<b>- 11</b>	Modelos Day Cab con Ejes Delanteros de 12,000 lb	3581106C1	OIO	85924	89457		...	...

**GUÍA DE APLICACIONES – CAMIONES, TRÁILERS Y AUTOBUSES**

Año	Modelo	# E.O.	Delantero		Trasero	
						
			Fleetline	GasSLX	Fleetline	GasSLX

**INTERNATIONAL (NAVISTAR) (Cont.)**

**Series 9900, 9900i, 9900ix Camión & Tractor Convencional con Cofre Largo (Cont.)**

- 11	Modelos Day Cab con Ejes Delanteros de 12,000 lb	3581106C2	010	<b>85924</b>	89457		...	...
		3581106C3	010	<b>85924</b>	89457		...	...
	Modelos de Eje con Desplazamiento hacia Adelante con Suspensión de 16,000 lb a 18,000 lb	507202C1	010	<b>85030</b>	89440		...	...
	Modelos de Eje con Desplazamiento hacia Atrás con Suspensión de 16,000 lb a 18,000 lb	1664149C1	010	<b>85029</b>	...		...	...

**Series A, B, AC y BC Convencional**

	Modelos A-140 (4 x 4)	....		...	...	010	<b>83216</b>	...
	Modelos A-160, B-160, AC-160, BC-160	308649C91		...	...	010	<b>83216</b>	...
		308650C91		...	...	010	<b>83216</b>	...
		453567C91		...	...	010	<b>83216</b>	...
	Modelos A-170, B-170, AC-170, BC-170, A-180, B-180, AC-180, BC-180	308646C91	010	<b>85012</b>	89413		...	...
		308649C91		...	...	010	<b>83216</b>	...
		308650C91		...	...	010	<b>83216</b>	...
		453567C91		...	...	010	<b>83216</b>	...
	Modelos AB-140	....	010	<b>G63306</b>				
	Modelos AC-170 & BC-170 (4 x 4)	....		...	...	010	<b>83216</b>	...
	Modelos AC-180 & BC-180 (4 x 4)	....		...	...	010	<b>83216</b>	...
	Modelos ACF-170 & BCF-170	308646C91		...	...	010	<b>85012</b>	89413
	Modelos BCF-195-D	....		...	...	010	<b>83225</b>	...
	Modelos C-150	....	010	<b>G63306</b>	...		...	...
		308649C91		...	...	010	<b>83216</b>	...
		308668C91		...	...	010	<b>85012</b>	89413
		453556C91		...	...	010	<b>85012</b>	89413
		453567C91		...	...	010	<b>83216</b>	...

**Series BE - Autobús Escolar**

- 12	Chasis Autobús Escolar Modelo BE200 con Eje Delantero de 7000 lb	3605735C1	010	<b>83156</b>	...		...	...
		3605735C2	010	<b>83156</b>	...		...	...
	con Suspensión Trasera de 9000 lb	3609400C1		...	...	-10	<b>83317</b>	...
		3609400C2		...	...	-10	<b>83317</b>	...





**Series CE - Autobús Escolar**

06 - 13	Autobuses Escolares Modelo CE (Capacidad para 71 Pasajeros) con Suspensión Delantera de 9,000 a 10,000 lb	3578105C2	010	<b>83163</b>	...		...	...
05	Autobuses Escolares Modelo CE con Eje Delantero de 6000 lb a 8000 lb	3533356C3	010	<b>83169</b>	...		...	...
06 - 13	Autobuses Escolares Modelo CE con Número de E.O.	3578105C1	010	<b>83163</b>	...		...	...
		OE13402S	010	<b>83163</b>	...		...	...
10 - 15	Autobuses Escolares Modelo CE con Suspensión de Aire Internacional IROS de 20,000 lb	3578858C2		...	...	010	<b>85926</b>	...
05 - 13	Autobuses Escolares Modelo CE con Suspensión de Muelles de 22,000 lb	501906C92		...	...	-10	<b>83317</b>	...
		OE13424S		...	...	-10	<b>83317</b>	...

**Series F & S**

	Modelos 1600, 1700, 1800, 1900, 2100	300070C91	-1-	<b>83456</b>	89447		...	...
		453576C92	010	<b>85303</b>	89422		...	...
	Modelos 1600, 1700, 1800, 1900, 2100 con Suspensión de Aire Internacional	1675455C1		...	...	010	<b>85003</b>	89411
		1690035C1		...	...	010	<b>85003</b>	89411
		2018987C1		...	...	010	<b>85003</b>	89411
		2018987C2		...	...	010	<b>85003</b>	89411
		501553C91		...	...	010	<b>85003</b>	89411
	Modelos 1600, 1700, 1800, 1900, 2100 con Suspensión de Aire Neway ARD-234	537524C91		...	...	010	<b>83123</b>	89405
	Modelos 1624, 1654, 1724, 1754, 1824, 1854, 1924, F1924, 1925, 1954, F1954, 1955, 2124, 2125, F2125, 2154, 2155 Exc. con Códigos de Eje Trasero 14029, 14030, 14187	501905C91		...	...	-10	<b>83301</b>	...

**GUÍA DE APLICACIONES – CAMIONES, TRÁILERS Y AUTOBUSES**

Año	Modelo	# E.O.	Delantero		Trasero	
						
			Fleetline	GasSLX	Fleetline	GasSLX

**INTERNATIONAL (NAVISTAR) (Cont.)**





**Series F & S (Cont.)**

	Modelos 1624, 1654, 1724, 1754, 1824, 1854, 1924, F1924, 1925, 1954, F1954, 1955, 2124, 2125, F2125, 2154, 2155 Exc. con Códigos de Eje Trasero 14029, 14030, 14187	501906C91		...	...	-10	<b>83317</b>	...
	Modelos 1624, 1654, 1724, 1754, 1824, 1854, 1924, F1924, 1925, 1954, F1954, 1955, 2124, 2125, F2125, 2154, 2155 con Códigos de Eje Trasero 14029, 14030, 14187	501905C91		...	...	-10	<b>83301</b>	...
	Modelos 1624, 1654, 1724, 1754, 1824, 1854, 1924, F1924, 1925, 1954, F1954, 1955, 2124, 2125, F2125, 2154, 2155 con Eje Delantero 5000, 6000 o 7500 lb	472367C91	-1-	<b>83318</b>	...		...	...
	Modelos 1624, 1654, 1724, 1754, 1824, 1854, 1924, F1924, 1925, 1954, F1954, 1955, 2124, 2125, F2125, 2154, 2155 con Eje Delantero 9000, 10800 o 12000 lb	472411C91	-1-	<b>83456</b>	89447		...	...
472412C91		-1-	<b>83456</b>	89447		...	...	
586724C91		-1-	<b>83456</b>	89447		...	...	
	Modelos 1924, 1954 (6 x 6)	472367C91	-1-	<b>83318</b>	...		...	...
		472414C91	-1-	<b>83318</b>	...		...	...
	Modelos 2275, F2275, 2524, F2524, 2554, F2554, 2574, F2574, 2575, F2575, F2624, F2654, F2674 con Eje Delantero 9000, 10800 o 12000 lb	472411C91	-1-	<b>83456</b>	89447		...	...
		472412C91	-1-	<b>83456</b>	89447		...	...
		586724C91	-1-	<b>83456</b>	89447		...	...
	Modelos 2275, F2275, 2524, F2524, 2554, F2554, 2574, F2574, 2575, F2575, F2624, F2654, F2674 con Suspensión de Aire Internacional	1675455C1		...	...	010	<b>85003</b>	89411
		1690035C1		...	...	010	<b>85003</b>	89411
		2018987C1		...	...	010	<b>85003</b>	89411
		2018987C2		...	...	010	<b>85003</b>	89411
		501553C91		...	...	010	<b>85003</b>	89411
	Modelos 2275, F2275, 2524, F2524, 2554, F2554, 2574, F2574, 2575, F2575, F2624, F2654, F2674 con Suspensión de Aire Internacional Corporate - Para Uso Estándar	501553C91		...	...	010	<b>85003</b>	89411
	Modelos 2275, F2275, 2524, F2524, 2554, F2554, 2574, F2574, 2575, F2575, F2624, F2654, F2674 con Suspensión de Aire Internacional Corporate - Para Uso Severo	1675455C1		...	...	010	<b>85003</b>	89411
	Modelos 2275, F2275, 2524, F2524, 2554, F2554, 2574, F2574, 2575, F2575, F2624, F2654, F2674 con Suspensión de Aire Neway ARD-125/244	790335C91		...	...	010	<b>83209</b>	89414
	Modelos 2275, F2275, 2524, F2524, 2554, F2554, 2574, F2574, 2575, F2575, F2624, F2654, F2674 con Suspensión de Aire Neway ARD-234	537524C91		...	...	010	<b>83123</b>	89405
	Modelos 2275, F2275, 2524, F2524, 2554, F2554, 2574, F2574, 2575, F2575, F2624, F2654, F2674 con Suspensión Trasera Ridwell	534464C1		...	...	010	<b>85734</b>	...

**Series LoneStar**

<b>08 - 10</b>	Modelos con Muelle Delantera de 12,000 lb	3819277C1	010	<b>85969</b>	...		...	...
		3819279C1	010	<b>85969</b>	...		...	...
<b>13 -</b>	Modelos con Número de E.O.	3810581C4	010	<b>85995</b>	...		...	...
<b>12 - 14</b>	Modelos con Suspensión de Aire Trasera Internacional de 40,000 lb (Espaciado de 52" - Heavy Duty)	3688614C1		...	...	010	<b>85923</b>	89458
<b>12 - 15</b>	Modelos con Suspensión de Aire Trasera Internacional de 40,000 lb (Espaciado de 52" - Heavy Duty)	3688616C1		...	...	010	<b>85923</b>	89458
<b>12 - 15</b>	Modelos con Suspensión Delantera de Muelles de 12,350 lb	3813341C2	010	<b>85963</b>	...		...	...
		3813341C3	010	<b>85963</b>	...		...	...
<b>09 - 15</b>	Modelos Day Cab con Muelles Parabólicas Delanteras de 14,600 lb	3813341C1	010	<b>85963</b>	...		...	...
		3813341C2	010	<b>85963</b>	...		...	...
		3813341C3	010	<b>85963</b>	...		...	...
<b>09 - 14</b>	Modelos de Cabina Dormitorio con Muelles Delanteras Parabólicas Taperleaf de 14,000 lb	3813340C1	010	<b>85964</b>	...		...	...
		3813340C2	010	<b>85964</b>	...		...	...
<b>09 - 15</b>	Modelos de Cabina Dormitorio con Muelles Delanteras Parabólicas Taperleaf de 14,000 lb	3813340C3	010	<b>85964</b>	...		...	...
<b>09 - 15</b>	Todos los Modelos con Suspensión Trasera de 40,000 lb	3620395C1		...	...	010	<b>85931</b>	89458

**GUÍA DE APLICACIONES – CAMIONES, TRÁILERS Y AUTOBUSES**

Año	Modelo	# E.O.	Delantero		Trasero	
						
			Fleetline	GasSLX	Fleetline	GasSLX

**INTERNATIONAL (NAVISTAR) (Cont.)**





**Series Metro & Multi-Shop (Cont.)**

	AM y AMC-160, AMC-164	308649C91 453567C91	010	<b>83216</b>	...		...	...
			010	<b>83216</b>	...		...	...
	M1600, MC1600, M1700 & MC1700	206620R91 308649C91 308668C91 308669C91 453556C91 453597C91 874695R91 874696R91		...	...	010	<b>83216</b>	...
				...	...	010	<b>83216</b>	...
			010	<b>85012</b>	<b>89413</b>		...	...
			010	<b>85012</b>	<b>89413</b>		...	...
			010	<b>85012</b>	<b>89413</b>		...	...
				...	...	010	<b>83216</b>	...
			010	<b>85012</b>	<b>89413</b>		...	...
			010	<b>85012</b>	<b>89413</b>		...	...
	MA1200, M1400, M1500, MA1500	287318C91 308649C91 308669C91 453531C91 453556C91 453557C91 453567C91 467980C91	010	<b>G63306</b>				
				...	...	010	<b>83216</b>	...
				...	...	010	<b>85012</b>	<b>89413</b>
				...	...	010	<b>G63306</b>	...
				...	...	010	<b>85012</b>	<b>89413</b>
				...	...	010	<b>G63306</b>	...
				...	...	010	<b>83216</b>	...
			010	<b>G63306</b>				
	Modelos M1600, M1700, M1800, M1900, M2100	453576C92	010	<b>85303</b>	<b>89422</b>		...	...
	Modelos M1600, M1700, M1800, M1900, M2100 - Exc. Con Códigos de Eje Trasero 14029, 14030, 14187	501905C91 501906C91		...	...	-10	<b>83301</b>	...
				...	...	-10	<b>83317</b>	...
	Modelos M1600, M1700, M1800, M1900, M2100 con Códigos de Eje Delantero 02109, 02118, 02309, 02127, 02139, 02329, 02339	472412C91 586724C91	-1-	<b>83456</b>	<b>89447</b>		...	...
			-1-	<b>83456</b>	<b>89447</b>		...	...
	Modelos M1600, M1700, M1800, M1900, M2100 con Eje Delantero de 5000, 6000 o 7500 lb	472367C91	-1-	<b>83318</b>	...		...	...
	Modelos M1600, M1700, M1800, M1900, M2100 con Eje Delantero de 9000, 10800 o 12000 lb	472411C91	-1-	<b>83456</b>	<b>89447</b>		...	...
<b>66 - 72</b>	Modelos Metro M1200 - Exc. Código de Chasis 01000.0962	.....	010	<b>G63299</b>	...		...	...
<b>66 - 72</b>	Modelos Metro M1200 con Código de Eje 0208 & Código de Chasis 01000.09622	.....	010	<b>G63306</b>				
<b>66 - 72</b>	Modelos Metro M1200 con Código de Muelles Auxiliares 03204	.....		...	...	010	<b>G63299</b>	...
<b>66 - 72</b>	Modelos Metro M1200 con Muelles Traseras Regulares 14016 & Código de Eje Trasero 14020	.....	010	<b>G63306</b>				
<b>66 - 72</b>	Modelos Metro M700, 800, 900-U, 1000, 1100	.....	010	<b>G63306</b>				
<b>73 - 75</b>	Modelos MS-1210 & 1510 Paradas Continuas	.....		...	...	010	<b>G63306</b>	...

**Series ProStar**

	Modelos con Cabina Dormitorio con Número de E.O.	3737575C1	010	<b>85954</b>	...		...	...
<b>- 13</b>	Modelos con Cabina Dormitorio y Suspensión de Aire	3610198C1	010	<b>85963</b>	...		...	...
<b>- 14</b>	Modelos con Cabina Dormitorio y Suspensión de Muelles de 12,350 lb	3606857C1 3606857C2	010	<b>85954</b>	...		...	...
<b>14 - 15</b>	Modelos con Cabina Dormitorio y Suspensión de Muelles de 12,350 lb	3606857C3	010	<b>85994</b>	...		...	...
	Modelos con Day Cab y Suspensión de Aire	3610199C1	010	<b>85964</b>	...		...	...
<b>- 12</b>	Modelos con Day Cab y Suspensión Delantero de Muelles Taperleaf	3606859C1 3606859C2	010	<b>85954</b>	...		...	...
<b>13 -</b>	Modelos con Day Cab y Suspensión Delantero de Muelles Taperleaf	3606859C3	010	<b>85994</b>	...		...	...
<b>13 -</b>	Modelos con Dormitorios de 113"	3806341C3 3810581C4	010	<b>85995</b>	...		...	...
			010	<b>85995</b>	...		...	...
	Modelos con Número de E.O.	3668566C1 3688729C1 3688732C1 3737576C1	010	<b>85954</b>	...		...	...
				...	...	010	<b>85931</b>	<b>89458</b>
				...	...	010	<b>85931</b>	<b>89458</b>
				...	...	010	<b>85931</b>	<b>89458</b>

**GUÍA DE APLICACIONES – CAMIONES, TRÁILERS Y AUTOBUSES**

Año	Modelo	# E.O.	Delantero		Trasero	
						
			Fleetline	GasSLX	Fleetline	GasSLX

**INTERNATIONAL (NAVISTAR) (Cont.)**





**Series ProStar (Cont.)**

- 15	Modelos con Suspensión de Aire Trasera Hendrickson HAS - 230	60675-003		...	...	010	<b>85976</b>	...
		H60675-003		...	...	010	<b>85976</b>	...
	Modelos con Suspensión de Aire Trasera Hendrickson HTB 400LT	60657-006		...	...	010	<b>85102</b>	...
		60657-010		...	...	010	<b>85102</b>	...
		60657-011		...	...	010	<b>85102</b>	...
		H60657-006		...	...	010	<b>85102</b>	...
		H60657-010		...	...	010	<b>85102</b>	...
		H60657-011		...	...	010	<b>85102</b>	...
09 - 15	Modelos Day Cab con Muelles Parabólicas Delanteras de 14,600 lb	3813341C3	010	<b>85963</b>	...		...	...
09 - 15	Todos los Modelos con Suspensión Trasera de 40,000 lb	3620395C1		...	...	010	<b>85931</b>	<b>89458</b>

**Series S - Autobús Escolar**

	1603, 1703, 1803 & 1853 - Exc. Códigos de Eje 02054, 02057, 02059, 02089, 02091, 02098, 02101, 02109, 02139, 02208, 02218, 02228, 02309, 02329, 02339	308668C92	010	<b>85012</b>	<b>89413</b>		...	...
		453556C91	010	<b>85012</b>	<b>89413</b>		...	...
		467985C91	010	<b>85012</b>	<b>89413</b>		...	...
		874695R91	010	<b>85012</b>	<b>89413</b>		...	...
	1603, 1703, 1803 & 1853 con Códigos de Eje 02089, 02091	206620R91	010	<b>83216</b>	...		...	...
		308649C91	010	<b>83216</b>	...		...	...
		453567C91	010	<b>83216</b>	...		...	...
		467984C91	010	<b>83216</b>	...		...	...
	1603, 1703, 1803 & 1853 con Eje Delantero 9000, 10800 o 12000 lb	320444C91	010	<b>85012</b>	<b>89413</b>		...	...
		329316C92	010	<b>85012</b>	<b>89413</b>		...	...
		453564C91	010	<b>85012</b>	<b>89413</b>		...	...
		467983C91	010	<b>85012</b>	<b>89413</b>		...	...
	173 FC & 183 FC con Códigos de Eje 14149 & 14189	210535R91		...	...	010	<b>83225</b>	...
		453568C91		...	...	010	<b>83225</b>	...
		467372C91		...	...	010	<b>83225</b>	...
	173 FC & 183 FC - Exc. Códigos de Eje 14149 & 14189	210918R91		...	...	010	<b>83215</b>	...
		453574C91		...	...	010	<b>85307</b>	...
	1853 FC & 1853 DFC con Código de Eje 14136	210919R91		...	...	010	<b>85307</b>	...
		308664C91		...	...	010	<b>85307</b>	...
		453574C91		...	...	010	<b>85307</b>	...
	1853 FC & 1853 DFC con Código de Eje 14149 con Números de Serie FD	453567C91		...	...	010	<b>83216</b>	...
		210533R91		...	...	010	<b>83225</b>	...
	1853 FC & 1853 DFC con Códigos de Eje 14039, 14139, 14149 & 14189 - Exc. 14149 con Números de Serie FD	210534R92		...	...	010	<b>83225</b>	...
		453562C91		...	...	010	<b>83225</b>	...
		467371C91		...	...	010	<b>83225</b>	...
		208664C91		...	...	010	<b>85307</b>	...
	1853 FC & 1853 DFC con Códigos de Eje 14044, 14045, 14060, 14145, 14146, 14150 y 14186	210919R91		...	...	010	<b>85307</b>	...
		453574C91		...	...	010	<b>85307</b>	...
		206620R91		...	...	010	<b>83216</b>	...
	Modelos 1603, 1703, 1803 & 1853	206621R91		...	...	010	<b>83216</b>	...
		306444C91		...	...	010	<b>85012</b>	<b>89413</b>
		308649C91		...	...	010	<b>83216</b>	...
		308650C92		...	...	010	<b>83216</b>	...
		329316C92		...	...	010	<b>85012</b>	<b>89413</b>
		383379C91		...	...	010	<b>83308</b>	...
		453564C91		...	...	010	<b>85012</b>	<b>89413</b>
		453567C91		...	...	010	<b>83216</b>	...
		453570C91		...	...	010	<b>83216</b>	...

**GUÍA DE APLICACIONES – CAMIONES, TRÁILERS Y AUTOBUSES**

Año	Modelo	# E.O.	Delantero		Trasero	
						
			Fleetline	GasSLX	Fleetline	GasSLX

**INTERNATIONAL (NAVISTAR) (Cont.)**

**Series S - Autobús Escolar (Cont.)**

	Modelos 1603, 1703, 1803 & 1853	453575C91	010	...	...	010	<b>83308</b>	...	
		467983C91		...	...	010	<b>85012</b>	<b>89413</b>	
		471201C91		<b>85012</b>	<b>89413</b>			...	...
		471203C91		...	...	010	<b>83308</b>	...	...
		474002C91		...	...	010	<b>83308</b>	...	...
		873622C91		...	...	010	<b>83308</b>	...	...
	Modelos 1723 S con Eje Delantero 5000, 6000 o 7500 lb	472367C91	-1-	<b>83318</b>	...		...	...	
	Modelos 1723, 1823, 1853 con Suspensión de Aire Neway ARD-234	537524C91		...	...	010	<b>83123</b>	<b>89405</b>	
	Modelos 1723, 1823, 1853 con Suspensión de Aire International	1675455C1		...	...	010	<b>85003</b>	<b>89411</b>	
		1690035C1		...	...	010	<b>85003</b>	<b>89411</b>	
		2018987C1		...	...	010	<b>85003</b>	<b>89411</b>	
		2018987C2		...	...	010	<b>85003</b>	<b>89411</b>	
		501553C91		...	...	010	<b>85003</b>	<b>89411</b>	
	Modelos 173 FC, 183 FC, 183RE, 193 RE	204994R91	010	<b>83225</b>	...		...	...	
		308648C91	010	<b>83225</b>	...		...	...	
		453561C91	010	<b>83225</b>	...		...	...	
		453565C91	010	<b>83225</b>	...		...	...	
		467371C91	010	<b>83225</b>	...		...	...	
	Modelos 1823 S - Exc. con Códigos de Eje Trasero 14029,14030, 14187	501906C91		...	...	-10	<b>83317</b>	...	
	Modelos 1823, 1853 S con Eje Delantero 9000, 10800 o 12000 lb	472411C91	-1-	<b>83456</b>	<b>89447</b>		...	...	
		472412C91	-1-	<b>83456</b>	<b>89447</b>		...	...	
		586724C91	-1-	<b>83456</b>	<b>89447</b>		...	...	
	Modelos 183 RE con Códigos de Eje 14043, 14147 & 14186	210533R91		...	...	010	<b>83225</b>	...	
		210534R92		...	...	010	<b>83225</b>	...	
		453562C91		...	...	010	<b>83225</b>	...	
		467371C91		...	...	010	<b>83225</b>	...	
	Modelos 1853 DFC3	210920R91	010	<b>85308</b>	<b>89422</b>		...	...	
		453579C91	010	<b>85308</b>	<b>89422</b>		...	...	
	Modelos 1853 FC & 1853 DFC	204994R91	010	<b>83225</b>	...		...	...	
		308648C91	010	<b>83225</b>	...		...	...	
		453561C91	010	<b>83225</b>	...		...	...	
		453565C91	010	<b>83225</b>	...		...	...	
		467371C91	010	<b>83225</b>	...		...	...	
	Modelos 193 RE	210920R91	010	<b>85308</b>	<b>89422</b>		...	...	
		453579C91	010	<b>85308</b>	<b>89422</b>		...	...	
	Modelos 193 RE - Exc. Códigos de Eje 14039 & 14189	210533R91		...	...	010	<b>83225</b>	...	
		210534R92		...	...	010	<b>83225</b>	...	
		453562C91		...	...	010	<b>83225</b>	...	
		467371C91		...	...	010	<b>83225</b>	...	





**TerraStar**

<b>12</b>	Modelos con Eje Delantero 6,000 lb a 7,000 lb	3902993C1	010	<b>83167</b>	...		...	...
<b>13 - 14</b>	Modelos con Eje Delantero 6,000 lb a 7,000 lb	3902993C3	010	<b>83135</b>	...		...	...
<b>12</b>	Modelos con Número de E.O.	6E7Z-18125-A	010	...	...	010	<b>83146</b>	...
		OE17103		<b>83167</b>	...		...	...
<b>13 - 14</b>	Modelos con Número de E.O.	OE 18513	010	<b>83135</b>	...		...	...
	Modelos con Suspensión de Aire International IROS	3892445C3		...	...	010	<b>85931</b>	<b>89458</b>
<b>12 - 15</b>	Modelos con Suspensión Trasera de Muelles de 13,500 lb	3586902C3		...	...	010	<b>83146</b>	...

**TranStar - Series 8500, 8600**

<b>03 - 10</b>	Modelos con Eje Delantero de 12,000 lb	3533357C2	010	<b>85957</b>	...		...	...
		3588209C1	010	<b>85957</b>	...		...	...
		3588209C2	010	<b>85957</b>	...		...	...
<b>03 - 15</b>	Modelos con Eje Delantero de 12,000 lb	3533357C1	010	<b>85957</b>	...		...	...

**GUÍA DE APLICACIONES – CAMIONES, TRÁILERS Y AUTOBUSES**

Año	Modelo	# E.O.	Delantero		Trasero	
						
			Fleetline	GasSLX	Fleetline	GasSLX

**INTERNATIONAL (NAVISTAR) (Cont.)**

**TranStar - Series 8500, 8600 (Cont.)**

- 13	Modelos con Número de E.O.	3674348C1	0 0	85954	...		...	...
03 - 13	Modelos con Suspensión de Aire Trasera de 40000 lb	3549099C1		...	...	0 0	85923	89458
		3549099C2		...	...	0 0	85923	89458

**Transtar - Convencional**

	4170, F-4170, 4200, F-4200, 4300 & F-4300 con Suspensión de Aire	350425C1		...	...	0 0	85300	89419
		462557C91		...	...	0 0	85300	89419
	D-400, DF-400, DC-400, DCF-400 & DCF-400M con Código de Eje 02136	293009C91	0 0	85308	89422		...	...
		453577C91	0 0	85308	89422		...	...
	D-400, DF-400, DC-400, DCF-400 & DCF-400M Exc. Código de Eje 02136	426744R91	0 0	85303	89422		...	...
		426744R92	0 0	85303	89422		...	...
		453576C91	0 0	85303	89422		...	...
	Modelos 4170, F-4170, 4200, F-4200, 4300 o F-4300	426744R91	0 0	85303	89422		...	...
		426744R92	0 0	85303	89422		...	...
		453576C91	0 0	85303	89422		...	...
		453576C92	0 0	85303	89422		...	...
		477132C1	0 0	85303	89422		...	...

**Unistar**

	CO7044A	426744R91	0 0	85303 or 89422				
		426744R92	0 0	85303 or 89422				
		453576C91	0 0	85303 or 89422				
	Intercambios Adicionales de E.O.	56101 Z5008	- 0	83114				
		596329C1	0 0	85014				





**WorkStar - Series 7000**

11 - 15	Modelos 7400, 7500, 7600 con Eje Delantero 12,000 lb	3533357C2	0 0	85957	...		...	...
		3533357C3	0 0	85957	...		...	...
- 15	Modelos 7400, 7500, 7600 con Eje Delantero 18,000 lb	3576464C1	0 0	85957	...		...	...
		3576464C2	0 0	85957	...		...	...
11 - 14	Modelos 7400, 7500, 7600 con Eje Delantero 20,000 lb	3558089C3	0 0	85925	...		...	...
	Modelos 7400, 7500, 7600 con Suspensión Hendrickson HAS - 400 (Interior Trasero Estándar)	60670-007		...	...	0 0	83144	...
	Modelos con Número de E.O.	3576465C2	0 0	85999	...		...	...
		3816234C1	0 0	85999	...		...	...
- 15	Modelos con Suspensión de Aire Hendrickson Primaax 230, 460 y 690 (Altura desde 8-1/2" a 10")	60657-003		...	...	0 0	85072	...
- 15	Modelos con Suspensión de Aire Hendrickson Primaax EX 232, 462 y 692 (Altura desde 8-1/2" a 10")	60657-003		...	...	0 0	85072	...
10 -	Modelos con Suspensión Delantera de Muelles de 12,000 lb a 14,000 lb	3868264C1	0 0	85998	...		...	...
- 14	Modelos con Suspensión Hendrickson HMX 400/460 Haulmax con Silla de Montaje de 16.5"	60680-004		...	...	0 -	83143	...
	Modelos S7700 con Suspensión Delantera Multietapas	3588591C1	0 0	85953	...		...	...
		3588591C2	0 0	85953	...		...	...
		3588592C1	0 0	85953	...		...	...
		3588592C2	0 0	85953	...		...	...
	Intercambios Adicionales de E.O.	453527C91	- 0	85311 or 89424				
		453528C91	- 0	85311 or 89424				
		462603C91	- -	85705 or 89447				
		463926C91	- -	85705 or 89447				

**Intercambios Adicionales de E.O.**

	Modelos con Suspensión Meritor AirLink	446-51-211		...	...	0 0	85739	...
	Modelos con Suspensión Trasera Chalmers de 40,000 lb	800670		...	...	0 0	85060	...
	Modelos con Número de E.O.	3000098C1		...	...	- 0	83317	...
		3514952C1		...	...	0 0	85976	...
		3571711C1	- 0	85316	89426		...	...

**GUÍA DE APLICACIONES – CAMIONES, TRÁILERS Y AUTOBUSES**

Año	Modelo	# E.O.	Delantero		Trasero	
						
			Fleetline	GasSLX	Fleetline	GasSLX

**INTERNATIONAL (NAVISTAR) (Cont.)**

**Intercambios Adicionales de E.O. (Cont.)**





Modelos con Número de E.O.	3581109C1	010	<b>85924</b>	89457		...	...	
	3584116C1	010	<b>83175</b>	...		...	...	
	3584116C2	010	<b>83175</b>	...		...	...	
	3584117C1	010	<b>83135</b>	...		...	...	
	3584117C2	010	<b>83135</b>	...		...	...	
	3584118C1	010	<b>85928</b>	...		...	...	
	3584118C2	010	<b>85928</b>	...		...	...	
	3584535C1	010	<b>85924</b>	89457		...	...	
	3584535C2	010	<b>85924</b>	89457		...	...	
	3586902C2	010	...	...	010	<b>83146</b>	...	
	3601600C1	010	<b>85082</b>					
	3601600C2	010	<b>85082</b>					
	3914952C1	010	...	...	010	<b>85976</b>	...	
	47902-24	010	...	...	010	<b>83121</b>	...	
	4C4Z-18124-N	010	<b>85957</b>	...		...	...	
	4C4Z-18125-DA	010	...	...	010	<b>85926</b>	...	
	503610C1	010	...	...	010	<b>83207</b>	<b>89407</b>	
	90044025	010	...	...	010	<b>83209</b>	<b>89414</b>	
	Intercambios Adicionales de E.O.	3541456C1	010	<b>85929</b>				
		3544766C1	010	<b>85930</b>				
3544768C1		010	<b>85926</b>					
3549100C1		010	<b>85926</b>					
3553628C1		010	<b>85927</b>					
3553628C2		010	<b>85927</b>					
3553628C3		010	<b>85927</b>					
3558089C1		010	<b>85925</b>					
3558089C2		010	<b>85925</b>					
3558989C1		010	<b>85925</b>					
3558989C2		010	<b>85925</b>					
3571713C1		-10	<b>85333</b>					
3596107C1		010	<b>85927</b>					
3596107C2		010	<b>85927</b>					
70334		-10	<b>85316 or 89426</b>					
AMS650102		010	<b>85001 or 89410</b>					
AMS650107		-10	<b>85316 or 89426</b>					
AMS650400		-10	<b>85033 or 89427</b>					
AMS650402		-10	<b>85311 or 89424</b>					
AMS650404		-1-	<b>85310 or 89423</b>					
AMS650405	010	<b>85023 or 89415</b>						
AMS650406	010	<b>85024 or 89416</b>						
AMS650408	-10	<b>85319 or 89428</b>						

**INTERNATIONAL (NAVISTAR) AMORTIGUADORES DE CABINA**

<b>- 91</b>	Dormitorios Navistar de 60" con Modelo Link Cabmate IHS60	1202-1043	010	<b>83025</b>
<b>97 -</b>	Eagle Pro-Sleeper	1202-0054	010	<b>83021</b>
	Modelos 1900A, 2000A - Fleetstar Convencional	480945C1	-1-	<b>83014</b>
		480945C2	-1-	<b>83014</b>
	Modelos con Número de E.O.	1201-1212	010	<b>83013</b>
		1201-1213	01-	<b>83005</b>
		2012768C1	010	<b>83013</b>
		2012769C2	01-	<b>83005</b>
		2023684C1	01-	<b>83015</b>
		2023685C1	01-	<b>83015</b>
		2025790C1	010	<b>83013</b>
		2500013C1	010	<b>83013</b>



**GUÍA DE APLICACIONES – CAMIONES, TRÁILERS Y AUTOBUSES**

Año	Modelo	# E.O.	Delantero		Trasero	
						
			Fleetline	GasSLX	Fleetline	GasSLX

**INTERNATIONAL (NAVISTAR) AMORTIGUADORES DE CABINA (Cont.)**

	Modelos con Número de E.O.	2507409C1	010	83052
		2507761C1	010	83052
		2507763C1	010	83052
		2507948C1	010	83054
		2508326C1	010	83021
		2508327C1	010	83025
		2590915C1	01-	83062
		2590916C1	01-	83062
		2597458C91	01-	83062
		2601488C91	01-	83062
		2602021C1	01-	83062
		3557165C1	010	83053
		3557166C1	010	83052
		3557167C3	010	83053
		3557169C1	010	83052
		3557169C2	010	83052
		3560649C1	010	83052
		3560649C2	010	83052
		3560705C2	010	83054
		AMS66160	010	83052
		AMS66161	010	83053
		OE14771	01-	83062
	Modelos con Suspensión Link Cab NPS90	1202-0054	010	83021
	Modelos con Suspensiones Link Cabmate con Número de E.O.	1201-1043	010	83025
		1201-1049	010	83025
		1201-9003	010	83052
		1201-9007	010	83054
		1201-9009	010	83054
		1201-9013	01-	83062
		1201-9014	01-	83062
		1201-9018	01-	83062
		1201-9021	01-	83062
		1202-0012	010	83023
		1202-0022	010	83046
		1202-0032	010	83016
		1202-0042	010	83025
		1202-0043	010	83032
		1202-0044	010	83025
		1202-0054	010	83021
		1202-1212	010	83013
		1202-1213	01-	83005
09 - 15	Modelos LoneStar con Dormitorio de Techo Alto de 72"	2595314C1	01-	83062
		2600491C91	01-	83062
11 - 13	Modelos Pro-Star con Dormitorio de Techo Alto de 56" o 72"	2593803C91	01-	83062
11 - 15	Modelos Pro-Star con Dormitorio de Techo Alto de 56" o 72"	2595314C1	01-	83062
	Tractos Convencionales Modelos S2500, S2600, 8100, 8200, & 8300 con Modelo Link Cabmate NAV80	1202-1043	010	83025
<b>Series 4000</b>				
	Cabinas Modelos HPV 4000 con Modelo Link Cabmate ITC 42	1201-9002	010	83052
- 15	DuraStar - Modelos 4300, 4400 - Tractos Convencionales con Número de E.O.	2509221C91	010	83054
	Tractos con Cabina Abatible Modelo Link Cabmate IHB-2P de 74", 84" o 88"	1202-0032	010	83016
	Tractos Convencionales con Modelo Link Cabmate IHC43	1201-0012	010	83023
		1202-0012	010	83023

## GUÍA DE APLICACIONES – CAMIONES, TRÁILERS Y AUTOBUSES

Año	Modelo	# E.O.	Delantero		Trasero	
			Fleetline	GasSLX	Fleetline	GasSLX

### INTERNATIONAL (NAVISTAR) AMORTIGUADORES DE CABINA (Cont.)

#### Series 5000 (Cont.)

09/94 -	Paystar - SBA Convencionales con Modelo Link Cabmate NP50 & NP50-A fabricados después de Agosto 1994	1201-1044	010		<b>83025</b>
		1202-1044	010		<b>83025</b>
09/96 -	Paystar - SFA Convencionales con Modelo Link Cabmate NP50 & NP50-A fabricados después de Agosto 1996	1201-1044	010		<b>83025</b>
		1202-1044	010		<b>83025</b>

#### Series 7000

	Modelos de Camión 7300, 7400 & 7500 con day cab o extended cabs con Link Cabmate Modelo IDC734	1201-9001	010		<b>83052</b>
	Modelos de Camión 7300, 7400 & 7500 con day cab o extended cabs con Link Cabmate Modelo IDC7345	1201-9008	010		<b>83054</b>
	Modelos de Camión 7600 con day cab o extended cabs con Link Cabmate Modelo IDC76	1201-9010	010		<b>83053</b>
- 14	Modelos WorkStar - 7000 con Número de E.O.	2509223C91	010		<b>83054</b>
- 15	Modelos WorkStar - 7000 con Número de E.O.	2509224C91	010		<b>83053</b>

#### Series 8000

	Modelos de Camión 8500 con day cab o extended cabs con Modelo Link Cabmate IDC85	1201-9008	010		<b>83054</b>
	Modelos de Camión 8600 con day cab o extended cabs con Modelos Link Cabmate IDC86	1201-9011	010		<b>83053</b>
04 - 09	Tractos TranStar - Modelos 8500, 8600 con Dormitorios de 36"	2509222C91	010		<b>83053</b>
- 13	Tractos TranStar - Modelos 8500, 8600 con Número de E.O.	2509223C91	010		<b>83054</b>

#### Series 9000









82 -	Cabinas Abatibles 9670, 9700 & 9800 de 89" & 110" con Modelos Link Cabmate NAV9876	1202-0054	010		<b>83021</b>
01/93-	Dormitorios Bentz de 48" & 60" en Tractos Convencionales Modelos 9000 con Modelo Link Cabmate IHS4860	1201-1044	010		<b>83025</b>
		1202-1044	010		<b>83025</b>
	Modelos 9200 con Número de E.O.	2023684C1	01-		<b>83015</b>
04 - 09	Modelos con Dormitorio de Techo Alto de 72"	1201-0254	010		<b>83051</b>
		2589922C1	010		<b>83051</b>
04 - 09	Modelos con Dormitorio de Techo Bajo de 51"	1201-0154	010		<b>83051</b>
		2585145C1	010		<b>83051</b>
03/97 -	Modelos Convencionales 9100 y 9200 con Modelos Link Cabmate ND92-A	1202-1043	010		<b>83025</b>
81 -	Tractos con Cabina Abatible 9670 de 89" o 110" con Modelos Link Cabmate IH967-A o IH97110	1202-0032	010		<b>83016</b>
89 -	Tractos con Cabina Abatible 9700 de 110" con Modelos Link Cabmate IH97110	1202-0032	010		<b>83016</b>
89 -	Tractos con Cabina Abatible 9700 de 89" con Modelos Link Cabmate IH9789	1202-0032	010		<b>83016</b>
	Tractos Convencionales 9300 & 9400 con Modelos Link Cabmate IHC93-A	1202-1043	010		<b>83025</b>
		2503529C1	010		<b>83025</b>

## ISUZU

### Aplicaciones Adicionales

95 -	Modelos FRR (Todos)	1-51630-219-1	-10	<b>83114</b>	...		...	...
		51630219	-10	<b>83114</b>	...		...	...
86 - 92	Modelos FSR	1-51630-168-1	-10	<b>G63610</b>	...		...	...
		1-51630-217-1	-10	<b>83114</b>	...		...	...
		51630168	-10	<b>G63610</b>	...		...	...
85	Modelos KS22 (Todos)	8-97083-027-0	-10	<b>G63616</b>	...		...	...
		9-51630-666-0		...	...	010	<b>85012</b>	<b>89413</b>
		9-51630-666-2		...	...	010	<b>85012</b>	<b>89413</b>
	Modelos con Número de E.O.	8-22064-231-0		...	...	-1-	<b>85324</b>	...
		8-22064-232-0		...	...	-1-	<b>85071</b>	...
		8-22064-233-0	-1-	<b>83136</b>	...		...	...
		8-22064-489-0		...	...	-1-	<b>85336</b>	...

## GUÍA DE APLICACIONES – CAMIONES, TRÁILERS Y AUTOBUSES

Año	Modelo	# E.O.	Delantero		Trasero	
						
						
			Fleetline	GasSLX	Fleetline	GasSLX

### ISUZU (Cont.)

#### Aplicaciones Adicionales (Cont.)

	Modelos con Número de E.O.	8-22064-804-0	- -	83136	...	...	...	...	
		8-22064-805-0	- -	83136	...	...	...	...	
		8-22064-806-0	- -	83136	...	...	...	...	
		8-22064-807-0	- -	83136	...	...	...	...	
		8-51630-666-0		...	...	0 0	85012	89413	...
		8972019600	- 0	G63616	...	...	...	...	
		8-97253-616-0	- 0	83515	...	...	...	...	
		8-97253-621-0	- 0	83515	...	...	...	...	
		8-97253-623-0	- 0	83515	...	...	...	...	
		898098-1250	- 0	83515	...	...	...	...	
		898098-1270	- 0	83515	...	...	...	...	
		94033786	- 0	83114	...	...	...	...	

#### Series ELF

	Modelos ELF 200 con Número de E.O.	8-98018780-0		...	...	0 0	83508	...
		8-98093-668-0		...	...	0 0	83508	...
		8-98197-653-0	0 0	83179	...	...	...	...
	Modelos ELF 300 con Número de E.O.	444329	- 0	83509	...	...	...	...
		5872000730	- 0	83509	...	...	...	...
		8-97253-605-0	- 0	83509	...	...	...	...
		8-98018780-0		...	...	0 0	83508	...
		8-98093-668-0		...	...	0 0	83508	...
	Modelos ELF 400, 500 o 600 con Número de E.O.	441133	- 0	83515	...	...	...	...
		5872001100	- 0	83515	...	...	...	...
		8-98098-058-0		...	...	0 0	83159	...
		8-98098-059-0		...	...	0 0	83159	...
		8-98098-125-0	- 0	83515	...	...	...	...
		8-98098-127-0	- 0	83515	...	...	...	...
		98098058		...	...	0 0	83159	...
		98098059		...	...	0 0	83159	...
98098127	- 0	83515	...	...	...	...		

#### Series FTR

05 - 09	Modelos FTR con Muelles Multihojas de 15000, 19000, 21000 lb	15174902		...	...	- -	85071	...
		88982686		...	...	- -	85071	...
05 - 09	Modelos FTR con Número de E.O.	15123676	- -	83136	...	...	...	...
		88982682	- -	83136	...	...	...	...
		8-98098-059-0		...	...	0 0	83159	...
		8-98098-127-0	- 0	83515	...	...	...	...
		98098059		...	...	0 0	83159	...
98098127	- 0	83515	...	...	...	...		





#### Series FVR

90 - 09	Modelos FVR con Muelles Multihojas de 15000, 19000, 21000 lb	88982686		...	...	- -	85071	...
00 - 09	Modelos FVR con Número de E.O.	15887728	- -	83136	...	...	...	...
		19152843	- -	83136	...	...	...	...
09	Modelos FVR con Suspensión Hendrickson HAS	12474915		...	...	0 0	83122	89406
		60670-005		...	...	0 0	83121	...

#### Series NPR

89 - 90	Flatlow Modelos NPR	51630647	- 0	G63616	...	...	...	...
		9-51630-647-1	- 0	G63616	...	...	...	...
89 - 92	Flatlow Modelos NPR	9-51630-666-0		...	...	0 0	85012	89413
		9-51630-666-2		...	...	0 0	85012	89413
86 - 95	Modelos NPR (NPC & NPN)	51630666		...	...	0 0	85012	89413
		8-94454-647-1	- 0	G63616	...	...	...	...
		8-94454-986-0	- 0	G63616	...	...	...	...

**GUÍA DE APLICACIONES – CAMIONES, TRÁILERS Y AUTOBUSES**

Año	Modelo	# E.O.	Delantero		Trasero	
						
			Fleetline	GasSLX	Fleetline	GasSLX

**ISUZU (Cont.)**

**Series NPR (Cont.)**

86 - 95	Modelos NPR (NPC & NPN)	8-94454-987-0	-10	G63616	...		...	...
		8-97083-029-0	-10	G63616	...		...	...
		94454986	-10	G63616	...		...	...
		9-51630-666-0		...	...	010	85012	89413
		9-51630-666-2		...	...	010	85012	89413
		97083029	-10	G63616	...		...	...
86 - 94	Modelos NPR (Todos)	9-51630-666-2		...	...	010	85012	89413
03 - 12	Modelos NPR, NPR-HD con Número de E.O.	8-97253-665-0		...	...	010	83159	...
		8-98098-058-0		...	...	010	83159	...
		8-98098-059-0		...	...	010	83159	...
		97253665		...	...	010	83159	...
		98098058		...	...	010	83159	...
		98098059		...	...	010	83159	...
86 - 12	Modelos NPR, NPR-HD con Suspensión de 11000 lb & 13000 lb	8-94454-987-0	-10	G63616	...		...	...
		8-97083-027-0	-10	G63616	...		...	...
		8-97083-029-0	-10	G63616	...		...	...
		8-97253-620-0	-10	83515	...		...	...
		8-98098-125-0	-10	83515	...		...	...
		94454987	-10	G63616	...		...	...
		97083027	-10	G63616	...		...	...
		97083029	-10	G63616	...		...	...
		97253620	-10	83515	...		...	...
		98098125	-10	83515	...		...	...
01 - 07	NPR, NPR-HD (Modelos a Diesel)	8-97253-651-2		...	...	010	83404	...
		97253651		...	...	010	83404	...
95 - 02	NPR, NPR-HD (Modelos a Gas & Diesel)	8-97253-664-0		...	...	010	83159	...
		97253664		...	...	010	83159	...
03 - 08	NPR, NPR-HD (Modelos a Gas)	8-97253-651-2		...	...	010	83404	...
		97253651		...	...	010	83404	...

**Series NQR**

03 - 12	Modelos NQR con Número de E.O.	8-97253-620-0	-10	83515	...		...	...
		8-97253-665-0		...	...	010	83159	...
		8-98098-059-0		...	...	010	83159	...
		8-98098-127-0	-10	83515	...		...	...
		97253620	-10	83515	...		...	...
		97253665		...	...	010	83159	...
		98098059		...	...	010	83159	...
		98098127	-10	83515	...		...	...
02	NQR (Diesel)	8-97253-664-0		...	...	010	83159	...
		97253664		...	...	010	83159	...
95 - 97	NQR (Diesel)	8-97253-664-0		...	...	010	83159	...
		97253664		...	...	010	83159	...

**Series NRR**

88 - 99	Modelos NRR (Todos)	1-51630-217-0	-10	83114	...		...	...
		1-51630-217-1	-10	83114	...		...	...
		1-51630-219-1	-10	83114	...		...	...
		51630217	-10	83114	...		...	...
02 - 12	Modelos NRR con Número de E.O.	8-97253-620-0	-10	83515	...		...	...
		8-97253-665-0		...	...	010	83159	...
		8-98098059-0		...	...	010	83159	...
		8-98098-127-0	-10	83515	...		...	...
		97253620	-10	83515	...		...	...
		97253665		...	...	010	83159	...
98098059		...	...	010	83159	...		

## GUÍA DE APLICACIONES – CAMIONES, TRÁILERS Y AUTOBUSES

Año	Modelo	# E.O.	Delantero		Trasero	
			Fleetline	GasSLX	Fleetline	GasSLX

### ISUZU (Cont.)

#### Series NRR (Cont.)

02 - 12	Modelos NRR con Número de E.O.	98098127	-10	<b>83515</b>	...	...	...
---------	--------------------------------	----------	-----	--------------	-----	-----	-----

### ITASCA

#### MotorHomes Clase A

<b>06</b>	MotorHomes Series Ellipse con Chasis Freightliner XC Amortiguador Trasero con Número de E.O.	141700131809					
		16-16736-000			010	<b>85029</b>	...
					010	<b>85029</b>	...
		Suspensión Delantera AS120	141700131810	010	<b>83160</b>	...	...
			16-16737-000	010	<b>83160</b>	...	...
			16-16874-000	010	<b>83160</b>	...	...
		Suspensión Delantera ZF - IFS con PBV de 23,000 lb o mayor	16-18103-000	-1-	<b>85900</b>	...	...
	481700000493	-1-	<b>85900</b>	...	...		
	Suspensión Trasera ADL200 de 20K	16-16873-000			010	<b>85029</b>	...
<b>04 - 06</b>	MotorHomes Series Horizon con Chasis Freightliner XC Amortiguador Trasero con Número de E.O.	141700131809					
		16-16736-000			010	<b>85029</b>	...
					010	<b>85029</b>	...
		Suspensión Delantera AS120	141700131810	010	<b>83160</b>	...	...
			16-16737-000	010	<b>83160</b>	...	...
			16-16874-000	010	<b>83160</b>	...	...
		Suspensión Delantera ZF - IFS con PBV de 23,000 lb o mayor	16-18103-000	-1-	<b>85900</b>	...	...
	481700000493	-1-	<b>85900</b>	...	...		
	Suspensión Trasera ADL200 de 20K	16-16873-000			010	<b>85029</b>	...
<b>02 - 06</b>	MotorHomes Series Meridian con Chasis Freightliner XC Amortiguador Trasero con Número de E.O.	141700131809					
		16-16736-000			010	<b>85029</b>	...
					010	<b>85029</b>	...
		Suspensión Delantera AS120	141700131810	010	<b>83160</b>	...	...
			16-16737-000	010	<b>83160</b>	...	...
			16-16874-000	010	<b>83160</b>	...	...
		Suspensión Delantera ZF - IFS con PBV de 23,000 lb o mayor	16-18103-000	-1-	<b>85900</b>	...	...
	481700000493	-1-	<b>85900</b>	...	...		
	Suspensión Trasera ADL200 de 20K	16-16873-000			010	<b>85029</b>	...

### JAY MADSEN

Intercambios Adicionales de E.O.	3166657	010	<b>85700</b>	...	...	...
	3192333	010	<b>85700</b>	...	...	...

### JIFFLOX

Dolly	CP-5222	010	<b>85315</b>	...	...	...
-------	---------	-----	--------------	-----	-----	-----

### JOHN DEERE

Modelos con Número de E.O.	4036892	010	<b>G63605</b>	...	...	...
----------------------------	---------	-----	---------------	-----	-----	-----

#### Chasis Motorhome





73 - 81	M & R - Chasis Motorhome 300, 400, 500	3638112	...	...	010	<b>G63183</b>	...
---------	--	---------	-----	-----	-----	---------------	-----

### KENWORTH

#### C500, C500B, C500K, C540 & C550

	Modelos con Eje Delantero Dual Steering y Suspensión Trasera Bogey con Barra de Torsión	K374-28				010	<b>85314</b>	<b>89425</b>
		K374-4				010	<b>85314</b>	<b>89425</b>
<b>- 09</b>	Modelos con Muelles Multihojas en Eje Delantero	B71-1003	010	<b>83312</b>	<b>89409</b>		...	...
		K374-3	010	<b>83312</b>	<b>89409</b>		...	...
		K374-33	010	<b>83312</b>	<b>89409</b>		...	...
<b>- 09</b>	Modelos con Muelles Taperleaf en Eje Delantero	B71-1002	010	<b>85001</b>	<b>89410</b>		...	...

**GUÍA DE APLICACIONES – CAMIONES, TRÁILERS Y AUTOBUSES**

Año	Modelo	# E.O.	Delantero		Trasero	
						
			Fleetline	GasSLX	Fleetline	GasSLX

**KENWORTH (Cont.)**

**C500, C500B, C500K, C540 & C550 (Cont.)**

<b>- 09</b>	Modelos con Muelles Taperleaf en Eje Delantero	K374-16	010	<b>85001</b>	<b>89410</b>		...	...
		K374-26	010	<b>85001</b>	<b>89410</b>		...	...
		K374-27	010	<b>85001</b>	<b>89410</b>		...	...
<b>01 -</b>	Modelos con Suspensión de Aire Trasera Air Glide 380 (AG380)	C71-1002		...	...	010	<b>85067</b>	<b>89451</b>
		C71-1016		...	...	010	<b>85067</b>	<b>89451</b>
	Todos los Modelos con Suspensión Air Glide 100 con 8 bolsas de aire, 4 amortiguadores necesarios	K374-29		...	...	-1-	<b>85310</b>	<b>89423</b>
		K374-32		...	...	-1-	<b>85310</b>	<b>89423</b>
	Todos los Modelos con Suspensión Air Glide 200 de 40,000 lb con 8 bolsas de aire, 4 amortiguadores necesarios	665903		...	...	-1-	<b>85900</b>	...
		665944		...	...	-1-	<b>85900</b>	...
		70701		...	...	-1-	<b>85900</b>	...
	Todos los Modelos con Suspensión Air Glide 200 de 46,000 lb con 8 bolsas de aire, 4 amortiguadores necesarios	665906		...	...	-1-	<b>85902</b>	...
		665945		...	...	-1-	<b>85902</b>	...









**K100, K100E, K125**

	Modelos con Eje Delantero con Desplazamiento hacia Atrás	665331	01-	<b>83353</b>	...		...	...
		K374-13	01-	<b>83353</b>	...		...	...
		K374-13-1	01-	<b>83353</b>	...		...	...
	Modelos con Eje Delantero Dual Steering y Suspensión Trasera Bogey con Barra de Torsión	K374-28		...	...	010	<b>85314</b>	<b>89425</b>
		K374-4		...	...	010	<b>85314</b>	<b>89425</b>
	Modelos con Muelles Multihojas en Eje Delantero	B71-1003	010	<b>83312</b>	<b>89409</b>		...	...
		K374-3	010	<b>83312</b>	<b>89409</b>		...	...
		K374-33	010	<b>83312</b>	<b>89409</b>		...	...
	Modelos con Muelles Taperleaf en Eje Delantero	B71-1002	010	<b>85001</b>	<b>89410</b>		...	...
		K374-16	010	<b>85001</b>	<b>89410</b>		...	...
		K374-26	010	<b>85001</b>	<b>89410</b>		...	...
		K374-27	010	<b>85001</b>	<b>89410</b>		...	...
	Todos los Modelos con Suspensión Air Glide 100 con 8 bolsas de aire, 4 amortiguadores necesarios	K374-29		...	...	-1-	<b>85310</b>	<b>89423</b>
		K374-32		...	...	-1-	<b>85310</b>	<b>89423</b>
	Todos los Modelos con Suspensión Air Glide 200 de 40,000 lb con 8 bolsas de aire, 4 amortiguadores necesarios	665903		...	...	-1-	<b>85900</b>	...
		665944		...	...	-1-	<b>85900</b>	...
		70701		...	...	-1-	<b>85900</b>	...
	Todos los Modelos con Suspensión Air Glide 200 de 46,000 lb con 8 bolsas de aire, 4 amortiguadores necesarios	665906		...	...	-1-	<b>85902</b>	...
		665945		...	...	-1-	<b>85902</b>	...

**K300, T300**

	K300 COE Medium Duty	665565	010	<b>85007</b>	<b>89412</b>		...	...
	Modelos con Amortiguador Woodhead (Número Estampado ACHB 966)	ACHB966		...	...	-1-	<b>83136</b>	...
	Modelos con Muelles Multihojas en Eje Delantero	B71-1003	010	<b>83312</b>	<b>89409</b>		...	...
		K374-3	010	<b>83312</b>	<b>89409</b>		...	...
		K374-33	010	<b>83312</b>	<b>89409</b>		...	...
	Modelos con Muelles Taperleaf en Eje Delantero	B71-1002	010	<b>85001</b>	<b>89410</b>		...	...
		K374-16	010	<b>85001</b>	<b>89410</b>		...	...
		K374-26	010	<b>85001</b>	<b>89410</b>		...	...
		K374-27	010	<b>85001</b>	<b>89410</b>		...	...
	Modelos con Número de E.O.	665617	010	<b>85031</b>	...		...	...
		B71-1000	010	<b>85031</b>	...		...	...
	Modelos con Suspensión de Aire Trasera Hendrickson	47902-19		...	...	010	<b>83123</b>	<b>89405</b>
	Modelos con Suspensión Reyco 102 o 79KB (Eje Motriz)	16725-01		...	...	010	<b>83221</b>	...
	Modelos con Suspensión Reyco 1209 o 1212 (Eje de Dirección)	19495-01	010	<b>83126</b>	<b>89440</b>		...	...

## GUÍA DE APLICACIONES – CAMIONES, TRÁILERS Y AUTOBUSES

Año	Modelo	# E.O.	Delanero		Trasero	
						
						
			Fleetline	GasSLX	Fleetline	GasSLX

### KENWORTH (Cont.)

#### K300, T300 (Cont.)

	Todos los Modelos con Suspensión Air Glide 100 con 8 bolsas de aire, 4 amortiguadores necesarios	K374-29	...	...	- -	85310	89423
		K374-32	...	...	- -	85310	89423
	Todos los Modelos con Suspensión Air Glide 200 de 40,000 lb con 8 bolsas de aire, 4 amortiguadores necesarios	665903	...	...	- -	85900	...
		665944	...	...	- -	85900	...
		70701	...	...	- -	85900	...
	Todos los Modelos con Suspensión Air Glide 200 de 46,000 lb con 8 bolsas de aire, 4 amortiguadores necesarios	665906	...	...	- -	85902	...
		665945	...	...	- -	85902	...

#### K370

13	Modelos con Suspensión de Muelles Reyco de 21,000 a 23,000 lb	19495-01	...	...	o o	83126	89440
		TK19679	...	...	o o	83126	89440
13	Modelos con Suspensión Trasera Reyco 79KB	16725-01	...	...	o o	83221	...

#### T170

08 - 13	Modelos con Eje Delanero de 8000 lb Dana	665617	o o	85031	...	...	...
08 - 13	Modelos con Suspensión Trasera Reyco 79KB	16725-01	o o	...	...	83221	...

#### T270, T370

10 - 14	Modelos con Eje Delanero de 10,000 a 12,000 lb	B71-6005	o o	85084	89460	...	...
- 09	Modelos con Eje Delanero de 12,000 lb	665617	o o	85031	...	...	...
10 - 14	Modelos con Eje Delanero de 13,200 a 14,600 lb	B71-6006	o o	85084	89460	...	...
10 - 14	Modelos con Eje Delanero de 8000 lb	B71-6004	o o	85084	89460	...	...
10 - 14	Modelos con Suspensión de Aire Trasera AG210L	C71-1011	...	...	- -	85069	89455
		C71-1017	...	...	- -	85069	89455
		C71-1017	...	...	- -	85069	89455
10 - 14	Modelos con Suspensión de Aire Trasera Hendrickson HAS - 230L	60670-008	...	...	o o	83123	89405
10 - 14	Modelos con Suspensión de Aire Trasera Hendrickson HAS - 400 (Estándar)	60670-005	...	...	o o	83121	...
10 - 13	Modelos con Suspensión de Muelles Reyco de 21,000 a 23,000 lb	19495-01	...	...	o o	83126	89440
10 - 14	Modelos con Suspensión Reyco 102 o 79KB (Eje Motriz)	16725-01	...	...	o o	83221	...



#### T400, T400B, T450B

	Modelos con Barra de Torsión Bogey (2 ejes traseros) y Suspensión de Aire KW (con 4 bolsas de aire)	K374-28	...	...	o o	85314	89425
		K374-4	...	...	o o	85314	89425
	Modelos con Muelles Multihojas en Eje Delanero	B71-1003	o o	83312	89409	...	...
		K374-3	o o	83312	89409	...	...
		K374-33	o o	83312	89409	...	...
	Modelos con Muelles Taperleaf en Eje Delanero	B71-1002	o o	85001	89410	...	...
		K374-16	o o	85001	89410	...	...
		K374-26	o o	85001	89410	...	...
		K374-27	o o	85001	89410	...	...
	Todos los Modelos con Suspensión Air Glide 100 con 8 bolsas de aire, 4 amortiguadores necesarios	K374-29	...	...	- -	85310	89423
		K374-32	...	...	- -	85310	89423
	Todos los Modelos con Suspensión Air Glide 200 de 40,000 lb con 8 bolsas de aire, 4 amortiguadores necesarios	665903	...	...	- -	85900	...
		665944	...	...	- -	85900	...
		70701	...	...	- -	85900	...
	Todos los Modelos con Suspensión Air Glide 200 de 46,000 lb con 8 bolsas de aire, 4 amortiguadores necesarios	665906	...	...	- -	85902	...
		665945	...	...	- -	85902	...

#### T440

12 -	Modelos con Suspensión de Aire Hendrickson Primaax 230, 460 y 690 (Altura desde 8-1/2" a 10")	60657-003	...	...	o o	85072	...
12 -	Modelos con Suspensión de Aire Hendrickson Primaax EX 232, 462 y 692 (Altura desde 8-1/2" a 10")	60657-003	...	...	o o	85072	...

**GUÍA DE APLICACIONES – CAMIONES, TRÁILERS Y AUTOBUSES**

Año	Modelo	# E.O.	Delantero			Trasero		
							Fleetline	GasSLX

**KENWORTH (Cont.)**

**T440 (Cont.)**

12 -	Modelos con Suspensión de Aire Hendrickson Primaax EX 262S o 522S (Altura de 10")	60665-011		...	...	010	85967	...
12 -	Modelos con Suspensión de Aire Neway AD-123 o AD-246 - con estampado en el amortiguador	90045068		...	...	-10	...	89441
		90045099		...	...	010	85906	89407
		90045132		...	...	010	85909	...
12 -	Modelos con Suspensión de Aire Trasera Air Glide 230 (AG230)	671656		...	...	01-	85985	...
		C71-1013		...	...	01-	85985	...
12 -	Modelos con Suspensión de Aire Trasera Air Glide 380 (AG380)	C71-1002		...	...	010	85067	89451
		C71-1016		...	...	010	85067	89451
12 -	Modelos con Suspensión de Aire Trasera Air Glide 400 (AG400)	671962		...	...	01-	85936	89456
		C71-1014		...	...	01-	85936	89456
12 -	Modelos con Suspensión de Aire Trasera Air Glide 460 (AG460)	671963		...	...	01-	85937	...
12 -	Modelos con Suspensión de Aire Trasera Hendrickson HAS - 230	60670-005		...	...	010	83121	...
- 12	Modelos con Suspensión Delantera de Muelles de 12000 lb a 20000 lb	665858	010	85070	89459		...	...
- 14	Modelos con Suspensión Delantera de Muelles de 12000 lb a 20000 lb	B71-1001	010	85070	89459		...	...
12 -	Modelos con Suspensión Hendrickson HMX 400/460 Haulmax - con Silla de Montaje de 16.5" - con Silla de Montaje de 17.5" o 18.5"	60680-004		...	...	01-	83143	...
		60680-005		...	...	01-	83142	...
		665174		...	...	010	85060	...
12 -	Modelos con Suspensión Trasera Reyco 79KB	16725-01		...	...	010	83221	...

**T470**









10 - 13	Modelos con Suspensión de Aire Hendrickson Primaax 230, 460 y 690 (Altura desde 8-1/2" a 10")	60657-003		...	...	010	85072	...
10 - 13	Modelos con Suspensión de Aire Hendrickson Primaax EX 232, 462 y 692 (Altura desde 8-1/2" a 10")	60657-003		...	...	010	85072	...
10 - 13	Modelos con Suspensión de Aire Neway AD-123 o AD-246 - con estampado en el amortiguador	90045068		...	...	-10	...	89441
		90045099		...	...	010	85906	89407
		90045132		...	...	010	85909	...
10 -	Modelos con Suspensión de Aire Trasera Air Glide 230 (AG230)	671656		...	...	01-	85985	...
		C71-1013		...	...	01-	85985	...
10 - 13	Modelos con Suspensión de Aire Trasera Air Glide 380 (AG380)	C71-1002		...	...	010	85067	89451
		C71-1016		...	...	010	85067	89451
10 - 13	Modelos con Suspensión de Aire Trasera Air Glide 400 (AG400)	671962		...	...	01-	85936	89456
		C71-1014		...	...	01-	85936	89456
10 - 13	Modelos con Suspensión de Aire Trasera Air Glide 460 (AG460)	671963		...	...	01-	85937	...
10 - 13	Modelos con Suspensión de Aire Trasera Hendrickson HAS - 230	60670-005		...	...	010	83121	...
10 -	Modelos con Suspensión Delantera de Muelles de 12000 lb a 20000 lb	665858	010	85070	89459		...	...
		B71-1001	010	85070	89459		...	...
10 - 13	Modelos con Suspensión Hendrickson HMX 400/460 Haulmax - con Silla de Montaje de 16.5" - con Silla de Montaje de 17.5" o 18.5"	60680-004		...	...	01-	83143	...
		60680-005		...	...	01-	83142	...
		665174		...	...	010	85060	...
10 - 13	Modelos con Suspensión Trasera Reyco 79KB	16725-01		...	...	010	83221	...

**T600, T600A, T600B, T602**

06 -	Modelos con Eje Delantero de 13,000 lb	665858	010	85070	89459		...	...
------	--	--------	-----	-------	-------	--	-----	-----



## GUÍA DE APLICACIONES – CAMIONES, TRÁILERS Y AUTOBUSES

Año	Modelo	# E.O.	Delantero		Trasero	
						
						
			Fleetline	GasSLX	Fleetline	GasSLX

### KENWORTH (Cont.)

#### T600, T600A, T600B, T602 (Cont.)

06 -	Modelos con Eje Delantero de 13,000 lb	B71-1001	OIO	85070	89459	...	...
	Modelos con Muelles Multihojas en Eje Delantero	B71-1003	OIO	83312	89409	...	...
		K374-3	OIO	83312	89409	...	...
		K374-33	OIO	83312	89409	...	...
	Modelos con Muelles Taperleaf en Eje Delantero	B71-1002	OIO	85001	89410	...	...
		K374-16	OIO	85001	89410	...	...
		K374-26	OIO	85001	89410	...	...
		K374-27	OIO	85001	89410	...	...
02 - 13	Modelos con Suspensión de Aire Trasera Air Glide 380 (AG380)	C71-1002		...	...	OIO	85067 89451
		C71-1016		...	...	OIO	85067 89451
05 - 13	Modelos con Suspensión de Aire Trasera Air Glide 400 (AG400)	671962		...	...	OI-	85936 89456
		C71-1014		...	...	OI-	85936 89456
05 - 13	Modelos con Suspensión de Aire Trasera Air Glide 460 (AG460)	671963		...	...	OI-	85937 ...
	Modelos con Suspensión de Aire Trasera Hendrickson	47902-19		...	...	OIO	83123 89405
		47902-24		...	...	OIO	83121 ...
	Modelos con Suspensión Reyco 102 o 79KB (Eje Motriz)	16725-01		...	...	OIO	83221 ...
	Modelos con Suspensión Reyco 1209 o 1212 (Eje de Dirección)	19495-01	OIO	83126	89440		...
	Todos los Modelos con Suspensión Air Glide 100 con 8 bolsas de aire, 4 amortiguadores necesarios	K374-29		...	...	-I-	85310 89423
		K374-32		...	...	-I-	85310 89423
	Todos los Modelos con Suspensión Air Glide 200 de 40,000 lb con 8 bolsas de aire, 4 amortiguadores necesarios	665903		...	...	-I-	85900 ...
		665944		...	...	-I-	85900 ...
		70701		...	...	-I-	85900 ...
	Todos los Modelos con Suspensión Air Glide 200 de 46,000 lb con 8 bolsas de aire, 4 amortiguadores necesarios	665906		...	...	-I-	85902 ...
		665945		...	...	-I-	85902 ...

#### T660

06 -	Modelos con Eje Delantero de 12000 o 13200 lb	665858	OIO	85070	89459	...	...
		B71-1001	OIO	85070	89459	...	...
06 -	Modelos con Suspensión de Aire Trasera Air Glide 230 (AG230)	671656		...	...	OI-	85985 ...
		C71-1013		...	...	OI-	85985 ...
06 - 13	Modelos con Suspensión de Aire Trasera Air Glide 380 (AG380)	C71-1002		...	...	OIO	85067 89451
		C71-1016		...	...	OIO	85067 89451
08 - 13	Modelos con Suspensión de Muelles de 40,000 lb	C71-1011		...	...	-I-	85069 89455
		C71-1017		...	...	-I-	85069 89455
	Remolque con Número de E.O.	K374-36	OIO	...	89432		...



#### T680

13 - 14	Modelos con Eje Delantero de 10,000 a 13,200 lb	B71-6005	OIO	85084	89460	...	...
14 - 15	Modelos con Eje Delantero de 10,000 a 13,200 lb	B71-6019	OIO	85989	...	...	...
13 - 15	Modelos con Número de E.O.	B71-6012	OIO	85119	...	...	...
13 - 14	Modelos con Suspensión de Aire Trasera Air Glide 380 (AG380)	C71-1002		...	...	OIO	85067 89451
		C71-1016		...	...	OIO	85067 89451
13 - 14	Modelos con Suspensión de Aire Trasera Air Glide 400 (AG400)	671962		...	...	OI-	85936 89456
		C71-1014		...	...	OI-	85936 89456
13 - 14	Modelos con Suspensión de Aire Trasera Air Glide 460 (AG460)	671963		...	...	OI-	85937 ...

#### T700

11 -	Modelos con Eje Delantero de 13,000 lb	665858	OIO	85070	89459	...	...
		B71-1001	OIO	85070	89459	...	...

**GUÍA DE APLICACIONES – CAMIONES, TRÁILERS Y AUTOBUSES**

Año	Modelo	# E.O.	Delantero		Trasero	
						
			Fleetline	GasSLX	Fleetline	GasSLX

**KENWORTH (Cont.)**

**T700 (Cont.)**

11 -	Modelos con Suspensión de Aire Trasera Air Glide 230 (AG230)	671656		...	...	01-	85985	...
		C71-1013		...	...	01-	85985	...
11 - 13	Modelos con Suspensión de Aire Trasera Air Glide 380 (AG380)	C71-1002		...	...	010	85067	89451
		C71-1016		...	...	010	85067	89451
11 - 13	Modelos con Suspensión de Aire Trasera Air Glide 400 (AG400)	671962		...	...	01-	85936	89456
		C71-1014		...	...	01-	85936	89456









**T800, T800B, T800B(8x4), T800SH, T800H, T800W**

	Modelos con Barra de Torsión Bogey (2 ejes traseros) y Suspensión de Aire KW (con 4 bolsas de aire)	K374-28		...	...	010	85314	89425
		K374-4		...	...	010	85314	89425
05 - 14	Modelos con Eje Delantero de 18,000 a 20,000 lb	665858	010	85070	89459		...	...
		B71-1001	010	85070	89459		...	...
	Modelos con Muelles Multihojas en Eje Delantero	B71-1003	010	83312	89409		...	...
		K374-3	010	83312	89409		...	...
		K374-33	010	83312	89409		...	...
	Modelos con Muelles Taperleaf en Eje Delantero	B71-1002	010	85001	89410		...	...
		K374-16	010	85001	89410		...	...
		K374-26	010	85001	89410		...	...
		K374-27	010	85001	89410		...	...
10 - 14	Modelos con Suspensión de Aire Hendrickson Primaax EX 232, 462 y 692 (Altura desde 8-1/2" a 10")	60657-003		...	...	010	85072	...
06 -	Modelos con Suspensión de Aire Trasera Air Glide 230 (AG230)	671656		...	...	01-	85985	...
		C71-1013		...	...	01-	85985	...
01 - 13	Modelos con Suspensión de Aire Trasera Air Glide 380 (AG380)	C71-1002		...	...	010	85067	89451
		C71-1016		...	...	010	85067	89451
05 - 13	Modelos con Suspensión de Aire Trasera Air Glide 400 (AG400)	671962		...	...	01-	85936	89456
		C71-1014		...	...	01-	85936	89456
05 - 13	Modelos con Suspensión de Aire Trasera Air Glide 460 (AG460)	671963		...	...	01-	85937	...
	Modelos con Suspensión de Aire Trasera Hendrickson	47902-19		...	...	010	83123	89405
		47902-24		...	...	010	83121	...
	Modelos con Suspensión de Aire Trasera Neway	90044089		...	...	010	83124	89407
	Modelos con Suspensión de Aire Trasera Neway (AD123-, AD246- )	90045132		...	...	010	85909	...
	Modelos con Suspensión Reyco 102 o 79KB (Eje Motriz)	16725-01		...	...	010	83221	...
	Modelos con Suspensión Reyco 1209 o 1212 (Eje de Dirección)	19495-01	010	83126	89440		...	...
- 14	Modelos con Suspensión Trasera Chalmers de 40,000 lb	665174		...	...	010	85060	...
- 14	Modelos con Suspensión Trasera Neway ADZ	471700004423		...	...	010	85109	...
		90045605		...	...	010	85109	...
	Todos los Modelos con Suspensión Air Glide 100 con 8 bolsas de aire, 4 amortiguadores necesarios	K374-29		...	...	-1-	85310	89423
		K374-32		...	...	-1-	85310	89423
	Todos los Modelos con Suspensión Air Glide 200 de 40,000 lb con 8 bolsas de aire, 4 amortiguadores necesarios	665903		...	...	-1-	85900	...
		665944		...	...	-1-	85900	...
		70701		...	...	-1-	85900	...
	Todos los Modelos con Suspensión Air Glide 200 de 46,000 lb con 8 bolsas de aire, 4 amortiguadores necesarios	665906		...	...	-1-	85902	...
		665945		...	...	-1-	85902	...

**T880**

14 - 15	Modelos con Eje Delantero de 10,000 a 13,200 lb	B71-6019	010	85989	...		...	...
14 - 15	Modelos con Eje Delantero de 20,000 lb	B71-6020	010	85989	...		...	...

## GUÍA DE APLICACIONES – CAMIONES, TRÁILERS Y AUTOBUSES

Año	Modelo	# E.O.	Delantero		Trasero	
						
						
			Fleetline	GasSLX	Fleetline	GasSLX

### KENWORTH (Cont.)

#### T880 (Cont.)

	Modelos con Número de E.O.	C71-1015 C71-1015 PLUS C71-1015A		...	...	0 -	<b>85937</b>	...
				...	...	0 -	<b>85937</b>	...
				...	...	0 -	<b>85937</b>	...
<b>14 - 15</b>	Modelos con Número de E.O.	B71-6012	0 0	<b>85119</b>	...		...	...
	Modelos con Suspensión Delantera de Muelles de 12000 lb a 20000 lb	665858	0 0	<b>85070</b>	89459		...	...
	- con Silla de Montaje de 16.5"	B71-1001	0 0	<b>85070</b>	89459		...	...
	- con Silla de Montaje de 17.5" o 18.5"	60680-004		...	...	0 -	<b>83143</b>	...
		60680-005		...	...	0 -	<b>83142</b>	...





#### T2000

<b>06 - 10</b>	Modelos con Eje Delantero de 13,000 lb	665858 B71-1001	0 0	<b>85070</b>	89459		...	...
			0 0	<b>85070</b>	89459		...	...
	Modelos con Muelles Multihojas en Eje Delantero	B71-1003 K374-3 K374-33	0 0	<b>83312</b>	89409		...	...
			0 0	<b>83312</b>	89409		...	...
			0 0	<b>83312</b>	89409		...	...
	Modelos con Muelles Taperleaf en Eje Delantero	B71-1002 K374-16 K374-26 K374-27	0 0	<b>85001</b>	89410		...	...
			0 0	<b>85001</b>	89410		...	...
			0 0	<b>85001</b>	89410		...	...
			0 0	<b>85001</b>	89410		...	...
<b>02 - 10</b>	Modelos con Suspensión de Aire Trasera Air Glide 380 (AG380)	C71-1002		...	...	0 0	<b>85067</b>	89451
		C71-1016		...	...	0 0	<b>85067</b>	89451
<b>05 - 10</b>	Modelos con Suspensión de Aire Trasera Air Glide 400 (AG400)	671962		...	...	0 -	<b>85936</b>	89456
		C71-1014		...	...	0 -	<b>85936</b>	89456
<b>05 - 10</b>	Modelos con Suspensión de Aire Trasera Air Glide 460 (AG460)	671963		...	...	0 -	<b>85937</b>	...
	Todos los Modelos con Suspensión Air Glide 100 con 8 bolsas de aire, 4 amortiguadores necesarios	K374-29 K374-32		...	...	- -	<b>85310</b>	89423
				...	...	- -	<b>85310</b>	89423
	Todos los Modelos con Suspensión Air Glide 200 de 40,000 lb con 8 bolsas de aire, 4 amortiguadores necesarios	665903 665944 70701		...	...	- -	<b>85900</b>	...
				...	...	- -	<b>85900</b>	...
				...	...	- -	<b>85902</b>	...
	Todos los Modelos con Suspensión Air Glide 200 de 46,000 lb con 8 bolsas de aire, 4 amortiguadores necesarios	665906 665945		...	...	- -	<b>85902</b>	...
				...	...	- -	<b>85902</b>	...

#### W900, W900B, W900L, W900S

	Modelos con Barra de Torsión Bogey (2 ejes traseros) y Suspensión de Aire KW (con 4 bolsas de aire)	K374-28 K374-4		...	...	0 0	<b>85314</b>	89425
				...	...	0 0	<b>85314</b>	89425
<b>05 -</b>	Modelos con Eje Delantero de 12000 o 13200 lb	665858 B71-1001	0 0	<b>85070</b>	89459		...	...
			0 0	<b>85070</b>	89459		...	...
	Modelos con Muelles Multihojas en Eje Delantero	B71-1003 K374-3 K374-33	0 0	<b>83312</b>	89409		...	...
			0 0	<b>83312</b>	89409		...	...
			0 0	<b>83312</b>	89409		...	...
	Modelos con Muelles Taperleaf en Eje Delantero	B71-1002 K374-16 K374-26 K374-27	0 0	<b>85001</b>	89410		...	...
			0 0	<b>85001</b>	89410		...	...
			0 0	<b>85001</b>	89410		...	...
			0 0	<b>85001</b>	89410		...	...
<b>06 -</b>	Modelos con Suspensión de Aire Trasera Air Glide 230 (AG230)	671656 C71-1013		...	...	0 -	<b>85985</b>	...
				...	...	0 -	<b>85985</b>	...
<b>01 - 13</b>	Modelos con Suspensión de Aire Trasera Air Glide 380 (AG380)	C71-1002		...	...	0 0	<b>85067</b>	89451
		C71-1016		...	...	0 0	<b>85067</b>	89451
<b>05 - 13</b>	Modelos con Suspensión de Aire Trasera Air Glide 400 (AG400)	671962		...	...	0 -	<b>85936</b>	89456

**GUÍA DE APLICACIONES – CAMIONES, TRÁILERS Y AUTOBUSES**

Año	Modelo	# E.O.	Delantero		Trasero	
						
			Fleetline	GasSLX	Fleetline	GasSLX

**KENWORTH (Cont.)**





**W900, W900B, W900L, W900S (Cont.)**

05 - 13	Modelos con Suspensión de Aire Trasera Air Glide 400 (AG400)	C71-1014		...	...	01-	85936	89456
05 - 13	Modelos con Suspensión de Aire Trasera Air Glide 460 (AG460)	671963		...	...	01-	85937	...
	Modelos con Suspensión de Aire Trasera Hendrickson	47902-19		...	...	010	83123	89405
		47902-24		...	...	010	83121	...
10	Modelos con Suspensión de Aire Trasera Neway de 46000 lb	90045132		...	...	010	85909	...
	Modelos con Suspensión Reyco 102 o 79KB (Eje Motriz)	16725-01		...	...	010	83221	...
	Modelos con Suspensión Reyco 1209 o 1212 (Eje de Dirección)	19495-01	010	83126	89440		...	...
	Remolque con Número de E.O.	K374-36	010	...	89432		...	...
	Todos los Modelos con Suspensión Air Glide 100 con 8 bolsas de aire, 4 amortiguadores necesarios	K374-29		...	...	-1-	85310	89423
		K374-32		...	...	-1-	85310	89423
	Todos los Modelos con Suspensión Air Glide 200 de 40,000 lb con 8 bolsas de aire, 4 amortiguadores necesarios	665903		...	...	-1-	85900	...
		665944		...	...	-1-	85900	...
		70701		...	...	-1-	85900	...
	Todos los Modelos con Suspensión Air Glide 200 de 46,000 lb con 8 bolsas de aire, 4 amortiguadores necesarios	665906		...	...	-1-	85902	...
		665945		...	...	-1-	85902	...

**Intercambios Adicionales de E.O.**

Amortiguador TruckMaster con Número Estampado	665632	010	85013	89414		...	...
	665633		...	...	-10	85033	89427
	665783		...	...	010	83123	89405
	665784		...	...	010	83122	89406
	665785		...	...	010	83137	...
	665844		...	...	-1-	85069	89455
	665918		...	...	-1-	85900	...
	665926		...	...	010	85047	89435
	665927	010	85901	...		...	...
	665928	010	85062	89408		...	...
	665930	010	85001	89410		...	...
	665931	010	83312	89409		...	...
	665932	010	85012	89413		...	...
	665950		...	...	-1-	85902	...
	671052	010	85070	89459		...	...
	671654		...	...	01-	85936	89456
	671699		...	...	01-	85937	...
	671794		...	...	010	85067	89451
	680237	010	85303 or 89422			...	...
	680239		...	...	-1-	85310	89423
	680240		...	...	010	85302	89420
	680242		...	...	010	85308	89422
	680253		...	...	010	85314	89425
	680261	010	85062	89408		...	...
	680279	010	83209	89414		...	...
	680280		...	...	010	85906	89407
	680281		...	...	010	85003	89411
	680283	01-	83353	...		...	...
	680303		...	...	010	85007	89412
	680425	010	85320	89429		...	...
	680435		...	...	-10	85033	89427
	680473		...	...	-10	85319	89428
680586		...	...	-10	85311	89424	
Modelos con Suspensión de Aire Hendrickson Primaax EX 262 o 522 (Altura de 10")	60665-013		...	...	010	85965	...

**GUÍA DE APLICACIONES – CAMIONES, TRÁILERS Y AUTOBUSES**





Año	Modelo	# E.O.	Delantero		Trasero	
						
			Fleetline	GasSLX	Fleetline	GasSLX

**KENWORTH (Cont.)**

**Intercambios Adicionales de E.O. (Cont.)**

	Modelos con Suspensión de Aire Hendrickson Primaax EX 262S o 522S (Altura de 10")	60665-011		...	...	010	<b>85967</b>	...
	Modelos con Suspensión de Aire Trasera Hendrickson Primaax 260 o 520 (Altura de 10" - Frenos de Discos Únicamente)	60665-013		...	...	010	<b>85965</b>	...
		60665-015		...	...	010	<b>85966</b>	...
	Número de Estampado de Amortiguador EO PLUS	02-02736PLUS	010	<b>85302</b>	<b>89420</b>		...	...
		02-02737PLUS	010	<b>85062</b>	<b>89408</b>		...	...
		02-02738PLUS	010	<b>85012</b>	<b>89413</b>		...	...
		02-02739PLUS	010	<b>85013</b>	<b>89414</b>		...	...
		03-04176PLUS		...	...	010	<b>85308</b>	<b>89422</b>
		03-06084PLUS		...	...	-10	<b>85033</b>	<b>89427</b>
		03-07421PLUS		...	...	-10	<b>85311</b>	<b>89424</b>
		03-07423PLUS		...	...	-10	<b>85033</b>	<b>89427</b>
		10-12032-002PLUS	010	<b>85320</b>	<b>89429</b>		...	...
		10-12542-000PLUS	010	<b>85901</b>	...		...	...
		16-13947-000PLUS		...	...	-10	<b>85319</b>	<b>89428</b>
		2018987C1PLUS		...	...	010	<b>85003</b>	<b>89411</b>
		47902-13PLUS		...	...	010	<b>83122</b>	<b>89406</b>
		60670-005PLUS		...	...	010	<b>83121</b>	...
		60670-008PLUS		...	...	010	<b>83123</b>	<b>89405</b>
		665565PLUS		...	...	010	<b>85007</b>	<b>89412</b>
		671962PLUS		...	...	01-	<b>85936</b>	<b>89456</b>
		70701PLUS		...	...	-1-	<b>85900</b>	...
		8086053PLUS		...	...	010	<b>85047</b>	<b>89435</b>
		90044025PLUS	010	<b>83209</b>	<b>89414</b>		...	...
		90044089PLUS		...	...	010	<b>83124</b>	<b>89407</b>
		B71-6015	010	<b>85012</b>	<b>89413</b>		...	...
		C71-1002PLUS		...	...	010	<b>85067</b>	<b>89451</b>
	C71-1011PLUS		...	...	-1-	<b>85069</b>	<b>89455</b>	
	K374-26PLUS	010	<b>85001</b>	<b>89410</b>		...	...	
	K374-28PLUS		...	...	010	<b>85314</b>	<b>89425</b>	
	K374-29PLUS		...	...	-1-	<b>85310</b>	<b>89423</b>	
	K374-33PLUS	010	<b>83312</b>	<b>89409</b>		...	...	
	Modelos con Muelles Multihojas en Eje Delantero	K374-14	010	<b>83312</b>	<b>89409</b>		...	...
		K374-5	010	<b>83312</b>	<b>89409</b>		...	...
	Modelos con Muelles Taperleaf en Eje Delantero	K374-11	010	<b>85001</b>	<b>89410</b>		...	...
	Modelos con Número de E.O.	665453	010	<b>85001</b>	<b>89410</b>		...	...
		665670	010	<b>85001</b>	<b>89410</b>		...	...
		665680	010	<b>83312</b>	<b>89409</b>		...	...
		665788		...	...	010	<b>85000</b>	<b>89436</b>
		665828		...	...	010	<b>85067</b>	<b>89451</b>
		675041	01-	<b>83353</b>	...		...	...
		675122	010	<b>85001</b>	<b>89410</b>		...	...
		680241		...	...	-10	<b>85311</b>	<b>89424</b>
		680475		...	...	010	<b>85314</b>	<b>89425</b>
		680476		...	...	-1-	<b>85310</b>	<b>89423</b>
		680486		...	...	-1-	<b>85310</b>	<b>89423</b>
		680586		...	...	-10	<b>85311</b>	<b>89424</b>
		B71-6000	010	<b>85920</b>	...		...	...
		B71-6002	010	<b>85012</b>	<b>89413</b>		...	...
		B71-6003	010	<b>85029</b>	...		...	...
		B71-6007	010	<b>85062</b>	<b>89408</b>		...	...
		B71-6008	010	<b>83312</b>	<b>89409</b>		...	...
		B71-6010	010	<b>85023 or 89415</b>			...	...
		B71-6011	010	<b>85062</b>	<b>89408</b>		...	...

**GUÍA DE APLICACIONES – CAMIONES, TRÁILERS Y AUTOBUSES**

Año	Modelo	# E.O.	Delantero		Trasero	
						
			Fleetline	GasSLX	Fleetline	GasSLX

**KENWORTH (Cont.)**

**Intercambios Adicionales de E.O. (Cont.)**

Modelos con Número de E.O.	B71-6013	010	85012	89413		...	...
	B71-6016	010	85012	89413		...	...
	B71-6017	010	85910	...		...	...
	B71-6018	010	85012	89413		...	...
	C71-6003		...	...	-10	85988	...
	C71-6004		...	...	-10	85343	...
	C71-6005		...	...	-1-	85069	89455
	K374-15	01-	83353	...		...	...
	K374-7		...	...	-1-	85310	89423
	K374-9		...	...	-1-	85310	89423
	K374-C31	010	83312	89409		...	...
	R71-6006	010	83063				
	R71-6007	010	83008				
	R71-6008	010	83035				
	S-20126		...	...	010	85323	89436
Todos los Modelos con Suspensión Air Glide 100 con 8 bolsas de aire, 4 amortiguadores necesarios	K374-C7		...	...	-1-	85310	89423
Intercambios Adicionales de E.O.	3166657	010	85700				
	665092	010	83312 or 89409				
	665118	010	83312 or 89409				
	K374-3-1	010	83312 or 89409				

**KENWORTH AMORTIGUADORES DE CABINA**

**C-500B**

Modelos con Suspensión de Aire Link Cabmate KWB500	1202-0044	010	83025				
--	-----------	-----	-------	--	--	--	--

**Models COE**

Modelos con Suspensión de Aire Link Cabmate KW1102-B (Exc. Cabinas sin Dormitorio)	1202-0032	010	83016				
Modelos con Suspensión de Aire Link Cabmate KWE90112-A	1202-0032	010	83016				
Modelos E de 90" y 112" con Suspensión de Aire Link Cabmate KWE90112-B	1202K064	010	83024				
	R71-1005	010	83024				

**Series Aerocab**

Modelos con Dormitorios de 38" Link Cabmate KWK1T03 o KWCSA 01-06	1202-1264	010	83031				
Modelos con Dormitorios de 62" y 74" con Número de E.O.	1202-1164	010	83031				
Modelos con Dormitorios de 72" con Modelos Link Cabmate KWK1T02 o KWCSA 01-06	1202-1065	010	83002				
Modelos con Dormitorios de 86" con Número de E.O.	1202-1286	010	83056				
	1202K286	010	83056				
	T71-1003	010	83056				

**T400A**

- 05/92	Modelos con Suspensión de Aire Link Cabmate KWB400-A	1202-0012	010	83023				
06/92 -	Modelos con Suspensión de Aire Link Cabmate KWB689-A con soporte trasero de cabina Kenworth NP K235-1646	1202-0012	010	83023				
05/92 -	Modelos con Suspensión de Aire Link Cabmate KWB689-B o KWB689-C	1201-1043	010	83025				
06/92 -	Modelos con Suspensión de Aire Link Cabmate KWB689-B o KWB689-C	1202-1043	010	83025				

**T440**

Modelos con Link Cabmate KWB689-D y Travesaños para Servicio Severo	1201-1046	010	83049				
	1202-1046	010	83049				
	1202K046	010	83049				
	R71-1004	010	83049				

**T450**

Modelos con Link Cabmate KWB689-D y Travesaños para Servicio Severo	1202K046	010	83049				
---	----------	-----	-------	--	--	--	--

## GUÍA DE APLICACIONES – CAMIONES, TRÁILERS Y AUTOBUSES

Año	Modelo	# E.O.	Delantero		Trasero	
			Fleetline	GasSLX	Fleetline	GasSLX

### KENWORTH AMORTIGUADORES DE CABINA (Cont.)

#### T450 (Cont.)

	Modelos con Link Cabmate KWB689-D y Travesaños para Servicio Severo	R71-1004	010	83049
- 05/92	Modelos con Suspensión de Aire Link Cabmate KWB400-A	1202-0012	010	83023
06/92 -	Modelos con Suspensión de Aire Link Cabmate KWB689-A con soporte trasero de cabina Kenworth NP K235-1646	1202-0012	010	83023
05/92 -	Modelos con Suspensión de Aire Link Cabmate KWB689-B o KWB689-C	1201-1043	010	83025
06/92 -	Modelos con Suspensión de Aire Link Cabmate KWB689-B o KWB689-C	1202-1043	010	83025

#### T600

	Modelos con Suspensión de Aire Link Cabmate KWMC642	1202-0054	010	83021
--	---	-----------	-----	-------

#### T600A

	Modelos con Link Cabmate KWB689-D y Travesaños para Servicio Severo	1202K046	010	83049
		R71-1004	010	83049
	Modelos con Suspensión de Aire Link Cabmate KWB689-A y montaje trasero de cabina Kenworth NP K235-1436 o K235-1488	1202-0012	010	83023
	Modelos con Suspensión de Aire Link Cabmate KWB689-B o KWB689-C y montaje trasero de cabina Kenworth NP K235-1436 o K235-1488	1201-1043	010	83025
		1202-1043	010	83025

#### T660

06 - 10	Modelos con Suspensión Link Cab	1202-1065	010	83002
---------	---------------------------------	-----------	-----	-------

#### T700

11 -	Modelos con Cabina Dormitorio Extendida	R71-1005	010	83024
------	---	----------	-----	-------

#### T800 / T800A

	Modelos con Link Cabmate KWB689-D y Travesaños para Servicio Severo	1202K046	010	83049
- 14	Modelos con Link Cabmate KWB689-D y Travesaños para Servicio Severo	R71-1004	010	83049
	Modelos con Suspensión de Aire Link Cabmate KWB689-A y montaje trasero de cabina Kenworth NP K235-1436 o K235-1488	1202-0012	010	83023
	Modelos con Suspensión de Aire Link Cabmate KWB689-B o KWB689-C y montaje trasero de cabina Kenworth NP K235-1436 o K235-1488	1201-1043	010	83025
		1202-1043	010	83025
	Modelos con Suspensión de Aire Link Cabmate KWMC642	1202-0054	010	83021
- 12	Modelos con Suspensión Link Cab	1202-1046	010	83049

#### T2000

- 09	Modelos con Suspensión de Aire Link Cabmate KWT2000-A	1202-1064	010	83024
04/99 -	Modelos con Suspensión de Aire Link Cabmate KWT2000-A	1202K064	010	83024
		R71-1005	010	83024
- 06/98	Modelos con Suspensión de Cabina PowerPacker anterior al 28/06/98	96027-10545	010	83011
07/98 -	Modelos con Suspensión de Cabina PowerPacker posterior al 28/06/98	PP2582870	010	83012



#### W-900 / W-900B

	Modelos con Link Cabmate KWB689-D y Travesaños para Servicio Severo	1202K046	010	83049
		R71-1004	010	83049
	Modelos con Suspensión de Aire Link Cabmate KWB689-A y montaje trasero de cabina Kenworth NP K235-1436 o K235-1488	1202-0012	010	83023
	Modelos con Suspensión de Aire Link Cabmate KWB689-B o KWB689-C y montaje trasero de cabina Kenworth NP K235-1436 o K235-1488	1201-1043	010	83025
		1202-1043	010	83025
	Modelos con Suspensión de Aire Link Cabmate KWMC642	1202-0054	010	83021

#### Aplicaciones Adicionales

	Dormitorio de 60" con Suspensión Link Cab	1202-0043	010	83032
--	---	-----------	-----	-------

**GUÍA DE APLICACIONES – CAMIONES, TRÁILERS Y AUTOBUSES**

Año	Modelo	# E.O.	Delantero		Trasero	
						
			Fleetline	GasSLX	Fleetline	GasSLX

**KENWORTH AMORTIGUADORES DE CABINA (Cont.)**

**Aplicaciones Adicionales (Cont.)**

86 -	Dormitorios Kenworth con Suspensión de Aire Link Cabmate KWS60-A y puertas con esquinas redondeadas	1201-1044	010		<b>83025</b>
	Modelos con Número de E.O.	1202K065	010		<b>83002</b>
		1202K164	010		<b>83031</b>
		1202K264	010		<b>83031</b>
		PP1058870	010		<b>83059</b>
		R71-6005	010		<b>83042</b>
		T71-1000	010		<b>83031</b>
		T71-1001	010		<b>83031</b>
		T71-1002	010		<b>83002</b>
	Modelos con Suspensión Link Cab	1202-0022	010		<b>83046</b>
		1202-0042	010		<b>83025</b>
- 82	Tractos Convencionales con cabinas Modelos A & Modelo Link Cabmate KWA900	1201-0012	010		<b>83023</b>
		1202-0012	010		<b>83023</b>

**KIMBLE MIXER CO**

	Mezcladoras con Descarga Trasera con Amortiguador de Eje con Autodirección	T91-00002-00		...	...	010	...	...
--	--	--------------	--	-----	-----	-----	-----	-----

**KING OF THE ROAD**

**MotorHomes Clase A**

04 - 06	MotorHomes Series Genesis con Chasis Freightliner XC Amortiguador Trasero con Número de E.O.	141700131809						
		16-16736-000			010	<b>85029</b>	...	
	Suspensión Delantera AS120	141700131810						
		16-16737-000	010	<b>83160</b>	...		...	
	Suspensión Delantera ZF - IFS con PBV de 23,000 lb o mayor	16-16874-000	010	<b>83160</b>	...		...	
		16-18103-000	010	<b>83160</b>	...		...	
	Suspensión Trasera ADL200 de 20K	481700000493	-1-	<b>85900</b>	...		...	
		16-16873-000	-1-	<b>85900</b>	...		...	
						010	<b>85029</b>	...

**KWK-LOC (JIFFLOX)**





	Dolly	CP-5222	010	<b>85315</b>	...		...	...
--	-------	---------	-----	--------------	-----	--	-----	-----

**LINK MANUFACTURING AMORTIGUADORES DE CABINA**

	Modelos con Suspensión Link Cab	1202-1046	010		<b>83049</b>
06 - 13	Modelos Peterbilt 335 Day Cab con Número Link	1202P055	010		<b>83061</b>
	Modelos con Suspensión Link Cab	1201-0012	010		<b>83023</b>
		1201-0154	010		<b>83051</b>
		1201-0254	010		<b>83051</b>
		1201-1043	010		<b>83025</b>
		1201-1044	010		<b>83025</b>
		1201-1046	010		<b>83049</b>
		1201-1049	010		<b>83025</b>
		1201-1212	010		<b>83013</b>
		1201-1213	01-		<b>83005</b>
		1201-9001	010		<b>83052</b>
		1201-9002	010		<b>83052</b>
		1201-9003	010		<b>83052</b>
		1201-9007	010		<b>83054</b>
		1201-9008	010		<b>83054</b>
		1201-9009	010		<b>83054</b>
		1201-9010	010		<b>83053</b>
		1201-9011	010		<b>83053</b>



**GUÍA DE APLICACIONES – CAMIONES, TRÁILERS Y AUTOBUSES**

Año	Modelo	# E.O.	Delantero		Trasero	
						
			Fleetline	GasSLX	Fleetline	GasSLX

**LINK MANUFACTURING AMORTIGUADORES DE CABINA (Cont.)**

Modelos con Suspensión Link Cab	1201-9013	01-	<b>83062</b>
	1201-9014	01-	<b>83062</b>
	1201-9018	01-	<b>83062</b>
	1201-9021	01-	<b>83062</b>
	1202-0012	010	<b>83023</b>
	1202-0022	010	<b>83046</b>
	1202-0032	010	<b>83016</b>
	1202-0042	010	<b>83025</b>
	1202-0043	010	<b>83032</b>
	1202-0044	010	<b>83025</b>
	1202-0052	010	<b>83021</b>
	1202-0054	010	<b>83021</b>
	1202-1042	010	<b>83025</b>
	1202-1043	010	<b>83025</b>
	1202-1044	010	<b>83025</b>
	1202-1064	010	<b>83024</b>
	1202-1065	010	<b>83002</b>
	1202-1164	010	<b>83031</b>
	1202-1212	010	<b>83013</b>
	1202-1213	01-	<b>83005</b>
	1202-1286	010	<b>83056</b>
	1202K065	010	<b>83002</b>
	1202K164	010	<b>83031</b>
	1202K264	010	<b>83031</b>
	1202K286	010	<b>83056</b>
	632120	010	<b>83046</b>
	632129	010	<b>83023</b>
	635705	010	<b>83016</b>
	654669	010	<b>83021</b>
	654799	010	<b>83025</b>
	654811	010	<b>83024</b>
	654833	010	<b>83021</b>
	654847	010	<b>83002</b>
	654849	010	<b>83031</b>
654867	010	<b>83025</b>	
LG40450	010	<b>83016</b>	
LG40470	010	<b>83016</b>	
R71-1004	010	<b>83049</b>	
R71-1005	010	<b>83024</b>	
T71-1000	010	<b>83031</b>	
T71-1001	010	<b>83031</b>	
T71-1002	010	<b>83002</b>	

**LINK MANUFACTURING LTD.**

(Vea También la Sección Especialidades)							
Modelos Sterling con Suspensión de Aire Trasera Link	1210-0528	...	...	010	<b>85904</b>	...	
Modelos con Número de E.O.	1210-0005	...	...	010	<b>85734</b>	...	
	671093	...	...	010	<b>85904</b>	...	

**LODAL, INC.**

Camión de Basura	9960257	010	<b>83122</b>	89406	...	...
------------------	---------	-----	--------------	-------	-----	-----

**M.A.N.**

Autobús Americana con Números de E.O.	25-1700-106-654	...	...	-1-	<b>85708</b>	...
	81-43701-6543	...	...	-1-	<b>85708</b>	...

## GUÍA DE APLICACIONES – CAMIONES, TRÁILERS Y AUTOBUSES

Año	Modelo	# E.O.	Delantero		Trasero	
			Fleetline	GasSLX	Fleetline	GasSLX

### M.A.N. (Cont.)

	Autobús Americana con Números de E.O.	81-43701-6572	- -	<b>85708</b>	...		...	...
		81-43701-6573	- -	<b>85722</b>	...		...	...
<b>05 - 08</b>	Autobús Modelos 18410	471700007680	- -	<b>85110</b>	...		...	...
		481700004476		...	...	- -	<b>85982</b>	...
		81-43701-6924	- -	<b>85110</b>	...		...	...
		81-43702-6089		...	...	- -	<b>85982</b>	...
	Eje Delantero - Autobús Articulado	81-43701-6538	- -	<b>85708</b>	...		...	...
	Eje Motriz - Autobús Articulado	81-43701-6537		...	...	- -	<b>85709</b>	...
	Eje Secundario - Autobús Articulado	81-43701-6539		...	...	- -	<b>85708</b>	...
	Modelos con Número de E.O.	134		...	...	- -	<b>85709</b>	...
		81-43701-6609		...	...	- -	<b>85709</b>	...
		9020M-1042		...	...	- -	<b>85709</b>	...

### MAC TRAILER MFG., INC.

Es necesaria la identificación de la suspensión para determinar qué sección del catálogo referir. Posibles opciones pueden ser Chalmers, Hendrickson, Neway, Ridewell, Reyco.					
---	--	--	--	--	--

### MACK





#### Series - CV

<b>02 - 07</b>	Modelos CV-713 con Eje Delantero de 18000 lb	14QK-366	o o	<b>85036</b>	<b>89405</b>		...	...
		25625151	o o	<b>85036</b>	<b>89405</b>		...	...
<b>02 - 07</b>	Modelos CV-713 con Suspensión Hendrickson Modelos HN-2	14QK-415M		...	...	o -	<b>83112</b>	...
		14QK-415M7		...	...	o -	<b>83112</b>	...
		25624241		...	...	o -	<b>83112</b>	...

#### Series - CX (Vision)

	Modelos con Suspensión de Aire Hendrickson (No. de Estampado 57241-4)	14QK-413M4		...	...	o -	<b>83110</b>	...
		25624341		...	...	o -	<b>83110</b>	...
	Modelos con Suspensión de Aire MACK HAS400	14QK-410M		...	...	o o	<b>83125</b>	...
		25625234		...	...	o o	<b>83125</b>	...
		47902-25		...	...	o o	<b>83125</b>	...
	Modelos con Suspensión Delantera de Muelles de 12000 lb	14QK-392BM3	o o	<b>85005</b>	<b>89430</b>		...	...
	Modelos con Suspensión MAC AL405	14QK-413M7		...	...	o -	<b>83111</b>	...
		25625223		...	...	o -	<b>83111</b>	...
		57241-006		...	...	o -	<b>83111</b>	...
	Modelos CX Vision con Muelles Parabólicas	14QK-431M		...	...	o o	<b>85061</b>	<b>89450</b>
	Modelos CX Vision con Suspensión de Aire Neway AD con amortiguadores de longitud extendida de 24.30"	14QK-414M2		...	...	o o	<b>85909</b>	...
		25624351		...	...	o o	<b>85909</b>	...
		25624837		...	...	o o	<b>85909</b>	...
	Modelos Vision CX con Suspensión de Aire Hendrickson	14QK-431M		...	...	o o	<b>85061</b>	<b>89450</b>
	Modelos Vision CX con Suspensión de Aire Hendrickson HA	14QK-410M2		...	...	o o	<b>83137</b>	...
		14QK-410M3		...	...	o o	<b>83125</b>	...
		25625254		...	...	o o	<b>83125</b>	...
	Modelos Vision CX con Suspensión de Aire Hendrickson HN-2	14QK-415M		...	...	o -	<b>83112</b>	...
		14QK-415M7		...	...	o -	<b>83112</b>	...
		25624241		...	...	o -	<b>83112</b>	...
	Modelos Vision CX con Suspensión de Aire MACK	14QK-3101M		...	...	o o	<b>85066</b>	<b>89448</b>
		471700000431		...	...	o o	<b>85066</b>	<b>89448</b>
		SDA471700000431		...	...	o o	<b>85066</b>	<b>89448</b>
	Modelos Vision CX con Suspensión Hendrickson ALV	14QK-413M5		...	...	o -	<b>83138</b>	...
		14QK-413M6		...	...	o -	<b>83111</b>	...
		25622221		...	...	o -	<b>83111</b>	...
		25625223		...	...	o -	<b>83111</b>	...
	Modelos con Número de E.O.	141700000373	o o	<b>85061</b>	<b>89450</b>		...	...
		20513881	o o	<b>85061</b>	<b>89450</b>		...	...

**GUÍA DE APLICACIONES – CAMIONES, TRÁILERS Y AUTOBUSES**

Año	Modelo	# E.O.	Delantero		Trasero	
						
			Fleetline	GasSLX	Fleetline	GasSLX

**MACK (Cont.)**

**Series CH (Cont.)**

Modelos CH con Suspensión de Aire Hendrickson HA	14QK-410M2		...	...	○ ○	<b>83137</b>	...
	14QK-410M3		...	...	○ ○	<b>83125</b>	...
	25625254		...	...	○ ○	<b>83125</b>	...
Modelos CH600 con Eje Estabilizador con Muelles Parabólicas	14QK-396	○ ○	<b>85005</b>	<b>89430</b>		...	...
Modelos CH600 con Muelles Taperleaf de 12000 lb	14QK-392AM	○ ○	<b>85005</b>	<b>89430</b>		...	...
	14QK-392BM	○ ○	<b>85005</b>	<b>89430</b>		...	...
	14QK-392BM3	○ ○	<b>85005</b>	<b>89430</b>		...	...
	14QK-396M		...	...	○ ○	<b>85005</b>	<b>89430</b>

**Series CH**

Modelos CH600 con Muelles Taperleaf de 12000 lb	25625743	○ ○	<b>85005</b>	<b>89430</b>		...	...
---	----------	-----	--------------	--------------	--	-----	-----

**Series CH**

Modelos CH600 con Suspensión AL	14QK-393M		...	...	○ ○	<b>85010</b>	...
Modelos CH600 con Suspensión de Aire HAS400 MACK	14QK-410M		...	...	○ ○	<b>83125</b>	...
	25625234		...	...	○ ○	<b>83125</b>	...

**Series CH**

Modelos CH600 con Suspensión de Aire HAS400 MACK	47902-25		...	...	○ ○	<b>83125</b>	...
--	----------	--	-----	-----	-----	--------------	-----

**Series CH**

Modelos CH600 con Suspensión de Aire Neway AD con amortiguadores de longitud extendida de 24.30"	14QK-414M2		...	...	○ ○	<b>85909</b>	...
	25624351		...	...	○ ○	<b>85909</b>	...
	25624837		...	...	○ ○	<b>85909</b>	...
Modelos CH600 con Suspensión Hendrickson ALV	14QK-413M5		...	...	○ -	<b>83138</b>	...
	14QK-413M6		...	...	○ -	<b>83111</b>	...
	25622221		...	...	○ -	<b>83111</b>	...
	25625223		...	...	○ -	<b>83111</b>	...
Modelos CH600 con Suspensión Hendrickson HN-2	14QK-415M		...	...	○ -	<b>83112</b>	...
	14QK-415M7		...	...	○ -	<b>83112</b>	...
	25624241		...	...	○ -	<b>83112</b>	...
Modelos CH600 con Suspensión ST34	14QK-2133M	○ ○	<b>85001</b>	<b>89410</b>		...	...
	25622466	○ ○	<b>85001</b>	<b>89410</b>		...	...
Modelos CH600 con Suspensión Trasera de Aire Hendrickson	14QK-393AM		...	...	○ ○	<b>83123</b>	<b>89405</b>

**Series CH**

Modelos CH600 con Suspensión Trasera de Aire Hendrickson	47902-9		...	...	○ ○	<b>83123</b>	<b>89405</b>
--	---------	--	-----	-----	-----	--------------	--------------

**Series CH**

Modelos CH600 con Suspensión Trasera Hendrickson AL-405	14QK-413M7		...	...	○ -	<b>83111</b>	...
	25625223		...	...	○ -	<b>83111</b>	...
	57241-006		...	...	○ -	<b>83111</b>	...
Modelos con Número de E.O.	14QK-2113P6		...	...	○ ○	<b>85007</b>	<b>89412</b>

**Series CH**

Intercambios Adicionales de E.O.	14QK-421M	○ ○	<b>85014</b>	...		...	...
----------------------------------	-----------	-----	--------------	-----	--	-----	-----





**Series CHN**

- 07 Modelos CHN-613 con Eje Delantero de 12000 lb	14QK-3107M	○ ○	<b>85061</b>	<b>89450</b>		...	...
	20973993	○ ○	<b>85061</b>	<b>89450</b>		...	...

**Series CL**

Modelos CL600, CL700 con Eje Estabilizador con Muelles	14QK-392AM	○ ○	<b>85005</b>	<b>89430</b>		...	...
	14QK-392BM	○ ○	<b>85005</b>	<b>89430</b>		...	...
	25625743	○ ○	<b>85005</b>	<b>89430</b>		...	...
Modelos CL600, CL700 con Suspensión de Aire HAS400 MACK	14QK-410M		...	...	○ ○	<b>83125</b>	...
	25625234		...	...	○ ○	<b>83125</b>	...
	47902-25		...	...	○ ○	<b>83125</b>	...
Modelos CL600, CL700 con Suspensión de Aire Hendrickson HA	14QK-410M2		...	...	○ ○	<b>83137</b>	...
	14QK-410M3		...	...	○ ○	<b>83125</b>	...
	25625254		...	...	○ ○	<b>83125</b>	...

**GUÍA DE APLICACIONES – CAMIONES, TRÁILERS Y AUTOBUSES**

Año	Modelo	# E.O.	Delantero		Trasero	
						
			Fleetline	GasSLX	Fleetline	GasSLX

**MACK (Cont.)**

**Series CL (Cont.)**

Modelos CL600, CL700 con Suspensión de Aire Neway AD con amortiguadores de longitud extendida de 24.30"	14QK-414M2	...	...	010	<b>85909</b>	...
	25624351	...	...	010	<b>85909</b>	...
	25624837	...	...	010	<b>85909</b>	...
Modelos CL600, CL700 con Suspensión de Muelles Multihojas	14QK-392AM2	010	<b>83123</b>	<b>89405</b>	...	...
	14QK-392BM2	010	<b>85321</b>	...	...	...
Modelos CL600, CL700 con Suspensión Hendrickson ALV	14QK-413M5	...	...	01-	<b>83138</b>	...
	14QK-413M6	...	...	01-	<b>83111</b>	...
	25622221	...	...	01-	<b>83111</b>	...
	25625223	...	...	01-	<b>83111</b>	...
Modelos CL600, CL700 con Suspensión Hendrickson HN-2	14QK-415M	...	...	01-	<b>83112</b>	...
	14QK-415M7	...	...	01-	<b>83112</b>	...
	25624241	...	...	01-	<b>83112</b>	...
Modelos CL600, CL700 con Suspensión ST34	14QK-2113	010	<b>85001</b>	<b>89410</b>	...	...
	14QK-2133M	010	<b>85001</b>	<b>89410</b>	...	...
	25621955	010	<b>85001</b>	<b>89410</b>	...	...

**Series CL**

Modelos CL600, CL700 con Suspensión ST34	25622466	010	<b>85001</b>	<b>89410</b>	...	...
--	----------	-----	--------------	--------------	-----	-----

**Series CL**

Modelos CL600, CL700 con Suspensión ST34	25632145	010	<b>85001</b>	<b>89410</b>	...	...
Modelos CL600, CL700 con Suspensión Trasera de Aire Hendrickson	14QK-393AM	...	...	010	<b>83123</b>	<b>89405</b>
	47902-9	...	...	010	<b>83123</b>	<b>89405</b>

**Series DM**

Modelos con Número de E.O.	14QK-2100P8	010	<b>83242</b>	...	...	...
	25622345	010	<b>83242</b>	...	...	...





**Series F**

Camión de Bomberos	.....	010	<b>85302 or 89420</b>			
Modelos F - Eastern	.....	010	<b>83221</b>	...	...	...
Modelos F (Exc. Eastern)	.....	010	<b>83207</b>	<b>89407</b>	010	<b>83215</b>
Modelos F con Suspensión Estándar	.....	...	...	...	010	<b>85305</b>
Modelos FL - Western	14QK-143	010	<b>83207</b>	<b>89407</b>	...	...
	14QK-2100D-P4	010	<b>83207</b>	<b>89407</b>	...	...

**Series GU - Granite Series**

<b>08 - 10</b>	Modelos GU-713 con Eje Delantero de 20000 lb	14QK-3108M	01-	<b>85080</b>	...	...	...
		14QK-427M	01-	<b>85080</b>	...	...	...
		20863239	01-	<b>85080</b>	...	...	...
		25626048	01-	<b>85080</b>	...	...	...
		471700000445	01-	<b>85080</b>	...	...	...
<b>08 - 15</b>	Modelos GU-713 con Muelles Delanteras de 14,600 lb a 18,000 lb	14QK-3116M	010	<b>83101</b>	...	...	...
		21010744	010	<b>83101</b>	...	...	...
	Modelos GU-713 con Número de E.O.	21687170	010	<b>85120</b>	...	...	...
<b>08 - 15</b>	Modelos GU-713 con Suspensión de Aire Trasera Hendrickson de 38000 lb	14QK-424M	...	...	010	<b>83147</b>	...
		20570098	...	...	010	<b>83147</b>	...
		60670-006	...	...	010	<b>83147</b>	...
<b>08 - 10</b>	Modelos GU-813 con Eje Delantero de 20000 lb	14QK-3108M	01-	<b>85080</b>	...	...	...
		14QK-427M	01-	<b>85080</b>	...	...	...
		20863239	01-	<b>85080</b>	...	...	...
		25626048	01-	<b>85080</b>	...	...	...
		471700000445	01-	<b>85080</b>	...	...	...
<b>08 - 15</b>	Modelos GU-813 con Muelles Delanteras de 14,600 lb a 18,000 lb	14QK-3116M	010	<b>83101</b>	...	...	...
		21010744	010	<b>83101</b>	...	...	...
	Modelos GU-813 con Número de E.O.	21687170	010	<b>85120</b>	...	...	...

## GUÍA DE APLICACIONES – CAMIONES, TRÁILERS Y AUTOBUSES

Año	Modelo	# E.O.	Delantero		Trasero	
						
			Fleetline	GasSLX	Fleetline	GasSLX

### MACK (Cont.)

#### Series GU - Granite Series (Cont.)

08 - 15	Modelos GU-813 con Suspensión de Aire Trasera Hendrickson de 38000 lb	14QK-424M 20570098 60670-006		...	...	OIO	83147	...
				...	...	OIO	83147	...
				...	...	OIO	83147	...

#### Series MH

	Modelos MH - Muelles de 4" de Ancho	14QK-373	OIO	83215	...		...	...
		14QK-378M	OIO	83215	...		...	...
		25623321	OIO	83215	...		...	...
	Modelos MH con Número de E.O.	14QK-2113P5	OIO	85001	89410		...	...
		14QK-2133M	OIO	85001	89410		...	...
		14QK-2133M2	OIO	85001	89410		...	...
		14QK-377M	OIO	83215	...		...	...
		14QK-392AM	OIO	85005 or 89430			...	...
		25622466	OIO	85001	89410		...	...
	Modelos MH con Suspensión de Aire Neway ARD-234	14QK-375M		...	...	OIO	83123	89405
	Modelos MH con Suspensión de Muelles Traseras Taperleaf	14QK-2113P4		...	...	OIO	85007	89412
	Modelos MH con Suspensión Trasera de Ballestas Parabólicas (SS34 & 38)	14QK-2107P1		...	...	OIO	83215	...
		14QK-2107P2		...	...	OIO	83215	...
		25625091		...	...	OIO	83215	...

#### Series MidLiner - CS, MS

	Modelos CS Mid-Liner con Número de E.O.	4103-5000447861	-IO	83105	...		...	...
		4103-5000546892	-IO	83105	...		...	...
		V10234121	-IO	83105	...		...	...
		V10242320	-IO	83105	...		...	...
	Modelos Mid-Liner MS200, MS300	V10234121	-IO	83105	...		...	...

#### Series MR

	Modelos con Número de E.O.	14QK-3115M	OIO	85972	...		...	...
		21002497	OIO	85972	...		...	...

#### Series Pinnacle - CHU

08 - 14	Modelos CHU-613 con Eje Delantero de 12000 lb o 14600 lb	14QK-434M	OIO	85014	...		...	...
		20625775	OIO	85014	...		...	...
		SDA471700002861	OIO	85014	...		...	...
08 - 15	Modelos CHU-613 con Eje Delantero de 12000 lb o 14600 lb	20998401	OIO	85014	...		...	...
- 15	Modelos CHU-613 con Número de E.O.	25625091		...	...	OIO	83215	...
08 - 14	Modelos CHU-613 con Suspensión Trasera de Aire Hendrickson de 38000 lb	14QK-424M		...	...	OIO	83147	...
		20570098		...	...	OIO	83147	...
		60670-006		...	...	OIO	83147	...





#### Series Pinnacle CXU

08 - 10	Modelos CXU-613 con Eje Delantero de 12000 lb	141700000380	OIO	85061	89450		...	...
		14QK-3114M	OIO	85061	89450		...	...
		20973993	OIO	85061	89450		...	...
		SDA141700000380	OIO	85061	89450		...	...
14 - 15	Modelos CXU-613 con Eje Delantero de 12000 lb	21436096	OIO	85098	...		...	...
2014	Modelos CXU-613 con Eje Delantero de 12000 lb	141700005839	OIO	85098	...		...	...
08 - 10	Modelos CXU-613 con Suspensión de Aire Trasera de 40000 lb	14QK-2136M		...	...	OIO	85061	89450
		20897198		...	...	OIO	85061	89450
		471700002626		...	...	OIO	85061	89450
2014	Modelos CXU-613 con Suspensión de Aire Trasera de 40000 lb	21462382		...	...	OIO	85088	...
		471700006039		...	...	OIO	85088	...

#### Series R

	Modelos R, RU, RD600 - Ancho de Muelles de 3 1/2"	14QK-366P1	OIO	85036	89405		...	...
	Modelos R, U	....	OIO	83221	...	OIO	83215	...
	Modelos R, U, RD 600	14QK-2115	OIO	85305	...		...	...

**GUÍA DE APLICACIONES – CAMIONES, TRÁILERS Y AUTOBUSES**

Año	Modelo	# E.O.	Delantero		Trasero	
			 Fleetline	 GasSLX	 Fleetline	 GasSLX

**MACK (Cont.)**

**Series R (Cont.)**

Modelos R, U, RD 600	14QK-29302 25632147	OIO	83207	89407		...	...
			85305	...		...	...
Modelos R, U, RD 600 / Modelos MR600 con Muelles Taperleaf Delanteras	14QK-366 14QK-366P1 25625151	OIO	85036	89405		...	...
			85036	89405		...	...
			85036	89405		...	...
Modelos RB 600 (Eje Motriz)	14QK-2107 14QK-393M		...	...	OIO	83215	...
			...	...	OIO	85010	...
Modelos RD con Suspensión ST34	14QK-2133M 25622466	OIO	85001	89410		...	...
		OIO	85001	89410		...	...
Modelos RD800 con Amortiguadores & Suspensión Taperleaf (SWT & SWTL 561)(ST-34)	14QK-2110	OIO	85305	...		...	...

**Series RW**

Modelos RW - Ancho de Muelles de 4"	14QK-373 14QK-378M 25623321	OIO	83215	...		...	...
		OIO	83215	...		...	...
		OIO	83215	...		...	...
Modelos RW con Número de E.O.	14QK-2113P5 14QK-2133M 14QK-2133M2 14QK-377M 14QK-392AM 25622466	OIO	85001	89410		...	...
		OIO	85001	89410		...	...
		OIO	85001	89410		...	...
		OIO	83215	...		...	...
		OIO	85005 or 89430			...	...
Modelos RW con Suspensión de Aire Neway ARD-234	14QK-375M		...	...	OIO	83123	89405
Modelos RW con Suspensión Trasera de Muelles Parabólicas (SS34 & 38)	14QK-2107P1 14QK-2107P2 25625091		...	...	OIO	83215	...
			...	...	OIO	83215	...
			...	...	OIO	83215	...
Modelos RW con Suspensión Trasera Taperleaf	14QK-2113P4		...	...	OIO	85007	89412

**TD - Series Titan**

08 - 10	Modelos TD-713 con Eje Delantero de 20000 lb	14QK-493M 21155033	OIO	83101	...		...	...
			OIO	83101	...		...	...
08 - 10	Modelos TD-713 con Suspensión de Aire Trasera Hendrickson de 38000 lb	14QK-424M 60670-006		...	...	OIO	83147	...
				...	...	OIO	83147	...
08 - 14	Modelos TD-713 con Suspensión de Aire Trasera Hendrickson de 38000 lb	20570098		...	...	OIO	83147	...

**Aplicaciones Adicionales**

	Chasis para Camión de Bomberos CF	14QK-2102		...	...	OIO	85304	...
	CM 422 Tracto	14QK-390 V10242320	-IO	83105	...		...	...
			-IO	83105	...		...	...
	Eje Bogie Modelo 75	....		...	...	OIO	83215	...
	Modelos B	14QK-142		...	...	OIO	85305	...
	Modelos con Muelles Taperleaf de 12000 lb	14QK-392AM3	OIO	85005	89430		...	...
	Modelos con Suspensión de Aire Hendrickson HAS-40LH (Número de E.O. 57241-4)	14QK-413M4		...	...	OIO	83110	...
06 - 09	Modelos con Suspensión de Aire Hendrickson Primaax de 40,000 lb, Pimaax EX y FireMaax EX	60657-007		...	...	OIO	85072	...
	Modelos con Suspensión de Ballestas Parabólicas Invertidas	14QK-142P1	OIO	83215	...		...	...
	Modelos con Suspensión Delantera de Aire Hendrickson AirTek	14QK-422M 20485633 471700131921 64838-002	OIO	85933	89454		...	...
			OIO	85933	89454		...	...
			OIO	85933	89454		...	...
			OIO	85933	89454		...	...
	Modelos con Suspensión MAC AL405	14QK-413M		...	...	OIO	83111	...
	Modelos con Suspensión Meritor AirLink	14QK-3100 446-51-211		...	...	OIO	85739	...
				...	...	OIO	85739	...
	Modelos con Suspensión Trasera Neway (con Estampado de E.O. 90045099)	14QK-414M		...	...	OIO	85906	89407

## GUÍA DE APLICACIONES – CAMIONES, TRÁILERS Y AUTOBUSES

Año	Modelo	# E.O.	Delantero		Trasero	
			Fleetline	GasSLX	Fleetline	GasSLX

### MACK (Cont.)





#### Aplicaciones Adicionales (Cont.)

	Modelos con Suspensión Trasera Neway (con Estampado de E.O. 90045099)	25633154		...	...	010	85906	89407
	Modelos DM	.....	010	83209	89414	010	83215	...
	Modelos MB	.....	010	83221	...	010	83215	...
		14QK-2100P4	010	83207	89407		...	...
<b>75 - 79</b>	Modelos W - Western	.....	010	83207	89407	010	83215	...

#### Intercambios Adicionales de E.O.

	Modelos con Número de E.O.	14QK-1200P4	010	83207	89407		...	...		
		14QK-140	010	85304	...		...	...		
		14QK-142AP1	010	83215	...		...	...		
		14QK-145	010	85307	...		...	...		
		14QK-2100P2	010	83209	89414		...	...		
		14QK-2100P3	010	83207	89407		...	...		
		14QK-2100P5	010	83221	...		...	...		
		14QK-2100P6	010	85036	89405		...	...		
		14QK-2100P7	010	83221	...		...	...		
		14QK-2105	010	83209	89414		...	...		
		14QK-2107P3	010	83215	...		...	...		
		14QK-2108	010	83203	89436		...	...		
		14QK-2108P1	010	83203	89436		...	...		
		14QK-2113P3	010	85001	89410		...	...		
		14QK-2113P6	010	85007	89412		...	...		
		14QK-288-P1	010	85007	89412		...	...		
		14QK-29001P2	010	85303	89422		...	...		
		14QK-29301P1	010	83207	89407		...	...		
		14QK-29301P2	010	83207	89407		...	...		
		14QK-366P2	010	85036	89405		...	...		
		14QK-366P3	010	85036	89405		...	...		
		14QK-372M3	010	83122	89406		...	...		
		14QK-378	010	83215	...		...	...		
		14QK-423M		...	...	010	85978	...		
		25621571	010	83215	...		...	...		
		471700002861	010	85014	...		...	...		
		57241-004		...	...	01-	83110	...		
		5966-90044025	010	83209	89414		...	...		
		651103	010	85036	89405		...	...		
		8083872		...	...	010	85978	...		
			Intercambios Adicionales de E.O.	14QK-140P1	010	83225				
				14QK-20001P2	010	85308 or 89422				
14QK-2100	010			83221						
14QK-2100P1	010			83221						
14QK-2110P1	010			85305						
14QK-282P1	010			83216						
14QK-282P3	010			83216						
14QK-288P2	010			83217						
14QK-29302P1	010			83207 or 89407						
14QK-3108	01-			85080						
14QK-366P4	010			83209 or 89414						
14QK-372M	010			83221						
14QK-372M2	010			83209 or 89414						
14QK-392M	010			85005 or 89430						
14QK-428	01-			85080						
14QK-428M	01-			85080						
25624365	010			83217						
25625187	010	83209 or 89414								

**GUÍA DE APLICACIONES – CAMIONES, TRÁILERS Y AUTOBUSES**

Año	Modelo	# E.O.	Delantero		Trasero	
						
			Fleetline	GasSLX	Fleetline	GasSLX

**MACK (Cont.)**

**Intercambios Adicionales de E.O. (Cont.)**

Intercambios Adicionales de E.O.	25626149	01-	85080
	47170000451	01-	85080
	4940654	010	83216
	5533699	010	85302 or 89420
	5554184	010	85302 or 89420
	650102	010	85001 or 89410
	650107	-10	85316 or 89426
	650107MT	-10	85316 or 89426
	650400MT	-10	85033 or 89427
	650402	-10	85311 or 89424
	650402MT	-10	85311 or 89424
	650404	-1-	85310 or 89423
	650404MT	-1-	85310 or 89423
	650405	010	85023 or 89415
	650405MT	010	85023 or 89415
	650406	010	85024 or 89416
	650408	-10	85319 or 89428
	650408MT	-10	85319 or 89428
	651012	010	83221
	651151	010	83209 or 89414
70042	010	85302 or 89420	

**MACK AMORTIGUADORES DE CABINA**

**Series - CT, CTX**

Modelos con Número de E.O.	14QK-303M	01-	83050
	14QK-3103M	01-	83050
	20874147	01-	83050

**Series - CX (Vision)**

Modelos con Cabina Dormitorio y Número de E.O.	14QK-399M	01-	83045
	14QK-399M2	01-	83045
	14QK-399M3	01-	83045
	25625635	01-	83045
	25625636	01-	83045
	25625637	01-	83045

**Series CH**

Modelos con Número de E.O.	14QK-411	010	83007
	14QK-411AM	010	83007
	14QK-411M	010	83007
	25631922	010	83007

**Series CL**

Modelos con Número de E.O.	14QK-391AM	01-	83041
	14QK-391AM2	01-	83041

**Series GU - Granite Series**









Modelos GU 713 y GU 813 con Número de E.O.	21345869	010	83066	
	21490486	010	83066	
08 -	Modelos GU 713 y GU 813 con Número de E.O.	14QK-432M	01-	83050
		20873442	01-	83050

**Series Pinnacle - CHU**

Modelos CHU-613 con Número de E.O.	21345869	010	83066	
	21490486	010	83066	
08 - 11	Modelos CHU-613 con Número de E.O.	14QK-303M	01-	83050
		14QK-3103M	01-	83050
		20874147	01-	83050



## GUÍA DE APLICACIONES – CAMIONES, TRÁILERS Y AUTOBUSES

Año	Modelo	# E.O.	Delantero		Trasero	
						
						
			Fleetline	GasSLX	Fleetline	GasSLX

### MACK AMORTIGUADORES DE CABINA (Cont.)

#### Series Pinnacle CXU (Cont.)

- 14	Modelos CXU-613 con Cabinas con Dormitorio de Número de E.O.	25625635	01-	83045
	Modelos CXU-613 con Número de E.O.	21345869	010	83066
		21490486	010	83066
08 - 11	Modelos CXU-613 con Número de E.O.	14QK-303M	01-	83050
		14QK-3103M	01-	83050
		20874147	01-	83050

#### Series R

	Modelos R, RD	14QK-382	01-	83018
		14QK-382-P2	01-	83018
	Modelos R, RD400 & 600 con Suspensión de Aire para Cabina	14QK-2111-P4	01-	83019
	Modelos RW	14QK-29303-P2	-1-	83014
	Tractos R 600 con Modelo Link Cabmate MCR600	1201-0012	010	83023
		1202-0012	010	83023
	Tractos RS & Superliner con Modelo Link Cabmate CRS600	1201-0012	010	83023
		1202-0012	010	83023

#### TD - Series Titan

	Modelos TD - Titan con Número de E.O.	14QK-440M	01-	83058
		21154397	01-	83058





#### Aplicaciones Adicionales

	Modelos con Número de E.O.	14QK-2111	01-	83019
		14QK-2111-P2	01-	83019
		14QK-391BM2	01-	83041
		14QK-391M	01-	83041
		14QK-391M2	01-	83041
		14QK-439M	01-	83050
		21154393	01-	83050
		25622612	01-	83041
		25622613	01-	83041
	Modelos con Suspensión Link Cab	1202-0012	010	83023
		1202-0022	010	83046
		1202-0032	010	83016
02 - 07	Modelos CV-713 con Número de E.O.	14QK-391BM	01-	83041
	Modelos MH con Cabina de Aire	14QK-374	-10	83003
		14QK-376	-10	83003

### MAECO

	Autobús con Número de E.O.	1668722	010	85030 or 89440			
	Camiones FedEx con Número de E.O.	16950	010	83118	...	...	...
	Camiones UPS con Número de E.O.	16949		...	...	01-	83120
	Intercambios Adicionales de E.O.	1085	010	83214			
		12608	010	83125			
		12788	010	83216			
		12866	010	83207 or 89407			
		16385	010	83215			
		16720	010	83107			
		16767	010	85013			
		16768	010	83217			
		16769	010	83221			
		16770	010	83209			
		16771	010	83126 or 89430			
		16772	010	83122 or 89406			
		16773	010	85005			
		16774	010	83215			
		16775	010	83207 or 89407			

**GUÍA DE APLICACIONES – CAMIONES, TRÁILERS Y AUTOBUSES**

Año	Modelo	# E.O.	Delantero		Trasero	
						
			Fleetline	GasSLX	Fleetline	GasSLX

**MAECO (Cont.)**









Intercambios Adicionales de E.O.	16776	010	83202
	16777	010	85006
	16778	010	83203
	16779	010	83126 or 89440
	16780	010	83123 or 89405
	16781	010	85006
	16787	010	85030 or 89440
	6025	010	83122 or 89406
	6026	010	83204
	70018	010	85303 or 89422
	70021	010	85303 or 89422
	70029	010	85308 or 89422
	70034	010	85302 or 89420
	70039	010	85303 or 89422
	70041	010	85305
	70042	010	85302 or 89420
	70088	010	85307
	70123	010	85716
	70127	010	85006 or 89401
	70128	010	85006 or 89401
	70162	010	85716
	70163	010	85302 or 89420
	70164	010	85716
	70300	010	85320 or 89429
	70312	010	85001 or 89410
	70315	010	85063
	70317	010	89432
	70331	010	85314 or 89425
	70332	010	83314
	70334	10	85316 or 89426
	70397	010	85006
	70402	010	85305
	70642	010	85300
	70644	010	85334
	70646	010	85313
	70647	11	85701
	70648	010	89414
	70650	010	89440
	70651	010	85013 or 89414
	70652	010	85030 or 89440
	70663	010	85013 or 89414
	70691	010	85007
	70720	010	85934
	70721	010	83125
	74039	010	85303 or 89422
OE10881	10	85711	
OE10882	01	85740	
OE10883	010	85339	
OE12425	010	83214	
SC-2920	010	83176	

**MANDALAY COACH**

**MotorHomes Clase A**

04 - 06	MotorHomes Series Mandalay con Chasis Freightliner XC Amortiguador Trasero con Número de E.O.	141700131809				
			...	...	010	85029

## GUÍA DE APLICACIONES – CAMIONES, TRÁILERS Y AUTOBUSES

Año	Modelo	# E.O.	Delantero		Trasero	
						
						
			Fleetline	GasSLX	Fleetline	GasSLX

### MANDALAY COACH (Cont.)

#### MotorHomes Clase A (Cont.)

<b>04 - 06</b>	Amortiguador Trasero con Número de E.O.	16-16736-000		...	...	OIO	<b>85029</b>	...
	Suspensión Delantera AS120	141700131810	OIO	<b>83160</b>	...		...	...
		16-16737-000	OIO	<b>83160</b>	...		...	...
		16-16874-000	OIO	<b>83160</b>	...		...	...
	Suspensión Delantera ZF - IFS con PBV de 23,000 lb o mayor	16-18103-000	-I-	<b>85900</b>	...		...	...
		481700000493	-I-	<b>85900</b>	...		...	...
	Suspensión Trasera ADL200 de 20K	16-16873-000		...	...	OIO	<b>85029</b>	...
<b>06</b>	MotorHomes Series Presidio & Valencia con Chasis Freightliner XC							
	Amortiguador Trasero con Número de E.O.	141700131809		...	...	OIO	<b>85029</b>	...
		16-16736-000		...	...	OIO	<b>85029</b>	...
	Suspensión Delantera AS120	141700131810	OIO	<b>83160</b>	...		...	...
		16-16737-000	OIO	<b>83160</b>	...		...	...
		16-16874-000	OIO	<b>83160</b>	...		...	...
	Suspensión Delantera ZF - IFS con PBV de 23,000 lb o mayor	16-18103-000	-I-	<b>85900</b>	...		...	...
		481700000493	-I-	<b>85900</b>	...		...	...

### MARMON

	Modelos con Número de E.O.	1-7001	OIO	<b>83216</b>	...		...	...
		37-1-1	OIO	<b>83122</b>	89406		...	...
		51-139-28		...	...	OIO	<b>85003</b>	89411
		51-163-7		...	...	OIO	<b>83123</b>	89405
		576451	OIO	<b>83122</b>	89406		...	...
		665147	OIO	<b>83216</b>	...		...	...

### MARMON AMORTIGUADORES DE CABINA

	Modelos con Suspensión Link Cab	1202-0022	OIO	<b>83046</b>	
<b>81 -</b>	Tractos Convencionales con Modelo Link Cabmate MARC57-B	1202-0054	OIO	<b>83021</b>	





### MATSON SCHOOL BUS

	Modelos con Número de E.O.	5392387	OIO	<b>85303</b>	89422		...	...
--	----------------------------	---------	-----	--------------	-------	--	-----	-----

### MC NEILUS TRUCK & MAN.

	Modelos con Número de E.O.	217330	OIO	<b>85303</b>				
	Número de Parte Mc Neilus	1139039 MTM	OIO	<b>85334</b>	...		...	...
		1139046 MTM		...	...	OIO	<b>83112</b>	...
		1139059 MTM		...	...	OIO	<b>83207</b>	89407
		1139069 MTM		...	...	OIO	<b>83209</b>	89414
		12405FX1 MTM	OIO	<b>85303 or 89422</b>				
		1323106 MTM		...	...	OIO	<b>85305</b>	...
		1333575 MTM		...	...	OIO	<b>85072</b>	...
		1340975 MTM		...	...	OIO	<b>83142</b>	...
		1340976 MTM	OIO	<b>85919</b>	...		...	...
		1340979 MTM		...	...	OIO	<b>83143</b>	...
		1360386 MTM		...	...	OIO	<b>85323</b>	89436
		1367383 MTM		...	...	OIO	<b>83147</b>	...
		1396513 MTM	OIO	<b>85959</b>	...		...	...
		1398980 MTM		...	...	OIO	<b>83127</b>	...
		1404068 MTM		...	...	OIO	<b>85980</b>	...
		1404068 MTM		...	...	OIO	<b>85087</b>	...
		1410046 MTM	OIO	<b>85919</b>	...		...	...
		1411765 MTM		...	...	OIO	<b>83148</b>	...
		1412744 MTM		...	...	OIO	<b>85966</b>	...
		1429317 MTM	OIO	<b>85919</b>				

**GUÍA DE APLICACIONES – CAMIONES, TRÁILERS Y AUTOBUSES**

Año	Modelo	# E.O.	Delantero		Trasero	
						
			Fleetline	GasSLX	Fleetline	GasSLX

**MC NEILUS TRUCK & MAN. (Cont.)**

Año	Modelo	# E.O.	Delantero	Trasero
	Número de Parte Mc Neilus	1431085 MTM	...	...
		1432386 MTM	...	...
		1433009 MTM	...	...
		1468783 MTM	...	...
		1485576 MTM	...	...
		1491909 MTM	...	...
		1KK552 MTM	...	...
		2218640 MTM	...	...
		3215395 MTM	...	...
		3HR582 MTM	...	...
		3HR582 MTM	...	...
		3HR916 MTM	...	...
		4HA569 MTM	...	...
		4KP398 MTM	...	...
		5HA994 MTM	...	...
		5HB645 MTM	...	...
		5HB645 MTM	...	...
		5KK247 MTM	...	...
		64442AX MTM	...	...
		6HA961 MTM	...	...
		6HB390 MTM	...	...
		6HB390 MTM	...	...
		6HD720 MTM	...	...
		6HS773 MTM	...	...
		6KP857 MTM	...	...
		7HS237 MTM	...	...
		7HS237 MTM	...	...
		7HS534 MTM	...	...
		8KK524 MTM	...	...
		9HB362 MTM	...	...
		9HB362 MTM	...	...
		9KK464 MTM	...	...

**MERCEDES BENZ**

02 - 04	Andare Autobús (Suspensión Neway)		010	85005	89430		...	...
90 - 02	Boxer HPN Midibus Urbano (Magno 930 Urbano)		010	85006	...	01-	85103	...
01	Busscar 320		010	85005	89430		...	...
93 - 01	Carrocería Irizar	3643267200	-1-	83173				
		L-12657	-1-	83173				
88 - 92	Famsa Suburbano		010	85006	...	01-	85103	...
	L1013, L1113	344-323-75	010	83100	...		...	...
	L1116, L-1117 - Exc. Base de Rueda de 5900 mm	344-323-75	010	83100	...		...	...
03 - 05	MBO Boxer Serie 1419, 1423, 1438, 1444 (Magno 930)	16-16782-000		...	...	01-	85096	...
		16-16868-000	010	85095	...		...	...
	Mercedes Benz Chasis de 9 / 14 Ton		010	85006	...	01-	85103	...
	Modelos Marcopolo Paradiso 1200	471700004270		...	...	-1-	85117	...
		481700004271	01-	85993	...		...	...
		A3263260000		...	...	-1-	85117	...
		A3563260700		...	...	-1-	85117	...
		A6293220000	01-	85993	...		...	...
		A6293230100	01-	85993	...		...	...
03 - 05	Modelos Torino OMC	16-16781-000	010	85108	...		...	...
89 - 94	MP 100 - 2 ejes	3643267200	-1-	83173	...		...	...
		L-12657	-1-	83173	...		...	...
	Multego OC-500 Foráneo	364 323 72 00	-1-	85093				

## GUÍA DE APLICACIONES – CAMIONES, TRÁILERS Y AUTOBUSES

Año	Modelo	# E.O.	Delantero		Trasero	
			Fleetline	GasSLX	Fleetline	GasSLX

### MERCEDES BENZ (Cont.)

	Multego OC-500 Foráneo	CL12657-5521	- -	<b>85093</b>				
	Multego OC-500 Urbano	364 323 74 00	- -	<b>85324</b>				
	O-370 Mercedes Benz con Número de E.O.	45280-6918		...	...	0 -	<b>85973</b>	...
<b>10 - 13</b>	OF 1218 LA904	3843230500	- 0	<b>85981</b>	...		...	...
		A3843230300	- 0	<b>85981</b>	...		...	...
		ZGS002-001	- 0	<b>85981</b>	...		...	...
<b>10 - 13</b>	OF MBCO 1319/44	3843230500	- 0	<b>85981</b>	...		...	...
		A3843230300	- 0	<b>85981</b>	...		...	...
		A3843260200		...	...	0 0	<b>83172</b>	...
		ZGS002-001	- 0	<b>85981</b>	...		...	...
		ZGS006-001		...	...	0 0	<b>83172</b>	...
<b>03 - 05</b>	OMC Torino	16-16782-000		...	...	0 -	<b>85096</b>	...
<b>93 - 01</b>	Serie O371 Autobús 2 y 3 ejes	3643267200	- -	<b>83173</b>				
		L-12657	- -	<b>83173</b>				
<b>2011</b>	Torino OH906	3683230100	- 0	<b>85981</b>	...		...	...
		ZGS004-001	- 0	<b>85981</b>	...		...	...

### MERITOR

	FS230T	21227751		...	...	0 0	<b>87015</b>	...
		671020		...	...	0 0	<b>87015</b>	...
	Suspensión Air Link AL460	700115		...	...	0 0	<b>85712</b>	...
	Suspensión Air Link AL520	700115		...	...	0 0	<b>85712</b>	...
	Suspensión de Aire para Tráiler Modelos MTA 25T / MTA 30T	671506		...	...	0 0	<b>86200</b>	...
		7805-F-1020		...	...	0 0	<b>86200</b>	...
		A-7805F-1020		...	...	0 0	<b>86200</b>	...
	Suspensión de Aire para Tráiler Modelos RFS 23T / 25T / 30T	21227751		...	...	0 0	<b>87015</b>	...
		A-7805L-1026		...	...	0 0	<b>87015</b>	...
	Suspensión de Tráiler RHP11, RHP55 y RideSentry	202447		...	...	0 0	<b>85919</b>	...
		A-3280-M-9711		...	...	0 0	<b>85919</b>	...
<b>01 -</b>	Suspensión de Tráiler RHP11, RHP55 y RideSentry	A-7805L-1000		...	...	0 0	<b>85919</b>	...
	Suspensión FlexAir 9NB con Número de E.O.	21224745		...	...	0 0	<b>86203</b>	...
		21224778		...	...	0 0	<b>86202</b>	...
		671502		...	...	0 0	<b>86202</b>	...
		671503		...	...	0 0	<b>86203</b>	...
	Suspensión para Tráiler FS230 (Light Duty)	A-7805P-1030		...	...	0 0	<b>85737</b>	...
	Suspensión para Tráiler FS230 (Standard Duty)	671507		...	...	0 0	<b>87015</b>	...
		A-7805L-1026		...	...	0 0	<b>87015</b>	...
	Suspensión RC S 9L	21228392		...	...	0 0	<b>86201</b>	...
		671500		...	...	0 0	<b>86201</b>	...
	Suspensiones Air Link con Número de E.O.	14QK-3100		...	...	0 0	<b>85739</b>	...
		446-51-211		...	...	0 0	<b>85739</b>	...
	Modelos con Número de E.O.	671507		...	...	0 0	<b>87015</b>	...
		671907		...	...	0 0	<b>85919</b>	...
		680705		...	...	0 0	<b>85737</b>	...

### MITSUBISHI-FUSO

#### Series FE

<b>07/86 -</b>	FE434, FE439, FE444, FE450	MB025382		.....				
				...	...	0 0	<b>G63299</b>	...
<b>96 - 97</b>	FE639, FE639SP, FE639HDT	MC114595		...	...	0 0	<b>G63405</b>	...

#### Series FF

<b>86 - 87</b>	FF415	MC813511	- -	<b>G63398</b>	...		...	...
----------------	-------	----------	-----	---------------	-----	--	-----	-----

#### Series FH

<b>10/87- 96</b>	Suspensión FH100 (Todas)	MC809390		...	...	- -	<b>83103</b>	...
		MC826268	- 0	<b>G63610</b>	...		...	...

## GUÍA DE APLICACIONES – CAMIONES, TRÁILERS Y AUTOBUSES

Año	Modelo	# E.O.	Delantero				Trasero	
							Fleetline	GasSLX

### MITSUBISHI-FUSO (Cont.)

#### Series FK (Cont.)

11/85-11/86	FK414	MC813511	-I-	<b>G63398</b>	...		...	...
06/88-02/91	FK455	MC814614	-IO	<b>85009</b>	...		...	...
03/91-06/93	FK457	MC814614	-IO	<b>85009</b>	...		...	...

#### Series FM

06/88-02/91	FM555	MC814614	-IO	<b>85009</b>	...		...	...
11/85-05/88	FM555	MC813135	-I-	<b>83456</b>	89447		...	...
05/89-06/93	FM557	MC814614	-IO	<b>85009</b>	...		...	...

### MOHAWK

Intercambios Adicionales de E.O.	01-0100-905	OIO	<b>85303 or 89422</b>				
	020273544	OIO	<b>83203 or 89436</b>				
	050134508	OIO	<b>85718</b>				
	10134504	OIO	<b>85715</b>				
	10134506	OIO	<b>85714</b>				
	10234503	OIO	<b>85714</b>				
	10234504	OIO	<b>85717</b>				
	1235233	OIO	<b>85736</b>				
	22012079	-I-	<b>85701</b>				
	22012082	OIO	<b>85702</b>				
	22012114	OIO	<b>85700</b>				
	4968853	OIO	<b>83216</b>				
	6-367-7	OIO	<b>85305</b>				
	680323	OIO	<b>85700</b>				
	680332	-I-	<b>85701</b>				
	680485	OI-	<b>85733</b>				
	695195	-I-	<b>85707</b>				
	695196	-I-	<b>85707</b>				
97-2201-00007	-IO	<b>85703</b>					
97-2201-00011	OIO	<b>85704</b>					
97-9999-02320	OIO	<b>85704</b>					
MM-6886	OIO	<b>83207 or 89407</b>					
MM-6957	OIO	<b>83225</b>					
MM-74029	OIO	<b>85308 or 89422</b>					

### MONACO

95 - 99	MotorHomes con Chasis Freightliner XC	.....	OIO	<b>83160</b>	...	OIO	<b>85029</b>	...
90 - 97	Series Monarch & LaPalma con Chasis Motorhome F53 (7.5 L, Gas V8)	.....	OIO	<b>83209</b>	...	OIO	<b>85097</b>	...
99 - 03	Series Monarch & LaPalma con Chasis Motorhome F53 con PBV 16,000 lb a 22,000 lb	.....	OIO	<b>83209</b>	...	OIO	<b>83122</b>	...

### MOR-RYDE SUSPENSION

Camper	U0109-014		...	...	-I-	<b>83400</b>	...
	U0109-018		...	...	OIO	<b>G63866</b>	...
Suspensión para Autobús	.....		...	...	-I-	<b>83103</b>	...
	U0109-006		...	...	OIO	<b>G63866</b>	...
Trasero de Tráiler	U0109-007		...	...	OIO	<b>G63183</b>	...

### MOTOR COACH INDUSTRIES

#### Aplicaciones Adicionales

Autobús RTS con "V" Drive Trasero	G1101590GS		...	...	OIO	<b>85713</b>	...
-----------------------------------	------------	--	-----	-----	-----	--------------	-----

## GUÍA DE APLICACIONES – CAMIONES, TRÁILERS Y AUTOBUSES

Año	Modelo	# E.O.	Delantero		Trasero	
			 Fleetline	 GasSLX	 Fleetline	 GasSLX

### MOTOR COACH INDUSTRIES (Cont.)



#### Aplicaciones Adicionales (Cont.)

Autobús RTS con Eje Delantero Rígido	22024673	-10	<b>85710</b>	...		...	...
Autobús RTS con Frente Normal	695117	-1-	<b>85701</b>	...		...	...
	74410	-1-	<b>85701</b>	...		...	...
Autobús RTS con Trasero Regular	G1011822		...	...	010	<b>85702</b>	...
Eje Motriz	12J-5-2		...	...	01-	<b>85312</b>	...
	12J-5-4		...	...	01-	<b>85312</b>	...
	12L-5-71		...	...	-1-	<b>85708</b>	...
	T14-1081		...	...	01-	<b>85729</b>	...
Eje Tarjeta	12-05-6068		...	...	-1-	<b>85727</b>	...
	12J-5-11		...	...	010	<b>85313</b>	...
	12J-5-3		...	...	010	<b>85313</b>	...
	T14-1082		...	...	-1-	<b>85727</b>	...
Eje Tarjeta de Dirección	12L-4-170		...	...	010	<b>83158</b>	...
	654789		...	...	010	<b>83158</b>	...
MC5, MC7, MC8	12B-5-1	010	<b>85735</b>				
	3178157	010	<b>85700</b>				
	680323	010	<b>85700</b>				
Modelos de Autobús Piso Bajo con Número de E.O.	12L-5-99		...	...	010	<b>85339</b>	...

#### Series D - Coaches

Autobús DL3 - Eje Motriz	12J-5-10		...	...	01-	<b>85733</b>	...
Autobús DL3 - Eje Tarjeta	12L-5-100		...	...	-1-	<b>85727</b>	...
	12L-5-114		...	...	-1-	<b>85727</b>	...
Autobús Modelo DL3	12L-5-88		...	...	01-	<b>85729</b>	...
	12L-5-89		...	...	01-	<b>85729</b>	...
	12L-5-96	-1-	<b>85728</b>	...		...	...
	12L-5-97	-1-	<b>85728</b>	...		...	...
D 4000 Autobús Foráneo (Eje Delantero)  (Eje Motriz) (Eje Secundario)	12-05-1176	-1-	<b>85728</b>	...		...	...
	12L-5-97	-1-	<b>85728</b>	...		...	...
	12-05-1177		...	...	01-	<b>85729</b>	...
	12-05-1178		...	...	010	<b>85339</b>	...
	12-05-1194		...	...	010	<b>85339</b>	...
	12L-5-99		...	...	010	<b>85339</b>	...
D 4005 Autobús Foráneo (Eje Delantero)  (Eje Motriz) (Eje Secundario)	12-05-1176	-1-	<b>85728</b>	...		...	...
	12L-5-97	-1-	<b>85728</b>	...		...	...
	12-05-1177		...	...	01-	<b>85729</b>	...
	12-05-1194		...	...	010	<b>85339</b>	...
	12L-5-99		...	...	010	<b>85339</b>	...
D 4500 Autobús Foráneo (Eje Delantero)  (Eje Motriz)  (Eje Secundario)	12-05-1176	-1-	<b>85728</b>	...		...	...
	12L-5-67	-1-	<b>85728</b>	...		...	...
	12-05-1177		...	...	01-	<b>85729</b>	...
	12L-5-88		...	...	01-	<b>85729</b>	...
	85729		...	...	01-	<b>85729</b>	...
	12-05-1179		...	...	-1-	<b>85727</b>	...
	12L-5-114		...	...	-1-	<b>85727</b>	...
D 4505 Autobús Foráneo (Eje Delantero)  (Eje Motriz)  (Eje Secundario)	12-05-1176	-1-	<b>85728</b>	...		...	...
	12L-5-67	-1-	<b>85728</b>	...		...	...
	12-05-1177		...	...	01-	<b>85729</b>	...
	12L-5-88		...	...	01-	<b>85729</b>	...
	12-05-1179		...	...	-1-	<b>85727</b>	...
	12L-5-114		...	...	-1-	<b>85727</b>	...

**GUÍA DE APLICACIONES – CAMIONES, TRÁILERS Y AUTOBUSES**

Año	Modelo	# E.O.	Delantero		Trasero	
						
			Fleetline	GasSLX	Fleetline	GasSLX

**MOTOR COACH INDUSTRIES (Cont.)**

**Series E - Coaches (Cont.)**

Autobús Foráneo E 4500 (Eje Delantero)  (Eje Motriz)     (Eje Secundario)	12-05-1150	-10	85711	...		...	...
	12-05-1165	-10	85711	...		...	...
	12-05-1022		...	...	01-	85970	...
	12-05-1102		...	...	01-	85970	...
	12-05-1138		...	...	01-	85970	...
	12-05-1148		...	...	01-	85970	...
	12-05-1188		...	...	01-	85970	...
	12-05-1139		...	...	01-	85341	...
	12-05-1147		...	...	01-	85341	...
	12-05-1166		...	...	01-	85341	...

**Series G - Coaches**

Autobús Foráneo G 4500	1497835	-10	85711	...		...	...
Autobús Foráneo G 4500 (Eje Delantero)  (Eje Motriz)  (Eje Secundario)  (Eje Tarjeta) Autobús Foráneo de 45 ft - Eje Secundario	12-05-6000	-10	85711	...		...	...
	12-05-6053	-10	85711	...		...	...
	12-05-6001		...	...	01-	85740	...
	12-05-6054		...	...	01-	85740	...
	12-05-6002		...	...	010	85339	...
	12-05-6055		...	...	010	85339	...
	1498565		...	...	010	85339	...
	12-05-6033		...	...	010	85339	...

**Series J - Coaches**





Autobús Foráneo J 4500 (Eje Motriz)    (Eje Secundario)   Eje Delantero con Número de E.O.	12-05-1022		...	...	01-	85970	...
	12-05-1138		...	...	01-	85970	...
	12-05-1148		...	...	01-	85970	...
	12-05-1188		...	...	01-	85970	...
	12-05-1139		...	...	01-	85341	...
	12-05-1147		...	...	01-	85341	...
	12-05-1166		...	...	01-	85341	...
	12-05-1137	01-	85340	...		...	...
	12-05-1142	01-	85340	...		...	...
	12-05-1146	01-	85340	...		...	...
	12-05-1150	-10	85711	...		...	...
	12-05-1165	-10	85711	...		...	...
	12-05-1228	-10	85711	...		...	...

**Intercambios Adicionales de E.O.**

Modelos con Número de E.O.	12-05-1021	01-	85340	...		...	...
	12-05-1023		...	...	01-	85341	...
	12-05-1101	01-	85340	...		...	...
	12-05-1103		...	...	01-	85341	...
	12-05-1137	01-	85340	...		...	...
	12-05-1170	01-	85340	...		...	...
	12-05-1199		...	...	01-	85729	...
	12-05-1228	-10	85711	...		...	...
	12-05-1242	-1-	85728	...		...	...
	12-05-1243		...	...	01-	85729	...
	12-05-1244		...	...	-1-	85727	...
	12-5-1-G	010	85700	...		...	...
	12-5-1-GS	010	85700	...		...	...
	12B-5-1-G	010	85700	...		...	...
	12B-5-1-GS	010	85700	...		...	...
	12J-5-10GS		...	...	01-	85733	...



**GUÍA DE APLICACIONES – CAMIONES, TRÁILERS Y AUTOBUSES**





Año	Modelo	# E.O.	Delantero		Trasero	
						
			Fleetline	GasSLX	Fleetline	GasSLX

**MOTOR COACH INDUSTRIES (Cont.)**

**Intercambios Adicionales de E.O. (Cont.)**

Modelos con Número de E.O.	12L-5-58	-1-	85728	...		...	...	
	12L-5-69	010	85700	...		...	...	
	12L-5-98		...	...	010	85339	...	
	12T-1-13	010	85303 or 89422					
	12TA-01-013	010	85303 or 89422					
	1498200		...	...	01-	85740	...	
	22012067	010	85700	...		...	...	
	22024061		...	...	010	85704	...	
	22045526		...	...	010	85702	...	
	22046485	-10	85710	...		...	...	
	3178154		...	...	010	85735	...	
	4975515	-1-	85701	...		...	...	
	4975515GS	-1-	85701	...		...	...	
	5316984	010	85313					
	63-0127GS	010	85303 or 89422					
	680231		...	...	010	85313	...	
	680232		...	...	01-	85733	...	
	680322		...	...	010	85704	...	
	680323	010	85700	...		...	...	
	680350	-10	85710	...		...	...	
	680369		...	...	-1-	85708	...	
	680374	-1-	85728	...		...	...	
	680441		...	...	01-	85729	...	
	680452		...	...	010	85339	...	
	680462	-1-	85728	...		...	...	
	680470		...	...	010	85713	...	
	680482		...	...	-1-	85727	...	
	680485		...	...	01-	85733	...	
	680544	-10	85711	...		...	...	
	680546		...	...	010	85339	...	
	680602		...	...	010	85339	...	
	680677	-1-	85728	...		...	...	
	680680		...	...	01-	85729	...	
	680681		...	...	-1-	85727	...	
	695125		...	...	010	85704	...	
	97-9999-02585	01-	85723	...		...	...	
	G1101590		...	...	010	85713	...	
	G1201338	-10	85710	...		...	...	
	G1201339		...	...	010	85702	...	
	G5008069	010	85700	...		...	...	
OE10086S		...	...	010	85702	...		
OE10881	-10	85711	...		...	...		
OE10882		...	...	01-	85740	...		
OE10883		...	...	010	85339	...		
T14-1029	-1-	85701	...		...	...		
T14-1045GS	010	85700	...		...	...		
T14-1048		...	...	010	85302	89420		
T14-1080	-1-	85728	...		...	...		
Intercambios Adicionales de E.O.	12G-5-1	010	85700					
	12J-5-6	010	85313					
	12J-5-7	01-	85312					
	12J-5-71	01-	85733					
	12J-5-9	010	85700					
	12L-5-70	010	85700					
	22012066	-1-	85707					

**GUÍA DE APLICACIONES – CAMIONES, TRÁILERS Y AUTOBUSES**

Año	Modelo	# E.O.	Delantero		Trasero	
						
			Fleetline	GasSLX	Fleetline	GasSLX

**MOTOR COACH INDUSTRIES (Cont.)**

**Intercambios Adicionales de E.O. (Cont.)**

Intercambios Adicionales de E.O.	22012079	- -	85701
	22052014	0 0	85702
	6314933	- -	85708
	680332	- -	85701
	680333	- -	85708
	690029	0 0	85700
	97-2201-00151	0 0	85700
	97-2210-00164	- -	85708
	97-9999-02514	0 0	85700
	97-9999-02634	0 -	85733

**MUNCIE RECLAMATION**

**Intercambios Adicionales de E.O.**

Modelos con Número de E.O.	665459		...	...	- -	89447	...
	665568		...	...	0 0	85051	...
	H53-20415-006		...	...	0 0	85051	...
	MR6394	0 -	85723	...		...	...
Intercambios Adicionales de E.O.	665569	0 0	85045				
	680334	- -	85709				
	97-2210-00164	- -	85708				
	H53-21144-004	0 0	85045				
	MR1623	0 0	85700				
	MR1710	0 0	85713				
	MR1751	0 0	85713				
	MR1763	0 0	85300 or 89419				
	MR1765	0 0	85713				
	MR25767	0 0	85702				
	MR2960	0 0	85702				
	MR2961	- -	85701				
	MR2996	0 0	85704				
	MR2997	- 0	85703				
	MR3303	- -	85709				
	MR3304	- 0	85710				
	MR3304H	- -	85709				
	MR3306	- -	85705 or 89447				
	MR3307	- -	85707				
	MR3650	- -	85707				
MR6396	- -	85982					
MR6535	- -	85708					
MR6536	- -	85722					
MR7388	- 0	85710					

**NATIONAL COACH CORP**

Autobús Foráneo El Dorado RE-29	C800853	0 0	83207	89407		...	...
---------------------------------	---------	-----	-------	-------	--	-----	-----

**NAVISTAR - SEE INTERNATIONAL (NAVISTAR)**

--	--	--	--	--	--	--	--

**NEOPLAN BUS**

Mini-Bus	24-1700-106-149		...	...	0 0	83216	...
	24-1700-999-362	- 0	85009	...		...	...
	BN1002002	- 0	85009	...		...	...
	BT1002011		...	...	0 0	83216	...
Modelos 40	25-1700-101-426	- -	85705 or 89447				

## GUÍA DE APLICACIONES – CAMIONES, TRÁILERS Y AUTOBUSES

Año	Modelo	# E.O.	Delantero		Trasero	
			Fleetline	GasSLX	Fleetline	GasSLX

### NEOPLAN BUS (Cont.)

	Modelos 40	DT1002002	- -	<b>85707</b>
	Modelos 80B	CL1002003	- -	<b>85705 or 89447</b>
		DZ1002002	- -	<b>85705 or 89447</b>
	Modelos con Número de E.O.	680307	- -	<b>85705 or 89447</b>
		680308	- -	<b>85706</b>
		AA1002002	- -	<b>85705 or 89447</b>
		AA1002003	- -	<b>85705 or 89447</b>
		AA1802002	- -	<b>85705 or 89447</b>
		AC1002002	- -	<b>85705 or 89447</b>
		AC1002002GS	- -	<b>85705 or 89447</b>
		AC1002003	- -	<b>85705 or 89447</b>
		DT1802002	- -	<b>85705 or 89447</b>
		GJ1002002	- -	<b>85706</b>
		GJ1002003	- -	<b>85705 or 89447</b>
	MM1002002	- -	<b>85705 or 89447</b>	
	MM1002003	- -	<b>85705 or 89447</b>	
	Intercambios Adicionales de E.O.	97-9999-02519	- -	<b>85707</b>
		CI 1002003	- -	<b>85705 or 89447</b>

### NEW FLYER

	Autobús Foráneo de Piso Bajo a Diesel	015813		...	...	- -	<b>85708</b>	...
<b>01 - 11</b>	Autobús Urbano (Perfil Bajo) con Número de E.O.	203398	- -	<b>85346</b>	...		...	...
		204428		...	...	- -	<b>85347</b>	...
<b>02 -</b>	Autobús Urbano (Perfil Bajo) con Número de E.O.	152959		...	...	- -	<b>85708</b>	...
		680671		...	...	- -	<b>85708</b>	...
<b>91 -</b>	Autobús Urbano (Perfil Bajo) con Número de E.O.	009863	- -	<b>85722</b>	...		...	...
		016415	- -	<b>85722</b>	...		...	...
		680346	- -	<b>85722</b>	...		...	...
	Modelos con Número de E.O.	G1011823	- O	<b>85710</b>	...		...	...
	Intercambios Adicionales de E.O.	015915	- O	<b>85711</b>				
		064845	- O	<b>85711</b>				
		680352	- O	<b>85711</b>				
		690102	- O	<b>85711</b>				
		97-2210-00164	- -	<b>85708</b>				

### NEWAY (HOLLAND) SUSPENSION SYSTEMS-SEE SAF HOLLAND





Ver Sección de SAF Holland para información de aplicación

### NEWMAR CORP

#### MotorHomes Clase A

<b>02 - 04</b>	MotorHomes Series Dutch Star & Moundain Aire con Chasis Freightliner XC Amortiguador Trasero con Número de E.O.  Suspensión Delantera AS120	141700131809						
		16-16736-000		...	...	O O	<b>85029</b>	...
		141700131810	O O	<b>83160</b>	...		...	...
		16-16737-000	O O	<b>83160</b>	...		...	...
		16-16874-000	O O	<b>83160</b>	...		...	...
		16-18103-000	- -	<b>85900</b>	...		...	...
		481700000493	- -	<b>85900</b>	...		...	...
<b>02 - 05</b>	MotorHomes Series Kountry Star con Chasis Freightliner XC Amortiguador Trasero con Número de E.O.  Suspensión Delantera AS120	141700131809						
		16-16736-000		...	...	O O	<b>85029</b>	...
		141700131810	O O	<b>83160</b>	...		...	...
		16-16737-000	O O	<b>83160</b>	...		...	...
		16-16874-000	O O	<b>83160</b>	...		...	...

**GUÍA DE APLICACIONES – CAMIONES, TRÁILERS Y AUTOBUSES**

Año	Modelo	# E.O.	Delantero		Trasero	
						
			Fleetline	GasSLX	Fleetline	GasSLX

**NEWMAR CORP (Cont.)**

**MotorHomes Clase A (Cont.)**

	Suspensión Delantera ZF - IFS con PBV de 23,000 lb o mayor	16-18103-000	- -	<b>85900</b>	...		...	...
		481700000493	- -	<b>85900</b>	...		...	...
<b>06</b>	MotorHomes Series Ventana con Chasis Freightliner XC Amortiguador Trasero con Número de E.O.	141700131809		...		o o	<b>85029</b>	...
		16-16736-000		...		o o	<b>85029</b>	...
	Suspensión Delantera AS120	141700131810	o o	<b>83160</b>	...		...	...
		16-16737-000	o o	<b>83160</b>	...		...	...
		16-16874-000	o o	<b>83160</b>	...		...	...
	Suspensión Delantera ZF - IFS con PBV de 23,000 lb o mayor	16-18103-000	- -	<b>85900</b>	...		...	...
		481700000493	- -	<b>85900</b>	...		...	...

**NISSAN**

**Series UD 1300**

	Eje de Dirección Modelos UD 1300	56110-T8123	- o	<b>G63432</b>	...		...	...
		56110-T8129	- o	<b>G63432</b>	...		...	...
		66400	- o	<b>G63432</b>	...		...	...

**Series UD 1800**

<b>11 - 13</b>	Modelos con Número de E.O.	56101-30Z01	- o	<b>83161</b>	...		...	...
		56101-30Z02	o -	<b>G63610</b>	...		...	...
		56110-30Z01	- o	<b>83161</b>	...		...	...
		56110-30Z02	o -	<b>G63610</b>	...		...	...
<b>89 - 94</b>	Modelos con Número de E.O.	56101-Z5008	- o	<b>83114</b>	...		...	...
		56110-Z5008	- o	<b>83114</b>	...		...	...
<b>95 - 98</b>	Modelos con Número de E.O.	56101-30Z01	- o	<b>83161</b>	...		...	...
		56101-30Z02	o -	<b>G63610</b>	...		...	...
		56110-30Z01	- o	<b>83161</b>	...		...	...
		56110-30Z02	o -	<b>G63610</b>	...		...	...

**Series UD 18CS**

<b>05 - 10</b>	Modelos con Número de E.O.	56101-30Z01	- o	<b>83161</b>	...		...	...
		56110-30Z01	- o	<b>83161</b>	...		...	...
<b>99 - 04</b>	Modelos con Número de E.O.	56101-Z5008	- o	<b>83114</b>	...		...	...
		56110-Z5008	- o	<b>83114</b>	...		...	...
		56201-Z5001		...	...	- -	<b>85085</b>	...
		56210-Z5001		...	...	- -	<b>85085</b>	...









**Series UD 18HD**

<b>99 - 10</b>	Modelos con Número de E.O.	56101-30Z01	- o	<b>83161</b>	...		...	...
		56101-30Z02	o -	<b>G63610</b>	...		...	...
		56110-30Z01	- o	<b>83161</b>	...		...	...
		56110-30Z02	o -	<b>G63610</b>	...		...	...

**Series UD 2000**

	Modelos con Número de E.O.	56110-Z5011	- o	<b>G63610</b>	...		...	...
<b>89 - 94</b>	Modelos U D 2000 con Número de E.O.	56101-Z5008	- o	<b>83114</b>	...		...	...
		56110-Z5008	- o	<b>83114</b>	...		...	...
<b>95 - 13</b>	Modelos U D 2000 con Número de E.O.	56101-30Z01	- o	<b>83161</b>	...		...	...
		56101-30Z02	o -	<b>G63610</b>	...		...	...
		56110-30Z01	- o	<b>83161</b>	...		...	...
		56110-30Z02	o -	<b>G63610</b>	...		...	...
<b>89 - 13</b>	Modelos U D 2600 con Número de E.O.	56101-Z5017	- o	<b>83162</b>	...		...	...
		56110-Z5017	- o	<b>83162</b>	...		...	...
<b>92 - 94</b>	Modelos U D 2600 con Número de E.O.	56201-Z5001		...	...	- -	<b>85085</b>	...
		56210-Z5001		...	...	- -	<b>85085</b>	...
<b>89 - 94</b>	Modelos U D 2800 con Número de E.O.	56101-Z5017	- o	<b>83162</b>	...		...	...
		56110-Z5017	- o	<b>83162</b>	...		...	...

## GUÍA DE APLICACIONES – CAMIONES, TRÁILERS Y AUTOBUSES

Año	Modelo	# E.O.	Delantero		Trasero	
						
						
			Fleetline	GasSLX	Fleetline	GasSLX

### NISSAN (Cont.)

#### Series UD 2000 (Cont.)

92 - 94	Modelos U D 2800 con Número de E.O.	56201-Z5001		...	...	- -	<b>85085</b>	...
		56210-Z5001		...	...	- -	<b>85085</b>	...

#### Series UD 23DH

95 - 13	Modelos con Número de E.O.	56101-30Z01	- O	<b>83161</b>	...		...	...
		56101-30Z02	O -	<b>G63610</b>	...		...	...
		56110-30Z01	- O	<b>83161</b>	...		...	...
		56110-30Z02	O -	<b>G63610</b>	...		...	...

#### Series UD 23LP

95 - 13	Modelos con Número de E.O.	56101-30Z01	- O	<b>83161</b>	...		...	...
		56101-30Z02	O -	<b>G63610</b>	...		...	...
		56110-30Z01	- O	<b>83161</b>	...		...	...
		56110-30Z02	O -	<b>G63610</b>	...		...	...

#### Series UD 3000

89 - 91	Modelos U D 3000 con Número de E.O.	56101-Z5017	- O	<b>83162</b>	...		...	...
		56110-Z5017	- O	<b>83162</b>	...		...	...
95 - 00	Modelos U D 3000 con Número de E.O.	56101-Z5017	- O	<b>83162</b>	...		...	...
		56110-Z5017	- O	<b>83162</b>	...		...	...
89 - 94	Modelos U D 3300 con Número de E.O.	56101-Z5017	- O	<b>83162</b>	...		...	...
		56110-Z5017	- O	<b>83162</b>	...		...	...
92 - 94	Modelos U D 3300 con Número de E.O.	56201-Z5001		...	...	- -	<b>85085</b>	...
		56210-Z5001		...	...	- -	<b>85085</b>	...
99 - 13	Modelos U D 3300 con Número de E.O.	56101-Z5017	- O	<b>83162</b>	...		...	...
		56110-Z5017	- O	<b>83162</b>	...		...	...
		56201-Z5001		...	...	- -	<b>85085</b>	...
		56210-Z5001		...	...	- -	<b>85085</b>	...





#### Aplicaciones Adicionales

92 - 94	Modelos 30HD con Número de E.O.	56101-Z5017	- O	<b>83162</b>	...		...	...
		56110-Z5017	- O	<b>83162</b>	...		...	...
		56201-Z5001		...	...	- -	<b>85085</b>	...
		56210-Z5001		...	...	- -	<b>85085</b>	...
92 - 94	Modelos 30SD con Número de E.O.	56101-Z5017	- O	<b>83162</b>	...		...	...
		56110-Z5017	- O	<b>83162</b>	...		...	...
		56201-Z5001		...	...	- -	<b>85085</b>	...
		56210-Z5001		...	...	- -	<b>85085</b>	...
89 - 91	Modelos 500T con Número de E.O.	56101-Z5017	- O	<b>83162</b>	...		...	...
		56110-Z5017	- O	<b>83162</b>	...		...	...
92 - 94	Modelos 600T con Número de E.O.	56101-Z5017	- O	<b>83162</b>	...		...	...
		56110-Z5017	- O	<b>83162</b>	...		...	...
		56201-Z5001		...	...	- -	<b>85085</b>	...
		56210-Z5001		...	...	- -	<b>85085</b>	...

### NOVA BUS

	Autobús Modelo RTS	22012079	- -	<b>85701</b>	...		...	...
		22045526		...	...	O O	<b>85702</b>	...
		22052014		...	...	O O	<b>85702</b>	...
		4975515	- -	<b>85701</b>	...		...	...
		695117	- -	<b>85701</b>	...		...	...
		74410	- -	<b>85701</b>	...		...	...
		G1011822		...	...	O O	<b>85702</b>	...
		G1203223		...	...	O O	<b>85702</b>	...
		G1205763	O O	<b>87019</b>	...		...	...
		G1205763-001	O O	<b>87019</b>	...		...	...
		OE 10086S		...	...	O O	<b>85702</b>	...
		Autobús RTS con "V" Drive	G1011823	- O	<b>85710</b>	...		...

**GUÍA DE APLICACIONES – CAMIONES, TRÁILERS Y AUTOBUSES**

Año	Modelo	# E.O.	Delantero		Trasero	
						
			Fleetline	GasSLX	Fleetline	GasSLX

**NOVA BUS (Cont.)**

	Autobús RTS con "V" Drive	G1101590		...	...	010	<b>85713</b>	...
	Autobús RTS con Eje Delantero Rígido	22024673	-10	<b>85710</b>	...		...	...
	Classic Bus con Número de E.O.	97-2201-00151	010	<b>85700</b>				
	Modelos de Autobús Piso Bajo con Número de E.O.	481700131250	010	<b>85377</b>	...		...	...
		481700131252		...	...	010	<b>85378</b>	...
		680480	010	<b>85377</b>	...		...	...
		N16248	010	<b>85377</b>	...		...	...
		N16249		...	...	010	<b>85378</b>	...
		N21543		...	...	010	<b>85378</b>	...
		N31830		...	...	010	<b>85378</b>	...
		N31831	010	<b>85377</b>	...		...	...
	Modelos con Número de E.O.	12J-5-10		...	...	01-	<b>85733</b>	...
		12J-5-11		...	...	010	<b>85313</b>	...
		680231		...	...	010	<b>85313</b>	...
		680232		...	...	01-	<b>85733</b>	...
		680323	010	<b>85700</b>	...		...	...
		680326	010	<b>85700</b>	...		...	...
		680470		...	...	010	<b>85713</b>	...
		680481		...	...	010	<b>85378</b>	...
		G1201338	-10	<b>85710</b>	...		...	...
		G1201339		...	...	010	<b>85702</b>	...
		G5008070	010	<b>85700</b>	...		...	...
		N22212	010	<b>85700</b>	...		...	...
	Intercambios Adicionales de E.O.	97-9999-02514	010	<b>85700</b>				

**OLE GRANNING**

	Modelos con Número de E.O.	1086	010	<b>83217</b>	...		...	...
--	----------------------------	------	-----	--------------	-----	--	-----	-----

**ONEIDA PRODUCTS**

	Autobús Escolar con Suspensión Estándar	.....	010	<b>83216</b>				
	Autobús Escolar con Suspensión Heavy Duty	.....	010	<b>85307</b>				





**OPTIMA BUS CORP**

	Autobuses con Suspensión de Aire en Eje de Dirección Ridewell RAS - 227 con Número de E.O.	1260008		...	...	010	<b>87017</b>	...
		90-2610-SP1		...	...	010	<b>87017</b>	...

**ORION BUS INDUSTRIES**

	Modelos Orion VII con Número de E.O.	070131502	-10	<b>87016</b>	...		...	...
		070131506	-10	<b>87016</b>	...		...	...
		070231514		...	...	01-	<b>85729</b>	...
	Orion 1	010134505-4	010	<b>85715</b>	...		...	...
		010134509	010	<b>85717</b>	...		...	...
		010234503-4		...	...	010	<b>85308</b>	<b>89422</b>
		010234506		...	...	010	<b>85714</b>	...
	Orion 102	050134501-4	010	<b>85716</b>	...		...	...
		050230501		...	...	010	<b>85716</b>	...
		050231505		...	...	010	<b>85716</b>	...
		680504		...	...	010	<b>85716</b>	...
	Orion II	010134505-4	010	<b>85715</b>	...		...	...
		010234503-4		...	...	010	<b>85308</b>	<b>89422</b>
		020117504	010	<b>85720</b>	...		...	...
		020273541	010	<b>83203</b>	<b>89436</b>		...	...
		020273541-4		...	...	010	<b>85000</b>	<b>89436</b>
		020273544	010	<b>83203</b>	<b>89436</b>		...	...
		020273546		...	...	010	<b>85719</b>	...

**GUÍA DE APLICACIONES – CAMIONES, TRÁILERS Y AUTOBUSES**

Año	Modelo	# E.O.	Delantero		Trasero	
						
			Fleetline	GasSLX	Fleetline	GasSLX

**ORION BUS INDUSTRIES (Cont.)**

	Orion II	020273547		...	...	010	<b>85719</b>	...
		020273548		...	...	010	<b>85719</b>	...
		020273549		...	...	010	<b>85719</b>	...
		20117501	010	<b>85720</b>	...			...
		20117503	010	<b>85720</b>	...			...
		20117504	010	<b>85720</b>	...			...
		20117505	010	<b>85720</b>	...			...
	Orion V	010134508-4	010	<b>85718</b>	...			...
		050134502-4	010	<b>85718</b>	...			...
		050134506-4	010	<b>85718</b>	...			...
		050134509	010	<b>85732</b>	...			...
		050134510	010	<b>85732</b>	...			...
		050134513	010	<b>85732</b>	...			...
		050231505		...	...	010	<b>85716</b>	...
		680504		...	...	010	<b>85716</b>	...
	Orion VI (Eje M) con Número de E.O.	060131507	-10	<b>87016</b>	...			...
		060131508	-10	<b>87016</b>	...			...
	Orion VI (Piso Bajo)	060231508	010	<b>85717</b>	...			...
	Orion VII - Parte Trasera de 30 ft	070231527		...	...	01-	<b>85729</b>	...
	Modelos con Número de E.O.	665596		...	...	010	<b>85719</b>	...
		680271		...	...	010	<b>85714</b>	...
		680274		...	...	010	<b>85716</b>	...
		680328	010	<b>85717</b>	...			...
		680378	010	<b>85720</b>	...			...
		695327	010	<b>85732</b>	...			...
		695343	010	<b>85732</b>	...			...
		695366	010	<b>85732</b>	...			...
		695389	-10	<b>87016</b>	...			...
		695420		...	...	01-	<b>85729</b>	...
		695421	-10	<b>87016</b>	...			...
		695440		...	...	01-	<b>85729</b>	...
			Intercambios Adicionales de E.O.	010134501-4	010			
010134504-4	010						<b>85715</b>	
010134506-4	010						<b>85717</b>	
020273547-4	010						<b>85719</b>	
050134508	010						<b>85718</b>	
0501345-11	010						<b>85718</b>	
050231502-4	010						<b>85716</b>	
050231507	010						<b>85716</b>	
680091	010						<b>85303 or 89422</b>	
680102	010						<b>85712</b>	
680352	-10						<b>85711</b>	
680501	010						<b>85714</b>	
680502	010						<b>85715</b>	
680505	010						<b>85717</b>	
680506	010						<b>85718</b>	
690102	-10						<b>85711</b>	
97-9999-02635	010						<b>85718</b>	
97-9999-02636	010						<b>85716</b>	
A-4890	010						<b>85712</b>	
OB020570	-10				<b>85711</b>			
OB020764	010				<b>85716</b>			
OB3166657	010				<b>85700</b>			

## GUÍA DE APLICACIONES – CAMIONES, TRÁILERS Y AUTOBUSES

Año	Modelo	# E.O.	Delantero		Trasero	
			Fleetline	GasSLX	Fleetline	GasSLX

### OSHKOSH MOTORS

	Autobús Foráneo V - Line	1573280		...	...	OIO	<b>83221</b>	...
	Camper - ForeTravel	1583470		...	...	OIO	<b>85051</b>	...
	Modelos con Amortiguador Largo de 16" con Pernos de Montaje de 1"	....	OIO	<b>85303</b>	89422		...	...
	Modelos con Pernos de Montaje de 3/4"	....	OIO	<b>83122</b>	89406		...	...
	Modelos con Suspensión de Aire Neway	90044448		...	...	OIO	<b>85051</b>	...
	Motor Homes con Número de E.O.	1398980	OIO	<b>83127</b>				
		GBL654875		...	...	OIO	<b>83117</b>	...
		RW24285	OIO	<b>83119</b>	...		...	...
	Modelos con Número de E.O.	12405F	OIO	<b>85734</b>	...		...	...
		12405F-1	OIO	<b>85303</b>	89422		...	...
		1583470		...	...	OIO	<b>85051</b>	...
		3638112		...	...	OIO	<b>G63183</b>	...
		4036892	OIO	<b>G63605</b>	...		...	...
		5353054	OIO	<b>85303</b>	89422		...	...
		5361994	OIO	<b>85734</b>	...		...	...
		651444		...	...	OIO	<b>83221</b>	...
		665040	OIO	<b>85303</b>	89422		...	...
		690049	OIO	<b>85303</b>	89422		...	...
		GBL654918	OIO	<b>83118</b>	...		...	...
		P117099		...	...	OIO	<b>83120</b>	...
		P117146	OIO	<b>83118</b>	...		...	...
	Intercambios Adicionales de E.O.	12405FX1	OIO	<b>85303 or 89422</b>				
		1445910	OIO	<b>85300 or 89419</b>				
		1573270	OIO	<b>83207 or 89407</b>				
		1745500	OIO	<b>89430</b>				
		2173340	OIO	<b>85303 or 89422</b>				
		26228-A	OIO	<b>83122 or 89406</b>				
		2JD137	OIO	<b>83119</b>				
		40-0242	OIO	<b>83312 or 89409</b>				
		40-4845	OIO	<b>85304</b>				
		40-4951	-IO	<b>85316 or 89426</b>				
		40-5348	OIO	<b>85058 or 89431</b>				
		40-6967	OIO	<b>85030 or 89440</b>				
		665060	OIO	<b>83122 or 89406</b>				

### OSHKOSH MOTORS AMORTIGUADORES DE CABINA

	Modelos con Modelo Link Cabmate OKTP con Número de E.O.	1202-0054	OIO	<b>83021</b>				
	Modelos con Número de E.O.	2218640	OIO	<b>83009</b>				

### OSTERLUND TRUCK









	Modelos con Número de E.O.	59011	OIO	<b>83214</b>	...		...	...
		680117	OIO	<b>85300</b>	89419		...	...
	Intercambios Adicionales de E.O.	220-S5-10		...	...	OIO	<b>85712</b>	...

### OTTAWA TRUCK

	Tracto de Patio	59009	OIO	<b>83217</b>				
	Modelos con Número de E.O.	59011	OIO	<b>83214</b>	...		...	...
		680117	OIO	<b>85300</b>	89419		...	...
	Intercambios Adicionales de E.O.	53540451	OIO	<b>85300 or 89419</b>				
		90013787	-IO	<b>85310 or 89423</b>				
		9007342	OIO	<b>85303 or 89422</b>				
	Tracto de Patio	90027577	OIO	<b>85720</b>	...		...	...



## GUÍA DE APLICACIONES – CAMIONES, TRÁILERS Y AUTOBUSES

Año	Modelo	# E.O.	Delantero		Trasero	
						
						
			Fleetline	GasSLX	Fleetline	GasSLX

### PACCAR

#### Aplicaciones Adicionales

Amortiguador TruckMaster con Número Estampado	665633		...	...	-10	<b>85033</b>	89427
---	--------	--	-----	-----	-----	--------------	-------

### PACIFIC TRUCK & TRAILER

Intercambios Adicionales de E.O.	3178157C	010	<b>85735</b>				
	507202C1	010	<b>85030 or 89440</b>				

### PAGE SUSPENSION

Modelo con Suspensión de Eje Levantado LM-2000	1080099		...	...	010	<b>83203</b>	89436
Modelo con Suspensión de Muelles Trailmaster	1081933		...	...	010	<b>83204</b>	...
	A-2212		...	...	010	<b>85029</b>	...
Modelos con Número de E.O.	665133		...	...	010	<b>83203</b>	89436
	665267		...	...	010	<b>85029</b>	...

### PAI CORP

Modelos con Número de E.O.	HSA-5067	010	<b>85305</b>	...		...	...
	HSA-5080	010	<b>83221</b>	...		...	...
	HSA-5095	010	<b>83215</b>	...		...	...

### PEERLESS TRAILER





Modelos con Número de E.O.	120-1		...	...	010	<b>83125</b>	...
Modelos con Suspensión de Aire	72-61		...	...	010	<b>83125</b>	...

### PETERBILT

#### Aplicaciones Adicionales

Amortiguador TruckMaster con Número Estampado	665632	010	<b>85013</b>	89414		...	...
	665633		...	...	-10	<b>85033</b>	89427
	665783		...	...	010	<b>83123</b>	89405
	665784		...	...	010	<b>83122</b>	89406
	665785		...	...	010	<b>83137</b>	...
	665844		...	...	-1-	<b>85069</b>	89455
	665918		...	...	-1-	<b>85900</b>	...
	665926		...	...	010	<b>85047</b>	89435
	665927		010	<b>85901</b>	...		...
	665928		010	<b>85062</b>	89408		...
	665930		010	<b>85001</b>	89410		...
	665931		010	<b>83312</b>	89409		...
	665932		010	<b>85012</b>	89413		...
	665950		...	...	-1-	<b>85902</b>	...
	671052		010	<b>85070</b>	89459		...
	671654		...	...	01-	<b>85936</b>	89456
	671699		...	...	01-	<b>85937</b>	...
	671794		...	...	010	<b>85067</b>	89451
	680237		...	...	010	<b>85303</b>	89422
	680239		...	...	-1-	<b>85310</b>	89423
	680240		...	...	010	<b>85302</b>	89420
	680242		...	...	010	<b>85308</b>	89422
	680253		...	...	010	<b>85314</b>	89425
	680261		010	<b>85062</b>	89408		...
	680279		010	<b>83209</b>	89414		...
	680280		...	...	010	<b>85906</b>	89407
	680281		...	...	010	<b>85003</b>	89411
	680283		01-	<b>83353</b>	...		...
	680303		...	...	010	<b>85007</b>	89412
	680425		010	<b>85320</b>	89429		...

**GUÍA DE APLICACIONES – CAMIONES, TRÁILERS Y AUTOBUSES**









Año	Modelo	# E.O.	Delantero		Trasero	
						
			Fleetline	GasSLX	Fleetline	GasSLX

**PETERBILT (Cont.)**

**Aplicaciones Adicionales (Cont.)**

Amortiguador TruckMaster con Número Estampado	680435		...	...	-10	<b>85033</b>	89427
	680473		...	...	-10	<b>85319</b>	89428
	680586		...	...	-10	<b>85311</b>	89424
Modelos con Suspensión Trasera de 4 Muelles Quadraflex	03-04628		...	...	-1-	<b>85336</b>	...
Número de Estampado de Amortiguador EO PLUS	02-02736PLUS	010	<b>85302</b>	89420		...	...
	02-02737PLUS	010	<b>85062</b>	89408		...	...
	02-02738PLUS	010	<b>85012</b>	89413		...	...
	02-02739PLUS	010	<b>85013</b>	89414		...	...
	03-04176PLUS		...	...	010	<b>85308</b>	89422
	03-06084PLUS		...	...	-10	<b>85033</b>	89427
	03-07421PLUS		...	...	-10	<b>85311</b>	89424
	03-07423PLUS		...	...	-10	<b>85033</b>	89427
	10-12032-002PLUS	010	<b>85320</b>	89429		...	...
	10-12542-000PLUS	010	<b>85901</b>	...		...	...
	16-13947-000PLUS		...	...	-10	<b>85319</b>	89428
	2018987C1PLUS		...	...	010	<b>85003</b>	89411
	47902-13PLUS		...	...	010	<b>83122</b>	89406
	60670-005PLUS		...	...	010	<b>83121</b>	...
	60670-008PLUS		...	...	010	<b>83123</b>	89405
	665565PLUS		...	...	010	<b>85007</b>	89412
	671962PLUS		...	...	01-	<b>85936</b>	89456
	70701PLUS		...	...	-1-	<b>85900</b>	...
	8086053PLUS		...	...	010	<b>85047</b>	89435
	90044025PLUS	010	<b>83209</b>	89414		...	...
	90044089PLUS		...	...	010	<b>83124</b>	89407
	B71-6015	010	<b>85012</b>	89413		...	...
	C71-1002PLUS		...	...	010	<b>85067</b>	89451
	C71-1011PLUS		...	...	-1-	<b>85069</b>	89455
	K374-26PLUS	010	<b>85001</b>	89410		...	...
	K374-28PLUS		...	...	010	<b>85314</b>	89425
	K374-29PLUS		...	...	-1-	<b>85310</b>	89423
K374-33PLUS	010	<b>83312</b>	89409		...	...	
Modelos con Número de E.O.	02-01890	010	<b>85012</b>	89413		...	...
	02-02061	010	<b>85013</b>	89414		...	...
	02-02142	010	<b>85036</b>	89405		...	...
	02-02225	010	<b>85012</b>	89413		...	...
	03-01635		...	...	010	<b>85308</b>	89422
	03-04629		...	...	-10	<b>85311</b>	89424
	03-05106		...	...	-10	<b>85033</b>	89427
	03-05384		...	...	-10	<b>85033</b>	89427
	03-06084		...	...	-10	<b>85033</b>	89427
	03-07281		...	...	-10	<b>85311</b>	89424
	03-07424		...	...	-10	<b>85311</b>	89424
	03-07424PLUS		...	...	-10	<b>85311</b>	89424
	23-08233		...	...	010	<b>85308</b>	89422
	23-10393		...	...	010	<b>85308</b>	89422
	23-12262	010	<b>85012</b>	89413		...	...
	665133		...	...	010	<b>83203</b>	89436
	665617	010	<b>85031</b>	...		...	...
	665655	010	<b>85062</b>	89408		...	...
	665656	010	<b>85012</b>	89413		...	...
	665657	010	<b>85013</b>	89414		...	...
	665658	010	<b>85036</b>	89405		...	...
	665660		...	...	-10	<b>85033</b>	89427
	665662	010	<b>85012</b>	89413		...	...

**GUÍA DE APLICACIONES – CAMIONES, TRÁILERS Y AUTOBUSES**





Año	Modelo	# E.O.	Delantero		Trasero	
						
						
			Fleetline	GasSLX	Fleetline	GasSLX

**PETERBILT (Cont.)**

**Aplicaciones Adicionales (Cont.)**

	Modelos con Número de E.O.	665738	010	<b>85910</b>	...		...	...
		665752		...	...	010	<b>85067</b>	89451
		665762	010	<b>85012</b>	89413		...	...
		665788		...	...	010	<b>85000</b>	89436
		665826		...	...	-1-	<b>85069</b>	89455
		665858	010	<b>85070</b>	89459		...	...
		665876	010	<b>85959</b>	...		...	...
		665945		...	...	-1-	<b>85902</b>	...
		671091		...	...	-1-	<b>85069</b>	89455
		671092	010	<b>85012</b>	89413		...	...
		671963		...	...	01-	<b>85937</b>	...
		680026		...	...	010	<b>85302</b>	89420
		680027		...	...	010	<b>85308</b>	89422
		680185		...	...	010	<b>85308</b>	89422
		680241		...	...	-10	<b>85311</b>	89424
		680348	010	<b>85012</b>	89413		...	...
		680435		...	...	-10	<b>85033</b>	89427
		680457	010	<b>85302</b>	89420		...	...
		680458		...	...	-1-	<b>85336</b>	...
		680459		...	...	-10	<b>85311</b>	89424
		680586		...	...	-10	<b>85311</b>	89424
		B71-1000	010	<b>85031</b>	...		...	...
		B71-1001	010	<b>85070</b>	89459		...	...
		B71-1002	010	<b>85001</b>	89410		...	...
		B71-1003	010	<b>83312</b>	89409		...	...
		B71-6002	010	<b>85012</b>	89413		...	...
		B71-6003	010	<b>85029</b>	...		...	...
		B71-6004	010	<b>85084</b>	89460		...	...
		B71-6008	010	<b>83312</b>	89409		...	...
		B71-6012	010	<b>85119</b>	...		...	...
		B71-6013	010	<b>85012</b>	89413		...	...
		C71-1013		...	...	01-	<b>85985</b>	...
		C71-1014		...	...	01-	<b>85936</b>	89456
		C71-1015		...	...	01-	<b>85937</b>	...
		C71-6005		...	...	-1-	<b>85069</b>	89455
		K374-38		...	...	-1-	<b>85996</b>	...
		K374-41		...	...	-1-	<b>85997</b>	...
<b>2013 -</b>	Modelos con Número de E.O.	B71-6010	010	<b>85023 or 89415</b>				
<b>Series 210</b>								
	Modelos con Suspensión de Muelles Traseras Reyco 79KB	16725-01		...	...	010	<b>83221</b>	...
<b>Series 220</b>								
	Modelos con Suspensión de Muelles Traseras Reyco 79KB	16725-01		...	...	010	<b>83221</b>	...
<b>Series 270</b>								
	Modelos con Amortiguador Woodhead (Número Estampado ACHB 966)	ACHB966		...	...	-1-	<b>83136</b>	...
<b>Series 320</b>								
	Modelos 320 con Resortes Split Progressive	02-01787	010	<b>85062</b>	89408		...	...
		02-02737	010	<b>85062</b>	89408		...	...
		B71-6009	010	<b>85062</b>	89408		...	...
<b>Series 330</b>								
	Modelos con Eje Delantero con Desplazamiento Hacia Delante de 12000 lb	02-02738	010	<b>85012</b>	89413		...	...
<b>13 - 14</b>	Modelos con Eje Delantero con Desplazamiento Hacia Delante de 12000 lb	B71-6016	010	<b>85012</b>	89413		...	...
		B71-6016A	010	<b>85012</b>	89413		...	...

**GUÍA DE APLICACIONES – CAMIONES, TRÁILERS Y AUTOBUSES**

Año	Modelo	# E.O.	Delantero		Trasero	
						
			Fleetline	GasSLX	Fleetline	GasSLX

**PETERBILT (Cont.)**

**Series 330 (Cont.)**

03 -	Modelos con Suspensión de Aire Peterbilt Baja	03-08781		...	...	- -	<b>85069</b>	89455
		C71-1011		...	...	- -	<b>85069</b>	89455
		C71-1017		...	...	- -	<b>85069</b>	89455
		C71-1017		...	...	- -	<b>85069</b>	89455
- 02	Modelos con Suspensión de Aire Peterbilt de 40000 lb Baja	03-07423		...	...	- 0	<b>85033</b>	89427
	Modelos con Número de E.O.	02-03020	0 0	<b>85910</b>	...		...	...
		B71-6017	0 0	<b>85910</b>	...		...	...

**Series 335**

04 - 10	Modelos con Eje Delantero con Desplazamiento Hacia Delante de 12000 lb	02-02738	0 0	<b>85012</b>	89413		...	...
		02-02741	0 0	<b>85012</b>	89413		...	...
13 - 14	Modelos con Eje Delantero con Desplazamiento Hacia Delante de 12000 lb	B71-6016	0 0	<b>85012</b>	89413		...	...
		B71-6016A	0 0	<b>85012</b>	89413		...	...
04 - 10	Modelos con Suspensión Air Trac (38000 o 40000 lb)	03-07421		...	...	- 0	<b>85311</b>	89424
04	Modelos con Suspensión de Aire Peterbilt Baja	03-07423		...	...	- 0	<b>85033</b>	89427
05 - 10	Modelos con Suspensión de Aire Peterbilt Baja	03-08781		...	...	- -	<b>85069</b>	89455
		C71-1011		...	...	- -	<b>85069</b>	89455
		C71-1017		...	...	- -	<b>85069</b>	89455
		C71-1017		...	...	- -	<b>85069</b>	89455

**Series 337**

10 - 14	Modelos con Eje Delantero de 10,000 a 12,000 lb	B71-6005	0 0	<b>85084</b>	89460		...	...
10 - 14	Modelos con Eje Delantero de 13,200 a 14,600 lb	B71-6006	0 0	<b>85084</b>	89460		...	...
10 - 12	Modelos con Suspensión de Aire Peterbilt Baja	03-08781		...	...	- -	<b>85069</b>	89455
		C71-1011		...	...	- -	<b>85069</b>	89455
		C71-1017		...	...	- -	<b>85069</b>	89455
13 - 14	Modelos con Suspensión de Aire Peterbilt Baja	C71-1017		...	...	- -	<b>85069</b>	89455
10 -	Modelos con Suspensión de Aire Trasera Reyco 102AR (Estándar)	12887-01		...	...	0 0	<b>85013</b>	89414
		12887-02		...	...	0 0	<b>85013</b>	89414
10 -	Modelos con Suspensión de Muelles Traseras Reyco 79KB	16725-01		...	...	0 0	<b>83221</b>	...
10 -	Modelos con Suspensión Peterbilt Air Trac (38000 o 40000 lb)	03-07421		...	...	- 0	<b>85311</b>	89424

**Series 340**

07 - 10	Modelos con Eje Delantero con Desplazamiento Hacia Delante de 12000 lb	02-02738	0 0	<b>85012</b>	89413		...	...
		02-02741	0 0	<b>85012</b>	89413		...	...
13 - 14	Modelos con Eje Delantero con Desplazamiento Hacia Delante de 12000 lb	B71-6016	0 0	<b>85012</b>	89413		...	...
		B71-6016A	0 0	<b>85012</b>	89413		...	...
07 - 10	Modelos con Suspensión Air Trac (38000 o 40000 lb)	03-07421		...	...	- 0	<b>85311</b>	89424

**Series 348**

12 -	Modelos con Eje Delantero de 10,000 a 12,000 lb	B71-6005	0 0	<b>85084</b>	89460		...	...
12	Modelos con Suspensión Air Trac (38000 o 40000 lb)	03-07421		...	...	- 0	<b>85311</b>	89424

**Series 349**

	Modelos Convencionales 349 con capacidad de 12000 lb	02-00376	0 0	<b>85302</b>	89420		...	...
		02-00495	0 0	<b>85302</b>	89420		...	...
		02-02736	0 0	<b>85302</b>	89420		...	...









**Series 353**

	Modelos Convencionales 353 con capacidad de 12000 lb	02-00376	0 0	<b>85302</b>	89420		...	...
		02-00495	0 0	<b>85302</b>	89420		...	...
		02-02736	0 0	<b>85302</b>	89420		...	...

**Series 357**

	Modelos con Air Track Tandem con Eje de Empuje TRD8000	03-08350		...	...	- 0	<b>85343</b>	...
		C71-6004		...	...	- 0	<b>85343</b>	...
- 11/82	Modelos con Suspensión Air Trac (38000 o 40000 lb)	03-04176		...	...	0 0	<b>85308</b>	89422
11/ 82 -	Modelos con Suspensión Air Trac (38000 o 40000 lb)	03-07421		...	...	- 0	<b>85311</b>	89424

## GUÍA DE APLICACIONES – CAMIONES, TRÁILERS Y AUTOBUSES

Año	Modelo	# E.O.	Delantero		Trasero	
						
						
			Fleetline	GasSLX	Fleetline	GasSLX

### PETERBILT (Cont.)

#### Series 357 (Cont.)

- 03	Modelos con Suspensión de Aire Peterbilt Baja	03-07423		...	...	-10	85033	89427
		665633		...	...	-10	85033	89427
03 -	Modelos con Suspensión de Aire Peterbilt Baja	03-08781		...	...	-1-	85069	89455
		C71-1017		...	...	-1-	85069	89455
	Modelos con Suspensión de Aire Trasera Neway ARD 125/244-8	90044011		...	...	010	85004	...
	Modelos con Suspensión Trasera Chalmers de 40,000 lb	665174		...	...	010	85060	...
		800670		...	...	010	85060	...
	Modelos Convencionales con Suspensión de Muelles y Eje Delantero con Desplazamiento hacia Atrás	02-02738	010	85012	89413		...	...
		02-02741	010	85012	89413		...	...
13 - 14	Modelos Convencionales con Suspensión de Muelles y Eje Delantero con Desplazamiento hacia Atrás	B71-6016	010	85012	89413		...	...
		B71-6016A	010	85012	89413		...	...
	Modelos Convencionales con Suspensión de Muelles y Eje Delantero sin Desplazamiento hacia Atrás	02-02737	010	85062	89408		...	...
		02-02742	010	85062	89408		...	...
		B71-6007	010	85062	89408		...	...
		B71-6009	010	85062	89408		...	...
		B71-6011	010	85062	89408		...	...
	Modelos Convencionales con Suspensión Delantera de Aire y Eje Delantero con Desplazamiento hacia Atrás	02-02739	010	85013	89414		...	...
	Modelos Convencionales con Suspensión Delantera de Aire y sin Eje Delantero con Desplazamiento hacia Atrás	02-02740	010	85036	89405		...	...

#### Series 359

	Modelos Convencionales 359 con capacidad de 12000 lb	02-00376	010	85302	89420		...	...
		02-00495	010	85302	89420		...	...
		02-02736	010	85302	89420		...	...





#### Series 362

	Modelos C.O.E. con capacidad de 12000 lb	02-02736	010	85302	89420		...	...
	Modelos C.O.E. con Muelles 14600 lb y Eje Delantero con Desplazamiento hacia Atrás	02-02740	010	85036	89405		...	...
	Modelos C.O.E. con Resortes Progresivos	02-02738	010	85012	89413		...	...
13 - 14	Modelos C.O.E. con Resortes Progresivos	B71-6016	010	85012	89413		...	...
		B71-6016A	010	85012	89413		...	...
	Modelos C.O.E. sin Eje Delantero con Desplazamiento hacia Atrás	02-00376	010	85302	89420		...	...
		02-00495	010	85302	89420		...	...
- 11/82	Modelos con Suspensión Air Trac (38000 o 40000 lb)	03-04176		...	...	010	85308	89422
11/ 82 -	Modelos con Suspensión Air Trac (38000 o 40000 lb)	03-07421		...	...	-10	85311	89424
- 03	Modelos con Suspensión de Aire Peterbilt Baja	03-07423		...	...	-10	85033	89427
		665633		...	...	-10	85033	89427
03 -	Modelos con Suspensión de Aire Peterbilt Baja	03-08781		...	...	-1-	85069	89455
		C71-1017		...	...	-1-	85069	89455
	Modelos con Suspensión de Aire Trasera Neway ARD 125/244-8	90044011		...	...	010	85004	...
	Modelos con Suspensión Trasera Chalmers de 40,000 lb	665174		...	...	010	85060	...
		800670		...	...	010	85060	...

#### Series 365

08 - 13	Modelos con Suspensión Air Trac (38000 o 40000 lb)	03-07421		...	...	-10	85311	89424
08 -	Modelos con Suspensión de Aire Peterbilt Baja	03-08781		...	...	-1-	85069	89455
		C71-1011		...	...	-1-	85069	89455
		C71-1017		...	...	-1-	85069	89455
		C71-1017		...	...	-1-	85069	89455
08 - 12	Modelos con Suspensión Delantera de Muelles de 12000 lb a 16000 lb	B71-6002	010	85012	89413		...	...
08 - 12	Modelos con Suspensión Delantera de Muelles Taperleaf de 18,000 lb a 23,000 lb	02-02742	010	85062	89408		...	...

**GUÍA DE APLICACIONES – CAMIONES, TRÁILERS Y AUTOBUSES**

Año	Modelo	# E.O.	Delantero		Trasero	
						
			Fleetline	GasSLX	Fleetline	GasSLX

**PETERBILT (Cont.)**

**Series 365 (Cont.)**

08 - 12	Modelos con Suspensión Delantera de Muelles Taperleaf de 18,000 lb a 23,000 lb	B71-6007	oio	85062	89408		...	...
		B71-6011	oio	85062	89408		...	...
08 - 12	Modelos con Suspensión FlexAir (38000 lb)	C71-1002		...	...	oio	85067	89451
		C71-1016		...	...	oio	85067	89451
		C71-6000		...	...	oio	85067	89451
08 - 12	Modelos con Suspensión Hendrickson HMX 400/460 Haulmax con Silla de Montaje de 16.5"	60680-004		...	...	o1-	83143	...
08 - 12	Modelos con Suspensión Hendrickson HMX 400/460 Haulmax con Silla de Montaje de 17.5" & 18.5"	60680-005		...	...	o1-	83142	...
08 - 12	Modelos con Suspensión Trasera de 4 Muelles Quadraflex	03-07420		...	...	-1-	85336	...

**Series 367**

08 - 10	Modelos con Suspensión Air Trac (38000 o 40000 lb)	03-07421		...	...	-1o	85311	89424
	Modelos con Suspensión Air Track Tri Drive	03-08350		...	...	-1o	85343	...
08 -	Modelos con Suspensión de Aire Peterbilt Baja	C71-6004		...	...	-1o	85343	...
		03-08781		...	...	-1-	85069	89455
		C71-1011		...	...	-1-	85069	89455
08 - 10	Modelos con Suspensión de Muelles Delanteras de 10,000 lb a 16,000 lb	C71-1017		...	...	-1-	85069	89455
		C71-1017		...	...	-1-	85069	89455
		B71-6002	oio	85012	89413		...	...
08 - 10	Modelos con Suspensión Delantera de Muelles Taperleaf de 18,000 lb a 23,000 lb	02-02742	oio	85062	89408		...	...
		B71-6007	oio	85062	89408		...	...
		B71-6011	oio	85062	89408		...	...
08 - 10	Modelos con Suspensión FlexAir (38000 lb)	C71-1002		...	...	oio	85067	89451
		C71-1016		...	...	oio	85067	89451
		C71-6000		...	...	oio	85067	89451
08 - 13	Modelos con Suspensión Hendrickson HMX 400/460 Haulmax con Silla de Montaje de 16.5"	60680-004		...	...	o1-	83143	...
08 - 13	Modelos con Suspensión Hendrickson HMX 400/460 Haulmax con Silla de Montaje de 17.5" & 18.5"	60680-005		...	...	o1-	83142	...
08 - 10	Modelos con Suspensión Trasera Chalmers de 40,000 lb	665174		...	...	oio	85060	...
		800670		...	...	oio	85060	...
08 - 10	Modelos con Suspensión Trasera de 4 Muelles Quadraflex	03-07420		...	...	-1-	85336	...





**Series 372**

	Modelos C.O.E. con Suspensión de Aire Delantero	02-02739	oio	85013	89414		...	...
	Modelos C.O.E. con Suspensión de Muelles	02-02738	oio	85012	89413		...	...
13 - 14	Modelos C.O.E. con Suspensión de Muelles	B71-6016	oio	85012	89413		...	...
		B71-6016A	oio	85012	89413		...	...
- 11/82	Modelos con Suspensión Air Trac (38000 o 40000 lb)	03-04176		...	...	oio	85308	89422
11/ 82 -	Modelos con Suspensión Air Trac (38000 o 40000 lb)	03-07421		...	...	-1o	85311	89424
- 03	Modelos con Suspensión de Aire Peterbilt Baja	03-07423		...	...	-1o	85033	89427
		665633		...	...	-1o	85033	89427
03 -	Modelos con Suspensión de Aire Peterbilt Baja	03-08781		...	...	-1-	85069	89455
		C71-1017		...	...	-1-	85069	89455
	Modelos con Suspensión de Aire Trasera Neway ARD 125/244-8	90044011		...	...	oio	85004	...
03 -	Modelos con Suspensión Trasera Chalmers de 40,000 lb	665174		...	...	oio	85060	...
		800670		...	...	oio	85060	...

**Series 375**

- 11/82	Modelos con Suspensión Air Trac (38000 o 40000 lb)	03-04176		...	...	oio	85308	89422
11/ 82 -	Modelos con Suspensión Air Trac (38000 o 40000 lb)	03-07421		...	...	-1o	85311	89424
- 03	Modelos con Suspensión de Aire Peterbilt Baja	03-07423		...	...	-1o	85033	89427
		665633		...	...	-1o	85033	89427
03 -	Modelos con Suspensión de Aire Peterbilt Baja	03-08781		...	...	-1-	85069	89455
		C71-1017		...	...	-1-	85069	89455

**GUÍA DE APLICACIONES – CAMIONES, TRÁILERS Y AUTOBUSES**

Año	Modelo	# E.O.	Delantero		Trasero	
						
			Fleetline	GasSLX	Fleetline	GasSLX

**PETERBILT (Cont.)**

**Series 375 (Cont.)**

	Modelos con Suspensión de Aire Trasera Neway ARD 125/244-8	90044011		...	...	010	<b>85004</b>	...
	Modelos con Suspensión Trasera Chalmers de 40,000 lb	665174		...	...	010	<b>85060</b>	...
		800670		...	...	010	<b>85060</b>	...
	Modelos Convencionales con Suspensión de Muelles y Eje Delantero con Desplazamiento hacia Atrás	02-02738	010	<b>85012</b>	<b>89413</b>		...	...
		02-02741	010	<b>85012</b>	<b>89413</b>		...	...
<b>13 - 14</b>	Modelos Convencionales con Suspensión de Muelles y Eje Delantero con Desplazamiento hacia Atrás	B71-6016	010	<b>85012</b>	<b>89413</b>		...	...
		B71-6016A	010	<b>85012</b>	<b>89413</b>		...	...
	Modelos Convencionales con Suspensión de Muelles y Eje Delantero sin Desplazamiento hacia Atrás	02-02737	010	<b>85062</b>	<b>89408</b>		...	...
		02-02742	010	<b>85062</b>	<b>89408</b>		...	...
		B71-6007	010	<b>85062</b>	<b>89408</b>		...	...
		B71-6009	010	<b>85062</b>	<b>89408</b>		...	...
		B71-6011	010	<b>85062</b>	<b>89408</b>		...	...
	Modelos Convencionales con Suspensión Delantero de Aire y Eje Delantero con Desplazamiento hacia Atrás	02-02739	010	<b>85013</b>	<b>89414</b>		...	...
	Modelos Convencionales con Suspensión Delantero de Aire y sin Eje Delantero con Desplazamiento hacia Atrás	02-02740	010	<b>85036</b>	<b>89405</b>		...	...



**Series 376**

<b>- 11/82</b>	Modelos con Suspensión Air Trac (38000 o 40000 lb)	03-04176		...	...	010	<b>85308</b>	<b>89422</b>
<b>11/ 82 -</b>	Modelos con Suspensión Air Trac (38000 o 40000 lb)	03-07421		...	...	-10	<b>85311</b>	<b>89424</b>
<b>- 03</b>	Modelos con Suspensión de Aire Peterbilt Baja	03-07423		...	...	-10	<b>85033</b>	<b>89427</b>
		665633		...	...	-10	<b>85033</b>	<b>89427</b>
<b>03 -</b>	Modelos con Suspensión de Aire Peterbilt Baja	03-08781		...	...	-1-	<b>85069</b>	<b>89455</b>
		C71-1017		...	...	-1-	<b>85069</b>	<b>89455</b>
	Modelos con Suspensión de Aire Trasera Neway ARD 125/244-8	90044011		...	...	010	<b>85004</b>	...
	Modelos con Suspensión Trasera Chalmers de 40,000 lb	665174		...	...	010	<b>85060</b>	...
		800670		...	...	010	<b>85060</b>	...
	Modelos Convencionales con Suspensión de Muelles y Eje Delantero con Desplazamiento hacia Atrás	02-02738	010	<b>85012</b>	<b>89413</b>		...	...
		02-02741	010	<b>85012</b>	<b>89413</b>		...	...
<b>13 - 14</b>	Modelos Convencionales con Suspensión de Muelles y Eje Delantero con Desplazamiento hacia Atrás	B71-6016	010	<b>85012</b>	<b>89413</b>		...	...
		B71-6016A	010	<b>85012</b>	<b>89413</b>		...	...
	Modelos Convencionales con Suspensión de Muelles y Eje Delantero sin Desplazamiento hacia Atrás	02-02737	010	<b>85062</b>	<b>89408</b>		...	...
		02-02742	010	<b>85062</b>	<b>89408</b>		...	...
		B71-6007	010	<b>85062</b>	<b>89408</b>		...	...
		B71-6009	010	<b>85062</b>	<b>89408</b>		...	...
		B71-6011	010	<b>85062</b>	<b>89408</b>		...	...
	Modelos Convencionales con Suspensión Delantero de Aire y Eje Delantero con Desplazamiento hacia Atrás	02-02739	010	<b>85013</b>	<b>89414</b>		...	...
	Modelos Convencionales con Suspensión Delantero de Aire y sin Eje Delantero con Desplazamiento hacia Atrás	02-02740	010	<b>85036</b>	<b>89405</b>		...	...

**Series 377**

<b>- 11/82</b>	Modelos con Suspensión Air Trac (38000 o 40000 lb)	03-04176		...	...	010	<b>85308</b>	<b>89422</b>
<b>11/ 82 -</b>	Modelos con Suspensión Air Trac (38000 o 40000 lb)	03-07421		...	...	-10	<b>85311</b>	<b>89424</b>
<b>- 03</b>	Modelos con Suspensión de Aire Peterbilt Baja	03-07423		...	...	-10	<b>85033</b>	<b>89427</b>
		665633		...	...	-10	<b>85033</b>	<b>89427</b>
	Modelos con Suspensión de Aire Trasera Neway ARD 125/244-8	90044011		...	...	010	<b>85004</b>	...
	Modelos con Suspensión Trasera Chalmers de 40,000 lb	665174		...	...	010	<b>85060</b>	...
		800670		...	...	010	<b>85060</b>	...
	Modelos Convencionales con Suspensión de Muelles y Eje Delantero con Desplazamiento hacia Atrás	02-02738	010	<b>85012</b>	<b>89413</b>		...	...
		02-02741	010	<b>85012</b>	<b>89413</b>		...	...

**GUÍA DE APLICACIONES – CAMIONES, TRÁILERS Y AUTOBUSES**

Año	Modelo	# E.O.	Delantero		Trasero	
						
			Fleetline	GasSLX	Fleetline	GasSLX

**PETERBILT (Cont.)**

**Series 377 (Cont.)**

Modelos Convencionales con Suspensión de Muelles y Eje Delantero sin Desplazamiento hacia Atrás	02-02737	010	<b>85062</b>	89408		...	...
	02-02742	010	<b>85062</b>	89408		...	...
	B71-6007	010	<b>85062</b>	89408		...	...
	B71-6009	010	<b>85062</b>	89408		...	...
	B71-6011	010	<b>85062</b>	89408		...	...
Modelos Convencionales con Suspensión Delantero de Aire y Eje Delantero con Desplazamiento hacia Atrás	02-02739	010	<b>85013</b>	89414		...	...
Modelos Convencionales con Suspensión Delantero de Aire y sin Eje Delantero con Desplazamiento hacia Atrás	02-02740	010	<b>85036</b>	89405		...	...

**Series 378**









- 11/82	Modelos con Suspensión Air Trac (38000 o 40000 lb)	03-04176		...	...	010	<b>85308</b>	89422
11/ 82 -	Modelos con Suspensión Air Trac (38000 o 40000 lb)	03-07421		...	...	-10	<b>85311</b>	89424
- 03	Modelos con Suspensión de Aire Peterbilt Baja	03-07423		...	...	-10	<b>85033</b>	89427
		665633		...	...	-10	<b>85033</b>	89427
03 -	Modelos con Suspensión de Aire Peterbilt Baja	03-08781		...	...	-1-	<b>85069</b>	89455
		C71-1017		...	...	-1-	<b>85069</b>	89455
	Modelos con Suspensión de Aire Trasera Neway ARD 125/244-8	90044011		...	...	010	<b>85004</b>	...
01 -	Modelos con Suspensión FlexAir (38000 lb)	C71-6000		...	...	010	<b>85067</b>	89451
	Modelos con Suspensión Trasera Chalmers de 40,000 lb	665174		...	...	010	<b>85060</b>	...
		800670		...	...	010	<b>85060</b>	...
	Modelos Convencionales con Suspensión de Muelles y Eje Delantero con Desplazamiento hacia Atrás	02-02738	010	<b>85012</b>	89413		...	...
		02-02741	010	<b>85012</b>	89413		...	...
13 - 14	Modelos Convencionales con Suspensión de Muelles y Eje Delantero con Desplazamiento hacia Atrás	B71-6016	010	<b>85012</b>	89413		...	...
	Modelos Convencionales con Suspensión de Muelles y Eje Delantero sin Desplazamiento hacia Atrás	B71-6016A	010	<b>85012</b>	89413		...	...
		02-02737	010	<b>85062</b>	89408		...	...
		02-02742	010	<b>85062</b>	89408		...	...
		B71-6007	010	<b>85062</b>	89408		...	...
		B71-6009	010	<b>85062</b>	89408		...	...
	Modelos Convencionales con Suspensión Delantero de Aire y Eje Delantero con Desplazamiento hacia Atrás	02-02739	010	<b>85013</b>	89414		...	...
	Modelos Convencionales con Suspensión Delantero de Aire y sin Eje Delantero con Desplazamiento hacia Atrás	02-02740	010	<b>85036</b>	89405		...	...

**Series 379**

- 11/82	Modelos con Suspensión Air Trac (38000 o 40000 lb)	03-04176		...	...	010	<b>85308</b>	89422
11/ 82 -	Modelos con Suspensión Air Trac (38000 o 40000 lb)	03-07421		...	...	-10	<b>85311</b>	89424
- 03	Modelos con Suspensión de Aire Peterbilt Baja	03-07423		...	...	-10	<b>85033</b>	89427
		665633		...	...	-10	<b>85033</b>	89427
03 -	Modelos con Suspensión de Aire Peterbilt Baja	03-08781		...	...	-1-	<b>85069</b>	89455
		C71-1017		...	...	-1-	<b>85069</b>	89455
	Modelos con Suspensión de Aire Trasera Neway ARD 125/244-8	90044011		...	...	010	<b>85004</b>	...
01 -	Modelos con Suspensión FlexAir (38000 lb)	C71-6000		...	...	010	<b>85067</b>	89451
	Modelos con Suspensión Trasera Chalmers de 40,000 lb	665174		...	...	010	<b>85060</b>	...
		800670		...	...	010	<b>85060</b>	...
	Modelos Convencionales con Suspensión de Muelles y Eje Delantero con Desplazamiento hacia Atrás	02-02738	010	<b>85012</b>	89413		...	...
		02-02741	010	<b>85012</b>	89413		...	...
13 - 14	Modelos Convencionales con Suspensión de Muelles y Eje Delantero con Desplazamiento hacia Atrás	B71-6016	010	<b>85012</b>	89413		...	...
	Modelos Convencionales con Suspensión de Muelles y Eje Delantero sin Desplazamiento hacia Atrás	B71-6016A	010	<b>85012</b>	89413		...	...
		02-02737	010	<b>85062</b>	89408		...	...
		02-02742	010	<b>85062</b>	89408		...	...



## GUÍA DE APLICACIONES – CAMIONES, TRÁILERS Y AUTOBUSES

Año	Modelo	# E.O.	Delantero		Trasero	
						
						
			Fleetline	GasSLX	Fleetline	GasSLX

### PETERBILT (Cont.)

#### Series 379 (Cont.)

	Modelos Convencionales con Suspensión de Muelles y Eje Delantero sin Desplazamiento hacia Atrás	B71-6007	010	85062	89408		...	...
		B71-6009	010	85062	89408		...	...
		B71-6011	010	85062	89408		...	...
	Modelos Convencionales con Suspensión Delantero de Aire y Eje Delantero con Desplazamiento hacia Atrás	02-02739	010	85013	89414		...	...
	Modelos Convencionales con Suspensión Delantero de Aire y sin Eje Delantero con Desplazamiento hacia Atrás	02-02740	010	85036	89405		...	...

#### Series 382

11 -	Modelos con Eje Delantero de 10,000 a 12,000 lb	B71-6005	010	85084	89460		...	...
10 -	Modelos con Suspensión Air Trac (38000 o 40000 lb)	03-07421		...	...	-10	85311	89424
10 -	Modelos con Suspensión de Aire Peterbilt Baja	03-08781		...	...	-1-	85069	89455
		C71-1011		...	...	-1-	85069	89455
		C71-1017		...	...	-1-	85069	89455
		C71-1017		...	...	-1-	85069	89455
10 -	Modelos con Suspensión de Aire Trasera Reyco 102AR (Estándar)	12887-01		...	...	010	85013	89414
		12887-02		...	...	010	85013	89414
10 -	Modelos con Suspensión de Muelles Taperleaf de 12,000 lb a 14,600 lb	02-02737	010	85062	89408		...	...
		B71-6009	010	85062	89408		...	...
10 -	Modelos con Suspensión de Muelles Traseras Reyco 79KB	16725-01		...	...	010	83221	...
10 -	Modelos con Suspensión FlexAir (38000 lb)	C71-1002		...	...	010	85067	89451
		C71-1016		...	...	010	85067	89451
		C71-6000		...	...	010	85067	89451
10 -	Modelos con Suspensión Trasera de 4 Muelles Quadraflex	03-07420		...	...	-1-	85336	...





#### Series 384

10 - 12	Modelos con Suspensión Air Trac (38000 o 40000 lb)	03-07421		...	...	-10	85311	89424
10 -	Modelos con Suspensión de Aire Peterbilt Baja	03-08781		...	...	-1-	85069	89455
		C71-1011		...	...	-1-	85069	89455
		C71-1017		...	...	-1-	85069	89455
		C71-1017		...	...	-1-	85069	89455
13 - 14	Modelos con Suspensión de Muelles Taperleaf (Estándar Duty) de 12,000 lb a 14,600 lb	B71-6009	010	83219	89408		...	...
13 - 14	Modelos con Suspensión de Muelles Taperleaf (Heavy Duty) de 12,000 lb a 14,600 lb	B71-6009	010	85062	89408		...	...
10 - 12	Modelos con Suspensión de Muelles Taperleaf de 12,000 lb a 14,600 lb y Eje Delantero con Desplazamiento hacia Adelante	02-02737	010	85062	89408		...	...
		B71-6009	010	85062	89408		...	...
10 -	Modelos con Suspensión FlexAir (38000 lb)	C71-1002		...	...	010	85067	89451
		C71-1016		...	...	010	85067	89451
		C71-6000		...	...	010	85067	89451
10 -	Modelos con Suspensión Trasera de 4 Muelles Quadraflex	03-07420		...	...	-1-	85336	...

#### Series 385

- 11/82	Modelos con Suspensión Air Trac	03-04176		...	...	010	85308	89422
11/ 82 -	Modelos con Suspensión Air Trac	03-07421		...	...	-10	85311	89424
- 03	Modelos con Suspensión de Aire Peterbilt Baja	03-07423		...	...	-10	85033	89427
		665633		...	...	-10	85033	89427
03 -	Modelos con Suspensión de Aire Peterbilt Baja	03-08781		...	...	-1-	85069	89455
		C71-1017		...	...	-1-	85069	89455
	Modelos con Suspensión de Aire Trasera Neway ARD 125/244-8	90044011		...	...	010	85004	...
01 -	Modelos con Suspensión FlexAir (38000 lb)	C71-6000		...	...	010	85067	89451
	Modelos con Suspensión Trasera Chalmers de 40,000 lb	665174		...	...	010	85060	...
		800670		...	...	010	85060	...
	Modelos con Suspensión Trasera de 4 Muelles Quadraflex	03-07420		...	...	-1-	85336	...
- 09	Modelos Convencionales con Suspensión de Muelles y Eje Delantero con Desplazamiento hacia Atrás	02-02738	010	85012	89413		...	...

**GUÍA DE APLICACIONES – CAMIONES, TRÁILERS Y AUTOBUSES**

Año	Modelo	# E.O.	Delantero		Trasero	
						
			Fleetline	GasSLX	Fleetline	GasSLX

**PETERBILT (Cont.)**

**Series 385 (Cont.)**

- 09	Modelos Convencionales con Suspensión de Muelles y Eje Delantero con Desplazamiento hacia Atrás	02-02741	010	<b>85012</b>	89413		...	...
13 - 14	Modelos Convencionales con Suspensión de Muelles y Eje Delantero con Desplazamiento hacia Atrás	B71-6016	010	<b>85012</b>	89413		...	...
		B71-6016A	010	<b>85012</b>	89413		...	...
- 09	Modelos Convencionales con Suspensión de Muelles y Eje Delantero sin Desplazamiento hacia Atrás	02-02737	010	<b>85062</b>	89408		...	...
		02-02742	010	<b>85062</b>	89408		...	...
		B71-6007	010	<b>85062</b>	89408		...	...
		B71-6009	010	<b>85062</b>	89408		...	...
		B71-6011	010	<b>85062</b>	89408		...	...





**Series 386**

06 -	Modelos con Suspensión de Aire Peterbilt	03-07421		...	...	-10	<b>85311</b>	89424
06 -	Modelos con Suspensión de Aire Peterbilt Baja	03-08781		...	...	-1-	<b>85069</b>	89455
		C71-1011		...	...	-1-	<b>85069</b>	89455
		C71-1017		...	...	-1-	<b>85069</b>	89455
		C71-1017		...	...	-1-	<b>85069</b>	89455
06 -	Modelos con Suspensión FlexAir (38000 lb)	C71-6000		...	...	010	<b>85067</b>	89451
08 - 12	Modelos con Suspensión FlexAir (38000 lb)	C71-1002		...	...	010	<b>85067</b>	89451
		C71-1016		...	...	010	<b>85067</b>	89451
06 -	Modelos Convencionales con Suspensión de Muelles y Eje Delantero con Desplazamiento hacia Atrás	02-02738	010	<b>85012</b>	89413		...	...
		02-02741	010	<b>85012</b>	89413		...	...
		02-04010	010	<b>85012</b>	89413		...	...
		B71-6018	010	<b>85012</b>	89413		...	...
13 - 14	Modelos Convencionales con Suspensión de Muelles y Eje Delantero con Desplazamiento hacia Atrás	B71-6016	010	<b>85012</b>	89413		...	...
		B71-6016A	010	<b>85012</b>	89413		...	...
06 -	Modelos Convencionales con Suspensión de Muelles y Eje Delantero sin Desplazamiento hacia Atrás	02-02742	010	<b>85062</b>	89408		...	...
		B71-6007	010	<b>85062</b>	89408		...	...
		B71-6011	010	<b>85062</b>	89408		...	...
06 - 12	Modelos Convencionales con Suspensión de Muelles y Eje Delantero sin Desplazamiento hacia Atrás	02-02737	010	<b>85062</b>	89408		...	...
		B71-6009	010	<b>85062</b>	89408		...	...
06 -	Modelos Convencionales con Suspensión Delantero de Aire y Eje Delantero con Desplazamiento hacia Atrás	02-02739	010	<b>85013</b>	89414		...	...
06 -	Modelos Convencionales con Suspensión Delantero de Aire y sin Eje Delantero con Desplazamiento hacia Atrás	02-02740	010	<b>85036</b>	89405		...	...

**Series 387**

- 09	Modelos con Suspensión de Aire Peterbilt	03-07421		...	...	-10	<b>85311</b>	89424
- 03	Modelos con Suspensión de Aire Peterbilt Baja	03-07423		...	...	-10	<b>85033</b>	89427
		665633		...	...	-10	<b>85033</b>	89427
03 -	Modelos con Suspensión de Aire Peterbilt Baja	03-08781		...	...	-1-	<b>85069</b>	89455
		C71-1011		...	...	-1-	<b>85069</b>	89455
		C71-1017		...	...	-1-	<b>85069</b>	89455
		C71-1017		...	...	-1-	<b>85069</b>	89455
01 -	Modelos con Suspensión FlexAir (38000 lb)	C71-6000		...	...	010	<b>85067</b>	89451
- 09	Modelos Convencionales con Suspensión de Muelles y Eje Delantero con Desplazamiento hacia Atrás	02-02738	010	<b>85012</b>	89413		...	...
		02-02741	010	<b>85012</b>	89413		...	...
		02-04010	010	<b>85012</b>	89413		...	...
		B71-6018	010	<b>85012</b>	89413		...	...
13 - 14	Modelos Convencionales con Suspensión de Muelles y Eje Delantero con Desplazamiento hacia Atrás	B71-6016	010	<b>85012</b>	89413		...	...
		B71-6016A	010	<b>85012</b>	89413		...	...
- 09	Modelos Convencionales con Suspensión de Muelles y Eje Delantero sin Desplazamiento hacia Atrás	02-02737	010	<b>85062</b>	89408		...	...
		02-02742	010	<b>85062</b>	89408		...	...

## GUÍA DE APLICACIONES – CAMIONES, TRÁILERS Y AUTOBUSES

Año	Modelo	# E.O.	Delantero		Trasero	
			 Fleetline	 GasSLX	 Fleetline	 GasSLX

### PETERBILT (Cont.)

#### Series 387 (Cont.)

- 09	Modelos Convencionales con Suspensión de Muelles y Eje Delantero sin Desplazamiento hacia Atrás	B71-6007	010	<b>85062</b>	89408	...	...
		B71-6009	010	<b>85062</b>	89408	...	...
		B71-6011	010	<b>85062</b>	89408	...	...
- 09	Modelos Convencionales con Suspensión Delantero de Aire y Eje Delantero con Desplazamiento hacia Atrás	02-02739	010	<b>85013</b>	89414	...	...
- 09	Modelos Convencionales con Suspensión Delantero de Aire y sin Eje Delantero con Desplazamiento hacia Atrás	02-02740	010	<b>85036</b>	89405	...	...

#### Series 388

14 -	Modelos con Número de E.O.	C71-6003		...	...	-10	<b>85988</b>	...
08 - 14	Modelos con Suspensión de Aire Peterbilt	03-07421		...	...	-10	<b>85311</b>	89424
		03-07421PLUS		...	...	-10	<b>85311</b>	89424
		C71-6002		...	...	-10	<b>85311</b>	89424
08 - 12	Modelos con Suspensión de Aire Peterbilt Baja	03-08781		...	...	-1-	<b>85069</b>	89455
		C71-1011		...	...	-1-	<b>85069</b>	89455
		C71-1017		...	...	-1-	<b>85069</b>	89455
13 - 14	Modelos con Suspensión de Aire Peterbilt Baja	C71-1017		...	...	-1-	<b>85069</b>	89455
13 - 14	Modelos con Suspensión de Muelles Taperleaf (Estándar Duty) de 12,000 lb a 14,600 lb	B71-6009	010	<b>83219</b>	89408		...	...
13 - 14	Modelos con Suspensión de Muelles Taperleaf (Heavy Duty) de 12,000 lb a 14,600 lb	B71-6009	010	<b>85062</b>	89408		...	...
08 -	Modelos con Suspensión FlexAir (38000 lb)	C71-6000		...	...	010	<b>85067</b>	89451
08 -	Modelos Convencionales con Suspensión de Muelles y Eje Delantero con Desplazamiento hacia Atrás	02-04010	010	<b>85012</b>	89413		...	...
		B71-6018	010	<b>85012</b>	89413		...	...
08 - 12	Modelos Convencionales con Suspensión de Muelles y Eje Delantero sin Desplazamiento hacia Atrás	02-02742	010	<b>85062</b>	89408		...	...
		B71-6007	010	<b>85062</b>	89408		...	...
		B71-6011	010	<b>85062</b>	89408		...	...
08 -	Modelos Convencionales con Suspensión Delantero de Aire y Eje Delantero con Desplazamiento hacia Atrás	02-02739	010	<b>85013</b>	89414		...	...
08 -	Modelos Convencionales con Suspensión Delantero de Aire y sin Eje Delantero con Desplazamiento hacia Atrás	02-02740	010	<b>85036</b>	89405		...	...





#### Series 389

08 -	Modelos con Suspensión de Aire Peterbilt	03-07421		...	...	-10	<b>85311</b>	89424
		C71-6002		...	...	-10	<b>85311</b>	89424
08 -	Modelos con Suspensión de Aire Peterbilt Baja	03-08781		...	...	-1-	<b>85069</b>	89455
		C71-1011		...	...	-1-	<b>85069</b>	89455
		C71-1017		...	...	-1-	<b>85069</b>	89455
		C71-1017		...	...	-1-	<b>85069</b>	89455
10 - 12	Modelos con Suspensión de Muelles Taperleaf de 12,000 lb a 14,600 lb	02-02737	010	<b>85062</b>	89408		...	...
		B71-6009	010	<b>85062</b>	89408		...	...
08 -	Modelos con Suspensión FlexAir (38000 lb)	C71-6000		...	...	010	<b>85067</b>	89451
08 -	Modelos Convencionales con Suspensión de Muelles y Eje Delantero con Desplazamiento hacia Atrás	02-04010	010	<b>85012</b>	89413		...	...
		B71-6018	010	<b>85012</b>	89413		...	...
08 -	Modelos Convencionales con Suspensión de Muelles y Eje Delantero sin Desplazamiento hacia Atrás	02-02742	010	<b>85062</b>	89408		...	...
		B71-6007	010	<b>85062</b>	89408		...	...
		B71-6011	010	<b>85062</b>	89408		...	...
08 -	Modelos Convencionales con Suspensión Delantero de Aire y Eje Delantero con Desplazamiento hacia Atrás	02-02739	010	<b>85013</b>	89414		...	...
08 -	Modelos Convencionales con Suspensión Delantero de Aire y sin Eje Delantero con Desplazamiento hacia Atrás	02-02740	010	<b>85036</b>	89405		...	...

#### Series 579

14 - 15	Modelos con Eje Delantero de 10,000 a 13,200 lb	B71-6019	010	<b>85989</b>	...		...	...
12	Modelos con Suspensión Air Trac (38000 o 40000 lb)	03-07421		...	...	-10	<b>85311</b>	89424
		C71-6002		...	...	-10	<b>85311</b>	89424

**GUÍA DE APLICACIONES – CAMIONES, TRÁILERS Y AUTOBUSES**

Año	Modelo	# E.O.	Delantero		Trasero	
						
			Fleetline	GasSLX	Fleetline	GasSLX

**PETERBILT (Cont.)**

**Series 579 (Cont.)**

12	Modelos con Suspensión de Aire Delantera Peterbilt	B71-6000	010	85920	...	...	...	...
12 -	Modelos con Suspensión de Aire Peterbilt Baja	03-08781		...	...	- -	85069	89455
		C71-1011		...	...	- -	85069	89455
		C71-1017		...	...	- -	85069	89455
		C71-1017		...	...	- -	85069	89455
12	Modelos con Suspensión de Aire Trasera Reyco 102AR (Estándar)	12887-01		...	...	010	85013	89414
		12887-02		...	...	010	85013	89414
12	Modelos con Suspensión de Muelles Taperleaf de 12,000 lb a 14,600 lb	02-02737	010	85062	89408		...	...
		B71-6009	010	85062	89408		...	...
12	Modelos con Suspensión de Muelles Traseras Reyco 79KB	16725-01		...	...	010	83221	...
12	Modelos con Suspensión FlexAir (38000 lb)	C71-1002		...	...	010	85067	89451
		C71-1016		...	...	010	85067	89451
		C71-6000		...	...	010	85067	89451

**Series 587**

10 -	Modelos con Suspensión Air Trac (38000 o 40000 lb)	03-07421		...	...	- 0	85311	89424
		C71-6002		...	...	- 0	85311	89424
12	Modelos con Suspensión de Aire Delantera Peterbilt	B71-6000	010	85920	...	...	...	...
10 -	Modelos con Suspensión de Aire Peterbilt Baja	03-08781		...	...	- -	85069	89455
		C71-1011		...	...	- -	85069	89455
		C71-1017		...	...	- -	85069	89455
		C71-1017		...	...	- -	85069	89455
10 -	Modelos con Suspensión de Aire Trasera Reyco 102AR (Estándar)	12887-01		...	...	010	85013	89414
		12887-02		...	...	010	85013	89414
10 -	Modelos con Suspensión de Muelles Taperleaf de 12,000 lb a 14,600 lb	02-02737	010	85062	89408		...	...
		B71-6009	010	85062	89408		...	...
10 -	Modelos con Suspensión de Muelles Traseras Reyco 79KB	16725-01		...	...	010	83221	...
10 -	Modelos con Suspensión FlexAir (38000 lb)	C71-1002		...	...	010	85067	89451
		C71-1016		...	...	010	85067	89451
		C71-6000		...	...	010	85067	89451
10 -	Modelos con Suspensión Trasera de 4 Muelles Quadraflex	03-07420		...	...	- -	85336	...

**PETERBILT AMORTIGUADORES DE CABINA**

81 -	Cabina Abatible 362 con Modelo Link Cabmate PB-362-2P	1202-0032	010				83016	
	Camiones y Tractos Convencionales 357, 375, 376, 377 & 378 con Modelos Link Cabmate PBC377 & PBC377-A	1202-0054	010				83021	
	Camiones y Tractos Convencionales 359 & 379 con Modelos Link Cabmate PBC379 & PBC379-A	1202-0054	010				83021	
13 - 14	Day Cab Convencional 388 con Número de E.O.	R71-6005	010				83042	
78 -	Dormitorio de 63" con Modelo Link Bunkmate PBS63-A	1202-1044	010				83025	
78 -	Dormitorios de 48" con Modelo Link Bunkmate PBS48-A	1202-1044	010				83025	
99 -	Modelos 387 con Dormitorio de 70"	29-06032	010				83035	
		R71-6008	010				83035	
99 -	Modelos 387 con Número de E.O.	29-06005	010				83035	
08 -	Modelos 389 con Dormitorio de 70"	29-02455	010				83008	
		R71-6007	010				83008	
	Modelos con Número de E.O.	654782	010				83008	
		654812	010				83042	
		654919	010				83035	
		R71-1004	010				83049	
		R71-1005	010				83024	
	Modelos con Suspensión de Cabina PowerPacker	96027-1054	010				83011	
		PP1058870	010				83059	
		PP1059870	010				83060	

## GUÍA DE APLICACIONES – CAMIONES, TRÁILERS Y AUTOBUSES

Año	Modelo	# E.O.	Delantero		Trasero	
			Fleetline	GasSLX	Fleetline	GasSLX

### PETERBILT AMORTIGUADORES DE CABINA (Cont.)

	Modelos con Suspensión de Cabina PowerPacker	PP2582870	OIO	<b>83012</b>
	Modelos con Suspensión Link Cab	1202-0022	OIO	<b>83046</b>
	Modelos Convencionales 377 & 379 con Cabina Unibuilt	29-02455	OIO	<b>83008</b>
		R71-6007	OIO	<b>83008</b>
<b>06 - 13</b>	Modelos Day Cab 335 con Número de E.O.	1202P055	OIO	<b>83061</b>
<b>- 14</b>	Modelos Day Cab 337 con Número de E.O.	1202P055	OIO	<b>83061</b>
	Modelos Day Cab 389 con Número de E.O.	20-19140	OIO	<b>83063</b>
		R71-6006	OIO	<b>83063</b>
	Suspensiones Day Cab con Número de E.O.	20-16755	OIO	<b>83042</b>
	Tractos Convencionales Modelos 359 (Modelos Anteriores) con Modelo Link Cabmate PBCAL359	1201-0012	OIO	<b>83023</b>
		1202-0012	OIO	<b>83023</b>

### PIERCE MANUFACTURING INC.

	Camiones de Bomberos Pierce con Número de E.O.	680401	OIO	<b>85307</b>	...	...	...
	Intercambios Adicionales de E.O.	1445910	OIO	<b>85300 or 89419</b>			
		40-0242	OIO	<b>83312 or 89409</b>			
		40-4845	OIO	<b>85304</b>			
		40-4951	-IO	<b>85316 or 89426</b>			
		40-5348	OIO	<b>85058 or 89431</b>			
		40-6967	OIO	<b>85030 or 89440</b>			





### POWERPACKER AMORTIGUADORES DE CABINA

	Modelos con Suspensión de Cabina PowerPacker	PP1058870	OIO	<b>83059</b>
		PP1059870	OIO	<b>83060</b>

### PREVOST

	Autobús Foráneo con Número de E.O.	481700999427	OIO	<b>85380</b>	...	...	...
		630228	OIO	<b>85380</b>	...	...	...
		680583	OIO	<b>85380</b>	...	...	...
<b>89 - 00</b>	Autobús Foráneo XL-45 Amortiguadores de Eje Motriz y Tarjeta  con Suspensión Delantera Viga en I	481700999386		...	...	OIO	<b>85736</b>
		630127		...	...	OIO	<b>85736</b>
		650407		...	...	OIO	<b>85736</b>
		481700999376	OIO	<b>85329</b>	...	...	...
		630134	OIO	<b>85329</b>	...	...	...
		680422	OIO	<b>85329</b>	...	...	...
<b>04 - 09</b>	Autobús Modelo H3 , H3 VIP Amortiguadores de Eje Motriz y Tarjeta  con Suspensión Delantera Viga en I  VIP con Suspensión Delantera Independiente	630253		...	...	OIO	<b>85713</b>
		481700999386		...	...	OIO	<b>85736</b>
		630127		...	...	OIO	<b>85736</b>
		650407		...	...	OIO	<b>85736</b>
		630252	OIO	<b>85329</b>	...	...	...
		481700999376	OIO	<b>85329</b>	...	...	...
		630134	OIO	<b>85329</b>	...	...	...
		680422	OIO	<b>85329</b>	...	...	...
		481700000208	OIO	<b>85379</b>	...	...	...
		630251	OIO	<b>85379</b>	...	...	...
	Autobús X3-45 Amortiguadores de Eje Motriz y Tarjeta con Suspensión Delantera Independiente con Suspensión Delantera Viga en I	630253		...	...	OIO	<b>85713</b>
		630136	OIO	<b>85330</b>	...	...	...
		481700000206	OIO	<b>85380</b>	...	...	...
		630254	OIO	<b>85380</b>	...	...	...
<b>07 - 09</b>	Autobús XL II MTH Amortiguadores de Eje Motriz y Tarjeta Suspensión Delantera	630253		...	...	OIO	<b>85713</b>
		630136	OIO	<b>85330</b>	...	...	...

**GUÍA DE APLICACIONES – CAMIONES, TRÁILERS Y AUTOBUSES**

Año	Modelo	# E.O.	Delantero		Trasero	
						
			Fleetline	GasSLX	Fleetline	GasSLX





**PREVOST (Cont.)**

04 - 06	Autobús XL II, XL II MTH Amortiguadores de Eje Motriz y Tarjeta	630253						
		481700999386			010	85713	...	
		630127			010	85736	...	
		650407			010	85736	...	
		48170000208	con Suspensión Delantera Independiente	01-	85379	...	...	
		630251		01-	85379	...	...	
		481700999377		01-	85330	...	...	
		630163		01-	85330	...	...	
		630252	con Suspensión Delantera Viga en I	010	85329	...	...	
		481700999376		010	85329	...	...	
		630134		010	85329	...	...	
		680422		010	85329	...	...	
		630136	Autobuses Foráneos Modelos LeMirage XL 40 ft, 45 ft, & H con Suspensión Delantera Independiente	01-	85330	...	...	
		481700999376	Autobuses Foráneos VIP LeMirage XL 40 ft, 45 ft, & H3-45 con Suspensión Delantera Viga en I	010	85329	...	...	
		630134		010	85329	...	...	
N16249	Modelos de Autobús Piso Bajo con Número de E.O.		...	...	010	85378	...	
Modelos con Número de E.O.	12L-5-89		...	...	01-	85729	...	
	12T-1-13		<b>85303 or 89422</b>					
	19501288		...	...	01-	85729	...	
	19501289		-1-	85728	...	...		
	48170000207		010	85329	...	...		
	48170000209			...	...	010	85713	...
	630103		010	85329	...	...		
	630161			...	...	010	85736	...
	630234		010	85329	...	...		
	630235		01-	85330	...	...		
	630236		010	85329	...	...		
	680510		01-	85330	...	...		
	G5008070		010	85700	...	...		
Intercambios Adicionales de E.O.	01-0100-905		010	<b>85303 or 89422</b>				
	0822045526		010	<b>85702</b>				
	12B-5-1		010	<b>85735</b>				
	196347		-10	<b>85710</b>				
	196533		-1-	<b>85708</b>				
	3166657		010	<b>85700</b>				
	481700999377		01-	<b>85330</b>				
	52001		-1-	<b>85708</b>				
	630001		010	<b>85713</b>				
	630080		010	<b>85713</b>				
	630091		010	<b>85736</b>				
	630163		01-	<b>85330</b>				
	63-1013		010	<b>85329</b>				
	680323		010	<b>85700</b>				
	680492		010	<b>85713</b>				
	680555		01-	<b>85330</b>				
	690060		010	<b>85713</b>				
	74939852		010	<b>85308 or 89422</b>				
	G1011822		010	<b>85702</b>				
	N22212		010	<b>85700</b>				

**RAMERIZ TRAILER**

Es necesaria la identificación de la suspensión para determinar qué sección del catálogo referir. Posibles opciones pueden ser Chalmers, Hendrickson, Neway, Ridewell, Reyco.						
---	--	--	--	--	--	--

**GUÍA DE APLICACIONES – CAMIONES, TRÁILERS Y AUTOBUSES**

Año	Modelo	# E.O.	Delantero		Trasero	
						
			Fleetline	GasSLX	Fleetline	GasSLX

**RAMERIZ TRAILER (Cont.)**

**Trailer (Cont.)**

Suspensión Slider Air 86 AR / RS 1015, 1035, 3035	18165-01	...	...	010	<b>85006</b>	...
---	----------	-----	-----	-----	--------------	-----

**RAYDAN MANUFACTURING**

Suspensión Air Link AL460	700115	...	...	010	<b>85712</b>	...
Suspensión Air Link AL520	700115	...	...	010	<b>85712</b>	...
Suspensiones Air Link con Número de E.O.	14QK-3100	...	...	010	<b>85739</b>	...
	446-51-211	...	...	010	<b>85739</b>	...

**RED LION TRAILER**

Tráilers con Suspensión de Aire Neway con Número de E.O.	90045019	...	...	010	<b>85913</b>	...
Tráilers con Suspensión de Aire Neway RL196-14, -15	90044978	...	...	010	<b>85059</b>	...

**REINKE MANUFACTURING COMPANY, INC.**

Es necesaria la identificación de la suspensión para determinar qué sección del catálogo referir. Posibles opciones pueden ser Chalmers, Hendrickson, Neway, Ridewell, Reyco.

**REYCO SUSPENSION**

**Aplicaciones Adicionales**

Modelos con Número de E.O.	16824-01	...	...	010	<b>85006</b>	...
	17142-01	...	...	010	<b>85001</b>	89410
	20960-01	...	...	010	<b>83204</b>	...
	23106-01	...	...	010	<b>85975</b>	...
	23614-01	...	...	010	<b>85717</b>	...
	665519	...	...	010	...	89414
	665813	...	...	010	<b>85051</b>	...
	665830	...	...	010	<b>85045</b>	...
	665833	...	...	010	<b>85052</b>	...
	671707	...	...	010	<b>85052</b>	...
	680551	...	...	010	<b>85738</b>	...
	680552	...	...	010	<b>85938</b>	...
	680700	...	...	010	<b>85938</b>	...
	700098-01	010	<b>83203</b>	89436	...	...
	702135-01	...	...	010	<b>85045</b>	...
	702136-01	...	...	010	<b>85052</b>	...
	702209-01	...	...	010	<b>85014</b>	...
	704672-01	...	...	010	<b>85938</b>	...

**Eje de Dirección**

Modelos (Alternativos) 1209	17408-01	010	<b>85005</b>	89430	...	...
Modelos 1200 (Spartan Option)	21310-01	010	<b>85307</b>	...	...	...
Modelos 1207	17403-01	010	<b>83122</b>	89406	...	...
Modelos 1209, 1212	17358-01	010	<b>83126</b>	89430	...	...
	19495-01	010	<b>83126</b>	89440	...	...
Modelos 21B	14954-01	010	<b>83217</b>	...	...	...

**Eje Motriz**

102AR para Modelos Western Star	19824-01	...	...	010	<b>85006</b>	...
21AR - 25000 lb de Capacidad	12887-01	...	...	010	<b>85013</b>	89414
	12887-02	...	...	010	<b>85013</b>	89414
74AR - Capacidad 30000 lb	12887-01	...	...	010	<b>85013</b>	89414
	12887-02	...	...	010	<b>85013</b>	89414
Modelos 101A, 101AR	18166-01	...	...	010	<b>85704</b>	...
Modelos 102	16725-01	...	...	010	<b>83221</b>	...
Modelos 102AR (Estándar)	12887-01	...	...	010	<b>85013</b>	89414
	12887-02	...	...	010	<b>85013</b>	89414
Modelos 102AR (HD)	18286-01	...	...	010	...	89414
Modelos 102AR (Special)	17146-01	...	...	010	<b>83209</b>	89414

## GUÍA DE APLICACIONES – CAMIONES, TRÁILERS Y AUTOBUSES

Año	Modelo	# E.O.	Delantero			Trasero		
			Fleetline	GasSLX				

### REYCO SUSPENSION (Cont.)

#### Eje Motriz (Cont.)

Modelos 102AR-7	17794-01	...	...	010	<b>83215</b>	...
Modelos 102AR-LM	19623-01	...	...	010	<b>83123</b>	<b>89405</b>
Modelos 200 con Suspensión de Aire	20129-01	...	...	010	<b>85007</b>	<b>89412</b>
Modelos 200 con Suspensión de Aire con Número de E.O.	22062-01	...	...	010	<b>85007</b>	<b>89412</b>
Modelos 79AR	12887-02	...	...	010	<b>85013</b>	<b>89414</b>
Modelos 79KB	16725-01	...	...	010	<b>83221</b>	...
Modelos Drive 102W	21497-01	...	...	010	<b>85005</b>	<b>89430</b>
Suspensión de Aire 240AR con Número de E.O.	20125-01	...	...	010	<b>85030</b>	<b>89440</b>
	20126-01	...	...	010	...	<b>89440</b>
	20129-01	...	...	010	<b>85007</b>	<b>89412</b>
Suspensión de Aire AirGlide 400	20129-01	...	...	010	<b>85007</b>	<b>89412</b>

#### Trailer

Modelos 19AR / RS1062 con Número de E.O.	700098-03	...	...	010	<b>85052</b>	...
Modelos 20 AR / RS 3162 con Número de E.O.	18163-01	...	...	010	<b>83207</b>	<b>89407</b>
Modelos 21B (Special)	18800-01	...	...	010	<b>83203</b>	<b>89436</b>
Modelos 23 ART con Número de E.O.	23523-01	...	...	010	<b>85086</b>	...
	665748	...	...	010	<b>85086</b>	...
Modelos 25 ART con Número de E.O.	24392-01	...	...	010	<b>85051</b>	...
Modelos 25 ARU con Número de E.O.	23553-01	...	...	010	<b>85938</b>	...
Modelos 30 ART con Número de E.O.	23524-01	...	...	010	<b>85738</b>	...
Modelos 30 ARUU - 14 y -15	23553-01	...	...	010	<b>85938</b>	...
Modelos 30 ARUU - 9, -12 y -17	23524-01	...	...	010	<b>85738</b>	...
Modelos 30 ARUUL - 12 y -17	23524-01	...	...	010	<b>85738</b>	...
Modelos 30 ARUUL - 9, -14 y -15	23553-01	...	...	010	<b>85938</b>	...
Modelos 81C	12885-03	...	...	010	<b>85300</b>	<b>89419</b>
Modelos 81LC	12885-01	...	...	010	<b>85300</b>	<b>89419</b>
Modelos 81LM	12886-01	...	...	010	<b>85334</b>	...
Modelos 81S	12885-03	...	...	010	<b>85300</b>	<b>89419</b>
Modelos 87 para Great Dane	18163-01	...	...	010	<b>83207</b>	<b>89407</b>
	18164-01	...	...	010	<b>83122</b>	<b>89406</b>
Modelos 87-14 (Montaje Trasero)	18146-01	...	...	010	<b>85313</b>	...
Modelos 87-14, -17	16230-01	...	...	010	<b>85702</b>	...
Modelos 87-6, 87-9	12885-01	...	...	010	<b>85300</b>	<b>89419</b>
Modelos 87M-12	18146-01	...	...	010	<b>85313</b>	...
Modelos Slider 87-14, -17	12885-01	...	...	010	<b>85300</b>	<b>89419</b>
Suspensión Slider Air 86 AR / RS 1015, 1035, 3035	18165-01	...	...	010	<b>85006</b>	...





### RIDEWELL CORPORATION

#### Air-Rides para Tráiler

RAR-210 con Bolsas de Aire Lobulares	AS789B	...	...	010	<b>85014</b>	...
	S5878B	...	...	010	<b>83207</b>	<b>89407</b>
	.....	...	...	010	<b>85006</b>	...
	.....	...	...	010	<b>83207</b>	<b>89407</b>
	.....	...	...	010	<b>85005</b>	<b>89430</b>
RAR-210 Eje Tarjeta	AS563B	...	...	010	<b>83203</b>	<b>89436</b>
	S6009B	...	...	010	<b>83203</b>	<b>89436</b>
RAR-210 para Tráilers con altura de descarga de 25"	1253069B000	...	...	010	<b>85005</b>	<b>89430</b>
	AS30698	...	...	010	<b>85005</b>	<b>89430</b>



**GUÍA DE APLICACIONES – CAMIONES, TRÁILERS Y AUTOBUSES**

Año	Modelo	# E.O.	Delantero		Trasero	
						
			Fleetline	GasSLX	Fleetline	GasSLX

**RIDEWELL CORPORATION (Cont.)**

**Air-Rides para Tráiler (Cont.)**

RAR-210 para Tráilers con altura de descarga de 25"	AS3069B	...	...	010	<b>85005</b>	89430
RAR-221 Eje Tarjeta	AS563B	...	...	010	<b>83203</b>	89436
	AS789B	...	...	010	<b>85014</b>	...
	S5878B	...	...	010	<b>83207</b>	89407
	S6009B	...	...	010	<b>83203</b>	89436
RAR-240, RAR-240W (Tráilers Mono Pivote con Suspensión de Aire HD) con Número de E.O.	1270563B000	...	...	010	<b>85000</b>	89436
	1270563B003	...	...	010	<b>85934</b>	...
	1270789B000	...	...	010	<b>85014</b>	...
RAR-243 (Tráilers Mono Pivote con Suspensión de Aire HD)	1270563B003	...	...	010	<b>85934</b>	...
Suspensión de Aire FeatherRide Light Duty RAR - 244 (Capacidad de 8,000 lb)	1270007	...	...	010	<b>85045</b>	...
Suspensión de Aire Overslung RAR-260 (Capacidad de 25,000 lb)	1270563B003	...	...	010	<b>85934</b>	...
Suspensión de Aire para Tráiler Modelos RideLite	1270563B003	...	...	010	<b>85934</b>	...
Suspensión de Aire Underslung RAR-260 (Capacidad de 25,000 lb y 30,000 lb)	1270563B003	...	...	010	<b>85934</b>	...
Tráiler RAR-221-11, 12, 13-USW con Amortiguador y Percha	AS563B	...	...	010	<b>83203</b>	89436
	S6009B	...	...	010	<b>83203</b>	89436
Tráiler RAR-221AS-11-USW, RAR-221AS-11-1-USW	1253069B000	...	...	010	<b>85005</b>	89430
	AS30698	...	...	010	<b>85005</b>	89430
	AS3069B	...	...	010	<b>85005</b>	89430
Tráiler RAR-221AS-12-USW, RAR-221AS-12-1-USW	1250546B000	...	...	010	<b>85006</b>	...
	AS546B	...	...	010	<b>85006</b>	...
Modelos con Número de E.O.	1275943B	...	...	010	<b>85005</b>	89430
	57645	...	...	010	<b>85005</b>	89430
	665526	...	...	010	<b>85014</b>	...

**Suspensión de Aire - Bus y Camper**

Camper con Suspensión de Aire	AS563B	...	...	010	<b>83203</b>	89436
	S6009B	...	...	010	<b>83203</b>	89436
Suspensión de Aire Ejes de Dirección Modelos RAS - 227 con Número de E.O.	1260008	...	...	010	<b>87017</b>	...
	90-2610 SP1	...	...	010	<b>87017</b>	...

**Truck Air-Rides**

Camión de Bomberos con Suspensión Delantera Ridewell	AS 4025B	010	<b>85712</b>	...	...	...
Eje de Empuje con Levantamiento	AS563B	...	...	010	<b>83203</b>	89436
	S6009B	...	...	010	<b>83203</b>	89436
Eje de Empuje Levantado con Autodirección RSS-236, RSS-236R (Capacidad de 13000 lb & 16000 lb)	1253069B000	...	...	010	<b>85005</b>	89430
	AS30698	...	...	010	<b>85005</b>	89430
	AS3069B	...	...	010	<b>85005</b>	89430
RAD-221R Eje Motriz	S2607B	...	...	010	<b>85702</b>	...
	S5477B	...	...	010	<b>85307</b>	...
RD-202B Eje Motriz Tándem	S5478B	...	...	010	<b>85307</b>	...
RD-202S-54-48-BS Suspensión de Aire Tandem Drive	1252607B000	...	...	010	<b>85702</b>	...
RD-202S-54-52T-SR Suspensión de Aire Tandem Drive	1252607B000	...	...	010	<b>85702</b>	...
RUA-220B-1-, 10, 10.5, 11, 11.5, 12, 12.5, 13 (Eje Tarjeta Levantado & Suspensión Levantado para Tráiler)	1250789B000	...	...	010	<b>85014</b>	...
	AS789B000	...	...	010	<b>85014</b>	...
RUA-220B-1-, 7, 7.5, 8, 8.5, 9, 9.5, 10 (Eje Tarjeta Levantado & Suspensión Levantado para Tráiler)	1270563B000	...	...	010	<b>85000</b>	89436
Suspensión de Aire Modelos RCA-215 (RCA-215 LM, RCA-215 MM)	1250789B000	...	...	010	<b>85014</b>	...
	1250563B000	...	...	010	<b>85000</b>	89436
Modelos con Número de E.O.	1252607B000	...	...	010	<b>85702</b>	...
	1253069B000	...	...	010	<b>85005</b>	89430

## GUÍA DE APLICACIONES – CAMIONES, TRÁILERS Y AUTOBUSES

Año	Modelo	# E.O.	Delantero		Trasero	
			Fleetline	GasSLX	Fleetline	GasSLX

### RIDEWELL CORPORATION (Cont.)

#### Truck Air-Rides (Cont.)

Modelos con Número de E.O.	1254190B000	...	...	010	<b>85302</b>	<b>89420</b>
	12651527B000	...	...	010	<b>85712</b>	...
	1266009B000	...	...	010	<b>83130</b>	...
	1267120B000	...	...	010	<b>85734</b>	...
	1267395B000	...	...	010	<b>85302</b>	<b>89420</b>
	1275813B000	...	...	010	<b>85704</b>	...
	665198	...	...	010	<b>85005</b>	<b>89430</b>
	665267	...	...	010	<b>85029</b>	...
	680101	...	...	010	<b>85702</b>	...
	70654	...	...	010	<b>85000</b>	<b>89436</b>
	AS575B	...	...	010	<b>85005</b>	<b>89430</b>
	S4025B	...	...	010	<b>85712</b>	...
	S5813B	...	...	010	<b>85704</b>	...
	S7120B	...	...	010	<b>85304</b>	...
	S7172B	...	...	010	<b>83207</b>	<b>89407</b>
	S7249B	...	...	010	<b>85307</b>	...
S7365B	...	...	010	<b>85305</b>	...	
Intercambios Adicionales de E.O.	1250005	010	<b>85901</b>			
	1254025B000	010	<b>85712</b>			
	1265478B000	010	<b>85736</b>			
	1267249B000	010	<b>85712</b>			

### ROADMASTER (MONACO)









Modelos con Número de E.O.	90045188	...	...	010	<b>85910</b>	...
Modelos con Suspensión AD-123 (AD123-6,-8,-10,-8.75)	90045132	...	...	010	<b>85909</b>	...

### SAF HOLLAND

#### Suspensión de Aire para Camión & Tractor (Eje Tarjeta)

Modelos con Número de E.O.	57639	...	...	010	<b>85000</b>	<b>89436</b>
	57643	...	...	010	<b>85013</b>	<b>89414</b>
	6025	...	...	010	<b>83122</b>	<b>89406</b>
	6026	...	...	010	<b>83204</b>	...
	665197	...	...	010	<b>85051</b>	...
	665514	...	...	010	<b>83127</b>	...
	665969	...	...	010	...	<b>89430</b>
	90044001	...	...	010	<b>85005</b>	<b>89430</b>
	90044071	...	...	010	<b>85000</b>	<b>89436</b>
	90044081	...	...	010	<b>85000</b>	<b>89436</b>
	90044086	...	...	010	<b>85000</b>	<b>89436</b>
	90044089C	...	...	010	<b>83124</b>	<b>89407</b>
	90044095	...	...	010	<b>83203</b>	<b>89436</b>
	90044679	...	...	010	<b>83122</b>	<b>89406</b>
	90044680	...	...	010	<b>83125</b>	...
	90044681	...	...	010	<b>83204</b>	...
	90044682	...	...	010	<b>83209</b>	<b>89414</b>
	90044683	...	...	010	<b>83122</b>	<b>89406</b>
	90044684	...	...	010	<b>83124</b>	<b>89407</b>
	90044685	...	...	010	<b>83128</b>	...
	90044686	...	...	010	<b>85051</b>	...
	90044687	...	...	010	<b>83125</b>	...
	90044688	...	...	010	<b>83122</b>	<b>89406</b>
	90044770	...	...	010	<b>83207</b>	<b>89407</b>
	90044833	...	...	010	<b>85052</b>	...
	90044834	...	...	010	<b>85052</b>	...

## GUÍA DE APLICACIONES – CAMIONES, TRÁILERS Y AUTOBUSES

Año	Modelo	# E.O.	Delantero		Trasero	
						
						
			Fleetline	GasSLX	Fleetline	GasSLX

### SAF HOLLAND (Cont.)





#### Suspensión de Aire para Camión & Tractor (Eje Tarjeta) (Cont.)

Modelos con Número de E.O.	90044878	...	...	01-	83635	...
	90044915	...	...	010	83127	...
	90044981	...	...	010	85000	89436
	90044982	...	...	010	85000	89436
	90044991	...	...	010	85000	89436
	90045110	...	...	010	83121	...
	90045175	...	...	010	85916	...
	90045384	...	...	010	...	89430
	AR-1008	...	...	010	85006	...
	AR-1141	...	...	010	83204	...
	AR-1141-C	...	...	010	83204	...
	AR-1202	...	...	010	85300	89419
	AR-134-C	...	...	010	85005	89430
	AR-1404	...	...	010	85301	...
	AR-1425	...	...	010	85301	...
	AR-1434	...	...	010	83203	89436
	AR-1654	...	...	010	83209	89414
	AR-1822	...	...	010	85304	...
	AR-2451	...	...	010	83203	89436
	AR-2598	...	...	010	83123	89405
	AR-718-C	...	...	010	83203	89436
	AR-718-C-HD	...	...	010	85000	89436
	AR-781	...	...	010	83203	89436
	AR-958	...	...	010	83207	89407
	AR-995	...	...	010	85734	...

#### Suspensión de Aire para Tráiler

Suspensión de Aire con Levantamiento Auxiliar sin Dirección Modelos NL-200 (NL-200-1S, NL-200-2S)	90044162	...	...	010	83128	89436
Suspensión de Aire para Tráiler Modelos AR-120 (AR-120, AR-120-L, AR-120-US, AR-120-US-F) (AR-120-US-L, -1, -2, -3)	90044626 90044625	...	...	010	83126	89430
Suspensión de Aire para Tráiler Modelos AR-125 (AR-125, AR-125-L, AR-125-US, AR-125-US-F) (AR-125-US-L, -1, -2, -3)	90044626 90044625	...	...	010	83126	89430
Suspensión de Aire para Tráiler Modelos AR-165-US	90044626	...	...	010	83126	89430
Suspensión de Aire para Tráiler Modelos AR-250 (AR-250-12) (AR-250-14, -15) (AR-250-16, -17)	90045054 90044642 90044089	...	...	010	85051	...
Suspensión de Aire para Tráiler Modelos AR-41 Todos	90044162	...	...	010	83128	89436
Suspensión de Aire para Tráiler Modelos AR-45 (AR-45, AR-45-1)	90044162	...	...	010	83128	89436
Suspensión de Aire para Tráiler Modelos AR-50 (AR-50-US, AR-50-US-F, -1, -2)	90044162	...	...	010	83128	89436
Suspensión de Aire para Tráiler Modelos AR-51 (AR51-US)	90044162	...	...	010	83128	89436
Suspensión de Aire para Tráiler Modelos AR-70 (AR-70-9, -14, AR-70A-9, 14)	90044626	...	...	010	83126	89430
Suspensión de Aire para Tráiler Modelos AR-75 (AR-75-12) (AR-75-6, -9, -1-12)	90044625 90044626	...	...	010	83125	...
Suspensión de Aire para Tráiler Modelos AR-80 (AR-80-6.75) (AR-80-9, -9FM)	90044046 90044868	...	...	010	83123	89405
		...	...	010	85045	...

**GUÍA DE APLICACIONES – CAMIONES, TRÁILERS Y AUTOBUSES**





Año	Modelo	# E.O.	Delantero		Trasero	
			 Fleetline	 GasSLX	 Fleetline	 GasSLX

**SAF HOLLAND (Cont.)**

**Suspensión de Aire para Tráiler (Cont.)**

(AR-80-9-WST)	90044626	...	...	010	<b>83126</b>	<b>89430</b>
Suspensión de Aire para Tráiler Modelos AR-85-A (AR-85-A)	90044625	...	...	010	<b>83125</b>	...
Suspensión de Aire para Tráiler Modelos AR-90 (AR-90-14, -15, -16, -17)	90044089	...	...	010	<b>83124</b>	<b>89407</b>
Suspensión de Aire para Tráiler Modelos AR-90-1 (AR-90-1-12, -14, -17) (AR-90-1-15, -16)	90044162	...	...	010	<b>83128</b>	<b>89436</b>
	90044448	...	...	010	<b>85051</b>	...
	90045054	...	...	010	<b>85051</b>	...
Suspensión de Aire para Tráiler Modelos AR-92 (AR-92-12) (AR-92-14) (AR-92-15) (AR-92-16) (AR-92-17) (AR-92-18)	90044162	...	...	010	<b>83128</b>	<b>89436</b>
	90044992	...	...	010	<b>85000</b>	<b>89436</b>
	90045040	...	...	010	<b>83130</b>	...
	90044448	...	...	010	<b>85051</b>	...
	90045054	...	...	010	<b>85051</b>	...
	90044794	...	...	010	<b>83127</b>	...
	90044642	...	...	010	<b>83127</b>	...
	90044089	...	...	010	<b>83124</b>	<b>89407</b>
90044769	...	...	010	<b>83207</b>	<b>89407</b>	
Suspensión de Aire para Tráiler Modelos AR-93 (AR-93-14) (AR-93-15) (AR-93-16) (AR-93-17)	90044448	...	...	010	<b>85051</b>	...
	90045054	...	...	010	<b>85051</b>	...
	90044794	...	...	010	<b>83127</b>	...
	90044642	...	...	010	<b>83127</b>	...
	90044089	...	...	010	<b>83124</b>	<b>89407</b>
90044769	...	...	010	<b>83207</b>	<b>89407</b>	
Suspensión de Aire para Tráiler Modelos AR-94	90045028	...	...	010	<b>85907</b>	...
	90045048	...	...	010	<b>85905</b>	...
	90045049	...	...	010	<b>85905</b>	...
Suspensión de Aire para Tráiler Modelos AR-95 (AR-95-9, -12, -14, -17, All -HD Models, AR-95A-9, -12, -14, -17)	90044625	...	...	010	<b>83125</b>	...
Suspensión de Aire para Tráiler Modelos AR-955 (Eje Levantado) (AR-955-9, -12, -14, -17) (AR-955-9HD, -12HD, -14HD, -17HD) (AR-955A-9, -12, -14, -17) (AR-955A-9HD, -12HD, -14HD, -17HD)	90044625	...	...	010	<b>83125</b>	...
	90044625	...	...	010	<b>83125</b>	...
	90044625	...	...	010	<b>83125</b>	...
	90044625	...	...	010	<b>83125</b>	...
Suspensión de Aire para Tráiler Modelos ARA-93 (ARA-93-14)	90045054	...	...	010	<b>85051</b>	...
Suspensión de Aire para Tráiler Modelos ARL-20 (ARL20-D, ARL20-D-US)	90044162	...	...	010	<b>83128</b>	<b>89436</b>
Suspensión de Aire para Tráiler Modelos ARS112	90045096	...	...	010	<b>85916</b>	...
Suspensión de Aire para Tráiler Modelos ARU-92 (ARU-92-8, -9, -10, -12)	90044642	...	...	010	<b>83127</b>	...
Suspensión de Aire para Tráiler Modelos ARU-93 (ARU-93-6) (ARU-93-7, -8, -9, -10)	90045040	...	...	010	<b>83130</b>	...
	90044642	...	...	010	<b>83127</b>	...
Suspensión de Aire para Tráiler Modelos ARU-98 (ARU-98-17)	90045054	...	...	010	<b>85051</b>	...
Suspensión de Aire para Tráiler Modelos CB-2300 (CB-2300-14) (CB-2300-15) (CB-2300-16, CB-2300-17)	90044868	...	...	010	<b>85045</b>	...
	90045381	...	...	010	<b>83150</b>	...
	90045298	...	...	010	<b>83128</b>	...
Suspensión de Aire para Tráiler Modelos CB-400/4000 (CB-400-15.5, CB-400-16.0) (CB-400-16.5, CB-400-17.0)	90045298	...	...	010	<b>83128</b>	...
	90044162	...	...	010	<b>83128</b>	<b>89436</b>

## GUÍA DE APLICACIONES – CAMIONES, TRÁILERS Y AUTOBUSES





Año	Modelo	# E.O.	Delantero		Trasero	
			 Fleetline	 GasSLX	 Fleetline	 GasSLX

### SAF HOLLAND (Cont.)

#### Suspensión de Aire para Tráiler (Cont.)

	(CB-400-18.0)	90045040	...	...	010	<b>83130</b>	...
	Suspensión de Aire para Tráiler Modelos CBX 23 (CBX 23-14) (CBX 23-15) (CBX 23-16, CBX 23-17)	90044868 90045381 90045298	...	...	010	<b>85045</b>	...
	Suspensión de Aire para Tráiler Modelos CBX 25 (CBX 25-14) (CBX 25-16, CBX 25-17)	90045607 90045040	...	...	010	<b>83150</b>	...
	Suspensión de Aire para Tráiler Modelos NS-190 (NS-190-16.0) (NS-190-16.5, NS-190-17.0) (NS-190-18.0)	90044162 90045040 90045054	...	...	010	<b>83128</b>	89436
	Suspensión de Aire para Tráiler Modelos NS-400 (NS-400-16.0) (NS-400-16.5) (NS-400-17.0) (NS-400-18.0)	90045298 90044162 90045299 90045040	...	...	010	<b>83128</b>	89436
	Suspensión de Aire para Tráiler Modelos NS-450 (NS-450-16.0) (NS-450-16.5) (NS-450-17.0) (NS-450-18.0)	90045298 90044162 90045299 90045040	...	...	010	<b>83128</b>	89436
	Suspensión de Aire para Tráiler Modelos RL-196 (RL-196-12) (RL-196-14, -15) (RL-196-16, -17)	90044977 90044978 90044979	...	...	010	<b>83115</b>	...
	Suspensión de Aire para Tráiler Modelos RL-196-16, -17	90044979	...	...	010	<b>83113</b>	...
	Suspensión de Aire para Tráiler Modelos RL-196A (RL-196A-12) (RL-196A-14, -15) (RL-196A-16, -17)	90044162 90045040 90044794	...	...	010	<b>83128</b>	89436
	Suspensión de Aire para Tráiler Modelos RL-228 (RL-228-12-3) (RL-228-14-3, -14-4, -15-3, -16-3) (RL-228-17-3)	90044162 90044642 90044089	...	...	010	<b>83128</b>	89436
	Suspensión de Aire para Tráiler Modelos RL-230 (RL-230-12-3) (RL-230-14-3, -15-3) (RL-230-16-3, -17-3)	90045381 90044642 90044089	...	...	010	<b>83150</b>	...
	Suspensión de Aire para Tráiler Modelos RL-230 (Amortiguador Montado en Percha) (RL-230-14-3, -15-4) (RL-230-16-4) (RL-230-17-4)	90045381 90045299 90045040	...	...	010	<b>83150</b>	89436
	Suspensión de Aire para Tráiler Modelos RL-230 (Bolsa de Aire con Perno) (RL-230-14-3, -15-4, -16-4) (RL-230-17-4)	90044642 90044089	...	...	010	<b>83127</b>	89407
	Suspensión de Aire para Tráiler Modelos RL-250 (Amortiguador Debajo de Plataforma) (RL-250-14-3, -15-4) (RL-250-16-4, -17-4)	90045040 90045299	...	...	010	<b>83130</b>	89436
	Suspensión de Aire para Tráiler Modelos RL-250 (Suspensión Estándar) (RL-250-12) (RL-250-14.0, -15.0)	90045054 90044642	...	...	010	<b>85051</b>	...

**GUÍA DE APLICACIONES – CAMIONES, TRÁILERS Y AUTOBUSES**









Año	Modelo	# E.O.	Delantero		Trasero	
						
			Fleetline	GasSLX	Fleetline	GasSLX

**SAF HOLLAND (Cont.)**

**Suspensión de Aire para Tráiler (Cont.)**

	(RL-250-16.0, -17.0)	90044089		...	...	010	<b>83124</b>	<b>89407</b>
	Suspensión de Aire para Tráiler Modelos RL-300 (Bolsa de Aire con Perno Offset)							
	(RL-300-13)	90045054		...	...	010	<b>85051</b>	...
	(RL-300-14, -15, -16, -17)	90045338		...	...	010	<b>85060</b>	...
	Suspensión de Aire para Tráiler Modelos RL-300 (Suspensión Estándar)							
	(RL-300-12, -13)	90045054		...	...	010	<b>85051</b>	...
	(RL-300-14, -15, -16, -17)	90045338		...	...	010	<b>85060</b>	...
	Suspensión de Aire para Tráiler Modelos RLSA (RLSA-4212, -4812)	90044977		...	...	010	<b>83115</b>	...
	Suspensión de Aire para Tráiler Modelos RLSA (RLSA-4214, -4215, -4814, -4815)	90044978		...	...	010	<b>85059</b>	...
	Suspensión de Aire para Tráiler Modelos RLSA (RLSA-4216, -4217, -4816, -4817)	90044979		...	...	010	<b>83113</b>	...
	Suspensión de Aire para Tráiler Modelos RLSA228 (RLSA-228-4214, -4215, -4216, -4814, -4815, -4816)	90044642		...	...	010	<b>83127</b>	...
	Suspensión de Aire para Tráiler Modelos RLSA228 (RLSA-228-4217, -4817)	90044089		...	...	010	<b>83124</b>	<b>89407</b>
	Suspensión de Aire para Tráiler Modelos RLU-228							
	(RLU-228-10-3)	90044089		...	...	010	<b>83124</b>	<b>89407</b>
	(RLU-228-6-3)	90045040		...	...	010	<b>83130</b>	...
	(RLU-228-7-3)	90044642		...	...	010	<b>83127</b>	...
	(RLU-228-8-3, RLU-228-9-3)	90044626		...	...	010	<b>83126</b>	<b>89430</b>
	Suspensión de Aire para Tráiler Modelos RLU-228 (Producción Actual - c/ Carrera Superior de Eje de 3")							
	(RLU-228-10-3, RLU-228-12-3)	90044642		...	...	010	<b>83127</b>	...
	(RLU-228-6-3)	90045298		...	...	010	<b>83128</b>	...
	(RLU-228-7-3)	90044162		...	...	010	<b>83128</b>	<b>89436</b>
	(RLU-228-8-3)	90045040		...	...	010	<b>83130</b>	...
	(RLU-228-9-3)	90045054		...	...	010	<b>85051</b>	...
	Suspensión de Aire para Tráiler Modelos RLU-228 (Producción Actual - c/ Carrera Superior de Eje de 4")							
	(RLU-228-10-4)	90044642		...	...	010	<b>83127</b>	...
	(RLU-228-8-4)	90044162		...	...	010	<b>83128</b>	<b>89436</b>
	(RLU-228-9-4, RLU-228-12-4)	90044626		...	...	010	<b>83126</b>	<b>89430</b>
	Suspensión de Aire para Tráiler Modelos RLU-228 (Producción Actual - c/ Carrera Superior de Eje de 4") HD							
	(RLU-228-8-4)	90045337		...	...	010	<b>85911</b>	...
	Suspensión de Aire para Tráiler Modelos RLU-228 (Suspensión con Amortiguador de Eje Montado)							
	(RLU-228-8-3)	90044162		...	...	010	<b>83128</b>	<b>89436</b>
	(RLU-228-9-3, RLU-228-10-3, RLU-228-12-3)	90044642		...	...	010	<b>83127</b>	...
	Suspensión de Aire para Tráiler Modelos RLU-250							
	(RLU-250-12)	90044642		...	...	010	<b>83127</b>	...
	(RLU-250-6.5)	90045381		...	...	010	<b>83150</b>	...
	(RLU-250-9)	90044162		...	...	010	<b>83128</b>	<b>89436</b>
	Suspensión de Aire para Tráiler Modelos RLU-250 (Suspensión con Montaje en Plataforma)							
	(RLU-250-12-FMT)	90045054		...	...	010	<b>85051</b>	...
	(RLU-250-6.5-FMT)	90045381		...	...	010	<b>83150</b>	...
	(RLU-250-9-FMT)	90044162		...	...	010	<b>83128</b>	<b>89436</b>
	Suspensión de Aire para Tráiler Modelos RLU-300 (Suspensión Estándar)							
	(RLU-300-6.5)	90045471		...	...	010	<b>83150</b>	...
	(RLU-300-9)	90045337		...	...	010	<b>85911</b>	...
	Modelos con Número de E.O.							
		665454		...	...	010	<b>85045</b>	...
		671931		...	...	010	<b>85916</b>	...
		680234		...	...	010	<b>85906</b>	<b>89407</b>

**GUÍA DE APLICACIONES – CAMIONES, TRÁILERS Y AUTOBUSES**

Año	Modelo	# E.O.	Delantero		Trasero	
						
						
			Fleetline	GasSLX	Fleetline	GasSLX

**SAF HOLLAND (Cont.)**





**Suspensión de Aire para Tráiler (Cont.)**

Modelos con Número de E.O.	# E.O.						
	680268		...	...	010	85323	89436
	90044980		...	...	010	85907	...
	90045000		...	...	010	85906	89407
	90045001		...	...	010	85323	89436
	90045002		...	...	010	85906	89407
	90045003		...	...	010	85323	89436
	90045019		...	...	010	85913	...
	90045080		...	...	010	85912	...
	90045083		...	...	010	85910	...
	90045188		...	...	010	85910	...
	90045207		...	...	010	...	89405
	90045433		...	...	010	85916	...
	90045563		...	...	010	85014	...
	90045564		...	...	010	83128	...
	90045572		...	...	010	85045	...
	90045574		...	...	010	83130	...
	90045575		...	...	010	85051	...
	90045576		...	...	010	83150	...
	90045665		...	...	010	85029	...
	90045666		...	...	010	85051	...
	90045666		...	...	010	83130	...
	90045669		...	...	010	85000	...

**Suspensiones de Aire para Camión, Bus & Motorhome**

ARDTB-125-6A (Nota: amortiguador delantero)	90045050	010	85914	...		...	...
ARDTB-125-6A (Nota: amortiguador trasero)	90045053		...	...	010	85908	...
Eje Tandem AD-252-10	90045132		...	...	010	85909	...
Modelos AD-123 Suspensión de Aire para Camión & Tracto (AD123-6,-8,-10,-8.75)	90045068		...	...	10	...	89441
Modelos AD-123 Suspensión de Aire para Camión & Tracto (AD123-6,-8,-10,-8.75) Montaje de Amortiguador a nivel de la parte inferior de la plataforma	90045099		...	...	010	85906	89407
Modelos AD-123 Suspensión de Aire para Camión & Tracto (AD123-6,-8,-10,-8.75) Montaje de Amortiguador aprox. 2-1/2" arriba de la parte inferior de la plataforma	90045132		...	...	010	85909	...
Modelos AD-130 Suspensión de Aire para Camión & Tracto (AD123-6,-8,-10,-8.75)	90045466		...	...	010	...	89406
Modelos AD-130 Suspensión de Aire para Camión & Tracto con Número de E.O.	90045432		...	...	010	85321	...
Modelos AD-150 Suspensión de Aire para Camión & Tracto	90045075		...	...	010	85911	...
Modelos AD-200 Suspensión de Aire para Camión & Tracto (AD-200-7, -8, -9, -11)	90045138		...	...	010	85910	...
00 - Modelos AD-246 con Altura de Manejo de 10"	90045504		...	...	010	85030	...
Modelos AD-246 Suspensión de Aire para Camión & Tracto (AD246 -6, -8, -10, -8.75)	90045099		...	...	010	85906	89407
	90045132		...	...	010	85909	...
00 - Modelos AD-369 con Altura de Manejo de 10"	90045504		...	...	010	85030	...
Modelos con Número de E.O.	471700000433		...	...	010	85099	...
	471700000436		...	...	010	85030	...
	471700000458		...	...	010	85014	...
	471700000459		...	...	010	85030	...
	471700000460		...	...	010	85097	...
	471700000461		...	...	010	...	89414
	481700000483		...	...	010	85975	...
	481700000484		...	...	010	85974	...
	481700000485		...	...	010	85975	...
	665002		...	...	010	85004	...
	665003		...	...	010	85300	89419

**GUÍA DE APLICACIONES – CAMIONES, TRÁILERS Y AUTOBUSES**

Año	Modelo	# E.O.	Delantero		Trasero	
						
			Fleetline	GasSLX	Fleetline	GasSLX





**SAF HOLLAND (Cont.)**

**Suspensiones de Aire para Camión, Bus & Motorhome (Cont.)**

Modelos con Número de E.O.	671921	...	...	010	<b>85916</b>	...
	671922	...	...	010	...	<b>89405</b>
	671923	...	...	010	...	<b>89440</b>
	680645	...	...	010	<b>85321</b>	...
	90045084	...	...	010	<b>85968</b>	...
	90045336	...	...	010	<b>85014</b>	...
	90045418	...	...	010	<b>85916</b>	...
	90045419	...	...	010	...	<b>89405</b>
	90045420	...	...	010	...	<b>89440</b>
	90045455	...	...	010	<b>85909</b>	...
	90045499	...	...	010	<b>85974</b>	...
	90045500	...	...	010	<b>85975</b>	...
	90045503	...	...	010	<b>85975</b>	...
	90045504	...	...	010	<b>85030</b>	...
	90045532	...	...	010	<b>85030</b>	...
	90045533	...	...	010	<b>85099</b>	...
	90045534	...	...	010	<b>85014</b>	...
	90045535	...	...	010	<b>85097</b>	...
	90045536	...	...	010	...	<b>89414</b>
	90045568	...	...	010	<b>85060</b>	...
90045605	...	...	010	<b>85109</b>	...	
Suspensión de Aire Eje Tarjeta para Camión & Tracto Modelos ART-500 (ART-500-B, ART-500-B-1) (ART-500-US, ART-500-US-A)	90044162 90044008	...	...	010	<b>83128</b>	<b>89436</b>
Suspensión de Aire Eje Tarjeta para Camión & Tracto Modelos ART-505 (ART-505-B, -1, ART-505-C, -1)	90044162	...	...	010	<b>83128</b>	<b>89436</b>
Suspensión de Aire Eje Tarjeta para Camión & Tracto Modelos ART-541 (ART-541B)	90044162	...	...	010	<b>83128</b>	<b>89436</b>
Suspensión de Aire Eje Tarjeta para Camión & Tracto Modelos ART-550 (ART-550-US-1, -2, -3)	90044012	...	...	010	<b>85006</b>	...
Suspensión de Aire Eje Tarjeta para Camión & Tracto Modelos ART-551 (ART-551-B-1) (ART-551-B-2, -3, ART-551-US-1, -2, -3)	90044162 90044017	...	...	010	<b>83128</b>	<b>89436</b>
Suspensión de Aire Eje Tarjeta para Camión & Tracto Modelos ART-555 (ART-555-B-1, ART-555-C-1) (ART-555-B-2, -3, ART555C-2, -3)	90044162 90044642	...	...	010	<b>83128</b>	<b>89436</b>
Suspensión de Aire para Autobús Modelos ARDTB-125 (ARDTB-125-6A)	90044448	...	...	010	<b>85051</b>	...
Suspensión de Aire para Autobús Modelos ARDTB-125 (ARDTB-125-6B)	90045031	...	...	010	<b>85968</b>	...
Suspensión de Aire para Camión & Tracto Modelos ARD-120 (ARD-120-6)	90044025	...	...	010	<b>83209</b>	<b>89414</b>
Suspensión de Aire para Camión & Tracto Modelos ARD-125 ARD-125-6 use en Ford, GM, International Navistar, Mack, White, Western Star, Freightliner ARD-125-8 use en Freightliner, White, Western Star ARD-125-8 use en Mack	90044025 90044011 90044016	...	...	010	<b>83209</b>	<b>89414</b>
Suspensión de Aire para Camión & Tracto Modelos ARD-165 (ARD-165-A, ARD-165-B)	90044011	...	...	010	<b>85004</b>	...
Suspensión de Aire para Camión & Tracto Modelos ARD-190 (ARD-190-B)	90044016	...	...	010	<b>85300</b>	<b>89419</b>
Suspensión de Aire para Camión & Tracto Modelos ARD-234 (ARD-234-6)	90044046	...	...	010	<b>83123</b>	<b>89405</b>



## GUÍA DE APLICACIONES – CAMIONES, TRÁILERS Y AUTOBUSES

Año	Modelo	# E.O.	Delantero		Trasero	
						
			Fleetline	GasSLX	Fleetline	GasSLX

### SAF HOLLAND (Cont.)

#### Suspensiones de Aire para Camión, Bus & Motorhome (Cont.)

Suspensión de Aire para Camión & Tracto Modelos ARD-238 (ARD-238-6)	90044025		...	...	010	83209	89414
Suspensión de Aire para Camión & Tracto Modelos ARD-244 ARD-244-6 use en Ford, GM, International Navistar, Mack, White, Western Star, Freightliner ARD-244-8 use en Freightliner, White, Western Star ARD-244-8 use en Mack	90044025		...	...	010	83209	89414
	90044011		...	...	010	85004	...
	90044016		...	...	010	85300	89419
Suspensión de Aire para Camión & Tracto Modelos ARDAB-120 (ARDAB-120-5)	90044907		...	...	01-	83635	...
Suspensión de Aire para Camión & Tracto Modelos ARDAB-238-5	90044907		...	...	01-	83635	...
Suspensión de Aire para Camión & Tracto Modelos ARDAB-240 (ARDAB-240-5)	90044907		...	...	01-	83635	...
Suspensión de Aire para Camión & Tracto Modelos ARDST-123 (ARDST-123-6, ARDSTM/L-123-6)	90044025		...	...	010	83209	89414
Suspensión de Aire para Camión & Tracto Modelos ARDST-244 (ARDST-244-6)	90044025		...	...	010	83209	89414
Suspensión de Aire para Camión & Tracto Modelos ARDST-246 (ARDST-246-6, ARDSTM/L-246-6)	90044025		...	...	010	83209	89414
Suspensión de Aire para Camión & Tracto Modelos ARDST-250-6	90044025		...	...	010	83209	89414

### SCANIA

02 - 07	Scania K 124 IB Autobús 4X2 Carrocería Busscar e Irizar	489509	-10	87020	...	...	...
02 - 05	Scania K124 IB Autobús 6X2 Carrocería Irizar	489509	-10	87020	...	...	...

### SEAGRAVE FIRE APPARATUS LLC

Modelos con Número de E.O.	680117		...	...	010	85300	89419
	P0025500		...	...	010	85300	89419

### SICARD

Modelos con Número de E.O.	3166657		010	<b>85700</b>			
----------------------------	---------	--	-----	--------------	--	--	--





### SOUTHERN COACH

Autobuses Foráneos para el Ejército de EEUU	.....		010	<b>83217</b>			
Suspensión de Aire - Modelo Inicial	.....		010	<b>85304</b>			
Suspensión de Aire para Modelos Recientes	.....		010	<b>83217</b>			

### SPARTAN MOTORS

Autobuses con Suspensión Hendrickson Softek con Tambor y Discos de Freno	47170000456		010	85959	...	...	...
	58913-009		010	85959	...	...	...
Camión de Bomberos con Número de E.O.	0272-SS5		010	85712	...	...	...
86 Camión de Bomberos con Suspensión Delantera Ridewell	AS 4025B		010	85712	...	...	...
Chasis con Suspensión Hendrickson HTS 210 (Aplicaciones para Autobuses Escolares Tipo C)	60665-025			...	...	010	85036
97 - 00 Chasis MotorHome Alpine / Summit con Número de E.O.	0377-SS5			...	...	010	85029
	B46-1725			...	...	010	85029
Chasis Motorhome con Suspensión Delantera Ridewell	AS 4025B		010	85712	...	...	...
97 - 00 K2 / K3/ MountainMaster con Número de E.O.	B46-2151			...	...	010	85007
91 - 95 K2 / K3/ MountainMaster con Suspensión de Aire Tuthill 102 AR	0346-SS5			...	...	010	85013
	B46-1594			...	...	010	85013
Modelos con Opción de Dirección Reyco 1200	21310-01		010	85307	...	...	...
Modelos con Número de E.O.	59011		010	83214	...	...	...
Intercambios Adicionales de E.O.	78068		010	<b>85304</b>			

**GUÍA DE APLICACIONES – CAMIONES, TRÁILERS Y AUTOBUSES**

Año	Modelo	# E.O.	Delantero		Trasero	
						
			Fleetline	GasSLX	Fleetline	GasSLX

**STERLING TRUCK**

**Cargo Line**

98	Modelos SC-7000 o SC-8000 con Ejes de 12000 o 13000 lb	F6HT-18045-LA	010	85376	...		...	...
98	Modelos SC-7000 o SC-8000 con Muelles Multihojas de 16000 lb	F6HT-18045-AA	010	85054	89438		...	...

**Series A - Line 9500 (SilverStar)**

98 -	Modelos A9513, A9522, AT9513, AT9522 (113" & 122" BBC) con Eje 8500 o 9000 lb y Muelles de 54"	F6HT-18045-HB	010	85054	89438		...	...
		F6HT-18045-HC	010	85054	89438		...	...
98 -	Modelos A9513, A9522, AT9513, AT9522 (113" & 122" BBC) con Eje 8500, 9000 o 10000 lb y Muelles de 54"	F6HT-18045-KA	010	83200	...		...	...
99 -	Modelos con Suspensión de Aire Trasera FAS II	16-15817-000		...	...	010	85724	89443
98 -	Todos los Modelos con Eje 10000 lb o 12000 lb y Muelles de 54"	F6HT-18045-AC	010	85054	89438		...	...
98 -	Todos los Modelos con Eje 12000 lb o 13200 lb, y Muelles de 54"	F6HT-18045-BC	010	85047	89435		...	...
98 -	Todos los Modelos con Eje 12000 lb, 13200 lb o 14600 lb, y Muelles de 60"	F6HT-18045-EB	010	85055	89439		...	...
		F6HT-18045-EC	010	85055	89439		...	...
98 -	Todos los Modelos con Eje 13200 lb o 14600 lb, y Muelles de 54"	F6HT-18045-GC	010	85030	89440		...	...
98 -	Todos los Modelos con Eje 14600 lb o 16000 lb, y Muelles de 54"	F6HT-18045-CC	010	85055	89439		...	...
98 -	Todos los Modelos con Eje 23000 lb y Suspensión Trasera de Muelles Softride de 54"	F6HT-18080-CA		...	...	010	85314	89425
98 -	Todos los Modelos con Eje Tandem Hendrickson 40LH	57241-2		...	...	01-	83109	...
98 -	Todos los Modelos con Suspensión Trasera de Aire FAS II	.....		...	...	010	85724	89443
98 -	Todos los Modelos con Suspensión Trasera de Aire Hendrickson HAS	47902-28		...	...	010	85013	89414
		F6HT-18080-FC		...	...	010	85013	89414

**Series ACTERRA**

	Modelos con Eje Delantero de 11000 a 12000 lb	6803230300	010	85006	...		...	...
- 02	Modelos con Eje Delantero de 6000 lb a 9000 lb	6803230200	010	85043	...		...	...
03 -	Modelos con Eje Delantero de 6000 lb a 9000 lb	10-12388-000	010	85920	...		...	...
09 - 15	Modelos con Suspensión de Aire Trasera FAS II	16-18708-000		...	...	010	85724	89443
		471700002809		...	...	010	85724	89443
		SDA471700002809		...	...	010	85724	89443
99 - 08	Modelos con Suspensión de Aire Trasera FAS II	16-15817-000		...	...	010	85724	89443
		680611		...	...	010	85724	89443
03 -	Modelos con Suspensión de Muelles Taperleaf de 10000 a 12000 lb	10-12390-000	010	85920	...		...	...
- 04/09	Modelos con Suspensión Hendrickson AirTek	58913-003	010	85932	89453		...	...
	Modelos con Suspensión Trasera de 15000 lb	6803260000		...	...	01-	83120	...
09 - 10	Modelos con Eje Delantero desde 10000 hasta 12000 lb y Suspensión de Muelles de 3"	10-13592-000	010	85959	...		...	...
		SDA471700000440	010	85959	...		...	...

**Series L - Line 7500 - Tractor Corto**

	Modelos con Eje Delantero de 10,000 lb	F6HT-18045-KA	010	83200	...		...	...
--	--	---------------	-----	-------	-----	--	-----	-----

**Series L - Line 8500 - Cabina Convencional**

98	Modelos con Eje Tandem Hendrickson 40LH	57241-2		...	...	01-	83109	...
- 98	Modelos con Suspensión de Aire Trasera FAS II	.....		...	...	010	85724	89443
99 -	Modelos con Suspensión de Aire Trasera FAS II	16-15817-000		...	...	010	85724	89443
98	Modelos LT-8000 con Ejes de 12000 o 13000 lb	F6HT-18045-LA	010	85376	...		...	...
98	Modelos LT-8000 con Muelles Multihojas de 16000 lb	F6HT-18045-AA	010	85054	89438		...	...
	Modelos LT-8501 (BBC de 101") con Eje de 8500 o 9000 lb y Muelles Taperleaf de 54"	F6HT-18045-HB	010	85054	89438		...	...
		F6HT-18045-HC	010	85054	89438		...	...
98	Modelos LT-8501 (BBC de 101") con Eje de 8500 o 9000 lb, y Muelles Multihojas de 54"	F6HT-18045-JB	010	83200	...		...	...
		F6HT-18045-JC	010	83200	...		...	...
98	Todos con Suspensión Trasera de Aire Hendrickson HAS	47902-28		...	...	010	85013	89414

## GUÍA DE APLICACIONES – CAMIONES, TRÁILERS Y AUTOBUSES

Año	Modelo	# E.O.	Delantero		Trasero	
			Fleetline	GasSLX	Fleetline	GasSLX

### STERLING TRUCK (Cont.)

#### Series L - Line 8500 - Cabina Convencional (Cont.)

98	Todos con Suspensión Trasera de Aire Hendrickson HAS	F6HT-18080-FC		...	...	OIO	85013	89414
98	Todos los Modelos con Eje 10000 lb o 12000 lb y Muelles de 54"	F6HT-18045-AC	OIO	85054	89438		...	...
98 -	Todos los Modelos con Eje 12000 lb o 13200 lb, y Muelles de 54"	F6HT-18045-BC	OIO	85047	89435		...	...
98 -	Todos los Modelos con Eje 12000 lb, 13200 lb o 14600 lb, y Muelles de 60"	F6HT-18045-EB	OIO	85055	89439		...	...
		F6HT-18045-EC	OIO	85055	89439		...	...
98 -	Todos los Modelos con Eje 13200 lb o 14600 lb, y Muelles de 54"	F6HT-18045-GC	OIO	85030	89440		...	...
98 -	Todos los Modelos con Eje 14600 lb o 16000 lb, y Muelles de 54"	F6HT-18045-CC	OIO	85055	89439		...	...
98 -	Todos los Modelos con Eje 23000 lb y Suspensión Trasera de Muelles Softride de 54"	F6HT-18080-CA		...	...	OIO	85314	89425





#### Series L - Line 9500 - Cabina Convencional

98 -	Modelos con Suspensión de Aire Trasera FAS II	.....		...	...	OIO	85724	89443
98 -	Modelos LT-9501, LT-9511, LT-9513 o LT-9513 (BBC de 113" & 122") con Eje 8500 o 9000 lb, y Muelles Multihojas de 54"	F6HT-18045-JB	OIO	83200	...		...	...
		F6HT-18045-JC	OIO	83200	...		...	...
98 -	Modelos LT-9501, LT-9511, LT-9513 o LT-9513 (BBC de 113" & 122") con Eje de 8500 o 9000 lb y Muelles Taperleaf de 54"	F6HT-18045-HB	OIO	85054	89438		...	...
		F6HT-18045-HC	OIO	85054	89438		...	...
98 -	Todos con Eje 23000 lb y Suspensión Trasera de Muelles Softride de 52"	F6HT-18080-CA		...	...	OIO	85314	89425
98 -	Todos con Suspensión Trasera de Aire Hendrickson HAS	47902-28		...	...	OIO	85013	89414
		F6HT-18080-FC		...	...	OIO	85013	89414
98	Todos los Modelos con Eje 10000 lb o 12000 lb y Muelles de 54"	F6HT-18045-AC	OIO	85054	89438		...	...
98 -	Todos los Modelos con Eje 12000 lb o 13200 lb, y Muelles de 54"	F6HT-18045-BC	OIO	85047	89435		...	...
98 -	Todos los Modelos con Eje 12000 lb, 13200 lb o 14600 lb, y Muelles de 60"	F6HT-18045-EB	OIO	85055	89439		...	...
		F6HT-18045-EC	OIO	85055	89439		...	...
98 -	Todos los Modelos con Eje 13200 lb o 14600 lb, y Muelles de 54"	F6HT-18045-GC	OIO	85030	89440		...	...
98 -	Todos los Modelos con Eje 14600 lb o 16000 lb, y Muelles de 54"	F6HT-18045-CC	OIO	85055	89439		...	...
98 -	Modelos con Eje Tándem Hendrickson 40LH	57241-2		...	...	OI-	83109	...

#### Intercambios Adicionales de E.O.

	Modelos con Suspensión de Aire Trasera FAS II	XC45-18080-BA		...	...	OIO	85724	89443
	Modelos con Suspensión de Aire Trasera Link	1210-0528		...	...	OIO	85904	...
	Modelos con Suspensión Trasera Neway	90045099		...	...	OIO	85906	89407
	Modelos con Número de E.O.	16-15770-000		...	...	OIO	85956	...
		4C4Z-18124-N	OIO	85957	...		...	...
		4C4Z-18125-DA		...	...	OIO	85926	...
		6E7Z-18125-A		...	...	OIO	83146	...
		AT-560	OIO	G63809	...		...	...
		AX-267A	OIO	83309	89446		...	...
		AX-310		...	...	OIO	83215	...
		C4HZ-18124-E	OIO	83309	89446		...	...
		C4TZ-18124-AB	OIO	83308	...		...	...
		D8HZ-18124-A	OIO	85301	...		...	...
		E6HZ-18124-A	OIO	85301	...		...	...
		E6HZ-18124-D	OIO	85301	...		...	...
		E6HZ-18125-D		...	...	OIO	83215	...
		E7HZ-18124-A	OIO	85301	...		...	...
		E7XZ-18124-A	-IO	G63386	...		...	...
		E7XZ-18125-B		...	...	-IO	G63387	...
E9HZ-18124-A	OIO	83309	89446		...	...		

**GUÍA DE APLICACIONES – CAMIONES, TRÁILERS Y AUTOBUSES**

Año	Modelo	# E.O.	Delantero		Trasero	
						
			Fleetline	GasSLX	Fleetline	GasSLX

**STERLING TRUCK (Cont.)**

**Intercambios Adicionales de E.O. (Cont.)**

Modelos con Número de E.O.						
F0HZ-18124-B	010	85006	...		...	...
F1HZ-18124-A	010	83309	89446		...	...
F1HZ-18124-B	010	83308	...		...	...
F1HZ-18124-D	010	85006	89401		...	...
F1HZ-18124-E	010	85006	89401		...	...
F1HZ-18124-H	010	85040	...		...	...
F1HZ-18124-J	010	83308	...		...	...
F1HZ-18124-K	010	...	89402		...	...
F2HZ-18124-A	010	85376	...		...	...
F2HZ-18124-B	010	85301	...		...	...
F4HT-18080-AB		...	...	010	85314	89425
F4HT-18080-BA		...	...	010	85001	89410
F5HZ-18124-A	010	83314	...		...	...
F5HZ-18124-B	010	83107	...		...	...
F5HZ-18124-C	010	85063	...		...	...
F5HZ-18124-D	010	83125	...		...	...
F5HZ-18125-A		...	...	010	85314	89425
F5HZ-18125-B		...	...	010	85001	89410
F6HT-18045-GB	010	85030	89440		...	...
F6HT-18080-B		...	...	01-	83109	...
F6HT-18080-DA		...	...	01-	83109	...
F6HT-18080-EA		...	...	010	85906	89407
F6HT-18080-FC		...	...	010	85013	89414
F6HT-18124-JC	010	83200	...		...	...
F6HT-18124-KA	010	83200	...		...	...
F6HZ-18124-A	010	85054	89438		...	...
F6HZ-18124-B	010	83308	...		...	...
F6HZ-18124-C	010	85055	89439		...	...
F6HZ-18124-D	010	85055	89439		...	...
F6HZ-18124-E	010	85055	89439		...	...
F6HZ-18124-F	010	85055	89439		...	...
F6HZ-18124-G	010	85054	89438		...	...
F6HZ-18124-H	010	85054	89438		...	...
F6HZ-18124-J	010	83200	...		...	...
F6HZ-18125-B		...	...	01-	83109	...
F6HZ-18125-D		...	...	010	85013	89414
F81A-18045-AGB	010	G63809	...		...	...
XC45-18045-AA	010	83216	...		...	...

**STERLING TRUCK AMORTIGUADORES DE CABINA**

	Modelos 8500 & 9500 con Tractos Convencionales BBC de 113" & 122" con Modelos Link Cabmate FH1322 & FH1322-A	1202-1043	010			83025	
	Modelos Acterra con Número de E.O.	18-60768-000	010			83057	
<b>06 - 07</b>	Modelos Acterra con Número de E.O.	18-43504-000	010			83057	
	Modelos AT-9500 con Número de E.O.	F6HZ-5K407-BA	010			83033	
		F8HT-5K407-AA	010			83033	
	Modelos con Número de E.O.	18-45067-000	010			83034	
	Modelos L8501 & L9501 con Tractos Convencionales BBC de 101" con Modelo Link Cabmate FH101	1202-1043	010			83025	
	Modelos LT-9500 con Número de E.O.	F6HZ-5K407-AB	010			83034	

**STOUGHTON TRAILERS INC.**

	Tráilers con Suspensión de Aire Hendrickson HT190T, HT190U, & HS190T	HTA20001		...	...	010	83128	89436
	Tráilers con Suspensión de Aire Hendrickson HT230T	HTA20002		...	...	010	85000	89436
	Tráilers con Suspensión de Aire Neway AR-90-1-12, -14, -17	NW90044162		...	...	010	83128	89436

## GUÍA DE APLICACIONES – CAMIONES, TRÁILERS Y AUTOBUSES

Año	Modelo	# E.O.	Delantero		Trasero	
			Fleetline	GasSLX	Fleetline	GasSLX

### STOUGHTON TRAILERS INC. (Cont.)

	Tráilers con Suspensión de Aire Neway AR-90-1-15, -16	NW90044448		...	...	OIO	<b>85051</b>	...
	Tráilers con Suspensión de Aire Neway RL-196-14, -15	NW90044978		...	...	OIO	<b>85059</b>	...
	Tráilers con Suspensión de Aire Neway RL-196-16, -17	NW90044979		...	...	OIO	<b>83113</b>	...
	Tráilers con Suspensión de Aire Reyco 86AR/RS1015	RT18165-01		...	...	OIO	<b>85006</b>	...
	Tráilers con Suspensión de Aire Reyco con Control de Desinflado 86AR/RS1035	RT18165-01		...	...	OIO	<b>85006</b>	...

### SUSPENSYS

	Suspensión para Tráiler FS230 (Light Duty)	218004872		...	...	OIO	<b>85737</b>	...
--	--	-----------	--	-----	-----	-----	--------------	-----





### THE BINKLEY COMPANY

<b>97</b>	Tráilers con Suspensión Binkley AirLite	16965		...	...	OIO	<b>85006</b>	...
		6898		...	...	OIO	<b>83125</b>	...

### THOMAS SCHOOL BUS

	Autobús Escolar	300-0614966		...	...	OIO	<b>85307</b>	...
		614966		...	...	OIO	<b>85307</b>	...
		614974	OIO	<b>85304</b>	...			...
		680010	OIO	<b>85304</b>	...			...
		680054		...	...	OIO	<b>85307</b>	...
<b>2009</b>	Autobús Escolar SAF-T Liner con Suspensión SAF Holland AD-246	90045504	OIO	<b>85030</b>	...		...	...
<b>2009</b>	Autobús Escolar SAF-T Liner con Suspensión SAF Holland AD-369	90045504	OIO	<b>85030</b>	...		...	...
	Autobús Escolar SAF-T-Liner Modelo MVP-ER & MVP-EF	61300219	OIO	<b>85091</b>	...		...	...
		61300222	OIO	<b>85091</b>	...		...	...
		61300223	OIO	<b>85091</b>	...		...	...
		70445	OIO	<b>85091</b>	...		...	...
<b>09-12</b>	Autobús Escolar Tipo C con Número de E.O.	16-18713-000		...	...	OIO	<b>85122</b>	...
		471700003070		...	...	OIO	<b>85122</b>	...
	Autobuses con Número de E.O.	16-19138-000	OIO	<b>85058</b>	<b>89431</b>		...	...
	Autobuses con Suspensión de Aire Eje Tándem Neway	61310232		...	...	OIO	<b>85000</b>	<b>89436</b>
	Autobuses con Suspensión de Aire Trasera FAS II	61310434		...	...	OIO	<b>85724</b>	<b>89443</b>
		61310478		...	...	OIO	<b>85724</b>	<b>89443</b>
<b>- 12</b>	Autobuses Convencionales Tipo C (Capacidad para 65 personas) con Suspensión de Aire Trasera FAS II	16-15817-000		...	...	OIO	<b>85724</b>	<b>89443</b>
<b>- 15</b>	Autobuses Convencionales Tipo C (Capacidad para 65 personas) con Suspensión de Aire Trasera FAS II	16-18708-000		...	...	OIO	<b>85724</b>	<b>89443</b>
<b>07 - 12</b>	Autobuses Convencionales Tipo C (Capacidad para 65 personas) con Suspensión Delantera Taperleaf 12000 lb	10-13634-000	OIO	<b>85918</b>	<b>89449</b>		...	...
	Modelos MVP	61310101	OIO	<b>85736</b>				
	Modelos SAF-T-Liner HDX con Suspensión de Aire Trasera Hendrickson Comfort Air	471700131545		...	...	OIO	<b>85006</b>	...
		60998-001		...	...	OIO	<b>85006</b>	...
		60998-003		...	...	OIO	<b>85006</b>	...
	ROC Front, SAF-T-Liner	61300285	-I-	<b>83102</b>	...		...	...
<b>2003</b>	Autobuses Escolares Convencionales Tipo C (Capacidad para 65 personas) con Número de E.O.	680-323-0300	OIO	<b>85006</b>	...		...	...
	Modelos con Número de E.O.	128745	-I-	<b>83102</b>	...		...	...
		61300112	-I-	<b>83613</b>	...		...	...
		61300224	OIO	<b>85918</b>	<b>89449</b>		...	...
		61300240	OIO	<b>85918</b>	<b>89449</b>		...	...
		61310102		...	...	OIO	<b>85308</b>	<b>89422</b>
		61310103		...	...	OIO	<b>85308</b>	<b>89422</b>
		651442	-I-	<b>83102</b>	...		...	...
		659287	-I-	<b>83102</b>	...		...	...
		680-326-0000		...	...	OIO	<b>83120</b>	...
		GBL654725		...	...	OIO	<b>83120</b>	...

**GUÍA DE APLICACIONES – CAMIONES, TRÁILERS Y AUTOBUSES**

Año	Modelo	# E.O.	Delantero		Trasero	
						
			Fleetline	GasSLX	Fleetline	GasSLX

**THOMAS SCHOOL BUS (Cont.)**

Modelos con Número de E.O.	GBL665538	010	85006	...	...	...
Intercambios Adicionales de E.O.	6130-0114	010				89437
	6130029	010				85712
	61310104	010				85713
	63-0001	010				85713
	680088	010				85713
	680102	010				85712
	728802	010				85736
	87002	010				85736
	A-4890	010				85712

**Autobús Escolar Tipo A**

92 - 15	Autobús Escolar Minotour Tipo A con Chasis Ford E350	8C24-18045-DA	-10	83177	...	...	...	
		8C24-18080-DB		...	...	-10	83178	...
		8C2Z-18124-D	-10	83177	...	...	...	...
		8C2Z-18125-D		...	...	-10	83178	...
		ASH-1136		...	...	-10	83178	...
		ASH-1154	-10	83177	...	...	...	...
		AT-163G	-10	83177	...	...	...	...
		AT-164G		...	...	-10	83178	...
00 - 15	Autobús Escolar Minotour Tipo A con Chasis Ford E450	8C24-18045-DA	-10	83177	...	...	...	
		8C24-18080-DB		...	...	-10	83178	...
		8C2Z-18124-D	-10	83177	...	...	...	...
		8C2Z-18125-D		...	...	-10	83178	...
		ASH-1136		...	...	-10	83178	...
		ASH-1154	-10	83177	...	...	...	...
		AT-163G	-10	83177	...	...	...	...
		AT-164G		...	...	-10	83178	...

**THOR MOTOR COACH**





**MotorHomes Clase A**

06	MotorHomes Series Astoria & Tuscany con Chasis Freightliner XC	Amortiguador Trasero con Número de E.O.	141700131809					
			16-16736-000			010	85029	...
		Suspensión Delantera AS120	141700131810	010	83160	...	...	...
			16-16737-000	010	83160	...	...	...
			16-16874-000	010	83160	...	...	...
		Suspensión Delantera ZF - IFS con PBV de 23,000 lb o mayor	16-18103-000	-1-	85900	...	...	...
			481700000493	-1-	85900	...	...	...
	Suspensión Trasera ADL200 de 20K	16-16873-000		...	...	010	85029	...
02 - 05	MotorHomes Series Escaper & UltraSport con Chasis Freightliner XC	Amortiguador Trasero con Número de E.O.	141700131809					
			16-16736-000			010	85029	...
		Suspensión Delantera AS120	141700131810	010	83160	...	...	...
			16-16737-000	010	83160	...	...	...
			16-16874-000	010	83160	...	...	...
		Suspensión Delantera ZF - IFS con PBV de 23,000 lb o mayor	16-18103-000	-1-	85900	...	...	...
			481700000493	-1-	85900	...	...	...
	Suspensión Trasera ADL200 de 20K	16-16873-000		...	...	010	85029	...

**TIMBREN INDUSTRIES**

Intercambios Adicionales de E.O.	665804	010				85939
----------------------------------	--------	-----	--	--	--	-------

## GUÍA DE APLICACIONES – CAMIONES, TRÁILERS Y AUTOBUSES

Año	Modelo	# E.O.	Delantero		Trasero	
						
			Fleetline	GasSLX	Fleetline	GasSLX

### TRAIL KING INDUSTRIES

Es necesaria la identificación de la suspensión para determinar qué sección del catálogo referir.  
Posibles opciones pueden ser Chalmers, Hendrickson, Neway, Ridewell, Reyco.



### TRAILMOBILE CANADA CORP.

Tráilers con Modelo de Suspensión de Aire Reyco # 21AR (Capacidad de 25,000 lb)	43-8-002	...	...	010	83209	89414
Tráilers con Modelo de Suspensión de Aire Reyco # 74AR (Capacidad de 30,000 lb)	43-8-002	...	...	010	83209	89414
Tráilers con Modelo de Suspensión de Aire Reyco # 86AR	43-8-015	...	...	010	85006	...
Tráilers con Suspensión de Aire Granning T-350A	43-8-022	...	...	010	83225	...
Tráilers con Suspensión de Aire Hendrickson HT230T (Capacidad de 23,000 lb)	43-6-118	...	...	010	85000	89436
Tráilers con Suspensión de Aire Hendrickson HT250U, HT250U-Y	A-2212	...	...	010	85029	...
Tráilers con Suspensión de Aire Hendrickson T23-RL-17	43-8-011	...	...	010	83207	89407
Tráilers con Suspensión de Aire Hendrickson T23-US-6 (Sin Levantamiento)	43-8-015	...	...	010	85006	...
Tráilers con Suspensión de Aire Hendrickson T23-US-9 (Con & Sin Levantamiento)	43-8-014	...	...	010	85013	89414
Tráilers con Suspensión de Aire Hendrickson T30-US-9, -12, -14, -17	43-8-013	...	...	010	85000	89436
Tráilers con Suspensión de Aire Neway AR90-1-14, AR90-1-17	90044089	...	...	010	83124	89407
Tráilers con Suspensión de Aire Neway AR90-14	90044992	...	...	010	85000	89436
Tráilers con Suspensión de Aire Neway AR90-14, -17,	90044089	...	...	010	83124	89407
Tráilers con Suspensión de Aire Neway AR92-17	90044642	...	...	010	83127	...
Tráilers con Suspensión de Aire Neway AR93-14	90045054	...	...	010	85051	...
Tráilers con Suspensión de Aire Neway AR93-17	90044089	...	...	010	83124	89407
Tráilers con Suspensión de Aire Neway AR95-9-HD, -12-HD, -14-HD, 17-HD	90044625	...	...	010	83125	...
Tráilers con Suspensión de Aire Neway RL196-12	90044977	...	...	010	83115	...
Tráilers con Suspensión de Aire Neway RL196-14, -15	90044978	...	...	010	85059	...
Tráilers con Suspensión de Aire Neway RL196-16, -17	90044979	...	...	010	83113	...
Modelos con Número de E.O.	43-4-235	...	...	010	85051	...
	43-4-236	...	...	010	85029	...
	43-4-237	...	...	010	85000	89436
	43-4-239	...	...	010	83207	89407
	43-4-241	...	...	010	85006	...
	43-4-277	...	...	010	85000	89436
	43-4-278	...	...	010	85059	...
	43-4-279	...	...	010	83204	...
	43-6-028	...	...	010	85000	89436
	43-6-137	...	...	010	85006	...
	43-6-158	...	...	010	85013	89414
	43-6-164	...	...	010	83207	89407
	43-8-031	...	...	010	85029	...

### TRANSPORTATION MFG. CORP

Autobús Foráneo G 4500 (Delantero) (Eje Tarjeta)	12-05-6000	-10	85711	...	...	...
	12-05-6002		...	...	010	85339
	12-05-6033		...	...	010	85339
Autobús Foráneo de 45 ft - Eje Tarjeta			...	...	010	85713
Autobús RTS con "V" Drive Trasero	G1101590		...	...	010	85713
	Autobús RTS con Eje Delantero Rígido	22024673	-10	85710	...	...
	22046485	-10	85710	...	...	...
	680350	-10	85710	...	...	...
	695273	-10	85710	...	...	...
695279	-10	85710	...	...	...	
Autobús RTS con Frente Normal	22012079	-1-	85701	...	...	...
	4975515	-1-	85701	...	...	...

**GUÍA DE APLICACIONES – CAMIONES, TRÁILERS Y AUTOBUSES**

Año	Modelo	# E.O.	Delantero		Trasero	
						
			Fleetline	GasSLX	Fleetline	GasSLX

**TRANSPORTATION MFG. CORP (Cont.)**

Autobús RTS con Frente Normal	695117	- -	<b>85701</b>	...		...	...
	74410	- -	<b>85701</b>	...		...	...
Autobús RTS con Trasero Regular	22045526		...	...	0 0	<b>85702</b>	...
	22052014		...	...	0 0	<b>85702</b>	...
	G1011822		...	...	0 0	<b>85702</b>	...
City Cruiser	12TA-01-13	0 0	<b>85303 or 89422</b>				
Eje Motriz	12J-5-10		...	...	0 -	<b>85733</b>	...
	12J-5-2		...	...	0 -	<b>85312</b>	...
	12J-5-4		...	...	0 -	<b>85312</b>	...
Eje Tarjeta	12J-5-11		...	...	0 0	<b>85313</b>	...
	12J-5-3		...	...	0 0	<b>85313</b>	...
	12J-5-6		...	...	0 0	<b>85313</b>	...
	12J-5-9		...	...	0 0	<b>85700</b>	...
Modelos de Autobús Piso Bajo con Número de E.O.	12L-5-99		...	...	0 0	<b>85339</b>	...
Modelos con Número de E.O.	12B-5-1		...	...	0 0	<b>85735</b>	...
	12G-5-1	0 0	<b>85700</b>	...		...	...
	12T-1-13	0 0	<b>85303 or 89422</b>				
	680349		...	...	0 0	<b>85702</b>	...
680470		...	...	0 0	<b>85713</b>	...	
Intercambios Adicionales de E.O.	12L-5-69	0 0	<b>85700</b>				
	12L-5-70	0 0	<b>85700</b>				

**TRINITY TRAILER MFG., INC.**

Es necesaria la identificación de la suspensión para determinar qué sección del catálogo referir. Posibles opciones pueden ser Chalmers, Hendrickson, Neway, Ridewell, Reyco.							
---	--	--	--	--	--	--	--

**TURNER-QUICK LIFT - SEE HENDRICKSON SUSPENSION**

--	--	--	--	--	--	--	--

**TUTHILL TECHNOLOGIES**

**Eje de Dirección**

Modelos (Alternativos) 1209	17408-01	0 0	<b>85005</b>	<b>89430</b>		...	...
Modelos 1207	17403-01	0 0	<b>83122</b>	<b>89406</b>		...	...
Modelos 1209, 1212	17358-01	0 0	<b>83126</b>	<b>89430</b>		...	...
	19495-01	0 0	<b>83126</b>	<b>89440</b>		...	...
Modelos 21B	14954-01	0 0	<b>83217</b>	...		...	...

**Eje Motriz**









102AR para Modelos Western Star	19824-01		...	...	0 0	<b>85006</b>	...
74AR - Capacidad 30000 lb	12887-01		...	...	0 0	<b>85013</b>	<b>89414</b>
Modelos 101A, 101AR	18166-01		...	...	0 0	<b>85704</b>	...
Modelos 102AR (Estándar)	12887-02		...	...	0 0	<b>85013</b>	<b>89414</b>
Modelos 102AR (HD)	18286-01		...	...	0 0	...	<b>89414</b>
Modelos 102AR (Special)	17146-01		...	...	0 0	<b>83209</b>	<b>89414</b>
Modelos 102AR-7	17794-01		...	...	0 0	<b>83215</b>	...
Modelos 102AR-LM	19623-01		...	...	0 0	<b>83123</b>	<b>89405</b>
Modelos 200 con Suspensión de Aire	20129-01		...	...	0 0	<b>85007</b>	<b>89412</b>
Modelos 79KB	16725-01		...	...	0 0	<b>83221</b>	...
Suspensión de Aire 240AR con Número de E.O.	20125-01		...	...	0 0	<b>85030</b>	<b>89440</b>
	20126-01		...	...	0 0	...	<b>89440</b>

**Trailer**

Modelos 21B (Special)	18800-01		...	...	0 0	<b>83203</b>	<b>89436</b>
Modelos 25 ART con Número de E.O.	24392-01		...	...	0 0	<b>85051</b>	...
Modelos 25 ARU con Número de E.O.	23553-01		...	...	0 0	<b>85938</b>	...
Modelos 30 ARUUL - 12 y -17	23524-01		...	...	0 0	<b>85738</b>	...



## GUÍA DE APLICACIONES – CAMIONES, TRÁILERS Y AUTOBUSES

Año	Modelo	# E.O.	Delantero		Trasero	
						
						
			Fleetline	GasSLX	Fleetline	GasSLX

### TUTHILL TECHNOLOGIES (Cont.)

#### Trailer (Cont.)

	Modelos 81S	12885-03	...	...	OIO	<b>85300</b>	89419
	Modelos 87 para Great Dane	18163-01	...	...	OIO	<b>83207</b>	89407
		18164-01	...	...	OIO	<b>83122</b>	89406
	Modelos 87-14 (Montaje Trasero)	18146-01	...	...	OIO	<b>85313</b>	...
	Modelos 87-14, -17	16230-01	...	...	OIO	<b>85702</b>	...
	Modelos 87-6, 87-9	12885-01	...	...	OIO	<b>85300</b>	89419
	Suspensión Slider Air 86 AR / RS 1015, 1035, 3035	18165-01	...	...	OIO	<b>85006</b>	...
	Modelos con Número de E.O.	1085	...	...	OIO	<b>83214</b>	...
		16824-01	...	...	OIO	<b>85006</b>	...
		17142-01	...	...	OIO	<b>85001</b>	89410
		20960-01	...	...	OIO	<b>83204</b>	...
		21497-01	...	...	OIO	<b>85005</b>	89430
		23614-01	...	...	OIO	<b>85717</b>	...
		2697	...	...	OIO	<b>85712</b>	...
		680162	...	...	OIO	<b>85300</b>	89419
		702135-01	...	...	OIO	<b>85045</b>	...
		702136-01	...	...	OIO	<b>85052</b>	...
		702209-01	...	...	OIO	<b>85014</b>	...
		OE12425	...	...	OIO	<b>83214</b>	...

#### TWIN COACH

	Modelos con Número de E.O.	90044089	...	...	OIO	<b>83124</b>	89407
		90044089C	...	...	OIO	<b>83124</b>	89407
		90044162	...	...	OIO	<b>83128</b>	89436
		AR-718-C-HD	...	...	OIO	<b>85000</b>	89436
		AR-958	...	...	OIO	<b>83207</b>	89407

#### UNITED MANUFACTURING

	Modelos con Número de E.O.	K-96-41	...	...	OIO	<b>85304</b>	...
--	----------------------------	---------	-----	-----	-----	--------------	-----

#### UNIVERSAL COACH

	Modelos con Número de E.O.	12-05-1199	...	...	OIO	<b>85729</b>	...
		680777	...	...	OIO	<b>85729</b>	...

#### UPS TRUCK

	Modelos con Número de E.O.	P117099	...	...	OIO	<b>83120</b>	...
		P117146	OIO	<b>83118</b>	...	...	...



#### UTILITY TRAILER

Es necesaria la identificación de la suspensión para determinar qué sección del catálogo referir. Posibles opciones pueden ser Chalmers, Hendrickson, Neway, Ridewell, Reyco.

#### VAN HOOL

<b>00 - 09</b>	Autobús T2145 y T2150 con Número de E.O. (Amortiguadores de Eje Delantero y Tarjeta)	10685703	...	...	- -	<b>695406</b>	...
		624314570	...	...	- -	<b>695406</b>	...
		90-2291	...	...	- -	<b>695406</b>	...
<b>00 - 09</b>	Autobús T940 y T945	624314570	...	...	- -	<b>695406</b>	...
		90-2291	...	...	- -	<b>695406</b>	...
	Autobuses T811, T812, T813, T814	6243-14040	- -	<b>85708</b>			
		665563	- -	<b>85708</b>			
	Autobuses T815 4D	6243-14040	...	...	- -	<b>85708</b>	...
		665563	...	...	- -	<b>85708</b>	...
	Autobuses TL 13/14	6243-13790	- -	<b>85708</b>			
		665562	- -	<b>85708</b>			

**GUÍA DE APLICACIONES – CAMIONES, TRÁILERS Y AUTOBUSES**

Año	Modelo	# E.O.	Delantero		Trasero	
						
			Fleetline	GasSLX	Fleetline	GasSLX

**VOLKSWAGEN**

	"Modelos Worker 15.190E / 12.140 / 12.170 / 12.180 / 12.210 / 13.150 / 13.170 / 13.180 / 13.190 / 13.210 / 14.140 / 14.150 / 14.170 / 14.180 / 14.200 / 14.220 / 15.170 / 15.180"	TGG513031		...	...	010	<b>85942</b>	...
	16.180 - Beta Urbano / 16.210 / 17.210 - Beta Todos los Modelos	TAR413031	010	<b>85948</b>	...		...	...
	161.70 / 16.200 / 16.220 / 16.300 / 17.210 / 17.220 / 17.300 / 17.310 / 18.310 / 35.300 / 40.300	TAL413031	010	<b>85949</b>	...		...	...
	17.240 / 17.260 Proteus - con Motor Trasero	2TB513031B		...	...	010	<b>85946</b>	...
		2Z0413031A	010	<b>85075</b>	...		...	...
		2Z0513031B		...	...	010	<b>85946</b>	...
	Beta 16.180	2TJ413031	010	<b>85948</b>	...		...	...
	Camión Constellation de 17 / 23 / 24 Ton	2T0413031B	010	<b>85941</b>	...		...	...
	Camión de Basura de 15 / 17 Ton	2T0413031	010	<b>85947</b>	...		...	...
	Camión para Caña de Azúcar de 26 / 31 Ton	TAU413031	010	<b>85949</b>	...		...	...
	Constellation 17250E / 24250E (distancia entre ejes 3650 mm)	TAL513031		...	...	010	<b>85943</b>	...
	Constellation 17250E / 24250E (distancia entre ejes 4340/4800/2507 mm)	TJG513031B		...	...	010	<b>85944</b>	...
	Microbús 7100 / 7120 / 8140 / 8150 / 9150	TAP513031		...	...	010	<b>85074</b>	...
	Microbús de 5.5 Ton	2P0513031		...	...	010	<b>85077</b>	...
	Microbús Dedalus 5.140	2R0413031	-10	<b>85073</b>	...		...	...
	Minibus de 17 / 18 Ton.	2Z0413031C	010	<b>85945</b>	...		...	...
	Minibus Dedalus 8/9 Ton.	2P0413031C	010	<b>85076</b>	...		...	...
	Modelos "Worker 15.190E / 12.140 / 12.170 / 12.180 / 12.210 / 13.150 / 13.170 / 13.180 / 13.190 / 13.210 / 14.140 / 14.150 / 14.170 / 14.180 / 14.200 / 14.220 / 15.170 / 15.180"	2T0413031A	010	<b>85949</b>	...		...	...
	Modelos 15.180E	2S2413031	010	<b>85949</b>	...		...	...
	Modelos 18310	2T0513031A		...	...	010	<b>85950</b>	...
	Modelos Beta 16.210 / 17.210	TAR413031	010	<b>85948</b>	...		...	...
	Modelos con Número de E.O.	2R2513031		...	...	010	<b>85074</b>	...
	Todos los Modelos BETA 16.180 URBANO Y FORÁNEO / BETA 16.210 / 17.210	TAR513031		...	...	010	<b>85951</b>	...
	Worker 8.140 / 8.150 / 8.150FEB / 9.150	2RF513031		...	...	010	<b>85074</b>	...
	Worker 8.140 / 8.150 / 9.150	2RE413031	-10	<b>85073</b>	...		...	...
		2RF413031	-10	<b>85073</b>	...		...	...
	Worker 8.150 / 7.100 / 7.120 / 8.100 / 8.120 / 8.140 - 7 y 8 Ton	2R2413031	-10	<b>85073</b>	...		...	...
		2RE413031	-10	<b>85073</b>	...		...	...
	Worker 8.150FEB / 11.130 / 11.140 / 11.160 / 13.130 / 14.210	TGG413031	010	<b>85940</b>	...		...	...

**VOLKSWAGEN AMORTIGUADORES DE CABINA**

	Amortiguador de Cabina con Número de E.O.	2R0899515	010				<b>83043</b>	
		TJG899515	010				<b>83043</b>	

**VOLVO**

**Camiones Vocacionales**

	Modelos con Suspensión Trasera T-Ride	20433427		...	...	01-	<b>85065</b>	...
		8060026		...	...	01-	<b>85065</b>	...
		8073212		...	...	01-	<b>85065</b>	...
		8075257		...	...	01-	<b>85065</b>	...
	Modelos WX, WXR, WG, AC con Suspensión Trasera Hendrickson HN-402	57241-3		...	...	01-	<b>83112</b>	...
	Modelos WX, WXLL, WXR, WG, AC con Suspensión Trasera de Aire Hendrickson HAS - 400 con Suspensión Trasera de Aire Hendrickson HAS - 460 con Suspensión Trasera de Hendrickson HN-462	47902-24		...	...	010	<b>83121</b>	...
		47902-24		...	...	010	<b>83121</b>	...
		57241-3		...	...	01-	<b>83112</b>	...

**Series C**

	Autobuses C10 & C11		010				<b>85100</b>	
--	---------------------	--	-----	--	--	--	--------------	--

## GUÍA DE APLICACIONES – CAMIONES, TRÁILERS Y AUTOBUSES

Año	Modelo	# E.O.	Delantero		Trasero	
			Fleetline	GasSLX	Fleetline	GasSLX

### VOLVO (Cont.)

#### Series FE (Cont.)

	FE614 Tracto	6790756		...	...	O O	<b>83215</b>	...
		6794358	O O	<b>85040</b>	...		...	...
	FE615, FE715	6772218	O O	<b>85040</b>	...		...	...
		6775412	O O	<b>85040</b>	...		...	...
	FE715 con Muelles Traseras Parabólicas	6790756		...	...	O O	<b>83215</b>	...
	Modelos con Suspensión de Aire Trasera y Número de E.O.	8056892		...	...	O O	<b>85023</b>	<b>89415</b>
	Modelos FE6	6857668	- O	<b>83105</b>	...		...	...
		6876828	- O	<b>83105</b>	...		...	...
	Modelos FE611, FE614 Posteriores al Chasis No. CH419306	6794358	O O	<b>85040</b>	...		...	...
	Modelos FE7 con Eje Delantero arriba de 6.5 Ton	1590439	O O	<b>83104</b>	...		...	...
	Modelos FE7 con Suspensión Trasera de Aire (Eje Motriz)	1591501		...	...	- -	<b>85722</b>	...
	Modelos FE7 hasta Chasis No. 20855	1505190		...	...	- -	<b>85722</b>	...

#### Series N

	Modelos N10 con Eje Delantero de 5.5 Ton.	1593843	O O	<b>83215</b>	...		...	...
	Modelos N11	1-0200-32-888-1	O O	<b>83104</b>	...		...	...
		1591735	O O	<b>83104</b>	...		...	...
		1593843	O O	<b>83215</b>	...		...	...
	Modelos N12	1-0200-32-888-1	O O	<b>83104</b>	...		...	...
		1591735	O O	<b>83104</b>	...		...	...
		1593843	O O	<b>83215</b>	...		...	...
	N12 con Eje Delantero arriba de 6.5 Ton	1590439	O O	<b>83104</b>	...		...	...

#### Series TX

	Autobuses Modelos 7550 y 9700	14170000901	O O	<b>83165</b>	...		...	...
		141700125243		...	...	O O	<b>85089</b>	...
		141700125275	O O	<b>83165</b>	...		...	...
		20540056	O O	<b>83165</b>	...		...	...
		3031626		...	...	O O	<b>85089</b>	...
		3036162		...	...	O O	<b>85089</b>	...
		3037213	O O	<b>83165</b>	...		...	...
	471700125245			...	...	O O	<b>85089</b>	...
	Autobuses Modelos 7550 y 9700 Eje Tarjeta	131912		...	...	O O	<b>85121</b>	...
		13193027		...	...	O O	<b>85121</b>	...
		481700125768		...	...	O O	<b>85121</b>	...
		481700131912		...	...	O O	<b>85121</b>	...
<b>99 - 05</b>	Volvo 7550 2 y 3 ejes Autobús 4X2	3037213	O O	<b>85094</b>	...		...	...

#### Series VAH

<b>2014</b>	Modelos VAH 430 con Número de E.O.	141700005838	O O	<b>85098</b>	...		...	...
		21436086	O O	<b>85098</b>	...		...	...
	Modelos VAH 430 con Suspensión de Aire Trasera Hendrickson HAS 400 o HAS 460	60675-001		...	...	O O	<b>85978</b>	...
		8083872		...	...	O O	<b>85978</b>	...





#### Series VHD

<b>08 - 11</b>	Modelos con Eje Delantero de 12,000 a 14,600 lb	20433426	O -	<b>85081</b>	...		...	...
		20434880	O -	<b>85081</b>	...		...	...
		471700131258	O -	<b>85081</b>	...		...	...
		SDA471700131258	O -	<b>85081</b>	...		...	...
<b>08 - 11</b>	Modelos con Suspensión Trasera T-Ride	20433427		...	...	O -	<b>85065</b>	...
		471700131256		...	...	O -	<b>85065</b>	...

#### Series VN - 2200

<b>05/99 -</b>	Modelos fabricados después de Mayo 1999	20433425		...	...	O O	<b>85066</b>	<b>89448</b>
		471700002627		...	...	O O	<b>85066</b>	<b>89448</b>
		8086651		...	...	O O	<b>85066</b>	<b>89448</b>
	Modelos con Número de E.O.	20433424	O O	<b>85061</b>	<b>89450</b>		...	...

**GUÍA DE APLICACIONES – CAMIONES, TRÁILERS Y AUTOBUSES**

Año	Modelo	# E.O.	Delantero		Trasero	
						
			Fleetline	GasSLX	Fleetline	GasSLX

**VOLVO (Cont.)**





**Series VN - 2200 (Cont.)**

Modelos con Número de E.O.	20513881	010	<b>85061</b>	<b>89450</b>		...	...
	20551628		...	...	010	<b>85066</b>	<b>89448</b>
	47170000443		...	...	010	<b>85066</b>	<b>89448</b>
	665607		...	...	010	<b>85047</b>	<b>89435</b>
	8077874-P01		...	...	010	<b>85047</b>	<b>89435</b>
	8078195	010	<b>85061</b>	<b>89450</b>		...	...
	8086053		...	...	010	<b>85047</b>	<b>89435</b>
	8169859		...	...	010	<b>85047</b>	<b>89435</b>

**Series VNL**

<b>06 - 14</b>	Modelos 64T-300 o 64T-300U con Hendrickson Airtek	20485633	010	<b>85933</b>	<b>89454</b>		...	...
		21137330	010	<b>85933</b>	<b>89454</b>		...	...
		471700003832	010	<b>85933</b>	<b>89454</b>		...	...
		64838-003	010	<b>85933</b>	<b>89454</b>		...	...
<b>- 13</b>	Modelos 64T-300 o 64T-300U con Número de E.O.	141700005838	010	<b>85098</b>	...		...	...
		21436086	010	<b>85098</b>	...		...	...
<b>2013</b>	Modelos 64T-300 o 64T-300U con Número de E.O.	21462378		...	...	010	<b>85088</b>	...
		471700006038		...	...	010	<b>85088</b>	...
<b>06 - 11</b>	Modelos 64T-300, 64T-300U con Suspensión de Aire Trasera de 40,000 lb	20551628		...	...	010	<b>85066</b>	<b>89448</b>
		471700000443		...	...	010	<b>85066</b>	<b>89448</b>
<b>05 - 14</b>	Modelos 64T-430 con Hendrickson Airtek	20485633	010	<b>85933</b>	<b>89454</b>		...	...
		21137330	010	<b>85933</b>	<b>89454</b>		...	...
		471700003832	010	<b>85933</b>	<b>89454</b>		...	...
		64838-003	010	<b>85933</b>	<b>89454</b>		...	...
<b>12 - 13</b>	Modelos 64T-430 con Número de E.O.	21462380		...	...	010	<b>85088</b>	...
		471700006040		...	...	010	<b>85088</b>	...
<b>05 - 11</b>	Modelos 64T-430 con Suspensión de Aire Trasera de 40,000 lb	20551628		...	...	010	<b>85066</b>	<b>89448</b>
		471700000443		...	...	010	<b>85066</b>	<b>89448</b>
<b>06 - 14</b>	Modelos 64T-630 o 42T-630 con Hendrickson Airtek	20485633	010	<b>85933</b>	<b>89454</b>		...	...
		21137330	010	<b>85933</b>	<b>89454</b>		...	...
		471700003832	010	<b>85933</b>	<b>89454</b>		...	...
		64838-003	010	<b>85933</b>	<b>89454</b>		...	...
<b>06 - 11</b>	Modelos 64T-630, 42T-630 con Suspensión de Aire Trasera de 40,000 lb	20551628		...	...	010	<b>85066</b>	<b>89448</b>
		471700000443		...	...	010	<b>85066</b>	<b>89448</b>
<b>- 14</b>	Modelos 64T-670 con Eje Delantero 13,200 lb	141700005838	010	<b>85098</b>	...		...	...
		21436086	010	<b>85098</b>	...		...	...
<b>06 - 14</b>	Modelos 64T-670 con Hendrickson Airtek	20485633	010	<b>85933</b>	<b>89454</b>		...	...
		21137330	010	<b>85933</b>	<b>89454</b>		...	...
		471700003832	010	<b>85933</b>	<b>89454</b>		...	...
		64838-003	010	<b>85933</b>	<b>89454</b>		...	...
<b>- 14</b>	Modelos 64T-670 con Número de E.O.	21462380		...	...	010	<b>85088</b>	...
<b>06 - 11</b>	Modelos 64T-670 con Suspensión de Aire Trasera de 40,000 lb	20551628		...	...	010	<b>85066</b>	<b>89448</b>
		471700000443		...	...	010	<b>85066</b>	<b>89448</b>
<b>06 - 14</b>	Modelos 64T-730 o 64T-730U con Hendrickson Airtek	20485633	010	<b>85933</b>	<b>89454</b>		...	...
		21137330	010	<b>85933</b>	<b>89454</b>		...	...
		471700003832	010	<b>85933</b>	<b>89454</b>		...	...
		64838-003	010	<b>85933</b>	<b>89454</b>		...	...
<b>06 - 11</b>	Modelos 64T-730, 64T-730U con Suspensión de Aire Trasera de 40,000 lb	20551628		...	...	010	<b>85066</b>	<b>89448</b>
		471700000443		...	...	010	<b>85066</b>	<b>89448</b>
<b>- 14</b>	Modelos 64T-780 con Eje Delantero 13,200 lb	141700005838	010	<b>85098</b>	...		...	...
		21436086	010	<b>85098</b>	...		...	...
<b>06 - 14</b>	Modelos 64T-780 con Hendrickson Airtek	20485633	010	<b>85933</b>	<b>89454</b>		...	...
		21137330	010	<b>85933</b>	<b>89454</b>		...	...
		471700003832	010	<b>85933</b>	<b>89454</b>		...	...

**GUÍA DE APLICACIONES – CAMIONES, TRÁILERS Y AUTOBUSES**

Año	Modelo	# E.O.	Delantero		Trasero	
						
			Fleetline	GasSLX	Fleetline	GasSLX

**VOLVO (Cont.)**

**Series VNL (Cont.)**

06 - 14	Modelos 64T-780 con Hendrickson Airtek	64838-003	010	85933	89454		...	...
12 - 14	Modelos 64T-780 con Número de E.O.	21462380		...	...	010	85088	...
		471700006040		...	...	010	85088	...
06 - 11	Modelos 64T-780 con Suspensión de Aire Trasera de 40,000 lb	20551628		...	...	010	85066	89448
		471700000443		...	...	010	85066	89448
06 - 09	Modelos 64T-830 con Suspensión de Aire Hendrickson Primaax EX y FireMaax EX de 40,000 lb	20782199		...	...	010	85072	...
06 - 09	Modelos 64T-830 con Suspensión de Aire Hendrickson Primaax, Primaax EX y FireMaax EX de 40,000 lb	60657-007		...	...	010	85072	...
05/99 -	Modelos con Suspensión de Aire Trasera de 38,000 lb fabricada después de Mayo 1999	20433425		...	...	010	85066	89448
		471700002627		...	...	010	85066	89448
06 - 10	Todos los Modelos con Ejes Delanteros 12,000 - 13,200 lb	20433424	010	85061	89450		...	...

**Series VNM**

- 14	Modelos 64T-200 con Número de E.O.	21436086	010	85098	...		...	...
		21436086	010	85098	...		...	...
- 14	Modelos 64T-430 con Eje Delantero 12,000 lb	21436086	010	85098	...		...	...
- 14	Modelos 64T-630 con Eje Delantero 12,000 lb	21436086	010	85098	...		...	...
- 14	Modelos con Número de E.O.	21462378		...	...	010	85088	...
		21462380		...	...	010	85088	...

**Series VT**

06 - 09	Modelos 64T-830 con Suspensión de Aire Hendrickson Primaax, Primaax EX y FireMaax EX de 40,000 lb	60657-007		...	...	010	85072	...
06 - 10	Modelos 64T-830 con Suspensión de Aire Trasera de 40,000 lb	20551628		...	...	010	85066	89448
		471700000443		...	...	010	85066	89448
06 - 09	Modelos 64T-880 con Suspensión de Aire Hendrickson Primaax EX y FireMaax EX de 40,000 lb	20782199		...	...	010	85072	...
06 - 10	Todos los Modelos con Ejes Delanteros 12,000 - 13,200 lb	20433424	010	85061	89450		...	...

**Series WCA & WIA**

	Modelos con Amortiguadores Delanteros Duales	02-7005976	- -	83400	...		...	...
		3082284	- -	83400	...		...	...
- 92	Modelos con Número de E.O. y hasta el No. de Serie 657250	8071524		...	...	010	85024	89416
93 - 95	Modelos con Número de E.O. y posterior al No. de Serie 657841	8026658		...	...	010	85046	89434
95 -	Todos con Número de E.O. y posterior al Número de Serie (VIN) 723506	8169859		...	...	010	85047	89435
	Modelos con Número de E.O.	37301-0016	01-	85026	89417		...	...
		37301-0021	01-	85026	89417		...	...
		37301-3201	- -	85027	89418		...	...
		37301-3202	01-	85026	89417		...	...
		4975549	010	83216	...		...	...
		8065787	01-	85026	89417		...	...



**Series WG**

	Modelos con Número de E.O.	35901-3201		...	...	010	85024	89416
		37301-3201	- -	85027	89418		...	...
		665623		...	...	010	85046	89434
- 92	Modelos con Número de E.O.	8065787	01-	85026	89417		...	...
		8071524		...	...	010	85024	89416
93 - 95	Modelos con Número de E.O.	8026658		...	...	010	85046	89434

**Series WH**

	Modelos WHS, WHR, WHL o WHE con Amortiguadores Delanteros Duales	02-7005976	- -	83400	...		...	...
		3082284	- -	83400	...		...	...
	Modelos WHS, WHR, WHL o WHE con Amortiguadores Delanteros Sencillos	37301-0021	01-	85026	89417		...	...
- 92	Modelos WHS, WHR, WHL o WHE con Número de E.O.	35901-3201		...	...	010	85024	89416
		8071524		...	...	010	85024	89416

**GUÍA DE APLICACIONES – CAMIONES, TRÁILERS Y AUTOBUSES**

Año	Modelo	# E.O.	Delantero		Trasero	
						
			Fleetline	GasSLX	Fleetline	GasSLX

**VOLVO (Cont.)**

**Series WH (Cont.)**

<b>93 - 95</b>	Modelos WHS, WHR, WHL o WHE con Número de E.O.	8026658	...	...	010	<b>85046</b>	<b>89434</b>
<b>95 -</b>	Modelos WHS, WHR, WHL o WHE con Número de E.O.	8169859	...	...	010	<b>85047</b>	<b>89435</b>





**Aplicaciones Adicionales**

	Modelos 1500	....	010	<b>83122 or 89406</b>				
	Modelos 1500							
	Modelos con Suspensión Trasera	35901-0005		...	...	010	<b>83219</b>	...
	Modelos con Suspensión Velvet	530596		...	...	010	<b>85308</b>	<b>89422</b>
	Modelos 3000, 4000 & 9000 - Unidad Especial - 4 Amortiguadores por Eje	5554959	010	<b>83401</b>	...		...	...
		676081	010	<b>83401</b>	...		...	...
		676082	010	<b>83401</b>	...		...	...
	Modelos 3014, 3015, 3016, 3020 C.O.E. y 1500	....	010	<b>83122</b>	<b>89406</b>		...	...
	Modelos 9000	....	010	<b>83122</b>	<b>89406</b>		...	...
	Modelos Brigadier	22012065	010	<b>85304</b>	...		...	...
		22046483	010	<b>85304</b>	...		...	...
		22052336	010	<b>85304</b>	...		...	...
<b>78 - 83</b>	RC2	....		...	...	010	<b>83122</b>	<b>89406</b>
	Road Boss, Road Boss II, Road Commander II, Road Expeditor - (4 Amortiguadores por Eje)	3946210	-1-	<b>83103</b>	...		...	...
	Road Boss, Road Boss II, Road Commander, Road Commander II, Road Expeditor II - (4 Amortiguadores por Eje)	02-7005976	-1-	<b>83400</b>	...		...	...
		02-7005977	-1-	<b>83400</b>	...		...	...
		4975479	-1-	<b>83400</b>	...		...	...
		4975480	-1-	<b>83400</b>	...		...	...
<b>03 - 05</b>	Autobús Volvo 9700	70321695	01φ	<b>85381</b>	...		...	...
	Autobús Volvo 9701 Modelos TXB12B de Tránsito	48170000801	01φ	<b>85381</b>	...		...	...
	Modelos con Número de E.O.	35901-0001		...	...	010	<b>83209</b>	<b>89414</b>
		35901-0008		...	...	010	<b>85060</b>	...
		37301-0008	-1-	<b>83400</b>	...		...	...
		60675-001		...	...	010	<b>85978</b>	...
		665410	-1-	<b>85027</b>	<b>89418</b>		...	...
		665539	01-	<b>85026</b>	<b>89417</b>		...	...
		665739		...	...	010	<b>85047</b>	<b>89435</b>
		70042	010	<b>85302</b>	<b>89420</b>		...	...
		8075287		...	...	01-	<b>85065</b>	...
		8083872		...	...	010	<b>85978</b>	...
		8169859		...	...	010	<b>85047</b>	<b>89435</b>
		8174749		...	...	010	<b>85906</b>	<b>89407</b>
	Modelos con Suspensión Hendrickson AirTek	471700131920	010	<b>85933</b>	<b>89454</b>		...	...
		471700131921	010	<b>85933</b>	<b>89454</b>		...	...
		64838-001	010	<b>85933</b>	<b>89454</b>		...	...
		64838-002	010	<b>85933</b>	<b>89454</b>		...	...

**Intercambios Adicionales de E.O.**

	Intercambios Adicionales de E.O.	03-1106460	010	<b>85005 or 89430</b>			
		20863239	01-	<b>85080</b>			
		35901-0003	010	<b>85301</b>			
		35901-0004	010	<b>83219</b>			
		35901-0011	010	<b>83123 or 89405</b>			
		35901-0017	010	<b>83314</b>			
		35901-0022	01-	<b>83635</b>			
		35901-3406	010	<b>85305</b>			
		35901-3409	010	<b>85304</b>			
		35901-3410	010	<b>85307</b>			
		35901-3413	010	<b>85006</b>			
		35901-3420	010	<b>85303 or 89422</b>			

**GUÍA DE APLICACIONES – CAMIONES, TRÁILERS Y AUTOBUSES**



Año	Modelo	# E.O.	Delantero		Trasero	
						
			Fleetline	GasSLX	Fleetline	GasSLX

**VOLVO (Cont.)**

**Intercambios Adicionales de E.O. (Cont.)**

Intercambios Adicionales de E.O.	37001-5	010	83401				
	37301-0001	010	85013 or 89414				
	37301-0018	010	85005 or 89430				
	3953643	010	85040				
	4940640	010	83216				
	494-660	010	83219				
	5322338	010	83214				
	5513989	010	83216				
	5531435	010	85307				
	5531436	010	85307				
	5531437	010	85307				
	5534430	010	85303 or 89422				
	5534447	010	85303 or 89422				
	5549899	010	83207 or 89407				
	5549925	010	85304				
	629398	010	85307				
	629501	010	85307				
	646220	010	85734				
	66010-0016	01-	85025				
	668302	010	83216				
6771501	010	85040					
6775411	010	85040					
Modelos con Número de E.O.	141700000373	010	85061	89450		...	...
	3092842	010	85061	89450		...	...
	3919958		...	...	010	85046	89434
	3949241	010	85061	89450		...	...
	3972662		...	...	010	85976	...
Intercambios Adicionales de E.O.	1091347	010	83125				
	1091348	010	83122 or 89406				
	1091349	010	83204				
	1091350	010	83207 or 89407				
	1091351	010	83209 or 89414				
	1091353	010	83215				
	1091354	010	83216				
	1091355	010	83217				
	1091357	010	83219				
	1091358	-1-	83456 or 89447				
	1091359	010	83123 or 89405				
	1091360	010	83303				
	1091361	010	83304				
	1091362	010	83309 or 89446				
	1091363	010	83221				
	1091364	010	83312 or 89409				
	1091365	-1-	83400				
	1091366	010	83401				
	1091367	010	85000 or 89436				
	1091368	010	85003 or 89411				
	1091370	010	85006				
	1091371	010	85300 or 89419				
	1091372	010	85301				
	1091373	010	85302 or 89420				
	1091374	010	85303 or 89422				
	1091375	010	85304				
	1091376	010	85305				
1091377	010	85307					

**GUÍA DE APLICACIONES – CAMIONES, TRÁILERS Y AUTOBUSES**

Año	Modelo	# E.O.	Delantero		Trasero	
						
			Fleetline	GasSLX	Fleetline	GasSLX





**VOLVO (Cont.)**

**Intercambios Adicionales de E.O. (Cont.)**

Intercambios Adicionales de E.O.	1091378	010	85308 or 89422
	1091379	-1-	85310 or 89423
	1091384	010	85735
	1093100	-1-	85027 or 89418
	1093174	01-	83353
	1093176	010	85024 or 89416
	1093177	01-	85025
	1093178	01-	85026 or 89417
	1093180	010	85030 or 89440
	1716824	010	85304
	3130140	010	85315
	3171696	010	85307
	3172948	010	85303 or 89422
	3199937	-10	85316 or 89426
	3199938	010	85030 or 89432
	3199939	010	85058 or 89431
	3199940	010	85005 or 89430
	3199941	010	85006
	3199942	010	89402
	3199943	010	85012 or 89413
	3199944	010	85006
	3199945	-1-	85027 or 89418
	3199946	-10	85033 or 89427
	3199947	010	85013 or 89414
	3199948	-10	85311 or 89424
	3199949	-1-	85310 or 89423
	3199950	010	85023 or 89415
	3199951	010	85024 or 89416
	3199952	010	85736
	3199953	-10	85319 or 89428
	3199954	010	85003 or 89411
	3199955	010	85300 or 89419
	3199956	010	85036 or 89405
	3199957	010	83122 or 89406
	3199959	010	85323 or 89436
	3199960	010	85322
	3199961	010	85307
	3199962	010	85314 or 89425
	3199963	010	85315
	3199965	010	85736
	3199966	010	85303 or 89422
	3199967	010	85302 or 89420
	3199968	010	85308 or 89422
	3199970	-1-	85701
	3199972	010	85320 or 89429
	3199973	-1-	85722
	3199974	010	85712
	3199975	010	85700
3199976	-10	85711	
3199977	-10	85711	
3199978	010	85712	
3199979	010	85702	
3199980	-1-	85310 or 89423	
3199982	-10	85703	
3199983	010	85704	



**GUÍA DE APLICACIONES – CAMIONES, TRÁILERS Y AUTOBUSES**





Año	Modelo	# E.O.	Delantero		Trasero	
						
			Fleetline	GasSLX	Fleetline	GasSLX

**VOLVO (Cont.)**

**Intercambios Adicionales de E.O. (Cont.)**

Intercambios Adicionales de E.O.	3199984	010	85314 or 89425
	3199985	01-	85723
	3199986	-1-	85318
	3199987	-1-	85705
	3199988	-10	85311 or 89424
	3199989	-1-	85709
	3199990	010	85003 or 89411
	3199991	-1-	85708
	3199992	01-	85733
	3199993	010	85712
	3199994	010	85308 or 89422
	3915917	-10	85319 or 89428
	3915947	010	85001 or 89410
	3915948	-10	85311 or 89424
	3916352	010	85013 or 89414
	3919055	010	85007 or 89412
	3919056	010	83203 or 89436
	3919057	010	83225
	3919526	010	83314
	3919561	010	85314 or 89425
	3919565	-1-	83103
	3919567	-1-	83613
	3919568	010	83636
	3919569	010	85052
	3919570	010	83128
	3919571	01-	83635
	3919572	010	83130
	3919573	010	83123 or 89405
	3919574	010	85006 or 89401
	3919575	01-	83120
	3919582	010	83215
	3919583	010	83100
	3919584	01-	83353
	3919585	010	83209 or 89414
	3919586	010	83100
	3919587	-10	83105
	3919588	010	83216
	3919589	01-	85026 or 89417
	3919590	010	85042
	3919591	-10	G63616
3919592	010	85024 or 89416	
3919593	010	83242	
3919594	010	85003 or 89411	
3919596	01-	G63484	
3919598	010	83312 or 89409	
3919900	010	85012 or 89413	
3919901	-1-	83103	
3919902	010	83126 or 89430	
3919903	010	83216	
3919904	010	G63183	
3919906	010	83308	
3919907	010	83309 or 89446	
3919908	010	83104	
3919909	010	G63605	
3919910	010	83221	

**GUÍA DE APLICACIONES – CAMIONES, TRÁILERS Y AUTOBUSES**





Año	Modelo	# E.O.	Delantero		Trasero	
						
			Fleetline	GasSLX	Fleetline	GasSLX

**VOLVO (Cont.)**

**Intercambios Adicionales de E.O. (Cont.)**

Intercambios Adicionales de E.O.	3919911	010	83124 or 89407
	3919912	010	83215
	3919913	010	83203 or 89436
	3919914	010	83209 or 89414
	3919915	010	83127
	3919916	010	83126 or 89430
	3919917	010	83125
	3919918	010	83401
	3919919	010	G63625
	3919920	010	83303
	3919921	010	83123 or 89405
	3919922	-1-	83318
	3919923	-10	83301
	3919924	-1-	83456 or 89447
	3919925	-10	83317
	3919926	010	G63403
	3919927	010	83101
	3919928	010	83225
	3919930	01-	83353
	3919931	010	83126 or 89430
	3919932	010	85062 or 89408
	3919933	010	85001 or 89410
	3919934	010	85320 or 89429
	3919935	01-	85026 or 89417
	3919936	010	83207 or 89407
	3919937	-10	85316 or 89426
	3919938	010	85030 or 89432
	3919939	010	85058 or 89431
	3919940	010	85005 or 89430
	3919941	010	85006
	3919942	010	89402
	3919943	010	85012 or 89413
	3919944	010	85036
	3919945	-1-	85027 or 89418
	3919946	-10	85033 or 89427
	3919947	010	85013 or 89414
	3919948	-10	85311 or 89424
	3919949	-1-	85310 or 89423
	3919950	010	83219
	3919951	010	83309 or 89416
	3919952	010	85736
	3919953	-10	85319 or 89428
	3919954	010	85003 or 89411
	3919955	010	85300 or 89419
	3919956	010	85036 or 89405
	3919957	010	83122 or 89406
3919959	010	85000 or 89436	
3919960	010	85322	
3919961	010	85302 or 89420	
3919962	010	85700	
3919963	010	85730	
3919964	010	85716	
3919964	010	85304	
3919965	010	85702	
3919966	010	85736	

## GUÍA DE APLICACIONES – CAMIONES, TRÁILERS Y AUTOBUSES

Año	Modelo	# E.O.	Delantero		Trasero	
						
			Fleetline	GasSLX	Fleetline	GasSLX

### VOLVO (Cont.)





#### Intercambios Adicionales de E.O. (Cont.)

Intercambios Adicionales de E.O.	3919967	010	85302 or 89420
	3919968	010	85736
	3919970	-1-	85701
	3919972	010	85320 or 89429
	3919973	010	85956
	3919974	010	85712
	3919975	010	85700
	3919976	-10	85033 or 89427
	3919977	-10	85033 or 89427
	3919978	010	85702
	3919979	010	85702
	3919980	010	85702
	3919981	-1-	85701
	3919982	-10	85703
	3919983	010	85704
	3919984	010	85700
	3919985	01-	85723
	3919987	-1-	85706
	3919988	-10	85311 or 89424
	3919989	-1-	85709
	3919990	010	85003 or 89411
	3919991	-1-	85708
	3919992	01-	85733
	3919993	010	85712
	3919994	-1-	85310 or 89423
	3945806	01-	89417
	3945807	010	89416
	3945808	010	89407
	3945809	010	89410
	3945810	010	89420
	3945811	010	89409
	3945812	-1-	89423
	3945813	-10	89428
	3945814	-10	89424
	3945815	010	89406
3945816	010	89430	
3945817	010	89422	
3945818	010	89415	
3945819	010	89411	
3945820	010	89413	
3945821	010	89419	
3946219	-1-	83400	

#### VOLVO AMORTIGUADORES DE CABINA

	Modelo Link Cabmate WRC-2P	1202-0032	010	83016
	Modelos Aero (Modelos WCA o WIA)	66010-0007	010	83004
		66010-0008	010	83004
		8162662	010	83004
	Modelos con Número de E.O.	20874147	01-	83050
		635869	010	83004
		8168617	010	83030
	Modelos con Suspensión Link Cab	1202-0022	010	83046
<b>2014 -</b>	Modelos VAH 430 con Dormitorios de 42"	20721254	010	83048
<b>08 - 09</b>	Modelos VHD con Número de E.O.	20704334	010	83048

**GUÍA DE APLICACIONES – CAMIONES, TRÁILERS Y AUTOBUSES**

Año	Modelo	# E.O.	Delantero		Trasero	
						
			Fleetline	GasSLX	Fleetline	GasSLX

**VOLVO AMORTIGUADORES DE CABINA (Cont.)**

- 14	Modelos VNL - Modelos 64T-670 y 64T-780 con Cabinas Dormitorio de Alta Elevación	21368413	010	<b>83048</b>
06 - 10	Modelos VNL - Todos con Dormitorios de Techo Medio - Alto de 60" a 77" (con Número de E.O.)	20721254	010	<b>83048</b>
2013	Modelos VNL- 64T-430 con Número de E.O.	21391412	010	<b>83048</b>
		21391412	010	<b>83048</b>
- 14	Modelos VNM - Todos con Dormitorios de Techo Medio - Alto de 60" a 77" (con Número de E.O.)	21391412	010	<b>83048</b>
06 - 10	Modelos VT - Todos con Dormitorios de Techo Medio - Alto de 60" a 77" (con Número de E.O.)	20721254	010	<b>83048</b>
	Tractos Convencionales WG con Cabinas de 112" con Modelo Link Cabmate WWG112-A	1201-0012	010	<b>83023</b>
		1202-0012	010	<b>83023</b>









**Series VN - 2200**

	Modelos VN - Posición Horizontal	20496217	010	<b>83029</b>
		8078547	010	<b>83029</b>
	Modelos VN - Posición Vertical (con Número de E.O.)	20496215	010	<b>83048</b>
		20704334	010	<b>83048</b>
		20721254	010	<b>83048</b>
		21368413	010	<b>83048</b>
		8078546	010	<b>83028</b>

**WABASH NATIONAL**

Es necesaria la identificación de la suspensión para determinar qué sección del catálogo referir. Posibles opciones pueden ser Chalmers, Hendrickson, Neway, Ridewell, Reyco.							
97 -	Suspensión de Tráiler RHP11, RHP55 y RideSentry	202447	...	...	010	<b>85919</b>	...
		203447	...	...	010	<b>85919</b>	...
	Tráilers con número de parte Aurora	DANSR1VJ100	...	...	010	<b>85078</b>	...
		FLL83203-071	...	...	010	<b>83203</b>	<b>89436</b>
		FLL83207-071	...	...	010	<b>83207</b>	<b>89407</b>
		FLL85000-071	...	...	010	<b>85000</b>	<b>89436</b>
		FLL85030-071	...	...	010	<b>85030</b>	<b>89440</b>
		FRUUCE1295-1	...	...	010	<b>85300</b>	<b>89419</b>
		FRUUCE1295-901	...	...	010	<b>85300</b>	<b>89419</b>
		FRUUCE2983-1	...	...	010	<b>85322</b>	...
		FRUUCF8339-1	...	...	010	<b>85321</b>	...
		HENS-20001	...	...	010	<b>83128</b>	<b>89436</b>
		HENS-20002	...	...	010	<b>85000</b>	<b>89436</b>
		HENS-20126	...	...	010	<b>85323</b>	<b>89436</b>
		HENS-21292	...	...	010	<b>85052</b>	...
		HENS-23566	...	...	010	<b>85000</b>	<b>89436</b>
		HENS-24088	...	...	010	<b>85000</b>	<b>89436</b>
		NEW900-44-089	...	...	010	<b>83124</b>	<b>89407</b>
		NEW900-44-162	...	...	010	<b>83128</b>	<b>89436</b>
		NEW900-44-625	...	...	010	<b>83125</b>	...
		NEW900-44-626	...	...	010	<b>83126</b>	<b>89430</b>
		NEW900-44-642	...	...	010	<b>83127</b>	...
		NEW900-44-794	...	...	010	<b>83127</b>	...
		NEW900-44-868	...	...	010	<b>85045</b>	...
		NEW900-44-978	...	...	010	<b>85059</b>	...
		NEW900-44-979	...	...	010	<b>83113</b>	...
		NEW900-45-040	...	...	010	<b>83130</b>	...
		NEW900-45-054	...	...	010	<b>85051</b>	...
		NEW900-45-298	...	...	010	<b>83128</b>	...
		NEW900-45-299	...	...	010	<b>85000</b>	<b>89436</b>

**GUÍA DE APLICACIONES – CAMIONES, TRÁILERS Y AUTOBUSES**

Año	Modelo	# E.O.	Delantero		Trasero	
						
						
			Fleetline	GasSLX	Fleetline	GasSLX

**WATSON & CHALIN MFG. INC.**

**Series WCAL 2200 - Eje Tarjeta**

	Modelos AL-2200	10148		...	...	010	83204	...
--	-----------------	-------	--	-----	-----	-----	-------	-----

**Series WCTA - Suspensión de Aire para Tráiler**

	TA-2075-6	10148		...	...	010	83204	...
	TA-2075-9	12128		...	...	010	85005	89430
	TA-250-12	10148		...	...	010	83204	...
	TA-250-6, 7.5, 9,	10147		...	...	010	83203	89436
	TA-251-12, -12FS,	10148		...	...	010	83204	...
	TA-251-6.5, -6.5FS,	10147		...	...	010	83203	89436
	TA-251-7.5, -7.5FS	10147		...	...	010	83203	89436
	TA-251-8FS	10147		...	...	010	83203	89436
	TA-251-9.0, -9.0FS, -10,	10147		...	...	010	83203	89436
	TA-255-9	10147		...	...	010	83203	89436
	TA-280-6.5, 7.5, -9.0,	11604		...	...	010	83125	...
	TA-300-9	10147		...	...	010	83203	89436
	TA-380-9	12128		...	...	010	85005	89430

**Series WCTA - Suspensión de Aire para Tráiler de Volteo**

	TA-1600-21	11604		...	...	010	83125	...
	TA-1900-15	10147		...	...	010	83203	89436
	TA-1900-16, -17	10148		...	...	010	83204	...
	TA-1900-18, -19	12128		...	...	010	85005	89430
	TA-5000-DB-19, -F-19	12128		...	...	010	85005	89430
	TA-5000-DB-24, -DB-30, -F-24, -F-30,	11724		...	...	010	83123	89405
	TA-525, -DB	10147		...	...	010	83203	89436

**Series WCWB - Suspensión de Aire para Tráiler**

	WB-2500-6	10148		...	...	010	83204	...
	WB-2500-7.5, -9,	12128		...	...	010	85005	89430
	WB-251-6.5, 7.5, 9	10147		...	...	010	83203	89436
	WB-280-9	11604		...	...	010	83125	...
	Modelos con Número de E.O.	17300		...	...	010	85052	...
		3946219		...	...	11	83400	...
		665727		...	...	010	85005	89430
		665769		...	...	010	85052	...

**Suspensión de Aire para Tráiler**

	TA-2590-12, 14, 15, & 17,	12128		...	...	010	85005	89430
	TA-2590-12-1	10147		...	...	010	83203	89436

**Suspensión de Aire para Tráiler Heavy Duty**

	TA-2590-14, 17 HD	10148		...	...	010	83204	...
	TA-3090-14, -17, -19	10148		...	...	010	83204	...
	TA-550-17	10148		...	...	010	83204	...

**Suspensión de Aire para Tráiler Light Weight**

	TA-3175-9	17079		...	...	010	85300	89419
	TA-751-16	10148		...	...	010	83204	...

**Suspensión de Eje con Auto Dirección LWSL-1100-SR**

	HL-1100-20	10148		...	...	010	83204	...
	HL-1100-20 FL	10147		...	...	010	83203	89436
	Modelos AL-1100-SR	10148		...	...	010	83204	...
	SL-1100-LR	12128		...	...	010	85005	89430





**WCTA - Series 1200 - Suspensión de Aire para Tráiler**

	TA-1000	10634		...	...	010	G63357	...
	TA-1200-5	10147		...	...	010	83203	89436

**WCTL - Series 2200 - Suspensión de Aire Eje Levantado**

	TL-1600-21	11604		...	...	010	83125	...
10/89 -	TL-2590-12,14,15, & 17	12128		...	...	010	85005	89430

**GUÍA DE APLICACIONES – CAMIONES, TRÁILERS Y AUTOBUSES**

Año	Modelo	# E.O.	Delantero		Trasero	
						
			Fleetline	GasSLX	Fleetline	GasSLX

**WATSON & CHALIN MFG. INC. (Cont.)**

**Intercambios Adicionales de E.O. (Cont.)**

Modelos con Número de E.O.	10147HD	...	...	010	<b>85000</b>	89436
	17186	...	...	010	<b>85323</b>	89436
	17186-01	...	...	010	<b>85323</b>	89436
	17218	...	...	010	<b>85029</b>	...
	17297	...	...	010	<b>85064</b>	...
	17306	...	...	010	<b>85938</b>	...
	17317	...	...	010	<b>85344</b>	...
	17382	...	...	010	<b>85014</b>	...
	17430	...	...	010	<b>85321</b>	...
	17474	...	...	010	<b>85009</b>	...
	19036	...	...	010	<b>85934</b>	...
	19603	...	...	010	<b>85939</b>	...
	665724	...	...	010	<b>85000</b>	89436
	665728	...	...	010	<b>85060</b>	...
	665770	...	...	010	<b>85064</b>	...
	665862	...	...	010	<b>85000</b>	89436
	680547	...	...	010	<b>85323</b>	89436
	680584	...	...	010	<b>85938</b>	...
	680714	...	...	010	<b>85934</b>	...
	727603	...	...	010	<b>83203</b>	89436
	727604	...	...	010	<b>83204</b>	...

**WESTERN STAR**

**Series 3800 - Heritage Class**

con Suspensión Trasera Hendrickson	47902-13	...	...	010	<b>83122</b>	89406
	47902-24	...	...	010	<b>83121</b>	...
	47902-8	...	...	010	<b>83122</b>	89406
con Suspensión Trasera Neway	90044025	...	...	010	<b>83209</b>	89414
	90044907	...	...	01-	<b>83635</b>	...
Modelos 3842S, 3864S	37390-4401	010	<b>85053</b>	89442	...	...
	37390-4402	010	<b>85053</b>	89442	...	...
	37390-4403	010	<b>85053</b>	89442	...	...









**Series 4700**

<b>11 - 15</b>	Modelos con Eje Delantero con Desplazamiento hacia Atrás de 20000 lb	10-13809-000	010	<b>85958</b>	...	...
<b>11 - 15</b>	Modelos con Suspensión de Aire Trasera FAS II	16-18708-000	...	...	010	<b>85724</b> 89443

**Series 4800 & 4900 - Constellation Class**

4842FX, 4864FX, 4964EX, 4964EX, 4942SX o 4964SX Constellation Class	37301-3401	010	<b>85053</b>	89442	...	...
	37301-3404	010	<b>85053</b>	89442	...	...
	37301-3409	010	<b>85053</b>	89442	...	...
	37301-3412	010	<b>85053</b>	89442	...	...
	37390-4401	010	<b>85053</b>	89442	...	...
	37390-4402	010	<b>85053</b>	89442	...	...
	37390-4403	010	<b>85053</b>	89442	...	...
con Suspensión Trasera Hendrickson	47902-13	...	...	010	<b>83122</b>	89406
	47902-24	...	...	010	<b>83121</b>	...
	47902-8	...	...	010	<b>83122</b>	89406
con Suspensión Trasera Hendrickson HAS-40LH	57241-1	...	...	01-	<b>83111</b>	...
con Suspensión Trasera Neway	90044025	...	...	010	<b>83209</b>	89414
	90044907	...	...	01-	<b>83635</b>	...
	90045099	...	...	010	<b>85906</b>	89407
<b>09 - 12</b>	Modelos con Suspensión de Aire Trasera de Perfil Bajo	16-18706-000	...	...	010	<b>85331</b> ...
<b>08 - 10</b>	Modelos con Suspensión de Aire Trasera TufTrac Freightliner	SDA481700125969	...	...	010	<b>85956</b> ...
<b>08 - 15</b>	Modelos con Suspensión de Aire Trasera TufTrac Freightliner	16-15770-000	...	...	010	<b>85956</b> ...

## GUÍA DE APLICACIONES – CAMIONES, TRÁILERS Y AUTOBUSES

Año	Modelo	# E.O.	Delantero		Trasero	
						
						
			Fleetline	GasSLX	Fleetline	GasSLX

### WESTERN STAR (Cont.)

#### Series 4800 & 4900 - Constellation Class (Cont.)

09 - 15	Modelos con Suspensión Delantera de Muelles de 12000 lb	10-13809-000 SDA471700003920	OIO	85958	...	...	...
			OIO	85958	...	...	...

#### Series 4800 & 4900 - Heritage Class

	4842F, 4864F, 4843S, 4864S, 4942F, 4964F, 4942S o 4964S Heritage Class	37301-3401	OIO	85053	89442		...	...
		37301-3404	OIO	85053	89442		...	...
		37301-3409	OIO	85053	89442		...	...
		37301-3412	OIO	85053	89442		...	...
		37390-4401	OIO	85053	89442		...	...
		37390-4402	OIO	85053	89442		...	...
	con Suspensión Trasera Hendrickson	47902-13		...	...	OIO	83122	89406
		47902-24		...	...	OIO	83121	...
		47902-8		...	...	OIO	83122	89406
	con Suspensión Trasera Hendrickson HAS-40LH	57241-1		...	...	OI-	83111	...
	con Suspensión Trasera Neway	90044025		...	...	OIO	83209	89414
		90044907		...	...	OI-	83635	...
		90045099		...	...	OIO	85906	89407
08 - 10	Modelos con Suspensión de Aire Trasera TufTrac Freightliner	SDA481700125969		...	...	OIO	85956	...
08 - 15	Modelos con Suspensión de Aire Trasera TufTrac Freightliner	16-15770-000		...	...	OIO	85956	...
09 - 15	Modelos con Suspensión Delantera de Muelles de 12000 lb	10-13809-000	OIO	85958	...		...	...
		SDA471700003920	OIO	85958	...		...	...





#### Series 5800 & 5900 - Constellation Class

	5842SS, 5864SS, 5942SS o 5964SS Constellation Class	37301-3401	OIO	85053	89442		...	...
		37301-3404	OIO	85053	89442		...	...
		37301-3409	OIO	85053	89442		...	...
		37301-3412	OIO	85053	89442		...	...
		37390-4401	OIO	85053	89442		...	...
		37390-4402	OIO	85053	89442		...	...
	con Suspensión Trasera Hendrickson	47902-13		...	...	OIO	83122	89406
		47902-24		...	...	OIO	83121	...
		47902-8		...	...	OIO	83122	89406
	con Suspensión Trasera Neway	90044025		...	...	OIO	83209	89414
		90044907		...	...	OI-	83635	...
		90045099		...	...	OIO	85906	89407
				...	...	OIO	85956	...
08 - 10	Modelos con Suspensión de Aire Trasera TufTrac Freightliner	SDA481700125969		...	...	OIO	85956	...
08 - 15	Modelos con Suspensión de Aire Trasera TufTrac Freightliner	16-15770-000		...	...	OIO	85956	...
09 - 15	Modelos con Suspensión Delantera de Muelles de 12000 lb	10-13809-000	OIO	85958	...		...	...
		SDA471700003920	OIO	85958	...		...	...
	Modelos con Número de E.O.	57905-2		...	...	OIO	85006	...

#### Series 5900 & 6900 - Heritage Class

	5942S, 5964S, 6964F o 6964S Heritage Class	37301-3401	OIO	85053	89442		...	...
		37301-3404	OIO	85053	89442		...	...
		37301-3409	OIO	85053	89442		...	...
		37301-3412	OIO	85053	89442		...	...
		37390-4401	OIO	85053	89442		...	...
		37390-4402	OIO	85053	89442		...	...
	con Suspensión Trasera Hendrickson	47902-13		...	...	OIO	83122	89406
		47902-24		...	...	OIO	83121	...
		47902-8		...	...	OIO	83122	89406
		60675-002		...	...	OIO	85979	...
	con Suspensión Trasera Hendrickson HAS-40LH	57241-1		...	...	OI-	83111	...
	con Suspensión Trasera Neway	90044025		...	...	OIO	83209	89414

**GUÍA DE APLICACIONES – CAMIONES, TRÁILERS Y AUTOBUSES**

Año	Modelo	# E.O.	Delantero		Trasero	
						
			Fleetline	GasSLX	Fleetline	GasSLX

**WESTERN STAR (Cont.)**

**Series 5900 & 6900 - Heritage Class (Cont.)**

	con Suspensión Trasera Neway	90044907 90045099		...	...	01-	<b>83635</b>	...
				...	...	010	<b>85906</b>	<b>89407</b>
<b>08 - 10</b>	Modelos con Suspensión de Aire Trasera TufTrac Freightliner	SDA481700125969		...	...	010	<b>85956</b>	...
<b>08 - 15</b>	Modelos con Suspensión de Aire Trasera TufTrac Freightliner	16-15770-000		...	...	010	<b>85956</b>	...
<b>09 - 15</b>	Modelos con Suspensión Delantera de Muelles de 12000 lb	10-13809-000	010	<b>85958</b>	...		...	...
		SDA471700003920	010	<b>85958</b>	...		...	...
<b>- 06/10</b>	Modelos con Suspensión Hendrickson AirTek	58913-003	010	<b>85932</b>	<b>89453</b>		...	...
<b>07/10 -</b>	Modelos con Suspensión Hendrickson AirTek	471700006269	010	<b>85932</b>	<b>89453</b>		...	...
		58913-012	010	<b>85932</b>	<b>89453</b>		...	...
	Todos con Sistema Delantero de 4 Amortiguadores	.....	010	<b>83401</b>	...		...	...
	Modelos con Número de E.O.	02-7005976	-1-	<b>83400</b>	...		...	...
		02-7005977	-1-	<b>83400</b>	...		...	...
		04-9041375		...	...	010	<b>85315</b>	...
		28R010		010	<b>83216</b>	...		...
		35066-4413		...	...	010	<b>83122</b>	<b>89406</b>
		35901-0001		...	...	010	<b>83209</b>	<b>89414</b>
		35901-4403		...	...	010	<b>85060</b>	...
		37301-3405		010	<b>85053</b>	<b>89442</b>		...
		57252		010	<b>85308</b>	<b>89422</b>		...
		57905-1		...	...	010	<b>85976</b>	...
		57905-2		...	...	010	<b>85006</b>	...
		665682		010	<b>85053</b>	<b>89442</b>		...
		CP-5222		...	...	010	<b>85315</b>	...
		Intercambios Adicionales de E.O.	1011839	010	<b>83216</b>	...		...
	35901-3406		010	<b>85305</b>				
	35901-3409		010	<b>85304</b>				
	35901-3410		010	<b>85307</b>				
	35901-3413		010	<b>85006</b>				
	35901-3420		010	<b>85303 or 89422</b>				
	615016		010	<b>83401</b>				
	676081 676082		010 010	<b>83401</b> <b>83401</b>				

**WESTERN STAR AMORTIGUADORES DE CABINA**





	Modelos 6900	725470	010	<b>83010</b>			
	Modelos con Número de E.O.	617547	010	<b>83022</b>			
		654846	01-	<b>83027</b>			
		654916	010	<b>83026</b>			
	Modelos con Suspensión Link Cab	1201-0022	010	<b>83046</b>			
		1202-0022	010	<b>83046</b>			
		1202-0032	010	<b>83016</b>			
	Modelos de Cabina Constellation Day	18-60772-000	010	<b>83026</b>			
		66010-3405	010	<b>83026</b>			
		81-4903003500	010	<b>83026</b>			
	Modelos de Cabina Dormitorio Constellation	18-60773-000	01-	<b>83027</b>			
		66010-3406	01-	<b>83027</b>			
		814903003501	01-	<b>83027</b>			
	Modelos Heritage Constellation	66010-3404	010	<b>83022</b>			
	Modelos SX 6900	66010-3407	010	<b>83065</b>			
<b>86 -</b>	Tractos Convencionales con Modelo Link Cabmate WSC4000	1201-0012	010	<b>83023</b>			
		1202-0012	010	<b>83023</b>			

**WESTERN UNIT "STABILAIRE" SUSPENSION**

	Modelo TDA204, 205, 242 - Suspensión de Eje Motriz	.....		...	...	010	<b>85307</b>	...
	Suspensión de Eje Motriz	.....		...	...	010	<b>85307</b>	...



## GUÍA DE APLICACIONES – CAMIONES, TRÁILERS Y AUTOBUSES

Año	Modelo	# E.O.	Delantero		Trasero	
						
			Fleetline	GasSLX	Fleetline	GasSLX

### WESTERN UNIT "STABILAIRE" SUSPENSION (Cont.)

	Suspensión de Eje Motriz Modelo TDA202, 203, 206, 240, 241, 243	.....		...	...	OIO	<b>85735</b>	...
	Suspensión de Tráiler Modelo 893T	.....		...	...	OIO	<b>85307</b>	...
	Modelos con Número de E.O.	101030		...	...	OIO	<b>85307</b>	...
		101364		...	...	OIO	<b>85305</b>	...
		4939967		...	...	OIO	<b>85308</b>	89422
		80370		...	...	OIO	<b>85304</b>	...
		80600		...	...	OIO	<b>85300</b>	89419

### WINNEBAGO

#### MotorHomes Clase A

<b>03 - 06</b>	MotorHomes Series Journey con Chasis Freightliner XC Amortiguador Trasero con Número de E.O.	141700131809		...	...	OIO	<b>85029</b>	...	
		16-16736-000		...	...	OIO	<b>85029</b>	...	
		Suspensión Delantera AS120	141700131810	OIO	<b>83160</b>	...	...	...	...
			16-16737-000	OIO	<b>83160</b>	...	...	...	...
			16-16874-000	OIO	<b>83160</b>	...	...	...	...
		Suspensión Delantera ZF - IFS con PBV de 23,000 lb o mayor	16-18103-000	-I-	<b>85900</b>	...	...	...	...
			481700000493	-I-	<b>85900</b>	...	...	...	...
	Suspensión Trasera ADL200 de 20K	16-16873-000		...	...	OIO	<b>85029</b>	...	
<b>06</b>	MotorHomes Series Tour con Chasis Freightliner XC Amortiguador Trasero con Número de E.O.	141700131809		...	...	OIO	<b>85029</b>	...	
		16-16736-000		...	...	OIO	<b>85029</b>	...	
		Suspensión Delantera AS120	141700131810	OIO	<b>83160</b>	...	...	...	
			16-16737-000	OIO	<b>83160</b>	...	...	...	
			16-16874-000	OIO	<b>83160</b>	...	...	...	
		Suspensión Delantera ZF - IFS con PBV de 23,000 lb o mayor	16-18103-000	-I-	<b>85900</b>	...	...	...	
			481700000493	-I-	<b>85900</b>	...	...	...	
	Suspensión Trasera ADL200 de 20K	16-16873-000		...	...	OIO	<b>85029</b>	...	
<b>04 - 06</b>	MotorHomes Series Vetra con Chasis Freightliner XC Amortiguador Trasero con Número de E.O.	141700131809		...	...	OIO	<b>85029</b>	...	
		16-16736-000		...	...	OIO	<b>85029</b>	...	
		Suspensión Delantera AS120	141700131810	OIO	<b>83160</b>	...	...	...	
			16-16737-000	OIO	<b>83160</b>	...	...	...	
			16-16874-000	OIO	<b>83160</b>	...	...	...	
		Suspensión Delantera ZF - IFS con PBV de 23,000 lb o mayor	16-18103-000	-I-	<b>85900</b>	...	...	...	
			481700000493	-I-	<b>85900</b>	...	...	...	
	Suspensión Trasera ADL200 de 20K	16-16873-000		...	...	OIO	<b>85029</b>	...	

### WORKHORSE

	Modelos con Número de E.O.	659222	OIO	<b>83171</b>	...	...		...
		659223		...	...	OIO	<b>G63866</b>	...
		680672		...	...	OIO	<b>85919</b>	...
	Modelos con Suspensión Trasera RSAS	7805-X-1012		...	...	OIO	<b>85919</b>	...
	Modelos Step Van con Número de E.O.	W0007363	OIO	<b>83171</b>	...	...	...	...
		W0007365		...	...	OIO	<b>G63866</b>	...

## LISTA NUMÉRICA

Fleetline	APLICACIÓN	No. Kit	Fleetline	APLICACIÓN	No. Kit	Fleetline	APLICACIÓN	No. Kit
<b>Amortiguadores para Aplicaciones Especiales</b>			<b>G63396</b>		<b>140780</b>	<b>G63714</b>		<b>142731</b>
			FORD			FORD		
			<b>G63398</b>		<b>141138</b>	<b>G63716</b>		<b>142731</b>
			FORD			FORD		
			MITSUBISHI-FUSO			<b>G63772</b>		<b>141665</b>
			<b>G63403</b>		<b>No Req.</b>	FORD		
			FREIGHTLINER			<b>G63773</b>		<b>No Req.</b>
			VOLVO			FORD		
<b>83176</b>	<b>N</b>	<b>No Req.</b>	<b>G63405</b>		<b>140884</b>	<b>G63775</b>		<b>No Req.</b>
VARIOS			MITSUBISHI-FUSO			FORD		
<b>85308</b>		<b>401754(4)</b>	<b>G63406</b>		<b>No Req.</b>	<b>G63778</b>		<b>142700</b>
MILITARY			FORD			FORD		
<b>632147</b>		<b>No Req.</b>	<b>G63409</b>		<b>No Req.</b>	<b>G63808</b>		<b>No Req.</b>
CHALLENGE			FORD			FORD		
LINK/HIGH-STEER			<b>G63414</b>		<b>140780</b>	<b>G63809</b>		<b>No Req.</b>
MC NEILUS TRUCK & MAN.			FORD			FORD		
WATSON & CHALIN MFG. INC.			<b>G63419</b>		<b>No Req.</b>	FORD		
			HINO			STERLING TRUCK		
<b>646155</b>		<b>No Req.</b>	<b>G63432</b>		<b>141349 &amp; 140169</b>	<b>G63810</b>		<b>No Req.</b>
ADVANCE MIXER			INTERNATIONAL (NAVISTAR)			FORD		
GRANNING SUSPENSION			NISSAN			<b>G63811</b>		<b>No Req.</b>
HENDRICKSON TRAILER SUSPENSION SYSTEMS			<b>G63440</b>		<b>No Req.</b>	FORD		
KIMBLE MIXER CO			HINO			<b>G63837</b>		<b>No Req.</b>
LINK/HIGH-STEER			<b>G63455</b>		<b>No Req.</b>	FORD		
LONDON MIXER			FORD			<b>G63866</b>		<b>No Req.</b>
MC NEILUS TRUCK & MAN.			<b>G63461</b>		<b>No Req.</b>	MOR-RYDE SUSPENSION		
REX MIXER			FORD			WORKHORSE		
RIDEWELL CORPORATION			<b>G63484</b>		<b>140524</b>	<b>G63929</b>		<b>140780</b>
SAF HOLLAND			VOLVO			FORD		
SUSPENSIONS INC.			<b>G63500</b>		<b>140780</b>	<b>G63969</b>		<b>143146</b>
TEREX CORPORATION			FORD			FORD		
TUTHILL TECHNOLOGIES			<b>G63511</b>		<b>141353</b>	<b>Aplicaciones Fleetline</b>		
WATSON & CHALIN MFG. INC.			FORD			<b>83001</b>	<b>404702(1)</b>	
			<b>G63524</b>		<b>No Req.</b>	FREIGHTLINER AMORTIGUADORES DE CABINA		
			FORD			<b>83002</b>	<b>No Req.</b>	
<b>646177</b>		<b>No Req.</b>	<b>G63525</b>		<b>No Req.</b>	KENWORTH AMORTIGUADORES DE CABINA		
CHALLENGE			FORD			LINK MANUFACTURING AMORTIGUADORES DE CABINA		
LINK/HIGH-STEER			<b>G63605</b>		<b>140169</b>	<b>83003</b>	<b>140455(1)</b>	
OSHKOSH MOTORS			DODGE TRUCK			MACK AMORTIGUADORES DE CABINA		
PIERCE MANUFACTURING INC.			FREIGHTLINER			<b>83004</b>	<b>No Req.</b>	
SAF HOLLAND			JOHN DEERE			VOLVO AMORTIGUADORES DE CABINA		
SPRING VALLEY			OSHKOSH MOTORS			<b>83005</b>	<b>140455(1)</b>	
WESTPORT AXLE CORP			VOLVO			INTERNATIONAL (NAVISTAR) AMORTIGUADORES DE CABINA		
			<b>G63607</b>		<b>140719</b>	LINK MANUFACTURING AMORTIGUADORES DE CABINA		
			FORD			<b>83006</b>	<b>404702(1)</b>	
<b>665472</b>		<b>No Req.</b>	<b>G63608</b>		<b>140780</b>	FREIGHTLINER AMORTIGUADORES DE CABINA		
INGERSALL MACHINE			FORD			<b>83007</b>	<b>404702(2) &amp; 140702(1)</b>	
<b>665937</b>		<b>No Req.</b>	<b>G63610</b>		<b>142389</b>	MACK AMORTIGUADORES DE CABINA		
LINK/HIGH-STEER			CHEVROLET TRUCK (Ver también GMC)			<b>83008</b>	<b>No Req.</b>	
REYCO SUSPENSION			GMC TRUCK			KENWORTH PETERBILT AMORTIGUADORES DE CABINA		
RIDEWELL CORPORATION			HINO			<b>83009</b>	<b>No Req.</b>	
			INTERNATIONAL (NAVISTAR)			FREIGHTLINER AMORTIGUADORES DE CABINA		
			ISUZU			MC NEILUS TRUCK & MAN. OSHKOSH MOTORS AMORTIGUADORES DE CABINA		
<b>G63183</b>		<b>No Req.</b>	MITSUBISHI-FUSO			<b>83010</b>	<b>No Req.</b>	
CHRYSLER			<b>G63616</b>		<b>140169 &amp; 142656</b>	WESTERN STAR AMORTIGUADORES DE CABINA		
DODGE TRUCK			CHEVROLET TRUCK (Ver también GMC)			<b>83011</b>	<b>404702(2)</b>	
FREIGHTLINER			GMC TRUCK			KENWORTH AMORTIGUADORES DE CABINA		
HOLIDAY RAMBLER			ISUZU			PETERBILT AMORTIGUADORES DE CABINA		
JOHN DEERE			VOLVO			<b>83012</b>	<b>404702(2)</b>	
MOR-RYDE SUSPENSION			<b>G63622</b>		<b>142617</b>	KENWORTH AMORTIGUADORES DE CABINA		
OSHKOSH MOTORS			FORD			PETERBILT AMORTIGUADORES DE CABINA		
VOLVO			<b>G63623</b>		<b>142617</b>	<b>83013</b>	<b>No Req.</b>	
<b>G63299</b>		<b>140885(1)</b>	<b>G63624</b>		<b>140780</b>	INTERNATIONAL (NAVISTAR) AMORTIGUADORES DE CABINA		
FORD			FORD			<b>83014</b>	<b>140455(2)</b>	
INTERNATIONAL (NAVISTAR)			<b>G63625</b>		<b>140702</b>	INTERNATIONAL (NAVISTAR) AMORTIGUADORES DE CABINA		
MITSUBISHI-FUSO			VOLVO					
<b>G63306</b>		<b>No Req.</b>	<b>G63626</b>		<b>No Req.</b>			
FORD			FORD					
INTERNATIONAL (NAVISTAR)			<b>G63627</b>		<b>No Req.</b>			
<b>G63347</b>		<b>No Req.</b>	<b>G63628</b>		<b>No Req.</b>			
CHEVROLET TRUCK (Ver también GMC)			FORD					
GMC TRUCK			<b>G63676</b>		<b>No Req.</b>			
<b>G63350</b>		<b>140126</b>	FORD					
FORD			<b>G63677</b>		<b>No Req.</b>			
<b>G63355</b>		<b>140702</b>	<b>G63678</b>		<b>No Req.</b>			
CHALMERS SUSPENSION			FORD					
<b>G63357</b>		<b>No Req.</b>	<b>G63679</b>		<b>140719</b>			
WATSON & CHALIN MFG. INC.			FORD					
<b>G63386</b>		<b>140780</b>						
FORD								
STERLING TRUCK								
<b>G63387</b>		<b>140126</b>						
FORD								
STERLING TRUCK								

N = Nuevo

# LISTA NUMÉRICA

Fleetline	APLICACIÓN	No. Kit	Fleetline	APLICACIÓN	No. Kit	Fleetline	APLICACIÓN	No. Kit
83014	MACK AMORTIGUADORES DE CABINA	140455(2)	83030	VOLVO AMORTIGUADORES DE CABINA	No Req.	83053	INTERNATIONAL (NAVISTAR) AMORTIGUADORES DE CABINA	No Req.
83015	INTERNATIONAL (NAVISTAR) AMORTIGUADORES DE CABINA	140455(1)	83031	KENWORTH AMORTIGUADORES DE CABINA LINK MANUFACTURING AMORTIGUADORES DE CABINA	No Req.	83054	INTERNATIONAL (NAVISTAR) AMORTIGUADORES DE CABINA LINK MANUFACTURING AMORTIGUADORES DE CABINA	No Req.
83016	CHEVROLET TRUCK AMORTIGUADORES DE CABINA FORD AMORTIGUADORES DE CABINA FREIGHTLINER AMORTIGUADORES DE CABINA GMC TRUCK AMORTIGUADORES DE CABINA INTERNATIONAL (NAVISTAR) AMORTIGUADORES DE CABINA KENWORTH AMORTIGUADORES DE CABINA LINK MANUFACTURING AMORTIGUADORES DE CABINA MACK AMORTIGUADORES DE CABINA PETERBILT AMORTIGUADORES DE CABINA VOLVO AMORTIGUADORES DE CABINA WESTERN STAR AMORTIGUADORES DE CABINA	No Req.	83032	FREIGHTLINER AMORTIGUADORES DE CABINA INTERNATIONAL (NAVISTAR) AMORTIGUADORES DE CABINA KENWORTH AMORTIGUADORES DE CABINA LINK MANUFACTURING AMORTIGUADORES DE CABINA	No Req.	83056	KENWORTH AMORTIGUADORES DE CABINA LINK MANUFACTURING AMORTIGUADORES DE CABINA	No Req.
83017	FREIGHTLINER AMORTIGUADORES DE CABINA	No Req.	83033	FORD AMORTIGUADORES DE CABINA FREIGHTLINER AMORTIGUADORES DE CABINA STERLING TRUCK AMORTIGUADORES DE CABINA	No Req.	83057	FREIGHTLINER AMORTIGUADORES DE CABINA STERLING TRUCK AMORTIGUADORES DE CABINA	No Req.
83018	MACK AMORTIGUADORES DE CABINA	140780(1)	83034	FORD AMORTIGUADORES DE CABINA FREIGHTLINER AMORTIGUADORES DE CABINA STERLING TRUCK AMORTIGUADORES DE CABINA	No Req.	83058	MACK AMORTIGUADORES DE CABINA	140780(1)
83019	MACK AMORTIGUADORES DE CABINA	140780(1)	83035	KENWORTH AMORTIGUADORES DE CABINA PETERBILT AMORTIGUADORES DE CABINA	No Req.	83059	KENWORTH AMORTIGUADORES DE CABINA PETERBILT AMORTIGUADORES DE CABINA POWERPACKER AMORTIGUADORES DE CABINA	No Req.
83020	FREIGHTLINER AMORTIGUADORES DE CABINA	No Req.	83038	FREIGHTLINER AMORTIGUADORES DE CABINA	404702(1)	83060	PETERBILT AMORTIGUADORES DE CABINA POWERPACKER AMORTIGUADORES DE CABINA	No Req.
83021	CHEVROLET TRUCK AMORTIGUADORES DE CABINA FREIGHTLINER AMORTIGUADORES DE CABINA GMC TRUCK AMORTIGUADORES DE CABINA INTERNATIONAL (NAVISTAR) AMORTIGUADORES DE CABINA KENWORTH AMORTIGUADORES DE CABINA LINK MANUFACTURING AMORTIGUADORES DE CABINA MARMON AMORTIGUADORES DE CABINA OSHKOSH MOTORS AMORTIGUADORES DE CABINA PETERBILT AMORTIGUADORES DE CABINA	No Req.	83039	FREIGHTLINER AMORTIGUADORES DE CABINA	No Req.	83061	LINK MANUFACTURING AMORTIGUADORES DE CABINA PETERBILT AMORTIGUADORES DE CABINA	No Req.
83022	WESTERN STAR AMORTIGUADORES DE CABINA	No Req.	83040	FREIGHTLINER AMORTIGUADORES DE CABINA	No Req.	83062	INTERNATIONAL (NAVISTAR) AMORTIGUADORES DE CABINA LINK MANUFACTURING AMORTIGUADORES DE CABINA	145128(1)
83023	CHEVROLET TRUCK AMORTIGUADORES DE CABINA FORD AMORTIGUADORES DE CABINA FREIGHTLINER AMORTIGUADORES DE CABINA GMC TRUCK AMORTIGUADORES DE CABINA INTERNATIONAL (NAVISTAR) AMORTIGUADORES DE CABINA KENWORTH AMORTIGUADORES DE CABINA LINK MANUFACTURING AMORTIGUADORES DE CABINA MACK AMORTIGUADORES DE CABINA PETERBILT AMORTIGUADORES DE CABINA VOLVO AMORTIGUADORES DE CABINA WESTERN STAR AMORTIGUADORES DE CABINA	No Req.	83041	MACK AMORTIGUADORES DE CABINA	140780(1)	83063	KENWORTH AMORTIGUADORES DE CABINA PETERBILT AMORTIGUADORES DE CABINA	No Req.
83024	KENWORTH AMORTIGUADORES DE CABINA LINK MANUFACTURING AMORTIGUADORES DE CABINA PETERBILT AMORTIGUADORES DE CABINA	No Req.	83042	KENWORTH AMORTIGUADORES DE CABINA PETERBILT AMORTIGUADORES DE CABINA	No Req.	83064	FREIGHTLINER AMORTIGUADORES DE CABINA	No Req.
83025	FORD AMORTIGUADORES DE CABINA FREIGHTLINER AMORTIGUADORES DE CABINA GMC TRUCK AMORTIGUADORES DE CABINA INTERNATIONAL (NAVISTAR) AMORTIGUADORES DE CABINA KENWORTH AMORTIGUADORES DE CABINA LINK MANUFACTURING AMORTIGUADORES DE CABINA PETERBILT AMORTIGUADORES DE CABINA STERLING TRUCK AMORTIGUADORES DE CABINA	No Req.	83043	VOLKSWAGEN AMORTIGUADORES DE CABINA	No Req.	83065	C WESTERN STAR AMORTIGUADORES DE CABINA	No Req.
83026	FREIGHTLINER AMORTIGUADORES DE CABINA WESTERN STAR AMORTIGUADORES DE CABINA	No Req.	83044	FREIGHTLINER AMORTIGUADORES DE CABINA	No Req.	83066	C MACK AMORTIGUADORES DE CABINA	No Req.
83027	FREIGHTLINER AMORTIGUADORES DE CABINA WESTERN STAR AMORTIGUADORES DE CABINA	140126(1)	83045	MACK AMORTIGUADORES DE CABINA	140780(1)	83100	INTERNATIONAL (NAVISTAR) MERCEDES BENZ VOLVO	No Req.
83028	VOLVO AMORTIGUADORES DE CABINA	No Req.	83046	CHEVROLET TRUCK AMORTIGUADORES DE CABINA FORD AMORTIGUADORES DE CABINA FREIGHTLINER AMORTIGUADORES DE CABINA GMC TRUCK AMORTIGUADORES DE CABINA INTERNATIONAL (NAVISTAR) AMORTIGUADORES DE CABINA KENWORTH AMORTIGUADORES DE CABINA LINK MANUFACTURING AMORTIGUADORES DE CABINA MACK AMORTIGUADORES DE CABINA MARMON AMORTIGUADORES DE CABINA PETERBILT AMORTIGUADORES DE CABINA VOLVO AMORTIGUADORES DE CABINA WESTERN STAR AMORTIGUADORES DE CABINA	No Req.	83101	INTERNATIONAL (NAVISTAR) MACK VOLVO	No Req.
83029	VOLVO AMORTIGUADORES DE CABINA	No Req.	83047	FREIGHTLINER AMORTIGUADORES DE CABINA	404702(1)	83102	THOMAS SCHOOL BUS	145089-000(2)
			83048	VOLVO AMORTIGUADORES DE CABINA	No Req.	83103	INTERNATIONAL (NAVISTAR) MITSUBISHI-FUSO MOR-RYDE SUSPENSION VOLVO	145054(2)
			83049	KENWORTH AMORTIGUADORES DE CABINA LINK MANUFACTURING AMORTIGUADORES DE CABINA PETERBILT AMORTIGUADORES DE CABINA	No Req.	83104	GMC TRUCK HINO VOLVO	No Req.
			83050	MACK AMORTIGUADORES DE CABINA VOLVO AMORTIGUADORES DE CABINA	140780(1)	83105	MACK VOLVO	140780(1)
			83051	INTERNATIONAL (NAVISTAR) AMORTIGUADORES DE CABINA LINK MANUFACTURING AMORTIGUADORES DE CABINA	No Req.	83107	FORD MAECO STERLING TRUCK	145080(2)
			83052	INTERNATIONAL (NAVISTAR) AMORTIGUADORES DE CABINA LINK MANUFACTURING AMORTIGUADORES DE CABINA	No Req.	83109	FORD HENDRICKSON TRUCK SUSPENSION SYSTEMS MC NEILUS TRUCK & MAN. STERLING TRUCK	145128(1)
						83110	HENDRICKSON TRUCK SUSPENSION SYSTEMS MACK	145128(1)

# LISTA NUMÉRICA

Fleetline	APLICACIÓN	No. Kit	Fleetline	APLICACIÓN	No. Kit	Fleetline	APLICACIÓN	No. Kit
83111	HENDRICKSON TRUCK SUSPENSION SYSTEMS MACK WESTERN STAR	145128(1)	83123	FORD GILLIG BROS. HENDRICKSON TRUCK SUSPENSION SYSTEMS INTERNATIONAL (NAVISTAR) KENWORTH MACK MAECO MARMON MC NEILUS TRUCK & MAN. PETERBILT REYCO SUSPENSION SAF HOLLAND TUTHILL TECHNOLOGIES VOLVO WATSON & CHALIN MFG. INC.	No Req.	83136	CHAMPION TRANSIT CHEVROLET TRUCK (Ver también GMC) GMC TRUCK ISUZU KENWORTH PETERBILT	145054(2)
83112	ADVANCE MIXER HENDRICKSON TRUCK SUSPENSION SYSTEMS INTERNATIONAL (NAVISTAR) MACK MC NEILUS TRUCK & MAN. VOLVO	145128(1)	83124	BENSON TRUCK BODIES INC. BLUEBIRD SCHOOL BUS EAST MANUFACTURING CORP. KENWORTH PETERBILT SAF HOLLAND TRAILMOBILE CANADA CORP. TWIN COACH VOLVO WABASH NATIONAL	No Req.	83137	BLUEBIRD SCHOOL BUS HENDRICKSON TRUCK SUSPENSION SYSTEMS KENWORTH MACK MC NEILUS TRUCK & MAN. PETERBILT	No Req.
83113	SAF HOLLAND STOUGHTON TRAILERS INC. TRAILMOBILE CANADA CORP. WABASH NATIONAL	No Req.	83125	CASCADE TRAILER EAST MANUFACTURING CORP. FORD GENERAL TRAILER CO HENDRICKSON TRUCK SUSPENSION SYSTEMS HOLLAND - BINKLEY MACK MAECO PEERLESS TRAILER SAF HOLLAND STERLING TRUCK THE BINKLEY COMPANY TRAILMOBILE CANADA CORP. VOLVO WABASH NATIONAL WATSON & CHALIN MFG. INC.	No Req.	83138	MACK	145128(1)
83114	CHEVROLET TRUCK (Ver también GMC) GMC TRUCK INTERNATIONAL (NAVISTAR) ISUZU NISSAN	140780(1)	83126	CHEVROLET TRUCK (Ver también GMC) GMC TRUCK HINO INTERNATIONAL (NAVISTAR) KENWORTH MAECO REYCO SUSPENSION SAF HOLLAND TUTHILL TECHNOLOGIES VOLVO WABASH NATIONAL	No Req.	83140	FORD HINO	415010-802(2) & 145148(2)
83115	SAF HOLLAND TRAILMOBILE CANADA CORP.	No Req.	83127	BLUEBIRD SCHOOL BUS FREIGHTLINER FREIGHTLINER CUSTOM CHASSIS HOLIDAY RAMBLER MC NEILUS TRUCK & MAN. OSHKOSH MOTORS SAF HOLLAND TRAILMOBILE CANADA CORP. VOLVO WABASH NATIONAL	No Req.	83141	HINO	415010-802(2) & 145148(2)
83116	FREIGHTLINER CUSTOM CHASSIS	No Req.	83128	EAST MANUFACTURING CORP. FREIGHTLINER GREAT DANE TRAILER HENDRICKSON TRAILER SUSPENSION SYSTEMS MC NEILUS TRUCK & MAN. SAF HOLLAND STOUGHTON TRAILERS INC. TWIN COACH VOLVO WABASH NATIONAL	No Req.	83142	HENDRICKSON TRUCK SUSPENSION SYSTEMS KENWORTH MC NEILUS TRUCK & MAN. PETERBILT	145128(1)
83117	FREIGHTLINER FREIGHTLINER CUSTOM CHASSIS OSHKOSH MOTORS	404702(1)	83129	BEARING TRUCK CORP. CHEVROLET TRUCK (Ver también GMC) GMC TRUCK HENDRICKSON TRUCK SUSPENSION SYSTEMS INTERNATIONAL (NAVISTAR) ISUZU KENWORTH PETERBILT SAF HOLLAND VOLVO WESTERN STAR	No Req.	83143	HENDRICKSON TRUCK SUSPENSION SYSTEMS INTERNATIONAL (NAVISTAR) KENWORTH MC NEILUS TRUCK & MAN. PETERBILT	145128(1)
83118	FREIGHTLINER FREIGHTLINER CUSTOM CHASSIS MAECO OSHKOSH MOTORS UPS TRUCK	No Req.	83130	RIDEWELL CORPORATION SAF HOLLAND VOLVO WABASH NATIONAL	No Req.	83144	HENDRICKSON TRUCK SUSPENSION SYSTEMS INTERNATIONAL (NAVISTAR)	No Req.
83119	FREIGHTLINER CUSTOM CHASSIS OSHKOSH MOTORS	No Req.	83131	FORD	No Req.	83145	FORD INTERNATIONAL (NAVISTAR)	No Req.
83120	FREIGHTLINER FREIGHTLINER CUSTOM CHASSIS MAECO OSHKOSH MOTORS STERLING TRUCK THOMAS SCHOOL BUS UPS TRUCK VOLVO	145089-000(1) & 145143(1)	83132	FORD GILLIG BROS. HENDRICKSON TRUCK SUSPENSION SYSTEMS INTERNATIONAL (NAVISTAR) KENWORTH MACK MAECO MARMON MC NEILUS TRUCK & MAN. MONACO OSHKOSH MOTORS PETERBILT REYCO SUSPENSION SAF HOLLAND TUTHILL TECHNOLOGIES VOLVO WESTERN STAR	No Req.	83146	FORD INTERNATIONAL (NAVISTAR) STERLING TRUCK	No Req.
83121	BERING TRUCK CORP. CHEVROLET TRUCK (Ver también GMC) GMC TRUCK HENDRICKSON TRUCK SUSPENSION SYSTEMS INTERNATIONAL (NAVISTAR) ISUZU KENWORTH PETERBILT SAF HOLLAND VOLVO WESTERN STAR	No Req.	83133	IC CORPORATION INTERNATIONAL (NAVISTAR)	No Req.	83147	HENDRICKSON TRUCK SUSPENSION SYSTEMS MACK MC NEILUS TRUCK & MAN.	No Req.
83122	ALLCO TRAILER AUTOCAR CHEVROLET TRUCK (Ver también GMC) FORD FREIGHTLINER FRUEHAUF GILLIG BROS. GMC TRUCK GREAT DANE TRAILER HENDRICKSON TRUCK SUSPENSION SYSTEMS HOLIDAY RAMBLER ISUZU KENWORTH LODAL, INC. MACK MAECO MARMON MC NEILUS TRUCK & MAN. MONACO OSHKOSH MOTORS PETERBILT REYCO SUSPENSION SAF HOLLAND TUTHILL TECHNOLOGIES VOLVO WESTERN STAR	No Req.	83134	FREIGHTLINER	145054(1)	83148	HENDRICKSON TRUCK SUSPENSION SYSTEMS HINO MC NEILUS TRUCK & MAN.	No Req.
			83135	FORD IC CORPORATION INTERNATIONAL (NAVISTAR)	No Req.	83149	HENDRICKSON TRUCK SUSPENSION SYSTEMS MC NEILUS TRUCK & MAN.	No Req.
						83150	HENDRICKSON TRAILER SUSPENSION SYSTEMS SAF HOLLAND	No Req.
						83153	CHEVROLET TRUCK (Ver también GMC) GMC TRUCK	No Req.
						83154	FREIGHTLINER CUSTOM CHASSIS	145089-000(1)
						83155	CHEVROLET TRUCK (Ver también GMC) GMC TRUCK	No Req.
						83156	IC CORPORATION INTERNATIONAL (NAVISTAR)	No Req.
						83157	FREIGHTLINER CUSTOM CHASSIS	No Req.
						83158	MOTOR COACH INDUSTRIES	No Req.
						83159	GMC TRUCK ISUZU	TR0027(4)
						83160	COACHMEN RV FLEETWOOD RV FOREST RIVER INC	No Req.

# LISTA NUMÉRICA

Fleetline	APLICACIÓN	No. Kit	Fleetline	APLICACIÓN	No. Kit	Fleetline	APLICACIÓN	No. Kit
<b>83160</b>	FREIGHTLINER CUSTOM CHASSIS GULF STREAM COACH HOLIDAY RAMBLER ITASCA KING OF THE ROAD MANDALAY COACH MONACO NEWMAR CORP THOR MOTOR COACH WINNEBAGO	No Req.	<b>83203</b>	VOLVO WABASH NATIONAL WATSON & CHALIN MFG. INC.	No Req.	<b>83216</b>	CHEVROLET TRUCK (Ver también GMC) FORD GILLIG BROS. GMC TRUCK HINO INTERNATIONAL (NAVISTAR) MACK MAECO MARMON MOHAWK NEOPLAN BUS ONEIDA PRODUCTS STERLING TRUCK VOLVO WESTERN STAR	140149(1)
<b>83161</b>	FORD GMC TRUCK NISSAN	140524(1) & 404702(1)	<b>83204</b>	DUPLEX TRUCK DURA SUSPENSION MAECO PAGE SUSPENSION REYCO SUSPENSION SAF HOLLAND TRAILMOBILE CANADA CORP. TUTHILL TECHNOLOGIES VOLVO WATSON & CHALIN MFG. INC.	No Req.	<b>83217</b>	CHEVROLET TRUCK (Ver también GMC) DIAMOND-REO EAST MANUFACTURING CORP. FLXIBLE BUS FORD GMC TRUCK HINO HYSTER MACK MAECO OLE GRANNING OTTAWA TRUCK REYCO SUSPENSION SOUTHERN COACH TUTHILL TECHNOLOGIES VOLVO	401754(4)
<b>83162</b>	NISSAN	140780(1) & 145116 & 406422 & 415010-802(1)	<b>83207</b>	ADVANCE MIXER BLUEBIRD SCHOOL BUS BROCKWAY SCHOOL BUS CHANCE BUS CHEVROLET TRUCK (Ver también GMC) DURA SUSPENSION FORD GILLIG BROS. GMC TRUCK GREAT DANE TRAILER HARDEE MFG HENDRICKSON TRUCK SUSPENSION SYSTEMS HIGHWAY PRODUCT INTERNATIONAL (NAVISTAR) MACK MAECO MC NEILUS TRUCK & MAN. MOHAWK NATIONAL COACH CORP OSHKOSH MOTORS REYCO SUSPENSION RIDEWELL CORPORATION SAF HOLLAND TRAILMOBILE CANADA CORP. TUTHILL TECHNOLOGIES TWIN COACH VOLVO WABASH NATIONAL	No Req.	<b>83219</b>	CHEVROLET TRUCK (Ver también GMC) FORD GILLIG BROS. GMC TRUCK PETERBILT VOLVO	140149(1)
<b>83163</b>	IC CORPORATION INTERNATIONAL (NAVISTAR)	No Req.	<b>83209</b>	ADVANCE MIXER CHEVROLET TRUCK (Ver también GMC) FORD GMC TRUCK HENDRICKSON TRAILER SUSPENSION SYSTEMS HOLIDAY RAMBLER INTERNATIONAL (NAVISTAR) KENWORTH MACK MAECO MC NEILUS TRUCK & MAN. MONACO PETERBILT REYCO SUSPENSION SAF HOLLAND TRAILMOBILE CANADA CORP. TUTHILL TECHNOLOGIES VOLVO WESTERN STAR	No Req.	<b>83221</b>	CHEVROLET TRUCK (Ver también GMC) GMC TRUCK KENWORTH MACK MAECO OSHKOSH MOTORS PAI CORP PETERBILT REYCO SUSPENSION TUTHILL TECHNOLOGIES VOLVO	No Req.
<b>83164</b>	FREIGHTLINER CUSTOM CHASSIS	No Req.	<b>83214</b>	CHEVROLET TRUCK (Ver también GMC) DIAMOND-REO EAST MANUFACTURING CORP. GMC TRUCK GRANNING SUSPENSION MAECO OSTERLUND TRUCK OTTAWA TRUCK SPARTAN MOTORS TUTHILL TECHNOLOGIES VOLVO	401754(4)	<b>83225</b>	ACF BRILL BUS FORD FREIGHTLINER HENDRICKSON TRUCK SUSPENSION SYSTEMS INTERNATIONAL (NAVISTAR) MACK MOHAWK TRAILMOBILE CANADA CORP. VOLVO	401754(4)
<b>83165</b>	VOLVO	No Req.	<b>83215</b>	ACF BRILL BUS BROCKWAY SCHOOL BUS CHEVROLET TRUCK (Ver también GMC) FORD GMC TRUCK HINO INTERNATIONAL (NAVISTAR) MACK MAECO PAI CORP REYCO SUSPENSION STERLING TRUCK TUTHILL TECHNOLOGIES VOLVO	401754(4)	<b>83242</b>	MACK VOLVO	No Req.
<b>83166</b>	HENDRICKSON TRUCK SUSPENSION SYSTEMS HINO	No Req.	<b>83216</b>	AUTOCAR BROCKWAY SCHOOL BUS	140149(1)	<b>83301</b>	INTERNATIONAL (NAVISTAR) VOLVO	141083(1)
<b>83167</b>	INTERNATIONAL (NAVISTAR)	No Req.				<b>83303</b>	CHEVROLET TRUCK (Ver también GMC) GMC TRUCK VOLVO	140702(1)
<b>83168</b>	HENDRICKSON TRUCK SUSPENSION SYSTEMS MC NEILUS TRUCK & MAN.	No Req.				<b>83304</b>	CHEVROLET TRUCK (Ver también GMC) GMC TRUCK VOLVO	140702(1)
<b>83169</b>	IC CORPORATION INTERNATIONAL (NAVISTAR)	No Req.				<b>83308</b>	CHEVROLET TRUCK (Ver también GMC) FORD GMC TRUCK INTERNATIONAL (NAVISTAR) STERLING TRUCK VOLVO	140149(1)
<b>83171</b>	WORKHORSE	No Req.				<b>83309</b>	FORD INTERNATIONAL (NAVISTAR) STERLING TRUCK VOLVO	140149(1)
<b>83172</b>	MERCEDES BENZ	No Req.				<b>83312</b>	FORD	140149(1)
<b>83173</b>	MERCEDES BENZ	145168(2)						
<b>83174</b>	FREIGHTLINER CUSTOM CHASSIS	No Req.						
<b>83175</b>	FORD INTERNATIONAL (NAVISTAR)	No Req.						
<b>83176</b>	MAECO	No Req.						
<b>83177</b>	BLUEBIRD SCHOOL BUS HOLIDAY RAMBLER THOMAS SCHOOL BUS	N 140780(1) & 404702(1)						
<b>83178</b>	BLUEBIRD SCHOOL BUS HOLIDAY RAMBLER THOMAS SCHOOL BUS	N 142095(1)						
<b>83179</b>	GMC TRUCK ISUZU	N 401011(4)						
<b>83200</b>	FORD STERLING TRUCK	140149(1)						
<b>83203</b>	CHANCE BUS CHEVROLET TRUCK (Ver también GMC) DURA SUSPENSION FRUEHAUF GMC TRUCK HIGHWAY PRODUCT HUTCHENS SUSPENSION MACK MAECO MOHAWK ORION BUS INDUSTRIES PAGE SUSPENSION PETERBILT REYCO SUSPENSION RIDEWELL CORPORATION SAF HOLLAND TUTHILL TECHNOLOGIES	No Req.						

N = Nueva

# LISTA NUMÉRICA

Fleetline	APLICACIÓN	No. Kit	Fleetline	APLICACIÓN	No. Kit	Fleetline	APLICACIÓN	No. Kit
83312	KENWORTH OSHKOSH MOTORS PETERBILT PIERCE MANUFACTURING INC. VOLVO	140149(1)	83635	SAF HOLLAND VOLVO WESTERN STAR	145054(1)	85007	FREIGHTLINER KENWORTH MACK MAECO PETERBILT REYCO SUSPENSION SPARTAN MOTORS TUTHILL TECHNOLOGIES VOLVO	401754(4)
83314	FORD GMC TRUCK INTERNATIONAL (NAVISTAR) MAECO STERLING TRUCK VOLVO	140149(1)	83636	INTERNATIONAL (NAVISTAR) VOLVO	No Req.	85009	ARVIN MERITOR FREIGHTLINER MITSUBISHI-FUSO NEOPLAN BUS WATSON & CHALIN MFG. INC.	145054(1)
83317	DINA FORD IC CORPORATION INTERNATIONAL (NAVISTAR) VOLVO	141083(1)	85000	ARVIN MERITOR BENSON TRUCK BODIES INC. EAST MANUFACTURING CORP. FREIGHTLINER GREAT DANE TRAILER HENDRICKSON TRAILER SUSPENSION SYSTEMS KENWORTH MC NEILUS TRUCK & MAN. ORION BUS INDUSTRIES PETERBILT RIDEWELL CORPORATION SAF HOLLAND STOUGHTON TRAILERS INC. THOMAS SCHOOL BUS TRAILMOBILE CANADA CORP. TWIN COACH VOLVO WABASH NATIONAL WATSON & CHALIN MFG. INC.	No Req.	85010	BLUEBIRD SCHOOL BUS HENDRICKSON TRAILER SUSPENSION SYSTEMS MACK	No Req.
83318	INTERNATIONAL (NAVISTAR) VOLVO	141083(2)	85001	FORD INTERNATIONAL (NAVISTAR) KENWORTH MACK MAECO PETERBILT REYCO SUSPENSION STERLING TRUCK TUTHILL TECHNOLOGIES VOLVO	401754(4)	85011	FREIGHTLINER	No Req.
83353	KENWORTH PETERBILT VOLVO	145099(1)	85003	INTERNATIONAL (NAVISTAR) KENWORTH MARMON PETERBILT VOLVO	No Req.	85012	ARVIN MERITOR BLUEBIRD SCHOOL BUS BROCKWAY SCHOOL BUS CHANCE COACH CHEVROLET TRUCK (Ver también GMC) FORD GMC TRUCK INTERNATIONAL (NAVISTAR) ISUZU KENWORTH PETERBILT VOLVO	145080(2)
83362	HINO	401754(4)	85004	PETERBILT SAF HOLLAND	401754(4)	85013	BLUEBIRD SCHOOL BUS FORD HENDRICKSON TRAILER SUSPENSION SYSTEMS HENDRICKSON TRUCK SUSPENSION SYSTEMS INTERNATIONAL (NAVISTAR) KENWORTH MAECO MC NEILUS TRUCK & MAN. PETERBILT REYCO SUSPENSION SAF HOLLAND SPARTAN MOTORS STERLING TRUCK TRAILMOBILE CANADA CORP. TUTHILL TECHNOLOGIES VOLVO	No Req.
83400	CHEVROLET TRUCK (Ver también GMC) FORD GMC TRUCK MOR-RYDE SUSPENSION VOLVO WATSON & CHALIN MFG. INC. WESTERN STAR	140455(2)	85005	AUTOCAR BLUEBIRD SCHOOL BUS CHEVROLET TRUCK (Ver también GMC) EAST MANUFACTURING CORP. FORD FREIGHTLINER FREIGHTLINER CUSTOM CHASSIS GMC TRUCK HENDRICKSON TRAILER SUSPENSION SYSTEMS HENDRICKSON TRUCK SUSPENSION SYSTEMS INTERNATIONAL (NAVISTAR) MACK MAECO MERCEDES BENZ REYCO SUSPENSION RIDEWELL CORPORATION SAF HOLLAND TUTHILL TECHNOLOGIES VOLVO WATSON & CHALIN MFG. INC.	No Req.	85014	ARVIN MERITOR CHANCE BUS DINA HARDEE MFG HENDRICKSON TRAILER SUSPENSION SYSTEMS INTERNATIONAL (NAVISTAR) MACK REYCO SUSPENSION RIDEWELL CORPORATION SAF HOLLAND TUTHILL TECHNOLOGIES WATSON & CHALIN MFG. INC.	No Req.
83401	CHEVROLET TRUCK (Ver también GMC) GMC TRUCK VOLVO WESTERN STAR	404702(2)	85006	BLUEBIRD SCHOOL BUS BUILT RITE DEXTER AXLE FORD FREIGHTLINER FREIGHTLINER CUSTOM CHASSIS GREAT DANE TRAILER HENDRICKSON TRAILER SUSPENSION SYSTEMS HENDRICKSON TRUCK SUSPENSION SYSTEMS MAECO MERCEDES BENZ RAMERIZ TRAILER REYCO SUSPENSION RIDEWELL CORPORATION SAF HOLLAND STERLING TRUCK STOUGHTON TRAILERS INC. THE BINKLEY COMPANY THOMAS SCHOOL BUS TRAILMOBILE CANADA CORP. TUTHILL TECHNOLOGIES VOLVO WESTERN STAR	No Req.	85023	INTERNATIONAL (NAVISTAR) KENWORTH MACK PETERBILT VOLVO	140149(1)
83404	GMC TRUCK HINO ISUZU	401011(4)				85024	AUTOCAR INTERNATIONAL (NAVISTAR) MACK VOLVO	140149(1)
83456	IC CORPORATION INTERNATIONAL (NAVISTAR) MITSUBISHI-FUSO VOLVO	142998(2)				85025	VOLVO	140169(1) & 145054(1)
83505	HINO	401011(4)				85026	AUTOCAR GMC TRUCK VOLVO	145054(1)
83506	HINO	401011(4)				85027	INTERNATIONAL (NAVISTAR) VOLVO	145054(2)
83507	HINO	140524(1)				85029	BLUEBIRD SCHOOL BUS COACHMEN RV	No Req.
83508	GMC TRUCK ISUZU	404702(2)						
83509	ISUZU	141041(1) & 404702(1)						
83510	FREIGHTLINER	404702(2)						
83511	HINO	TR0027(4)						
83512	HINO	142656(1) & TR0027(2)						
83513	HINO	141041(1) & TR0027(2)						
83514	HINO	141041(1) & TR0027(2)						
83515	GMC TRUCK ISUZU	141041(1) & TR0027(2)						
83613	INTERNATIONAL (NAVISTAR) THOMAS SCHOOL BUS VOLVO	141083(2)						
83634	FREIGHTLINER	No Req.						

C = Próximo Lanzamiento, N = Nuevo

# LISTA NUMÉRICA

Fleetline	APLICACIÓN	No. Kit	Fleetline	APLICACIÓN	No. Kit	Fleetline	APLICACIÓN	No. Kit
<b>85029</b>	DURA SUSPENSION EAST MANUFACTURING CORP. FLEETWOOD RV FOREST RIVER INC FREIGHTLINER CUSTOM CHASSIS GULF STREAM COACH HENDRICKSON TRAILER SUSPENSION SYSTEMS HOLIDAY RAMBLER INTERNATIONAL (NAVISTAR) ITASCA KENWORTH KING OF THE ROAD MANDALAY COACH MONACO NEWMAR CORP PAGE SUSPENSION PETERBILT RIDEWELL CORPORATION SAF HOLLAND SPARTAN MOTORS THOR MOTOR COACH TRAILMOBILE CANADA CORP. WATSON & CHALIN MFG. INC. WINNEBAGO	No Req.	<b>85047</b>	PETERBILT STERLING TRUCK VOLVO	140149(1)	<b>85067</b>	PETERBILT	No Req.
<b>85030</b>	BLUEBIRD SCHOOL BUS CHEVROLET TRUCK (Ver también GMC) EAST MANUFACTURING CORP. FORD FRUEHAUF GMC TRUCK HENDRICKSON TRAILER SUSPENSION SYSTEMS HENDRICKSON TRUCK SUSPENSION SYSTEMS INTERNATIONAL (NAVISTAR) MAECO OSHKOSH MOTORS PACIFIC TRUCK & TRAILER PIERCE MANUFACTURING INC. REYCO SUSPENSION SAF HOLLAND STERLING TRUCK THOMAS SCHOOL BUS TUTHILL TECHNOLOGIES VOLVO WABASH NATIONAL	No Req.	<b>85050</b>	CHEVROLET TRUCK (Ver también GMC) GMC TRUCK	No Req.	<b>85069</b>	KENWORTH PETERBILT	145089-000(2)
<b>85031</b>	KENWORTH PETERBILT	140169(1) & TR0027(2)	<b>85051</b>	BLUEBIRD SCHOOL BUS GILLIG BROS. MUNCIE RECLAMATION OSHKOSH MOTORS REYCO SUSPENSION SAF HOLLAND STOUGHTON TRAILERS INC. TRAILMOBILE CANADA CORP. TUTHILL TECHNOLOGIES WABASH NATIONAL	No Req.	<b>85070</b>	KENWORTH PETERBILT	401754(2)
<b>85033</b>	INTERNATIONAL (NAVISTAR) KENWORTH MACK PACCAR PETERBILT VOLVO	145099(1)	<b>85052</b>	ARVIN MERITOR BLUEBIRD SCHOOL BUS GREAT DANE TRAILER HENDRICKSON TRAILER SUSPENSION SYSTEMS INGERSOLL AXLES REYCO SUSPENSION SAF HOLLAND TUTHILL TECHNOLOGIES VOLVO WABASH NATIONAL WATSON & CHALIN MFG. INC.	No Req.	<b>85071</b>	CHEVROLET TRUCK (Ver también GMC) GMC TRUCK ISUZU	145054(2)
<b>85036</b>	BLUEBIRD SCHOOL BUS HENDRICKSON TRUCK SUSPENSION SYSTEMS MACK PETERBILT SPARTAN MOTORS VOLVO	No Req.	<b>85053</b>	WESTERN STAR	145126(2)	<b>85072</b>	HENDRICKSON TRUCK SUSPENSION SYSTEMS INTERNATIONAL (NAVISTAR) KENWORTH MACK MC NEILUS TRUCK & MAN. VOLVO	No Req.
<b>85040</b>	FORD STERLING TRUCK VOLVO	401754(4)	<b>85054</b>	FORD STERLING TRUCK	145080(2)	<b>85073</b>	VOLKSWAGEN	145089-000(1)
<b>85042</b>	FREIGHTLINER VOLVO	401754(4)	<b>85055</b>	FORD STERLING TRUCK	145080(2)	<b>85074</b>	VOLKSWAGEN	TR0027(4)
<b>85043</b>	FREIGHTLINER FREIGHTLINER CUSTOM CHASSIS HENDRICKSON TRAILER SUSPENSION SYSTEMS STERLING TRUCK	No Req.	<b>85058</b>	BLUEBIRD SCHOOL BUS FREIGHTLINER FREIGHTLINER CUSTOM CHASSIS INTERNATIONAL (NAVISTAR) OSHKOSH MOTORS PIERCE MANUFACTURING INC. THOMAS SCHOOL BUS VOLVO	No Req.	<b>85075</b>	VOLKSWAGEN	No Req.
<b>85045</b>	HENDRICKSON TRAILER SUSPENSION SYSTEMS INGERSOLL AXLES MUNCIE RECLAMATION REYCO SUSPENSION RIDEWELL CORPORATION SAF HOLLAND TUTHILL TECHNOLOGIES WABASH NATIONAL	No Req.	<b>85059</b>	RED LION TRAILER SAF HOLLAND STOUGHTON TRAILERS INC. TRAILMOBILE CANADA CORP. WABASH NATIONAL	No Req.	<b>85076</b>	VOLKSWAGEN	No Req.
<b>85046</b>	AUTOCAR VOLVO	140149(1)	<b>85060</b>	CHALMERS SUSPENSION FREIGHTLINER INTERNATIONAL (NAVISTAR) KENWORTH PETERBILT SAF HOLLAND VOLVO WATSON & CHALIN MFG. INC. WESTERN STAR	No Req.	<b>85077</b>	VOLKSWAGEN	TR0027(2)
<b>85047</b>	FORD KENWORTH	140149(1)	<b>85061</b>	MACK VOLVO	No Req.	<b>85078</b>	DANA WABASH NATIONAL	No Req.
			<b>85062</b>	KENWORTH PETERBILT VOLVO	145080(2)	<b>85079</b>	HENDRICKSON TRAILER SUSPENSION SYSTEMS MC NEILUS TRUCK & MAN.	No Req.
			<b>85063</b>	FORD MAECO STERLING TRUCK	145080(2)	<b>85080</b>	MACK VOLVO	145054(1)
			<b>85064</b>	GREAT DANE TRAILER HENDRICKSON TRAILER SUSPENSION SYSTEMS WATSON & CHALIN MFG. INC.	No Req.	<b>85081</b>	VOLVO	145090(1)
			<b>85065</b>	VOLVO	145128(1) & 145144(1)	<b>85082</b>	INTERNATIONAL (NAVISTAR)	No Req.
			<b>85066</b>	MACK VOLVO	No Req.	<b>85083</b>	HENDRICKSON TRUCK SUSPENSION SYSTEMS	145128(1)
			<b>85067</b>	KENWORTH	No Req.	<b>85084</b>	KENWORTH PETERBILT	No Req.
						<b>85085</b>	NISSAN	145054(2)
						<b>85086</b>	BLUEBIRD SCHOOL BUS REYCO SUSPENSION	No Req.
						<b>85087</b>	HENDRICKSON TRUCK SUSPENSION SYSTEMS MC NEILUS TRUCK & MAN.	No Req.
						<b>85088</b>	MACK VOLVO	No Req.
						<b>85089</b>	VOLVO	No Req.
						<b>85090</b>	BLUEBIRD SCHOOL BUS	No Req.
						<b>85091</b>	THOMAS SCHOOL BUS	No Req.
						<b>85092</b>	FREIGHTLINER CUSTOM CHASSIS	145054(1)
						<b>85093</b>	MERCEDES BENZ	145090(2)
						<b>85094</b>	VOLVO	No Req.
						<b>85095</b>	FREIGHTLINER MERCEDES BENZ	No Req.
						<b>85096</b>	FREIGHTLINER	145054(1)

# LISTA NUMÉRICA

Fleetline	APLICACIÓN	No. Kit	Fleetline	APLICACIÓN	No. Kit	Fleetline	APLICACIÓN	No. Kit
<b>85096</b>		<b>145054(1)</b>	<b>85301</b>		<b>401754(4)</b>	<b>85307</b>		<b>401754(4)</b>
MERCEDES BENZ			STERLING TRUCK			ACF BRILL BUS		
<b>85097</b>		No Req.	VOLVO			BECK BUS		
HOLIDAY RAMBLER			<b>85302</b>		<b>401754(4)</b>	BLUEBIRD SCHOOL BUS		
MONACO			AM GENERAL			BROCKWAY SCHOOL BUS		
SAF HOLLAND			CHEVROLET TRUCK (Ver también GMC)			BUS & TRUCK CO.		
<b>85098</b>		No Req.	CRANE CARRIER			CHEVROLET TRUCK (Ver también GMC)		
MACK			FORD			CLARK EQUIPMENT		
VOLVO			FREIGHTLINER			CONTINENTAL TRAILWAYS-EAGLE INT'L		
<b>85099</b>		No Req.	FWD TRUCK			CRANE CARRIER		
SAF HOLLAND			GILLIG BROS.			DIAMOND-REO		
<b>85100</b>		No Req.	GMC TRUCK			DINA		
DINA			KENWORTH			EAGLE MOTOR COACH		
VOLVO			MACK			FLXIBLE BUS		
<b>85102</b>		No Req.	MAECO			FORD		
HENDRICKSON TRUCK SUSPENSION SYSTEMS			MOTOR COACH INDUSTRIES			GMC TRUCK		
INTERNATIONAL (NAVISTAR)			PETERBILT			HENDRICKSON TRUCK SUSPENSION SYSTEMS		
<b>85103</b>		<b>145090(1)</b>	RIDEWELL CORPORATION			INTERNATIONAL (NAVISTAR)		
MERCEDES BENZ			VOLVO			MACK		
<b>85106</b>		No Req.	<b>85303</b>		<b>401754(4)</b>	MAECO		
BLUEBIRD SCHOOL BUS			ACF BRILL BUS			ONEIDA PRODUCTS		
<b>85107</b>		<b>141387(1)</b>	BROCKWAY SCHOOL BUS			ORION BUS INDUSTRIES		
DAIHATSU			BUS & TRUCK CO.			PIERCE MANUFACTURING INC.		
HINO			CHEVROLET TRUCK (Ver también GMC)			REYCO SUSPENSION		
MITSUBISHI			CONTINENTAL TRAILWAYS-EAGLE INT'L			RIDEWELL CORPORATION		
<b>85108</b>		No Req.	CRANE CARRIER			SPARTAN MOTORS		
FREIGHTLINER			CROWN COACH			THOMAS SCHOOL BUS		
MERCEDES BENZ			EAGLE MOTOR COACH			VOLVO		
<b>85109</b>	N	No Req.	GMC TRUCK			WESTERN STAR		
KENWORTH			GREYHOUND BUS			WESTERN UNIT "STABILAIRE" SUSPENSION		
SAF HOLLAND			HENDRICKSON TRUCK SUSPENSION SYSTEMS			<b>85308</b>		<b>401754(4)</b>
<b>85110</b>		<b>145090(2)</b>	INTERNATIONAL (NAVISTAR)			ACF BRILL BUS		
M.A.N.			KENWORTH			CHEVROLET TRUCK (Ver también GMC)		
<b>85117</b>	C	<b>145090(2)</b>	MACK			EAGLE MOTOR COACH		
MERCEDES BENZ			MAECO			FREIGHTLINER		
<b>85118</b>	C	<b>145177(2)</b>	MATSON SCHOOL BUS			GMC TRUCK		
HINO			MC NEILUS TRUCK & MAN.			HAULMARK		
<b>85119</b>	C	No Req.	MOHAWK			HINO		
KENWORTH			MOTOR COACH INDUSTRIES			INTERNATIONAL (NAVISTAR)		
PETERBILT			ORION BUS INDUSTRIES			KENWORTH		
<b>85120</b>	C	No Req.	OSHKOSH MOTORS			MACK		
MACK			OTTAWA TRUCK			MAECO		
<b>85121</b>	C	No Req.	PETERBILT			MITSUBISHI-FUSO		
VOLVO			PREVOST			MOHAWK		
<b>85122</b>	C	<b>145089-000(1)</b>	TRANSPORTATION MFG. CORP			NISSAN		
FREIGHTLINER CUSTOM CHASSIS			VOLVO			ORION BUS INDUSTRIES		
THOMAS SCHOOL BUS			WESTERN STAR			PETERBILT		
<b>85123</b>	C	<b>145090(1)</b>	<b>85304</b>		<b>401754(4)</b>	PREVOST		
FREIGHTLINER			BECK BUS			THOMAS SCHOOL BUS		
<b>85300</b>		<b>401754(4)</b>	BLUEBIRD SCHOOL BUS			VOLVO		
CHEVROLET TRUCK (Ver también GMC)			BROCKWAY SCHOOL BUS			WESTERN STAR		
FREIGHTLINER			CHEVROLET TRUCK (Ver también GMC)			WESTERN UNIT "STABILAIRE" SUSPENSION		
FRUEHAUF			CONTINENTAL TRAILWAYS-EAGLE INT'L			<b>85310</b>		<b>141108(1)</b>
GMC TRUCK			CRANE CARRIER			INTERNATIONAL (NAVISTAR)		
GRANNING SUSPENSION			CROWN COACH			KENWORTH		
HOBBS TRAILERS			DIAMOND-REO			MACK		
INTERNATIONAL (NAVISTAR)			DIAMOND T			OTTAWA TRUCK		
MAECO			EAGLE MOTOR COACH			PETERBILT		
MUNCIE RECLAMATION			FLXIBLE BUS			VOLVO		
OSHKOSH MOTORS			FORD			<b>85311</b>		<b>141247(1)</b>
OSTERLUND TRUCK			FRUEHAUF			FLXIBLE BUS		
OTTAWA TRUCK			GILLIG BROS.			INTERNATIONAL (NAVISTAR)		
PIERCE MANUFACTURING INC.			GMC TRUCK			KENWORTH		
REYCO SUSPENSION			MACK			MACK		
SAF HOLLAND			OSHKOSH MOTORS			PETERBILT		
SEAGRAVE FIRE APPARATUS LLC			PIERCE MANUFACTURING INC.			VOLVO		
TUTHILL TECHNOLOGIES			RIDEWELL CORPORATION			<b>85312</b>		<b>141247(1)</b>
VOLVO			SAF HOLLAND			MOTOR COACH INDUSTRIES		
WABASH NATIONAL			SOUTHERN COACH			TRANSPORTATION MFG. CORP		
WATSON & CHALIN MFG. INC.			SPARTAN MOTORS			<b>85313</b>		<b>401754(4)</b>
WESTERN UNIT "STABILAIRE" SUSPENSION			THOMAS SCHOOL BUS			FLXIBLE BUS		
<b>85301</b>		<b>401754(4)</b>	UNITED MANUFACTURING			GMC TRUCK		
BECK BUS			VOLVO			GREYHOUND BUS		
CHALMERS SUSPENSION			WESTERN STAR			MAECO		
CHEVROLET TRUCK (Ver también GMC)			WESTERN UNIT "STABILAIRE" SUSPENSION			MOTOR COACH INDUSTRIES		
CLARK EQUIPMENT			<b>85305</b>		<b>401754(4)</b>	NOVA BUS		
FLXIBLE BUS			BROCKWAY SCHOOL BUS			REYCO SUSPENSION		
FORD			BUS & TRUCK CO.			TRANSPORTATION MFG. CORP		
FREIGHTLINER			CHEVROLET TRUCK (Ver también GMC)			TUTHILL TECHNOLOGIES		
GMC TRUCK			CONTINENTAL TRAILWAYS-EAGLE INT'L			<b>85314</b>		<b>401754(4)</b>
HENDRICKSON TRAILER SUSPENSION SYSTEMS			EAGLE MOTOR COACH			CHALMERS SUSPENSION		
SAF HOLLAND			FLXIBLE BUS			EAGLE MOTOR COACH		
			FORD			FORD		
			FRUEHAUF			KENWORTH		
			GMC TRUCK			MAECO		
			HENDRICKSON TRUCK SUSPENSION SYSTEMS			PETERBILT		
			MACK			STERLING TRUCK		
			MAECO			VOLVO		
			MC NEILUS TRUCK & MAN.			<b>85315</b>		<b>401754(4)</b>
			MOHAWK			CLARK EQUIPMENT		
			PAI CORP			CUNHA PRODUCTS OHD		
			RIDEWELL CORPORATION			FORD		
			VOLVO			JIFFLOX		
			WESTERN STAR					
			WESTERN UNIT "STABILAIRE" SUSPENSION					

C = Próximo Lanzamiento, N = Nuevo



# LISTA NUMÉRICA

Fleetline	APLICACIÓN	No. Kit	Fleetline	APLICACIÓN	No. Kit	Fleetline	APLICACIÓN	No. Kit
<b>85315</b>	KWK-LOC (JIFFLOX) VOLVO WESTERN STAR	<b>401754(4)</b>	<b>85336</b>	ISUZU PETERBILT	<b>145054(2)</b>	<b>85702</b>	CHEVROLET TRUCK (Ver también GMC) FLXIBLE BUS GMC TRUCK HAUSMAN MOHAWK MOTOR COACH INDUSTRIES MUNCIE RECLAMATION NOVA BUS PREVOST REYCO SUSPENSION RIDEWELL CORPORATION TRANSPORTATION MFG. CORP TUTHILL TECHNOLOGIES VOLVO	<b>401754(4)</b>
<b>85316</b>	INTERNATIONAL (NAVISTAR) MACK MAECO OSHKOSH MOTORS PIERCE MANUFACTURING INC. VOLVO	<b>145090(1)</b>	<b>85337</b>	HENDRICKSON TRAILER SUSPENSION SYSTEMS	<b>No Req.</b>	<b>85703</b>	FLXIBLE BUS GRUMMAN BUS MOHAWK MUNCIE RECLAMATION VOLVO	<b>141247(1) &amp; 401754(2)</b>
<b>85318</b>	GILLIG BROS. HAUSMAN VOLVO	<b>145054(2)</b>	<b>85338</b>	HENDRICKSON TRAILER SUSPENSION SYSTEMS	<b>No Req.</b>	<b>85704</b>	ARVIN MERITOR CHEVROLET TRUCK (Ver también GMC) FLXIBLE BUS GMC TRUCK GRUMMAN BUS MOHAWK MOTOR COACH INDUSTRIES MUNCIE RECLAMATION REYCO SUSPENSION RIDEWELL CORPORATION TUTHILL TECHNOLOGIES VOLVO	<b>401754(4)</b>
<b>85319</b>	FREIGHTLINER INTERNATIONAL (NAVISTAR) KENWORTH MACK PETERBILT VOLVO	<b>145089-000(1)</b>	<b>85339</b>	MAECO MOTOR COACH INDUSTRIES TRANSPORTATION MFG. CORP	<b>401754(4)</b>	<b>85705</b>	FLXIBLE BUS INTERNATIONAL (NAVISTAR) MUNCIE RECLAMATION NEOPLAN BUS VOLVO	<b>145090(2)</b>
<b>85320</b>	FREIGHTLINER KENWORTH MAECO PETERBILT VOLVO	<b>401754(4)</b>	<b>85340</b>	MOTOR COACH INDUSTRIES	<b>145089-000(1)</b>	<b>85706</b>	HAUSMAN NEOPLAN BUS VOLVO	<b>145090(2)</b>
<b>85321</b>	ARVIN MERITOR FRUEHAUF HOLLAND - BINKLEY MACK SAF HOLLAND WABASH NATIONAL WATSON & CHALIN MFG. INC.	<b>No Req.</b>	<b>85341</b>	MOTOR COACH INDUSTRIES	<b>145089-000(1)</b>	<b>85707</b>	ARVIN MERITOR FLXIBLE BUS MOHAWK MOTOR COACH INDUSTRIES MUNCIE RECLAMATION NEOPLAN BUS	<b>145090(2)</b>
<b>85322</b>	FRUEHAUF VOLVO WABASH NATIONAL	<b>401754(2)</b>	<b>85342</b>	CHEVROLET TRUCK (Ver también GMC) GMC TRUCK	<b>145054(2)</b>	<b>85708</b>	ABC BUS ARVIN MERITOR CHEVROLET TRUCK (Ver también GMC) FLXIBLE BUS FLYER INDUSTRIES GILLIG BROS. GMC TRUCK M.A.N. MOTOR COACH INDUSTRIES MUNCIE RECLAMATION NEW FLYER PREVOST VAN HOOL VOLVO	<b>145090(2)</b>
<b>85323</b>	EAST MANUFACTURING CORP. GREAT DANE TRAILER HENDRICKSON TRAILER SUSPENSION SYSTEMS INGERSOLL AXLES KENWORTH MC NEILUS TRUCK & MAN. SAF HOLLAND VOLVO WABASH NATIONAL WATSON & CHALIN MFG. INC.	<b>No Req.</b>	<b>85343</b>	KENWORTH PETERBILT	<b>145089-000(1) &amp; 401754(2)</b>	<b>85709</b>	M.A.N. MUNCIE RECLAMATION VOLVO	<b>145090(2)</b>
<b>85324</b>	CHAMPION TRANSIT CHEVROLET TRUCK (Ver también GMC) GMC TRUCK ISUZU MERCEDES BENZ	<b>145054(2)</b>	<b>85344</b>	HENDRICKSON TRAILER SUSPENSION SYSTEMS WATSON & CHALIN MFG. INC.	<b>No Req.</b>	<b>85710</b>	CHEVROLET TRUCK (Ver también GMC) FLXIBLE BUS GMC TRUCK MOTOR COACH INDUSTRIES MUNCIE RECLAMATION NEW FLYER NOVA BUS PREVOST TRANSPORTATION MFG. CORP	<b>141247(1) &amp; 401754(2)</b>
<b>85327</b>	FRUEHAUF	<b>401754(2)</b>	<b>85345</b>	HENDRICKSON TRAILER SUSPENSION SYSTEMS MC NEILUS TRUCK & MAN.	<b>No Req.</b>	<b>85711</b>	CHEVROLET TRUCK (Ver también GMC) FLXIBLE BUS FLYER INDUSTRIES MAECO MOTOR COACH INDUSTRIES MUNCIE RECLAMATION NEW FLYER ORION BUS INDUSTRIES TRANSPORTATION MFG. CORP VOLVO	<b>141247(1) &amp; 401754(2)</b>
<b>85329</b>	ARVIN MERITOR BLUEBIRD SCHOOL BUS PREVOST	<b>401754(4)</b>	<b>85346</b>	NEW FLYER	<b>145090(2)</b>			
<b>85330</b>	PREVOST	<b>145054(1)</b>	<b>85347</b>	NEW FLYER	<b>145090(2)</b>			
<b>85331</b>	FREIGHTLINER FREIGHTLINER CUSTOM CHASSIS WESTERN STAR	<b>No Req.</b>	<b>85376</b>	FORD STERLING TRUCK	<b>401754(4)</b>			
<b>85332</b>	IC CORPORATION INTERNATIONAL (NAVISTAR)	<b>145128(1)</b>	<b>85377</b>	NOVA BUS	<b>No Req.</b>			
<b>85333</b>	INTERNATIONAL (NAVISTAR)	<b>145128(1)</b>	<b>85378</b>	NOVA BUS PREVOST	<b>No Req.</b>			
<b>85334</b>	ADVANCE MIXER MAECO MC NEILUS TRUCK & MAN. REYCO SUSPENSION	<b>401754(4)</b>	<b>85379</b>	PREVOST	<b>145054(1)</b>			
<b>85335</b>	FREIGHTLINER	<b>No Req.</b>	<b>85380</b>	PREVOST	<b>145090(1) &amp; 401754(2)</b>			
<b>85336</b>	CHEVROLET TRUCK (Ver también GMC) GMC TRUCK	<b>145054(2)</b>	<b>85381</b>	VOLVO	<b>No Req.</b>			
			<b>85382</b>	HENDRICKSON TRAILER SUSPENSION SYSTEMS	<b>No Req.</b>			
			<b>85700</b>	ABC BUS AM GENERAL ARVIN MERITOR CHEVROLET TRUCK (Ver también GMC) FLXIBLE BUS FLYER INDUSTRIES GMC TRUCK GREYHOUND BUS GRUMMAN BUS JAY MADSEN KENWORTH MOHAWK MOTOR COACH INDUSTRIES MUNCIE RECLAMATION NOVA BUS ORION BUS INDUSTRIES PREVOST SICARD TRANSPORTATION MFG. CORP VOLVO	<b>401754(4)</b>			
			<b>85701</b>	CHEVROLET TRUCK (Ver también GMC)	<b>145054(2)</b>			

# LISTA NUMÉRICA

Fleetline	APLICACIÓN	No. Kit	Fleetline	APLICACIÓN	No. Kit	Fleetline	APLICACIÓN	No. Kit
<b>85712</b>	ARVIN MERITOR BLUEBIRD SCHOOL BUS CARPENTER BUS DIAMOND-REO FLUIDRIVE FLXIBLE BUS FORD GILLIG BROS. GRANNING SUSPENSION HENDRICKSON TRAILER SUSPENSION SYSTEMS MERITOR ORION BUS INDUSTRIES OSTERLUND TRUCK RAYDAN MANUFACTURING RIDEWELL CORPORATION SPARTAN MOTORS THOMAS SCHOOL BUS TUTHILL TECHNOLOGIES VOLVO	<b>401754(4)</b>	<b>85729</b>	PREVOST UNIVERSAL COACH	<b>145054(1) &amp; 401754(2)</b>	<b>85900</b>	PETERBILT THOR MOTOR COACH WINNEBAGO	<b>145054(2)</b>
<b>85713</b>	CARPENTER BUS CRANE CARRIER EAGLE MOTOR COACH MOTOR COACH INDUSTRIES MUNCIE RECLAMATION NOVA BUS PREVOST THOMAS SCHOOL BUS TRANSPORTATION MFG. CORP	<b>401754(4)</b>	<b>85730</b>	FLXIBLE BUS VOLVO	<b>401754(4)</b>	<b>85901</b>	FREIGHTLINER KENWORTH PETERBILT RIDEWELL CORPORATION	<b>401754(4)</b>
<b>85714</b>	MOHAWK ORION BUS INDUSTRIES	<b>145093(1)</b>	<b>85731</b>	FLXIBLE BUS	<b>145054(1) &amp; 401754(2)</b>	<b>85902</b>	KENWORTH PETERBILT	<b>145054(2)</b>
<b>85715</b>	MOHAWK ORION BUS INDUSTRIES	<b>145093(1)</b>	<b>85732</b>	ABC BUS ORION BUS INDUSTRIES	<b>145116(2)</b>	<b>85903</b>	HENDRICKSON TRUCK SUSPENSION SYSTEMS	<b>No Req.</b>
<b>85716</b>	DINA FLXIBLE BUS FORD GILLIG BROS. MAECO ORION BUS INDUSTRIES VOLVO	<b>145093(1)</b>	<b>85733</b>	ABC BUS CHEVROLET TRUCK (Ver también GMC) EAGLE MOTOR COACH FLXIBLE BUS GMC TRUCK MOHAWK MOTOR COACH INDUSTRIES NOVA BUS TRANSPORTATION MFG. CORP VOLVO	<b>145089-000(1)</b>	<b>85904</b>	FREIGHTLINER CUSTOM CHASSIS HENDRICKSON TRUCK SUSPENSION SYSTEMS LINK MANUFACTURING LTD. STERLING TRUCK	<b>No Req.</b>
<b>85717</b>	MOHAWK ORION BUS INDUSTRIES REYCO SUSPENSION TUTHILL TECHNOLOGIES	<b>145093(1)</b>	<b>85734</b>	BLUEBIRD SCHOOL BUS CHEVROLET TRUCK (Ver también GMC) CROWN COACH FLXIBLE BUS GILLIG BROS. GMC TRUCK INTERNATIONAL (NAVISTAR) LINK MANUFACTURING LTD. OSHKOSH MOTORS RIDEWELL CORPORATION SAF HOLLAND VOLVO	<b>401754(4)</b>	<b>85905</b>	SAF HOLLAND	<b>401754(2)</b>
<b>85718</b>	FLXIBLE BUS MOHAWK ORION BUS INDUSTRIES	<b>145093(1)</b>	<b>85735</b>	ABC BUS CHEVROLET TRUCK (Ver también GMC) EAGLE MOTOR COACH GMC TRUCK GREYHOUND BUS MOTOR COACH INDUSTRIES PACIFIC TRUCK & TRAILER PREVOST TRANSPORTATION MFG. CORP VOLVO WESTERN UNIT "STABILAIRE" SUSPENSION	<b>401754(4)</b>	<b>85906</b>	FORD KENWORTH MACK MC NEILUS TRUCK & MAN. PETERBILT SAF HOLLAND STERLING TRUCK VOLVO WESTERN STAR	<b>No Req.</b>
<b>85719</b>	ORION BUS INDUSTRIES	<b>145093(1)</b>	<b>85736</b>	BLUEBIRD SCHOOL BUS FLXIBLE BUS MOHAWK PREVOST RIDEWELL CORPORATION THOMAS SCHOOL BUS VOLVO	<b>401754(4)</b>	<b>85907</b>	SAF HOLLAND	<b>No Req.</b>
<b>85720</b>	ORION BUS INDUSTRIES OTTAWA TRUCK	<b>401754(4)</b>	<b>85737</b>	MERITOR SUSPENSYS	<b>No Req.</b>	<b>85908</b>	SAF HOLLAND	<b>No Req.</b>
<b>85722</b>	ARVIN MERITOR FLYER INDUSTRIES GILLIG BROS. GMC TRUCK M.A.N. MUNCIE RECLAMATION NEW FLYER VOLVO	<b>145090(2)</b>	<b>85738</b>	EAST MANUFACTURING CORP. HENDRICKSON TRAILER SUSPENSION SYSTEMS MC NEILUS TRUCK & MAN. REYCO SUSPENSION TUTHILL TECHNOLOGIES	<b>No Req.</b>	<b>85909</b>	FORD HENDRICKSON TRUCK SUSPENSION SYSTEMS KENWORTH MACK MC NEILUS TRUCK & MAN. ROADMASTER (MONACO) SAF HOLLAND	<b>No Req.</b>
<b>85723</b>	GILLIG BROS. MOTOR COACH INDUSTRIES MUNCIE RECLAMATION VOLVO	<b>145075(1)</b>	<b>85739</b>	INTERNATIONAL (NAVISTAR) MACK MERITOR RAYDAN MANUFACTURING	<b>No Req.</b>	<b>85910</b>	BLUEBIRD SCHOOL BUS FREIGHTLINER KENWORTH PETERBILT ROADMASTER (MONACO) SAF HOLLAND	<b>No Req.</b>
<b>85724</b>	FREIGHTLINER STERLING TRUCK THOMAS SCHOOL BUS WESTERN STAR	<b>No Req.</b>	<b>85740</b>	MAECO MOTOR COACH INDUSTRIES	<b>145090(1) &amp; 401754(2)</b>	<b>85911</b>	HENDRICKSON TRAILER SUSPENSION SYSTEMS SAF HOLLAND	<b>No Req.</b>
<b>85727</b>	ABC BUS MOTOR COACH INDUSTRIES	<b>145140(2) &amp; 405360(2)</b>	<b>85745</b>	C	<b>145090(2)</b>	<b>85912</b>	SAF HOLLAND	<b>401754(2)</b>
<b>85728</b>	MOTOR COACH INDUSTRIES PREVOST	<b>145140(2)</b>	<b>85746</b>	C	<b>145090(2)</b>	<b>85913</b>	RED LION TRAILER SAF HOLLAND	<b>401754(2)</b>
<b>85729</b>	ABC BUS MOTOR COACH INDUSTRIES ORION BUS INDUSTRIES	<b>145054(1) &amp; 401754(2)</b>	<b>85900</b>	COACHMEN RV FLEETWOOD RV FOREST RIVER INC FREIGHTLINER CUSTOM CHASSIS GULF STREAM COACH ITASCA KENWORTH KING OF THE ROAD MANDALAY COACH NEWMAR CORP	<b>145054(2)</b>	<b>85914</b>	BLUEBIRD SCHOOL BUS SAF HOLLAND	<b>No Req.</b>
						<b>85916</b>	HENDRICKSON TRAILER SUSPENSION SYSTEMS MC NEILUS TRUCK & MAN. SAF HOLLAND	<b>No Req.</b>
						<b>85918</b>	FREIGHTLINER FREIGHTLINER CUSTOM CHASSIS THOMAS SCHOOL BUS	<b>No Req.</b>
						<b>85919</b>	BLUEBIRD SCHOOL BUS FREIGHTLINER FREIGHTLINER CUSTOM CHASSIS GREAT DANE TRAILER HENDRICKSON TRUCK SUSPENSION SYSTEMS MC NEILUS TRUCK & MAN. MERITOR WABASH NATIONAL WORKHORSE	<b>No Req.</b>
						<b>85920</b>	FREIGHTLINER KENWORTH PETERBILT	<b>No Req.</b>

C = Próximo Lanzamiento

## LISTA NUMÉRICA

Fleetline	APLICACIÓN	No. Kit	Fleetline	APLICACIÓN	No. Kit	Fleetline	APLICACIÓN	No. Kit
85920	STERLING TRUCK	No Req.	85947	VOLKSWAGEN	No Req.	85975	SAF HOLLAND	No Req.
85921	FREIGHTLINER	145054(1)	85948	VOLKSWAGEN	401754(4)	85976	BLUEBIRD SCHOOL BUS HENDRICKSON TRUCK SUSPENSION SYSTEMS INTERNATIONAL (NAVISTAR) MC NEILUS TRUCK & MAN. VOLVO WESTERN STAR	No Req.
85923	INTERNATIONAL (NAVISTAR)	No Req.	85949	VOLKSWAGEN	401754(4)	85977	HENDRICKSON TRUCK SUSPENSION SYSTEMS MC NEILUS TRUCK & MAN.	145128(1)
85924	INTERNATIONAL (NAVISTAR)	No Req.	85950	VOLKSWAGEN	No Req.	85978	HENDRICKSON TRUCK SUSPENSION SYSTEMS MACK VOLVO	No Req.
85925	INTERNATIONAL (NAVISTAR)	No Req.	85951	VOLKSWAGEN	401754(4)	85979	HENDRICKSON TRUCK SUSPENSION SYSTEMS MC NEILUS TRUCK & MAN. WESTERN STAR	No Req.
85926	FORD IC CORPORATION INTERNATIONAL (NAVISTAR) STERLING TRUCK	No Req.	85953	INTERNATIONAL (NAVISTAR)	No Req.	85980	HENDRICKSON TRUCK SUSPENSION SYSTEMS MC NEILUS TRUCK & MAN.	No Req.
85927	FORD INTERNATIONAL (NAVISTAR)	No Req.	85954	INTERNATIONAL (NAVISTAR)	No Req.	85981	MERCEDES BENZ	145168(1)
85928	FORD INTERNATIONAL (NAVISTAR)	No Req.	85955	HENDRICKSON TRUCK SUSPENSION SYSTEMS INTERNATIONAL (NAVISTAR)	No Req.	85982	ARVIN MERITOR M.A.N. MUNCIE RECLAMATION	145090(2)
85929	INTERNATIONAL (NAVISTAR)	No Req.	85956	FREIGHTLINER STERLING TRUCK VOLVO WESTERN STAR	No Req.	85983	DINA	401754(4)
85930	INTERNATIONAL (NAVISTAR)	No Req.	85957	INTERNATIONAL (NAVISTAR) STERLING TRUCK	No Req.	85984	FREIGHTLINER	No Req.
85931	INTERNATIONAL (NAVISTAR)	No Req.	85958	FREIGHTLINER WESTERN STAR	No Req.	85985	KENWORTH PETERBILT	145089-200(1)
85932	FREIGHTLINER HENDRICKSON TRUCK SUSPENSION SYSTEMS MC NEILUS TRUCK & MAN. STERLING TRUCK WESTERN STAR	No Req.	85959	BLUEBIRD SCHOOL BUS FREIGHTLINER FREIGHTLINER CUSTOM CHASSIS HENDRICKSON TRUCK SUSPENSION SYSTEMS MC NEILUS TRUCK & MAN. PETERBILT SPARTAN MOTORS STERLING TRUCK	No Req.	85986	HENDRICKSON TRUCK SUSPENSION SYSTEMS IC CORPORATION	No Req.
85933	HENDRICKSON TRUCK SUSPENSION SYSTEMS MACK MC NEILUS TRUCK & MAN. VOLVO	No Req.	85961	HENDRICKSON TRUCK SUSPENSION SYSTEMS	No Req.	85988	KENWORTH PETERBILT	145099(1)
85934	MAECO RIDEWELL CORPORATION WATSON & CHALIN MFG. INC.	No Req.	85962	HENDRICKSON TRUCK SUSPENSION SYSTEMS MC NEILUS TRUCK & MAN.	No Req.	85989	KENWORTH PETERBILT	No Req.
85935	INTERNATIONAL (NAVISTAR)	145090(1)	85963	INTERNATIONAL (NAVISTAR)	No Req.	85993	C MERCEDES BENZ	145090(1)
85936	KENWORTH PETERBILT	145089-200(1)	85964	INTERNATIONAL (NAVISTAR)	No Req.	85994	C INTERNATIONAL (NAVISTAR)	No Req.
85937	KENWORTH PETERBILT	145089-200(1)	85965	HENDRICKSON TRUCK SUSPENSION SYSTEMS KENWORTH MC NEILUS TRUCK & MAN.	No Req.	85995	C INTERNATIONAL (NAVISTAR)	No Req.
85938	ARVIN MERITOR HENDRICKSON TRAILER HENDRICKSON TRAILER SUSPENSION SYSTEMS INGERSOLL AXLES REYCO SUSPENSION TUTHILL TECHNOLOGIES WATSON & CHALIN MFG. INC.	No Req.	85966	HENDRICKSON TRUCK SUSPENSION SYSTEMS KENWORTH MC NEILUS TRUCK & MAN.	No Req.	85996	C PETERBILT	145168-000(2)
85939	ARVIN MERITOR HENDRICKSON TRAILER SUSPENSION SYSTEMS TIMBREN INDUSTRIES WATSON & CHALIN MFG. INC.	No Req.	85967	HENDRICKSON TRUCK SUSPENSION SYSTEMS KENWORTH MC NEILUS TRUCK & MAN.	No Req.	85997	C PETERBILT	145168-000(2)
85940	VOLKSWAGEN	401754(4)	85968	GILLIG BROS. SAF HOLLAND	401754(4)	85998	C INTERNATIONAL (NAVISTAR)	No Req.
85941	VOLKSWAGEN	401754(4)	85969	INTERNATIONAL (NAVISTAR)	No Req.	85999	C INTERNATIONAL (NAVISTAR)	No Req.
85942	VOLKSWAGEN	401754(4)	85970	MOTOR COACH INDUSTRIES	145089-000(1)	86200	MERITOR	No Req.
85943	VOLKSWAGEN	401754(4)	85971	BLUEBIRD SCHOOL BUS	No Req.	86201	MERITOR	No Req.
85944	VOLKSWAGEN	401754(4)	85972	MACK	No Req.	86202	MERITOR	No Req.
85945	VOLKSWAGEN	No Req.	85973	MERCEDES BENZ	145090(1)	86203	MERITOR	No Req.
85946	VOLKSWAGEN	No Req.	85974	SAF HOLLAND	No Req.	87015	EAST MANUFACTURING CORP. MERITOR	No Req.
			85975	BLUEBIRD SCHOOL BUS REYCO SUSPENSION	No Req.	87016	145116(1) & 145090(1) ORION BUS INDUSTRIES	
						87017	BLUEBIRD SCHOOL BUS OPTIMA BUS CORP	No Req.

# LISTA NUMÉRICA

Fleetline	APLICACIÓN	No. Kit	Fleetline	APLICACIÓN	No. Kit	Fleetline	APLICACIÓN	No. Kit
<b>87017</b>	RIDEWELL CORPORATION	No Req.	<b>89407</b>	CHANCE BUS CHEVROLET TRUCK (Ver también GMC) DURA SUSPENSION EAST MANUFACTURING CORP. FORD GILLIG BROS. GMC TRUCK GREAT DANE TRAILER HARDEE MFG HENDRICKSON TRUCK SUSPENSION SYSTEMS HIGHWAY PRODUCT INTERNATIONAL (NAVISTAR) KENWORTH MACK MAECO MC NEILUS TRUCK & MAN. MOHAWK NATIONAL COACH CORP OSHKOSH MOTORS PETERBILT REYCO SUSPENSION RIDEWELL CORPORATION SAF HOLLAND STERLING TRUCK TRAILMOBILE CANADA CORP. TUTHILL TECHNOLOGIES TWIN COACH VOLVO WABASH NATIONAL WESTERN STAR	No Req.	<b>89414</b>	MC NEILUS TRUCK & MAN. PETERBILT REYCO SUSPENSION SAF HOLLAND SPARTAN MOTORS STERLING TRUCK TRAILMOBILE CANADA CORP. TUTHILL TECHNOLOGIES VOLVO WESTERN STAR	No Req.
<b>87018</b>	HENDRICKSON TRAILER SUSPENSION SYSTEMS	No Req.	<b>89408</b>	KENWORTH PETERBILT VOLVO	145080(2)	<b>89415</b>	INTERNATIONAL (NAVISTAR) KENWORTH MACK PETERBILT VOLVO	140149(1)
<b>87019</b>	NOVA BUS	No Req.	<b>89409</b>	FORD KENWORTH OSHKOSH MOTORS PETERBILT PIERCE MANUFACTURING INC. VOLVO	140149(1)	<b>89416</b>	AUTOCAR INTERNATIONAL (NAVISTAR) MACK VOLVO	140149(1)
<b>87020</b>	SCANIA	145090(1)	<b>89410</b>	FORD INTERNATIONAL (NAVISTAR) KENWORTH MACK MAECO PETERBILT REYCO SUSPENSION STERLING TRUCK TUTHILL TECHNOLOGIES VOLVO	401754(4)	<b>89417</b>	AUTOCAR GMC TRUCK VOLVO	145054(1)
<b>89402</b>	VOLVO	140149(1)	<b>89411</b>	INTERNATIONAL (NAVISTAR) KENWORTH MARMON PETERBILT VOLVO	No Req.	<b>89418</b>	AUTOCAR INTERNATIONAL (NAVISTAR) VOLVO	145054(2)
<b>89414</b>	MAECO	No Req.	<b>89412</b>	FREIGHTLINER KENWORTH MACK PETERBILT REYCO SUSPENSION SPARTAN MOTORS TUTHILL TECHNOLOGIES VOLVO	401754(4)	<b>89419</b>	CHEVROLET TRUCK (Ver también GMC) FREIGHTLINER FRUEHAUF GMC TRUCK GRANNING SUSPENSION HOBBS TRAILERS INTERNATIONAL (NAVISTAR) MUNCIE RECLAMATION OSHKOSH MOTORS OSTERLUND TRUCK OTTAWA TRUCK PIERCE MANUFACTURING INC. REYCO SUSPENSION SAF HOLLAND SEAGRAVE FIRE APPARATUS LLC TUTHILL TECHNOLOGIES VOLVO WABASH NATIONAL WATSON & CHALIN MFG. INC. WESTERN UNIT "STABILAIRE" SUSPENSION	401754(4)
<b>89440</b>	MAECO	No Req.	<b>89413</b>	ARVIN MERITOR BLUEBIRD SCHOOL BUS BROCKWAY SCHOOL BUS CHANCE COACH CHEVROLET TRUCK (Ver también GMC) FORD GMC TRUCK INTERNATIONAL (NAVISTAR) ISUZU KENWORTH PETERBILT VOLVO	145080(2)	<b>89420</b>	AM GENERAL CHEVROLET TRUCK (Ver también GMC) CRANE CARRIER FORD FREIGHTLINER FWD TRUCK GILLIG BROS. GMC TRUCK KENWORTH MACK MAECO MOTOR COACH INDUSTRIES PETERBILT RIDEWELL CORPORATION VOLVO	401754(4)
<b>89447</b>	MUNCIE RECLAMATION	141108(1)	<b>89414</b>	BLUEBIRD SCHOOL BUS CHEVROLET TRUCK (Ver también GMC) COUNTRY COACH FORD FREIGHTLINER FRUEHAUF GILLIG BROS. GMC TRUCK GREAT DANE TRAILER HENDRICKSON TRUCK SUSPENSION SYSTEMS ISUZU KENWORTH LODAL, INC. MACK MAECO MARMON MC NEILUS TRUCK & MAN. OSHKOSH MOTORS PETERBILT REYCO SUSPENSION SAF HOLLAND TUTHILL TECHNOLOGIES VOLVO WESTERN STAR	No Req.	<b>89422</b>	ACF BRILL BUS BROCKWAY SCHOOL BUS BUS & TRUCK CO. CHEVROLET TRUCK (Ver también GMC) CONTINENTAL TRAILWAYS-EAGLE INT'L CRANE CARRIER CROWN COACH EAGLE MOTOR COACH FREIGHTLINER GMC TRUCK GREYHOUND BUS HAULMARK HENDRICKSON TRUCK SUSPENSION SYSTEMS HINO INTERNATIONAL (NAVISTAR) KENWORTH MACK MAECO MATSON SCHOOL BUS MC NEILUS TRUCK & MAN. MITSUBISHI-FUSO MOHAWK MOTOR COACH INDUSTRIES NISSAN ORION BUS INDUSTRIES	
<b>695406</b>	ABC BUS ARVIN MERITOR VAN HOOL	145090(2)	<b>89415</b>	ADVANCE MIXER BENSON TRUCK BODIES INC. BLUEBIRD SCHOOL BUS BROCKWAY SCHOOL BUS	No Req.			

## Aplicaciones GasSLX

# LISTA NUMÉRICA

Fleetline	APLICACIÓN	No. Kit	Fleetline	APLICACIÓN	No. Kit	Fleetline	APLICACIÓN	No. Kit
<b>89422</b>	OSHKOSH MOTORS OTTAWA TRUCK PETERBILT PREVOST THOMAS SCHOOL BUS TRANSPORTATION MFG. CORP VOLVO WESTERN STAR WESTERN UNIT "STABILAIRE" SUSPENSION	<b>401754(4)</b>	<b>89431</b>	THOMAS SCHOOL BUS VOLVO	<b>No Req.</b>	<b>89443</b>	WESTERN STAR	<b>No Req.</b>
<b>89423</b>	INTERNATIONAL (NAVISTAR) KENWORTH MACK OTTAWA TRUCK PETERBILT VOLVO	<b>141108(1)</b>	<b>89432</b>	KENWORTH MAECO VOLVO	<b>No Req.</b>	<b>89446</b>	FORD INTERNATIONAL (NAVISTAR) STERLING TRUCK VOLVO	<b>TR0027(4)</b>
<b>89424</b>	FLXIBLE BUS INTERNATIONAL (NAVISTAR) KENWORTH MACK PETERBILT VOLVO	<b>141247(1)</b>	<b>89434</b>	AUTOCAR VOLVO	<b>140149(1)</b>	<b>89447</b>	BLUEBIRD SCHOOL BUS FLXIBLE BUS IC CORPORATION INTERNATIONAL (NAVISTAR) MITSUBISHI-FUSO MUNCIE RECLAMATION NEOPLAN BUS VOLVO	<b>141108(1)</b>
<b>89425</b>	CHALMERS SUSPENSION EAGLE MOTOR COACH FORD KENWORTH MAECO PETERBILT STERLING TRUCK VOLVO	<b>401754(4)</b>	<b>89435</b>	FORD KENWORTH PETERBILT STERLING TRUCK VOLVO	<b>140149(1)</b>	<b>89448</b>	MACK VOLVO	<b>No Req.</b>
<b>89426</b>	INTERNATIONAL (NAVISTAR) MACK MAECO OSHKOSH MOTORS PIERCE MANUFACTURING INC. VOLVO	<b>145090(1)</b>	<b>89436</b>	ARVIN MERITOR BENSON TRUCK BODIES INC. CHANCE BUS CHEVROLET TRUCK (Ver también GMC) DURA SUSPENSION EAST MANUFACTURING CORP. FREIGHTLINER FRUEHAUF GMC TRUCK GREAT DANE TRAILER HENDRICKSON TRAILER SUSPENSION SYSTEMS HIGHWAY PRODUCT HUTCHENS SUSPENSION INGERSOLL AXLES KENWORTH MACK MC NEILUS TRUCK & MAN. MOHAWK ORION BUS INDUSTRIES PAGE SUSPENSION PETERBILT REYCO SUSPENSION RIDEWELL CORPORATION SAF HOLLAND STOUGHTON TRAILERS INC. THOMAS SCHOOL BUS TRAILMOBILE CANADA CORP. TUTHILL TECHNOLOGIES TWIN COACH VOLVO WABASH NATIONAL WATSON & CHALIN MFG. INC.	<b>No Req.</b>	<b>89449</b>	FREIGHTLINER FREIGHTLINER CUSTOM CHASSIS THOMAS SCHOOL BUS	<b>No Req.</b>
<b>89427</b>	INTERNATIONAL (NAVISTAR) KENWORTH MACK PACCAR PETERBILT VOLVO	<b>145099(1)</b>	<b>89437</b>	EAST MANUFACTURING CORP. HENDRICKSON TRUCK SUSPENSION SYSTEMS THOMAS SCHOOL BUS	<b>No Req.</b>	<b>89450</b>	MACK VOLVO	<b>No Req.</b>
<b>89428</b>	FREIGHTLINER INTERNATIONAL (NAVISTAR) KENWORTH MACK PETERBILT VOLVO	<b>145089-000(1)</b>	<b>89438</b>	FORD STERLING TRUCK	<b>145080(2)</b>	<b>89451</b>	KENWORTH PETERBILT	<b>No Req.</b>
<b>89429</b>	FREIGHTLINER KENWORTH MAECO PETERBILT VOLVO	<b>401754(4)</b>	<b>89439</b>	FORD STERLING TRUCK	<b>145080(2)</b>	<b>89453</b>	FREIGHTLINER HENDRICKSON TRUCK SUSPENSION SYSTEMS MC NEILUS TRUCK & MAN. STERLING TRUCK WESTERN STAR	<b>No Req.</b>
<b>89430</b>	AUTOCAR BLUEBIRD SCHOOL BUS CHEVROLET TRUCK (Ver también GMC) EAST MANUFACTURING CORP. FORD FREIGHTLINER FREIGHTLINER CUSTOM CHASSIS GMC TRUCK HENDRICKSON TRAILER SUSPENSION SYSTEMS HENDRICKSON TRUCK SUSPENSION SYSTEMS HINO INTERNATIONAL (NAVISTAR) MACK MAECO MERCEDES BENZ OSHKOSH MOTORS REYCO SUSPENSION RIDEWELL CORPORATION SAF HOLLAND TUTHILL TECHNOLOGIES VOLVO WABASH NATIONAL WATSON & CHALIN MFG. INC.	<b>No Req.</b>	<b>89440</b>	BLUEBIRD SCHOOL BUS CHEVROLET TRUCK (Ver también GMC) EAST MANUFACTURING CORP. FORD FRUEHAUF GMC TRUCK HENDRICKSON TRAILER SUSPENSION SYSTEMS HENDRICKSON TRUCK SUSPENSION SYSTEMS INTERNATIONAL (NAVISTAR) KENWORTH MAECO OSHKOSH MOTORS PACIFIC TRUCK & TRAILER PIERCE MANUFACTURING INC. REYCO SUSPENSION SAF HOLLAND STERLING TRUCK TUTHILL TECHNOLOGIES VOLVO WABASH NATIONAL	<b>No Req.</b>	<b>89454</b>	HENDRICKSON TRUCK SUSPENSION SYSTEMS MACK MC NEILUS TRUCK & MAN. VOLVO	<b>No Req.</b>
<b>89431</b>	BLUEBIRD SCHOOL BUS FREIGHTLINER FREIGHTLINER CUSTOM CHASSIS INTERNATIONAL (NAVISTAR) OSHKOSH MOTORS PIERCE MANUFACTURING INC.	<b>No Req.</b>	<b>89441</b>	FORD KENWORTH SAF HOLLAND	<b>145054(1)</b>	<b>89455</b>	KENWORTH PETERBILT	<b>141108(1)</b>
			<b>89442</b>	WESTERN STAR	<b>145126(2)</b>	<b>89456</b>	KENWORTH PETERBILT	<b>145089-200(1)</b>
			<b>89443</b>	FREIGHTLINER STERLING TRUCK THOMAS SCHOOL BUS	<b>No Req.</b>	<b>89457</b>	INTERNATIONAL (NAVISTAR)	<b>No Req.</b>
						<b>89458</b>	INTERNATIONAL (NAVISTAR)	<b>No Req.</b>
						<b>89459</b>	KENWORTH PETERBILT	<b>401754(2)</b>
						<b>89460</b>	KENWORTH PETERBILT	<b>No Req.</b>
						<b>89461</b>	GILLIG BROS.	<b>No Req.</b>



# Fleetline® GasSLX® Intercambio

Fleetline	GasSLX
83122	89406
83123	89405
83124	89407
83126	89430
83128	89436
83203	89436
83207	89407
83209	89414
83219	89408
83309	89446
83312	89409
83456	89447
85000	89436
85001	89410
85003	89411
85005	89430
85007	89412
85012	89413
85013	89414
85023	89415
85024	89416
85026	89417
85027	89418
85030	89440
85033	89427
85036	89405
85046	89434
85047	89435
85053	89442
85054	89438
85055	89439

Fleetline	GasSLX
85058	89431
85061	89450
85062	89408
85066	89448
85067	89451
85069	89455
85070	89459
85084	89460
85300	89419
85302	89420
85303	89422
85308	89422
85310	89423
85311	89424
85314	89425
85316	89426
85319	89428
85320	89429
85323	89436
85705	89447
85724	89443
85906	89407
85916	89430
85918	89449
85923	89458
85924	89457
85931	89458
85932	89453
85933	89454
85936	89456



**NOTA IMPORTANTE:** El intercambio entre series se debe hacer solamente de FLEETLINE a GASSLX. **NO AL REVÉS.**



Maneja el espíritu independiente™

## Lista de Intercambios contra Competidores y Equipo Original

### ABC BUS

# E.O.	Fleetline	GasSLX	# E.O.	Fleetline	GasSLX	# E.O.	Fleetline	GasSLX	# E.O.	Fleetline	GasSLX
050134513	85732		12J-5-10	85733		3166657	85700		624314570	695406	
10685703	695406		12L-5-114	85727		6243-13790	85708		680323	85700	
12B-5-1	85735		12L-5-88	85729		6243-14040	85708		90-2291	695406	

### ACF BRILL BUS

# E.O.	Fleetline	GasSLX	# E.O.	Fleetline	GasSLX	# E.O.	Fleetline	GasSLX	# E.O.	Fleetline	GasSLX
610513	85307		641521	85308	89422	659129	85303	89422	661733	83225	
631237	85308	89422	649648	85308	89422	661732	83215		995891	85307	

### ADVANCE MIXER

# E.O.	Fleetline	GasSLX	# E.O.	Fleetline	GasSLX	# E.O.	Fleetline	GasSLX	# E.O.	Fleetline	GasSLX
12111 ADV	646155		13883 ADV	85334		23458 ADV	83112				
13424 ADV	83207	89407	14626 ADV	83209		680087	85334				

### ALLCO TRAILER

# E.O.	Fleetline	GasSLX	# E.O.	Fleetline	GasSLX	# E.O.	Fleetline	GasSLX	# E.O.	Fleetline	GasSLX
727602	83122	89406									

### AM GENERAL

# E.O.	Fleetline	GasSLX	# E.O.	Fleetline	GasSLX	# E.O.	Fleetline	GasSLX	# E.O.	Fleetline	GasSLX
3166657	85700		5957136	85700		5979484	85302	89420			
4975501	85700		5969438	85700		5979574	85700				
5565748	85700		5978712	85700		5982537	85700				

### ARALMEX

Aralmex	Fleetline	GasSLX	Aralmex	Fleetline	GasSLX	Aralmex	Fleetline	GasSLX	Aralmex	Fleetline	GasSLX
2AMG037	G63375		3AMG007	G63357		3AMG023	G63421		3AMG031	G63360	
3AMG001	G63355		3AMG008	G63500		3AMG026	G63455		3AMG032	G63502	
3AMG004	G63306		3AMG009	G63406		3AMG027	G63426		3AMG033	G63614	
3AMG005	G63359		3AMG021	G63409		3AMG029	G63488		3AMG034	G63608	
3AMG006	G63377		3AMG022	G63454		3AMG030	G63818		3AMG035	G63607	

### ARVIN MERITOR

# E.O.	Fleetline	GasSLX	# E.O.	Fleetline	GasSLX	# E.O.	Fleetline	GasSLX	# E.O.	Fleetline	GasSLX
085009	85009		665769	85052		680322	85704		695172	85707	
085014	85014		665804	85939		680518	85700		695214	85722	
085321	85321		671092	85012	89413	680584	85938		695406	695406	
654907	85000	89436	671707	85052		680671	85708		7805-N-1002	85329	
665724	85000	89436	680102	85712		695159	85982		7805-S-1007	85329	

### AUTOCAR

# E.O.	Fleetline	GasSLX	# E.O.	Fleetline	GasSLX	# E.O.	Fleetline	GasSLX	# E.O.	Fleetline	GasSLX
03-1106460	85005	89430	28R010	83216		37301-3202	85026	89417	8071524	85024	89416
1011839	83216		35901-3201	85024	89416	660186	83216		849246	83216	
28CFG-910	83216		37301-3201	85027	89418	8026658	85046	89434			

### BATCO

Batco	Fleetline	GasSLX	Batco	Fleetline	GasSLX	Batco	Fleetline	GasSLX	Batco	Fleetline	GasSLX
1083203	83203	89436	1083225	83225		1085005	85005	89430	1085311	85311	89424
1083204	83204		1083310	83221		1085007	85007	89412	1087001	85734	
1083207	83207	89407	1083317	83317		1085300	85300	89419	1087004	85735	
1083209	83209	89414	1085003	85003	89411	1085305	85305		1087006	85736	

### BECK BUS

# E.O.	Fleetline	GasSLX	# E.O.	Fleetline	GasSLX	# E.O.	Fleetline	GasSLX	# E.O.	Fleetline	GasSLX
14QK-140	85304		14QK-2102	85304							

### BENSON TRUCK BODIES INC.

# E.O.	Fleetline	GasSLX	# E.O.	Fleetline	GasSLX	# E.O.	Fleetline	GasSLX	# E.O.	Fleetline	GasSLX
90044089	83124	89407	A-20002	85000	89436						

### BERING TRUCK CORP.

# E.O.	Fleetline	GasSLX	# E.O.	Fleetline	GasSLX	# E.O.	Fleetline	GasSLX	# E.O.	Fleetline	GasSLX
47902-24	83121										

### BILSTEIN

Bilstein	Fleetline	GasSLX	Bilstein	Fleetline	GasSLX	Bilstein	Fleetline	GasSLX	Bilstein	Fleetline	GasSLX
B46-1594	85013	89414	B46-1725	85029		B46-2151	85007	89412			

**Nota Importante:** Los intercambios deben utilizarse para cuestiones de almacenamiento únicamente. Cuando se identifiquen varios intercambios, consulte la sección de aplicaciones de este catálogo.

# Lista de Intercambios contra Competidores y Equipo Original

**BILSTEIN... cont**

## BLUEBIRD SCHOOL BUS

# E.O.	Fleetline	GasSLX	# E.O.	Fleetline	GasSLX	# E.O.	Fleetline	GasSLX	# E.O.	Fleetline	GasSLX
00085991	85006		1668730	85013	89414	481700131438	85919		70397	85006	
00119797	85959		1707405	85005		58913-007	85959		7805-M-1001	85919	
0014605	85036	89405	1722214	85030	89440	58913-007L	85959		7805-N-1002	85329	
0014985	83137		1722222	85013	89414	58913-008	85959		7805-S-1007	85329	
0015222	85919		1746163	85006		58913-009	85959		87001-01A	85734	
0020326	85976		1750793	85712		58913-010	85106		8C24-18045-DA	83177	
0040015	85919		1962422	85304		58913-011	85959		8C24-18080-DB	83178	
0055008	85959		1962430	83207	89407	59057-001	83137		8C2Z-18124-D	83177	
0055017	85959		2021459	85012	89413	59057-002	85036	89405	8C2Z-18125-D	83178	
0075916	85086		23106-01	85975		59483-000	85919		90-1813	85712	
0085990	85959		300-0614966	85307		60665-005	85919		90-1951-SP1	85734	
0088035	85090		300-0614974	85304		609180	85304		90-1968	85712	
0106303	85106		300-0823047	85736		60998-001	85006		90-1968-SP1	85712	
0110808	83124	89407	300-0823054	85304		60998-002	85919		90-2610 SP1	87017	
0523047	85736		300-09612284	85734		60998-003	85006		90044448	85051	
0823054	85304		300-1316546	85006		614958	85307		90044915	83127	
1004167	85712		300-1317767	85029		614966	85307		90045050	85914	
1217934	85304		303-1350628	85712		614974	85304		90045083	85910	
1260008	87017		305-0961284	85734		65992-003	85959		A-4890	85712	
1316546	85006		471700000428	85006		65992-004	85106		AMS65109	85058	89431
1317767	85029		471700000456	85959		671933	85919		AMS65110	85005	89430
1526417	85052		471700000464	85090		680102	85712		AMS65119	85029	
1658525	85971		471700002919	85106		680155	85712		ASH-1136	83178	
1658533	85010		471700131545	85006		680667		89447	ASH-1154	83177	
1667831	85029		4759272		89447	680783	85304		AT-163G	83177	
1668722	85030	89440	4760958	85086		70317		89402	AT-164G	83178	

## BOGE

Boge	Fleetline	GasSLX	Boge	Fleetline	GasSLX	Boge	Fleetline	GasSLX	Boge	Fleetline	GasSLX
40-A85-0	85708										

## BROCKWAY SCHOOL BUS

# E.O.	Fleetline	GasSLX	# E.O.	Fleetline	GasSLX	# E.O.	Fleetline	GasSLX	# E.O.	Fleetline	GasSLX
14QK-281P10	85305		152398	85304		515231	85303	89422			
14QK-282P1	83216		152412	83215		530873	83207	89407			
14QK-282P3	83216		508657	85307		532397	85307				

## BUILT RITE

# E.O.	Fleetline	GasSLX	# E.O.	Fleetline	GasSLX	# E.O.	Fleetline	GasSLX	# E.O.	Fleetline	GasSLX
318-06-100	85006										

## BUS & TRUCK CO.

# E.O.	Fleetline	GasSLX	# E.O.	Fleetline	GasSLX	# E.O.	Fleetline	GasSLX	# E.O.	Fleetline	GasSLX
0100-905	85307		680091	85303	89422	70039	85303	89422	70041	85305	

## CARPENTER BUS

# E.O.	Fleetline	GasSLX	# E.O.	Fleetline	GasSLX	# E.O.	Fleetline	GasSLX	# E.O.	Fleetline	GasSLX
0272-SS5	85712		63-0001	85713							

## CASCADE TRAILER

# E.O.	Fleetline	GasSLX	# E.O.	Fleetline	GasSLX	# E.O.	Fleetline	GasSLX	# E.O.	Fleetline	GasSLX
120-1	83125										

## CHALLENGE

# E.O.	Fleetline	GasSLX	# E.O.	Fleetline	GasSLX	# E.O.	Fleetline	GasSLX	# E.O.	Fleetline	GasSLX
632147	632147		632155	646177							

## CHALMERS SUSPENSION

# E.O.	Fleetline	GasSLX	# E.O.	Fleetline	GasSLX	# E.O.	Fleetline	GasSLX	# E.O.	Fleetline	GasSLX
21335	G63355		665174	85060		800670	85301		800781	85314	89425

**Nota Importante:** Los intercambios deben utilizarse para cuestiones de almacenamiento únicamente. Cuando se identifiquen varios intercambios, consulte la sección de aplicaciones de este catálogo.



## Lista de Intercambios contra Competidores y Equipo Original

### CHAMPION TRANSIT

# E.O.	Fleetline	GasSLX	# E.O.	Fleetline	GasSLX	# E.O.	Fleetline	GasSLX	# E.O.	Fleetline	GasSLX
22064230	83136		22064231	85324							

### CHANCE BUS

# E.O.	Fleetline	GasSLX	# E.O.	Fleetline	GasSLX	# E.O.	Fleetline	GasSLX	# E.O.	Fleetline	GasSLX
270-6708	85014		665017	85014		6893	83203	89436	AS789B	85014	
59039	83207	89407	6892	83207	89407	728600	83203	89436			

### CHANCE COACH

# E.O.	Fleetline	GasSLX	# E.O.	Fleetline	GasSLX	# E.O.	Fleetline	GasSLX	# E.O.	Fleetline	GasSLX
2021459	85012	89413									

### CHEVROLET TRUCK (Ver también GMC)

# E.O.	Fleetline	GasSLX	# E.O.	Fleetline	GasSLX	# E.O.	Fleetline	GasSLX	# E.O.	Fleetline	GasSLX
1-51630-168-1	G63610		22024673	85710		4940606	83126	89430	5357959	85300	89419
1-51630-217-0	83114		22045526	85702		4940614	83216		5361994	85734	
1-51630-217-1	83114		22046481	85702		4940627	83203	89436	5374779	85308	89422
1-51630-219-1	83114		22046483	85304		4940640	83216		5374999	85307	
12474915	83122	89406	22046485	85710		4940650	83207	89407	5385939	85307	
12474917	83121		22046489	85303	89422	4940654	83216		5392387	85303	89422
15123676	83136		22046499	85710		4940660	83207	89407	5394448	85305	
15174898	83136		2204683	85304		4940662	83126	89430	5394467	85305	
15174901	85342		22052014	85702		4963844	85307		5394468	85735	
15174902	85071		22052336	85304		4963853	83216		5455798	85307	
15174903	85342		22052424	85710		4963854	83216		5513489	83216	
15185643	83153		22064230	83136		4964853	83217		5513716	85304	
15185644	83155		22064231	85324		4974401	85700		5516459	85305	
15588554	83136		22064232	85071		4975429	85300	89419	5522781	85735	
15642943	83136		22064233	83136		4975467	83207	89407	5522794	85308	89422
15740554	83121		22064432	85050		4975479	83400		5522818	85305	
15887728	83136		22064489	85336		4975480	83400		5527001	85300	89419
15963161	83122	89406	22064804	83136		4975494	83207	89407	5527271	85700	
19152843	83136		22064805	83136		4975497	83126	89430	5527272	85700	
21998392	85336		22064806	83136		4975510	83221		5527606	85305	
22002293	83126	89430	22064807	83136		4975515	85701		5531027	85301	
22002294	83304		22065218	G63347		4975516	85702		5531435	85307	
22002295	83303		22065251	85030	89440	4975518	85704		5531436	85307	
22007700	83207	89407	22099889	85336		4975538	85700		5531437	85307	
22007701	83126	89430	22165187	83136		4975549	83216		5532026	85304	
22007702	83304		22165188	83136		4975550	85702		5532425	83207	89407
22007703	83303		22165189	83136		4984526	83216		5532433	83207	89407
22007750	83207	89407	22166442	83136		507-22	85342		5532675	85307	
22007751	83303		3171068	83216		507-23	85342		5534430	85303	89422
22007752	83304		3171069	85304		507-24	85336		5534439	85304	
22007753	83303		3171462	83126	89430	507-3	85307		5534447	85303	89422
22012065	85304		3171696	85307		508-86	83136		5544060	85302	89420
22012067	85700		3172948	85303	89422	508-88	83153		5544112	83216	
22012079	85701		3175509	85735		508-89	83155		5544581	85302	89420
22012082	85702		3178157	85700		5171068	83216		5544716	85304	
22012083	85711		3178233	85734		5316784	85700		5544717	85304	
22012090	85308	89422	3178507	85700		5316791	83219		5544812	83308	
22012091	85303	89422	3178995	85700		5316792	85305		5544818	85735	
22012095	83126	89430	3188626	85300	89419	5316793	85305		5549899	83207	89407
22012096	83221		3188729	85303	89422	5321920	85307		5549924	85700	
22012114	85700		3192657	83216		5321929	85307		5549925	85304	
22012131	85711		3192890	83126	89430	5348631	83203	89436	5552111	85304	
22012166	83126	89430	3192892	83221		5352858	85305		5552112	85307	
22012169	83221		4939852	85308	89422	5353054	85303	89422			
22017530	83303		4939967	85308	89422	5355798	85307				
22017531	83303		4940600	83209	89414	5357955	85300	89419			
22024062	85701		4940601	83216		5357956	85734				

**Nota Importante:** Los intercambios deben utilizarse para cuestiones de almacenamiento únicamente. Cuando se identifiquen varios intercambios, consulte la sección de aplicaciones de este catálogo.

# Lista de Intercambios contra Competidores y Equipo Original

## CHEVROLET TRUCK (Ver también GMC)... cont

# E.O.	Fleetline	GasSLX	# E.O.	Fleetline	GasSLX	# E.O.	Fleetline	GasSLX	# E.O.	Fleetline	GasSLX
5552114	83216		5552452	85303	89422	684280	83209	89414	9-51630-666-0	85012	89413
5552205	83217		5552453	85301		8-94057-593-0	83114		9-51630-666-2	85012	89413
5552206	83214		5552456	85307		8-94454-986-0	G63616		94033786	83114	
5552207	83217		5552527	85735		8-94454-987-0	G63616		94051090	83114	
5552208	83217		5552552	85303	89422	8-97201-960-0	G63616		94057593	83114	
5552209	83215		5554184	85302	89420	88963409	85336		94454987	G63616	
5552210	85308	89422	5554589	85307		88982682	83136		97-2210-00153	85701	
5552244	85308	89422	5554596	85303	89422	88982684	83136		97-2210-00164	85708	
5552285	83214		5554814	85302	89420	88982685	85342		97-2210-00170	85733	
5552286	83217		5554959	83401		88982686	85071		97083027	G63616	
5552287	83217		5554995	85305		88982687	85342		97083029	G63616	
5552288	83217		5559363	83203	89436	88982688	85336		97201960	G63616	
5552451	85308	89422	5585939	85307		9-51630-647-1	G63616		L-12706	83155	

## CHEVROLET TRUCK AMORTIGUADORES DE CABINA

# E.O.	Fleetline	GasSLX	# E.O.	Fleetline	GasSLX	# E.O.	Fleetline	GasSLX	# E.O.	Fleetline	GasSLX
1202-0012	83023		1202-0022	83046		1202-0032	83016		1202-0054	83021	

## CHRYSLER

# E.O.	Fleetline	GasSLX	# E.O.	Fleetline	GasSLX	# E.O.	Fleetline	GasSLX	# E.O.	Fleetline	GasSLX
2961043	G63183		3633744	G63183		3638112	G63183				

## CLARK EQUIPMENT

# E.O.	Fleetline	GasSLX	# E.O.	Fleetline	GasSLX	# E.O.	Fleetline	GasSLX	# E.O.	Fleetline	GasSLX
355778	85315		5532675	85307		680042	85301				

## COACHMEN RV

# E.O.	Fleetline	GasSLX	# E.O.	Fleetline	GasSLX	# E.O.	Fleetline	GasSLX	# E.O.	Fleetline	GasSLX
141700131809	85029		16-16736-000	85029		16-16873-000	85029		16-18103-000	85900	
141700131810	83160		16-16737-000	83160		16-16874-000	83160		481700000493	85900	

## COFAP

Cofap	Fleetline	GasSLX	Cofap	Fleetline	GasSLX	Cofap	Fleetline	GasSLX	Cofap	Fleetline	GasSLX
45011	85702		45094	85949		45238	85949		L-12476	85074	
45054	85301		45095	85948		45240	85981		L-12477	85073	
45056	85315		45096	85951		8482	85026	89417	L-12488	85073	
45058	85301		45117	85918	89449	ATG-046	G63457		L-12590	85074	
45058	85941		45137	85948		ATG-051	G63426		L-12601	85077	
45086	85949		45139C-Y	85901		ATG-081	G63502		L-12602	85076	
45087	85943		45160	85946		ATG-084	G63608		L-12687	83030	
45089	85940		45174	85947		ATG-085	G63607		L-12703	85071	
45089	85949		45189	85950		L-12039	85065		L-12706	83155	
45090	85942		45200	85941		L-12040	85073		L-12713	83136	
45091	85944		45235	85946		L-12151	85075		L-13092	85073	

## CONDUMEX

Condumex	Fleetline	GasSLX	Condumex	Fleetline	GasSLX	Condumex	Fleetline	GasSLX	Condumex	Fleetline	GasSLX
43066	83309	89446	53062	83009		58055	85003	89411	69673	83209	89414
43136	83017		53063	83025		58056	83137		69680	83200	
43137	83009		53065	83136		58057	83456	89447	69685	83136	
43138	83004		53066	83124	89407	58058	85031		69687	83100	
43139	83021		53078	85940		58059	85005		69688	85302	89420
43145	83021		53079	85074		58061	83122		69705	83122	89406
53010	83136		53080	83015		58061	85916		69711	83207	89407
53018	83317		58012	85314	89425	58062	85096		69712	85013	89414
53019	83456		58034	85013	89414	58065	85949		69713	85046	89434
53038	85103		58038	85001	89410	58067	85942		69714	83215	
53039	85006		58040	85026	89417	69500	83122	89406	69715	85000	89436
53040	85006		58041	83456		69515	83124	89407	69716	85024	89416
53041	85310	89423	58047	85381		69669	83123	89405			
53042	83309		58048	83137		69670	85051				
53043	83215		58049	85323	89436	69671	85006				
53059	85051		58050	85061	89450	69672	85043				

**Nota Importante:** Los intercambios deben utilizarse para cuestiones de almacenamiento únicamente. Cuando se identifiquen varios intercambios, consulte la sección de aplicaciones de este catálogo.

## Lista de Intercambios contra Competidores y Equipo Original

### CONDUMEX... cont

Condumex	Fleetline	GasSLX	Condumex	Fleetline	GasSLX	Condumex	Fleetline	GasSLX	Condumex	Fleetline	GasSLX
69717	85310	89423	69746	83137		78007	85307		78030	85316	89426
69720	85736		69747	85003		78009	85303	89422	78034	85920	
69725	85918	89449	69748	85001	89410	78013	85323	89436	78039	85311	
69726	85319		69750	85314	89425	78015	85724	89443	USA53085	83512	
69728	85055	89439	69752	85316	89426	78016	85001	89410	USA53086	83511	
69729	85314	89425	69753	85031		78020	85712		USA53087	83506	
69732	85300	89419	78001	85314	89425	78023	85705		USA53088	83513	
69741	85906		78002	85702		78025	85009		USA53091	83508	
69743	85061	89450	78003	85308	89422	78026	85706		USA53092	83509	
69745	85058	89431	78005	85310	89423	78027	85314	89425			

### CONTINENTAL TRAILWAYS-EAGLE INT'L

# E.O.	Fleetline	GasSLX	# E.O.	Fleetline	GasSLX	# E.O.	Fleetline	GasSLX	# E.O.	Fleetline	GasSLX
01-0100-020	85307		5394467	85305		6-05-5	85307		70039	85303	89422
01-0100-905	85303	89422	5532026	85304		680091	85303	89422	70041	85305	

### COUNTRY COACH

# E.O.	Fleetline	GasSLX	# E.O.	Fleetline	GasSLX	# E.O.	Fleetline	GasSLX	# E.O.	Fleetline	GasSLX
89406		89406	89414		89414						

### CRANE CARRIER

# E.O.	Fleetline	GasSLX	# E.O.	Fleetline	GasSLX	# E.O.	Fleetline	GasSLX	# E.O.	Fleetline	GasSLX
277A-1	85307		277A-13	85302	89420	277A-8	85303	89422	680088	85713	
277A-12	85304		277A-14	85304		277A-9	85307		680091	85303	89422

### CROWN COACH

# E.O.	Fleetline	GasSLX	# E.O.	Fleetline	GasSLX	# E.O.	Fleetline	GasSLX	# E.O.	Fleetline	GasSLX
3188729	85303	89422	5532026	85304		5532036	85734				

### CUNHA PRODUCTS OHD

# E.O.	Fleetline	GasSLX	# E.O.	Fleetline	GasSLX	# E.O.	Fleetline	GasSLX	# E.O.	Fleetline	GasSLX
CP-5222	85315										

### DANA

# E.O.	Fleetline	GasSLX	# E.O.	Fleetline	GasSLX	# E.O.	Fleetline	GasSLX	# E.O.	Fleetline	GasSLX
SR1VJ100	85078										

### DELCO

Delco	Fleetline	GasSLX	Delco	Fleetline	GasSLX	Delco	Fleetline	GasSLX	Delco	Fleetline	GasSLX
501-13	83318		507-8	85301		508-35	G63306		508-70	G63416	
501-74	83304		507-9	85700		508-35	G63371		508-71	83314	
501-75	83303		508-13	85012	89413	508-39	G63347		508-71	G63398	
507-1	85304		508-14	83216		508-42	G63353		508-72	G63386	
507-10	85711		508-14	85012	89413	508-42	G63389		508-74	G63511	
507-11	85308	89422	508-15	83216		508-47	G63350		508-78	83400	
507-12	85701		508-16	83308	89435	508-47	G63377		508-79	G63424	
507-13	85704		508-17	83312	89409	508-48	G63409		508-80	G63425	
507-15	85703		508-18	83309	89446	508-48	G63427		508-82	G63410	
507-16	85702		508-19	83314		508-5	G63359		508-86	83136	
507-17	85304		508-20	83207	89407	508-5	G63360		508-87	85071	
507-18	85305		508-21	83214		508-50	G63299		508-88	83153	
507-19	85700		508-22	83217		508-50	G63907		508-89	83155	
507-2	85302	89420	508-23	83217		508-52	G63405		508-9	85000	89436
507-22	85342		508-23	83225		508-52	G63419		508-90	83136	
507-23	85342		508-24	83215		508-52	G63492		550-13	85005	89430
507-24	85336		508-26	83203	89436	508-56	G63605		550-73	83303	
507-3	85307		508-26	85030	89440	508-57	83123	89405	550-73	85005	89430
507-4	85303	89422	508-28	83207	89407	508-59	G63183		550-74	83304	
507-5	85308	89422	508-29	85030	89440	508-68	83209	89414	550-75	83303	
507-6	85314	89425	508-3	83400		508-68	85006		550-77	83221	
507-7	85301		508-30	85005	89430	508-70	G63396				

**Nota Importante:** Los intercambios deben utilizarse para cuestiones de almacenamiento únicamente. Cuando se identifiquen varios intercambios, consulte la sección de aplicaciones de este catálogo.

# Lista de Intercambios contra Competidores y Equipo Original

## DEXTER AXLE

# E.O.	Fleetline	GasSLX	# E.O.	Fleetline	GasSLX	# E.O.	Fleetline	GasSLX	# E.O.	Fleetline	GasSLX
18165-01	85006										

## DIAMOND T

# E.O.	Fleetline	GasSLX	# E.O.	Fleetline	GasSLX	# E.O.	Fleetline	GasSLX	# E.O.	Fleetline	GasSLX
5549925	85304										

## DIAMOND-REO

# E.O.	Fleetline	GasSLX	# E.O.	Fleetline	GasSLX	# E.O.	Fleetline	GasSLX	# E.O.	Fleetline	GasSLX
220-55-1	83214		220-55-6	83214		220-55-8	83217				
220-55-2	85304		220-55-7	85304		220-S5-10	85712				

## DINA

# E.O.	Fleetline	GasSLX	# E.O.	Fleetline	GasSLX	# E.O.	Fleetline	GasSLX	# E.O.	Fleetline	GasSLX
1520030010	83317		39380353-6	85716		39390340-4	85716		55002	85983	
152E030030	85014		39390339-6	85307		510002	85983				

## DODGE TRUCK

# E.O.	Fleetline	GasSLX	# E.O.	Fleetline	GasSLX	# E.O.	Fleetline	GasSLX	# E.O.	Fleetline	GasSLX
2516009	G63183		2961043	G63183		3633744	G63183		3638631	G63605	
2960707	G63183		3633643	G63183		3638112	G63183		4036892	G63605	

## DUPLEX TRUCK

# E.O.	Fleetline	GasSLX	# E.O.	Fleetline	GasSLX	# E.O.	Fleetline	GasSLX	# E.O.	Fleetline	GasSLX
59024	83204		7604-3371	83204							

## DURA SUSPENSION

# E.O.	Fleetline	GasSLX	# E.O.	Fleetline	GasSLX	# E.O.	Fleetline	GasSLX	# E.O.	Fleetline	GasSLX
1080099	83203	89436	59024	83204		665133	83203	89436	7604-3371	83204	
12866	83207	89407	59030	83203	89436	665267	85029		A-2212	85029	

## EAGLE MOTOR COACH

# E.O.	Fleetline	GasSLX	# E.O.	Fleetline	GasSLX	# E.O.	Fleetline	GasSLX	# E.O.	Fleetline	GasSLX
01-0100-020	85307		101364	85305		5394467	85305		690060	85713	
01-0100-905	85303	89422	12B-5-1	85735		5532026	85304		70039	85303	89422
014-0100-905	85308	89422	12J-5-10	85733		6-05-5	85307		70041	85305	
0140100-905	85308	89422	154-0100-514	85314	89425	680091	85303	89422			

## EAST MANUFACTURING CORP.

# E.O.	Fleetline	GasSLX	# E.O.	Fleetline	GasSLX	# E.O.	Fleetline	GasSLX	# E.O.	Fleetline	GasSLX
517-05001-18	87015		517-05010-07	83214		517-05805-20	85000	89436	517-05916-14	83124	89407
517-05001-23	85005	89430	517-05022-07	83217		517-05806-20	85029		A-20002	85000	89436
517-05006-20	85030	89440	517-05110-20	85000	89436	517-05808-20	85738		A-20126	85323	89436
517-05009-14	83125		517-05511-14	83128		517-05809-20		89437			

## ELDORADO NATIONAL

# E.O.	Fleetline	GasSLX	# E.O.	Fleetline	GasSLX	# E.O.	Fleetline	GasSLX	# E.O.	Fleetline	GasSLX
13208701	85746		13208801	85745							

## EUCLID

Euclid	Fleetline	GasSLX	Euclid	Fleetline	GasSLX	Euclid	Fleetline	GasSLX	Euclid	Fleetline	GasSLX
E14009	85933	89454	E83213	83213		E83309	83309	89446	E85011	85011	
E14021	85955		E83214	83214		E83310	83221		E85012	85012	89413
E14022	85955		E83215	83215		E83311	83311		E85013	85013	89414
E14037	85967		E83216	83216		E83312	83312	89409	E85014	85014	
E14042	85965		E83217	83217		E83314	83314		E85024	85024	89416
E14043	85966		E83218	83122	89406	E83318	83318		E85026	85026	89417
E14045	83143		E83219	83219		E83353	83353		E85029	85029	
E14046	83142		E83221	83221		E83400	83400		E85030	85030	89440
E83200	83200		E83223	83223		E83401	83401		E85300	85300	89419
E83201	83201		E83225	83225		E85000	85000	89436	E85302	85302	89420
E83202	83202		E83242	83242		E85001	85001	89410	E85303	85303	89422
E83203	83203	89436	E83300	83300		E85003	85003	89411	E85304	85304	
E83204	83204		E83301	83301		E85005	85005	89430	E85305	85305	
E83205	83209	89414	E83302	83302		E85006	85006				
E83206	83206		E83303	83303		E85007	85007	89412			
E83207	83207	89407	E83304	83304		E85008	85008				
E83209	83209	89414	E83308	83308	89435	E85010	85010				

**Nota Importante:** Los intercambios deben utilizarse para cuestiones de almacenamiento únicamente. Cuando se identifiquen varios intercambios, consulte la sección de aplicaciones de este catálogo.

## Lista de Intercambios contra Competidores y Equipo Original

### EUCLID... cont

Euclid	Fleetline	GasSLX	Euclid	Fleetline	GasSLX	Euclid	Fleetline	GasSLX	Euclid	Fleetline	GasSLX
E85307	85307		E85318	85318		E85709	85709		E87004	85735	
E85308	85308	89422	E85700	85700		E85711	85711		E87006	85736	
E85310	85310	89423	E85702	85702		E85712	85712		E87011	85707	
E85311	85311	89424	E85703	85703		E85713	85713		E87012	85705	
E85312	85312		E85704	85704		E87000	85711		E87013	85706	
E85313	85313		E85705	85705		E87001	85734				
E85314	85314	89425	E85706	85706		E87003	85700				

### FLEETRITR

Fleetririte	Fleetline	GasSLX	Fleetririte	Fleetline	GasSLX	Fleetririte	Fleetline	GasSLX	Fleetririte	Fleetline	GasSLX
AMS600101	85003	89411	AMS600163	83101		AMS650410	85300	89419	AMS650464	85716	
AMS600102	85005	89430	AMS600164	83613		AMS650411	85036	89405	AMS650465	85914	
AMS600103	85014		AMS600165	83636		AMS650412	83122	89406	AMS650466	85047	89435
AMS600104	85000	89436	AMS600166	85052		AMS650413	65413		AMS650468	85069	89455
AMS600105	83304		AMS600167	83128		AMS650414	65414		AMS650471	85302	89420
AMS600106	83312	89409	AMS600168	83635		AMS650415	85046	89434	AMS650472	85330	
AMS600107	83309	89446	AMS600169	85051		AMS650416	85323	89436	AMS650473	85329	
AMS600108	83209	89414	AMS600172	85005	89430	AMS650417	85322		AMS650474	85712	
AMS600109	83217		AMS600173	85043		AMS650418	85906	89407	AMS650475	85065	
AMS600110	83303		AMS600174	83125		AMS650419	85000	89436	AMS650478	85030	89440
AMS600111	83301		AMS600175	83120		AMS650420	85013	89414	AMS650479	83122	89406
AMS600112	83456	89447	AMS600202	83009		AMS650421	85916		AMS650480	83109	
AMS600113	83215		AMS650101	85062	89408	AMS650422	85912		AMS650480	83111	
AMS600114	83125		AMS650102	85001	89410	AMS650423	85907		AMS650481	83123	89405
AMS600116	83216		AMS650103	85320	89429	AMS650424	85905		AMS650482	85006	
AMS600117	83308	89435	AMS650104	65104		AMS650425	89441		AMS650486	85066	89448
AMS600118	83219		AMS650105	85026	89417	AMS650426	85054	89438	AMS65107	85316	89426
AMS600119	83314		AMS650106	65106		AMS650427	85903		AMS65109	85058	89431
AMS600120	G63605		AMS650107	85316	89426	AMS650428	85321		AMS65144	85957	
AMS600123	G63183		AMS650108	85030	89432	AMS650429	85030	89440	AMS65146	85925	
AMS600125	83123	89405	AMS650109	85058	89431	AMS650430	85712		AMS65158	85954	
AMS600126	83400		AMS650110	85005	89430	AMS650431	85909		AMS660102	85005	89430
AMS600127	83161		AMS650111	85006		AMS650432	85910		AMS660103	85014	
AMS600128	83401		AMS650112	89402		AMS650433	85910		AMS660104	85000	89436
AMS600129	83317		AMS650113	85012	89413	AMS650434	85012	89413	AMS660105	83304	
AMS600130	83204		AMS650114	85006		AMS650435	85901		AMS660106	83312	89409
AMS600131	83318		AMS650115	85027	89418	AMS650436	85900		AMS660107	83309	89446
AMS600132	83215		AMS650116	85303	89422	AMS650439	85718		AMS660108	83209	89414
AMS600133	83362		AMS650118	83215		AMS650440	85711		AMS660109	83217	
AMS600134	83221		AMS650119	85029		AMS650441	85704		AMS660110	83303	
AMS600136	83353		AMS650120	85010		AMS650442	85700		AMS660111	83301	
AMS600138	83100		AMS650121	89432		AMS650443	85706		AMS660112	83456	89447
AMS600139	83353		AMS650122	85063		AMS650444	85311	89424	AMS660113	83215	
AMS600142	83209	89414	AMS650123	85054	89438	AMS650445	85731		AMS660114	85006	
AMS600145	85040		AMS650124	85053	89442	AMS650446	85730		AMS660116	83216	
AMS600146	83105		AMS650128	85031		AMS650447	85703		AMS660117	83308	89435
AMS600147	83216		AMS650129	85701		AMS650448	85700		AMS660118	85012	89413
AMS600148	85026	89417	AMS650130	85061	89450	AMS650449	85702		AMS660119	83314	
AMS600149	83217		AMS650139	85918	89449	AMS650451	85029		AMS660120	G63605	
AMS600150	85009		AMS650400	85033	89427	AMS650452	85733		AMS660123	G63183	
AMS600151	85024	89416	AMS650401	85013	89414	AMS650453	85904		AMS660125	83123	89405
AMS600152	83242		AMS650402	85311	89424	AMS650454	85713		AMS660126	83400	
AMS600153	85003	89411	AMS650404	85310	89423	AMS650455	85716		AMS660127	83161	
AMS600154	83104		AMS650405	85023	89415	AMS650456	85376		AMS660128	83401	
AMS600155	83103		AMS650406	85024	89416	AMS650458	85908				
AMS600156	83103		AMS650407	85736		AMS650459	85043				
AMS600157	83221		AMS650408	85319	89428	AMS650462	85913				
AMS600162	83103		AMS650409	85003	89411	AMS650463	85040				

**Nota Importante:** Los intercambios deben utilizarse para cuestiones de almacenamiento únicamente. Cuando se identifiquen varios intercambios, consulte la sección de aplicaciones de este catálogo.

## Lista de Intercambios contra Competidores y Equipo Original

### FLEETRITE... cont

Fleetríte	Fleetline	GasSLX	Fleetríte	Fleetline	GasSLX	Fleetríte	Fleetline	GasSLX	Fleetríte	Fleetline	GasSLX
AMS660129	83317		AMS660177	83019		AMS660225	83200		AMS700405	85300	89419
AMS660130	83204		AMS660179	83162		AMS660232	83114		AMS700406	85711	
AMS660131	83318		AMS660182	83004		AMS660233	83023		AMS700407	85712	
AMS660132	83215		AMS660183	85012	89413	AMS660234	83013		AMS700408	85704	
AMS660133	83362		AMS660187	85071		AMS660236	83025		AMS700409	85701	
AMS660134	83221		AMS660188	85045		AMS660237	83005		AMS700410	85314	89425
AMS660136	83353		AMS660189	83136		AMS660238	83101		AMS700411	85703	
AMS660138	83100		AMS660190	83107		AMS660244	83125		AMS700413	85705	89447
AMS660142	83209	89414	AMS660191	83216		AMS660247	83116		AMS700414	85723	
AMS660145	85040		AMS660192	85001	89410	AMS660247	83118		AMS700415	85318	
AMS660146	83105		AMS660193	83001		AMS660248	83117		AMS700416	85709	
AMS660147	83216		AMS660194	83207	89407	AMS660502	646155		AMS700418	85003	89411
AMS660148	85026	89417	AMS660195	83130		AMS660504	632147		AMS700419	85708	
AMS660149	85042		AMS660196	G63610		AMS700101	85308	89422	AMS700420	85733	
AMS660150	G63616		AMS660197	G63866		AMS700102	85303	89422	AMS700421	85712	
AMS660153	85003	89411	AMS660198	83007		AMS700103	85302	89420	AMS700422	85308	89422
AMS660154	83104		AMS660200	83008		AMS700104	85304		AMS700423	85724	89443
AMS660155	83103		AMS660201	83308	89435	AMS700105	85314	89425	AMS700424	85333	
AMS660157	85030	89440	AMS660202	83009		AMS700106	85301		AMS74421	85708	
AMS660160	83114		AMS660203	83112		AMS700107	85307		AMS85722	83400	
AMS660161	G63610		AMS660204	83010		AMS700108	85315		AMS85736	G63394	
AMS660162	83103		AMS660205	83003		AMS700111	85320	89429	AMS85768	83209	89414
AMS660164	83613		AMS660208	G63616		AMS700112	85722		AMS85802	83216	
AMS660165	83636		AMS660209	83014		AMS700113	85736		AMS85803	G63306	
AMS660166	85052		AMS660211	83110		AMS700114	85701		AMS85821	G63406	
AMS660167	83128		AMS660212	83015		AMS700115	85712		AMS85853	G63183	
AMS660168	83635		AMS660213	85009		AMS700116	83136		AMS85895	83207	89407
AMS660169	85051		AMS660214	83002		AMS700117	85324		AMS85900	G63386	
AMS660170	83016		AMS660215	85059		AMS700119	85336		AMS85901	G63387	
AMS660171	83017		AMS660216	83123	89405	AMS700120	85332		AMS85904	G63299	
AMS660172	83126	89430	AMS660218	83137		AMS700121	83136		AMS85905	G63405	
AMS660173	85043		AMS660219	83215		AMS700401	85700		AMS85909	G63398	
AMS660174	83125		AMS660220	83109		AMS700402	85310	89423	AMS85932	G63398	
AMS660175	83120		AMS660223	85055	89439	AMS700403	85702		AMS85960	G63366	
AMS660176	83018		AMS660224	83111		AMS700404	85311	89424			

### FLEETWOOD RV

# E.O.	Fleetline	GasSLX	# E.O.	Fleetline	GasSLX	# E.O.	Fleetline	GasSLX	# E.O.	Fleetline	GasSLX
141700131809	85029		16-16736-000	85029		16-16873-000	85029		16-18103-000	85900	
141700131810	83160		16-16737-000	83160		16-16874-000	83160		481700000493	85900	

### FLUIDRIVE

# E.O.	Fleetline	GasSLX	# E.O.	Fleetline	GasSLX	# E.O.	Fleetline	GasSLX	# E.O.	Fleetline	GasSLX
2697	85712										

### FLXIBLE BUS

# E.O.	Fleetline	GasSLX	# E.O.	Fleetline	GasSLX	# E.O.	Fleetline	GasSLX	# E.O.	Fleetline	GasSLX
015813	85708		3166657	85700		6-05-6	85736		6-367-4	83217	
06-0367-00151	85700		3192333	85700		6-05-7	85736		6-367-6	85711	
06-0367-00156	85702		48-1-239	85736		6-05-8	85736		6-367-7	85305	
06-0367-00157	85701		48-1-241	85712		6-05-9	85304		6-367-8	85700	
22012067	85700		4975518	85704		6-367-1	85711		6-367-9	85711	
22012114	85700		6-05-1	85736		6-367-11	85711		680029	85301	
22024061	85704		6-05-10	85734		6-367-12	85700		680155	85712	
22024062	85701		6-05-13	85304		6-367-14	85700		680320	85703	
22024506	85703		6-05-2	85736		6-367-16	85700		695125	85704	
22025066	85703		6-05-3	85736		6-367-17	85700		74412	85704	
22025067	85704		6-05-4	85736		6-367-2	85736		87-2519-00001	85703	
22025305	85704		6-05-5	85307		6-367-3	85304		87-2519-00002	85731	

**Nota Importante:** Los intercambios deben utilizarse para cuestiones de almacenamiento únicamente. Cuando se identifiquen varios intercambios, consulte la sección de aplicaciones de este catálogo.

## Lista de Intercambios contra Competidores y Equipo Original

### FLXIBLE BUS... cont

# E.O.	Fleetline	GasSLX	# E.O.	Fleetline	GasSLX	# E.O.	Fleetline	GasSLX	# E.O.	Fleetline	GasSLX
87-2519-00003	85703		97-2201-00007	85703		97-2210-00011	85704		97-9999-02516	85701	
87-2519-00004	85731		97-2201-00008	85731		97-2210-00153	85701		97-9999-02519	85707	
87-2520-00001	85704		97-2201-00009	85703		97-2210-00156	85702		97-9999-02592	85710	
87-2520-00002	85730		97-2201-00151	85700		97-2210-00157	85708		97-9999-02595	85313	
87-2520-00003	85704		97-2210-00001	85704		97-2210-00160	85705	89447	97-9999-02632	85711	
87-2520-00004	85730		97-2210-00002	85704		97-2210-00162	85701		97-9999-02633	85311	89424
97-2201-00001	85703		97-2210-00003	85704		97-2210-00164	85708		97-9999-02634	85733	
97-2201-00002	85703		97-2210-00004	85704		97-2210-00170	85733		97-9999-02635	85718	
97-2201-00003	85703		97-2210-00005	85704		97-9999-00732	85707		97-9999-02636	85716	
97-2201-00004	85703		97-2210-00006	85704		97-9999-00807	85307				
97-2201-00005	85703		97-2210-00009	85704		97-9999-02514	85700				
97-2201-00006	85703		97-2210-00010	85730		97-9999-02515	85702				

### FLYER INDUSTRIES

# E.O.	Fleetline	GasSLX	# E.O.	Fleetline	GasSLX	# E.O.	Fleetline	GasSLX	# E.O.	Fleetline	GasSLX
009863	85722		22012067	85700		3192333	85700		592-6568	85700	
015915	85711		22012114	85700		4975501	85700		5979574	85700	
15813	85708		3166657	85700		4975552	85711				

### FORD

# E.O.	Fleetline	GasSLX	# E.O.	Fleetline	GasSLX	# E.O.	Fleetline	GasSLX	# E.O.	Fleetline	GasSLX
0017LA-18080-G	83161		5U2Z-18V124-AU	G63772		ASH-1022	83209		B9TZ-18125-B	83161	
1C34-18045-AA	83209		5U2Z-18V124-BA	G63716		ASH-1023	83122		C0TT-18045-A	83219	
1C34-18045-JA	83209		5U2Z-18V124-CAA	G63809		ASH-1228	83209		C0TT-18045-D	83216	
3553628C1	85927		5U2Z-18V124-DB	G63455		ASH-1230	83122		C0TZ-18124-A	83216	
3553628C2	85927		5U2Z-18V124-LA	G63929		ASH-137	83122		C1TT-18045-C	83312	89409
3578858C1	85926		5U2Z-18V125-AE	G63808		ASH-23486	G63461		C1TT-18045-D	G63406	
3578858C2	85926		5U2Z-18V125-AF	G63810		ASH-24446	83215		C1TT-18045-E	83314	
3584116C1	83175		5U2Z-18V125-BDA	G63623		ASH-247	G63461		C1TT-18045-G	83216	
3584116C2	83175		5U2Z-18V125-BGA	G63778		ASH-294	83209		C1TT-18080-B	83217	
3584117C2	83135		5U2Z-18V125-BS	G63607		AT-610	G63461		C1TZ-18045-C	83312	89409
3584118C2	85928		5U2Z-18V125-BT	G63525		AT-611	G63461		C1TZ-18124-A	83217	
3U2Z-18124-BAA	G63809		5U2Z-18V125-BU	G63524		AT-621	83122		C1TZ-18124-B	83216	
3U2Z-18124-EA	G63772		5U2Z-18V125-F	G63676		AT-696	83140		C1TZ-18124-C	83312	89409
3U2Z-18124-FA	G63608		5U2Z-18V125-G	G63837		AT-766	83209		C1TZ-18124-D	83309	89446
3U2Z-18124-YAA	G63809		5U2Z-18V125-H	G63406		AT-811	83135		C1TZ-18124-E	83312	89409
3U2Z-18125-CA	G63607		680029	85301		AX-267A	83309	89446	C1TZ-18124-F	83312	89409
3U2Z-18125-DA	G63525		6C2Z-18124-B	G63929		AX-310	83215		C1TZ-18124-N	83314	
3U2Z-18125-EA	G63524		6ETZ-18124-AA	83145		B3Q-18124-A	83219		C1TZ-18124-P	83312	89409
3U2Z-18125-RA	G63623		6ETZ-18125-A	83146		B3Q-18125-A	83217		C1TZ-18125-B	83217	
47902-13	83122	89406	70127	85006	89401	B3TZ-18125-A	83217		C1VT-18080-B	83217	
47902-28	85013	89414	70128	85006	89401	B6TZ-18124-A	83219		C2TA-18045-A	83216	
47902-8	83122	89406	7C34-18045-HB	G63969		B6TZ-18125-B	83161		C2TA-18045-B	83308	
4C4Z-18124-HB	83135		7C34-18080-DCB	77968		B6TZ-18125-C	83161		C2TZ-18124-A	83308	
4C4Z-18124-P	83135		87HU-18045-AA	85301		B6TZ-18125-E	83161		C3TA-18045-A	83216	
4C4Z-18124-QA	83175		90044769	83207	89407	B7C-18125-A	83217		C3TZ-18124-A	83308	
4C4Z-18124-RA	85928		90044770	83207	89407	B7T-18124-C	83225		C4HZ-18124-A	83312	89409
4C4Z-18125-B	83317		90045068		89441	B7TZ-18124-B	83216		C4HZ-18124-B	83309	89446
4C4Z-18125-DA	85926		90045099	85906	89407	B7TZ-18124-C	83216		C4HZ-18124-C	83314	
4U2Z-18V124-AA	G63678		90045132	85909		B7TZ-18124-D	83219		C4HZ-18124-D	83312	89409
501906C92	83317		9U94-18045-AA	83209		B7TZ-18124-E	83217		C4HZ-18124-E	83309	89446
57241-2	83109		9U94-18080-AA	83122		B7TZ-18125-C	83217		C4HZ-18124-F	83308	
57365-111	85006	89401	9U9Z-18124-A	83209		B8Q-18125-A	85307		C4PF-18045-H	83216	
5C3Z-18124-JA	G63969		9U9Z-18125-A	83122		B8QZ-18124-A	83312	89409	C4TZ-18124-AA	83308	
5C3Z-18125-CF	77969		AA-494	83131		B8TZ-18124-A	83219		C4TZ-18124-AB	83308	
5C3Z-18125-DA	77968		AA-615	83135		B9TT-18045-C	83219		C4TZ-18124-B	83308	
5U2Z-18V124-AA	G63714		AA-616	83175		B9TT-18045-D	83219		C5TZ-18124-A	83308	
5U2Z-18V124-AHA	G63622		AA-617	85928		B9TT-18080-B	83161		C6PF-18077-A	G63306	

**Nota Importante:** Los intercambios deben utilizarse para cuestiones de almacenamiento únicamente. Cuando se identifiquen varios intercambios, consulte la sección de aplicaciones de este catálogo.

## Lista de Intercambios contra Competidores y Equipo Original

### FORD... cont

# E.O.	Fleetline	GasSLX	# E.O.	Fleetline	GasSLX	# E.O.	Fleetline	GasSLX	# E.O.	Fleetline	GasSLX
C6PF-18077-AC	83161		D2HT-18045-EA	83312	89409	D7HT-18124-KA	85301		F1HT-18045-CA	83308	
C6PF-18077-DD	83216		D2HT-18045-GA	83308		D7HT-18125-BA	83217		F1HT-18045-CB	83216	
C6PF-18077-DE	83219		D2HT-18080-HA	83225		D7HT-18125-CA	83217		F1HT-18045-CA	83312	89409
C6PF-18077-DL	83312	89409	D2HZ-18080-A	83209	89414	D7HT-18125-DA	83215		F1HT-18045-DB	83308	
C6PF-18077-DN	83314		D2HZ-18125-A	83209	89414	D7HT-18125-FA	83123	89405	F1HT-18045-EA		89402
C6PF-18077-F	83225		D2HZ-18125-B	83209	89414	D7HZ-18125-A	83215		F1HT-18045-EB		89402
C6TA-18045-U	85301		D2KF-18045-AA	83312	89409	D7KF-18045-EA	83312	89409	F1HT-18045-GA	85006	89401
C6TA-18045-V	85301		D2KF-18124-AA	83312	89409	D7TA-18124-GA	83314		F1HT-18045-GB		89403
C6TA-18045-Y	85301		D2TA-18045-AAA	83219		D7TZ-18125-C	83217		F1HT-18045-HB	85006	89401
C6TA-18045-Z	85301		D2TA-18045-ZA	83219		D8HZ-18124-A	85301		F1HT-18045-KB	85006	89401
C6TS-18080-A	83217		D2TF-18045-AA	83312	89409	D8HZ-18125-A	83209	89414	F1HT-18045-LB	85006	89401
C6TZ-18124-D	85301		D2TF-18045-FA	83312	89409	D8HZ-18125-B	83123	89405	F1HT-18045-NA	85040	
C6TZ-18124-E	85301		D2TF-18045-GA	83308		E0HT-18045-AA	83309	89446	F1HT-18045-RA		89402
C6TZ-18124-H	85301		D2TF-18080-HA	83225		E0HT-18045-AB	83309	89446	F1HT-18045-RA		89441
C6TZ-18124-J	85301		D2TF-18080-NA	83217		E0HT-18080-AA	83215		F1HT-18045-RB		89402
C7HZ-18124-A	83312	89409	D2TF-18124-F	83309	89446	E0HT-18124-A	83309	89446	F1HZ-18124-A	83309	89446
C7PF-18077-A	83225		D2TZ-18124-A	83308		E1TA-18045-AA	83309	89446	F1HZ-18124-AA	83309	89446
C7PF-18077-Z	83217		D2TZ-18124-E	83312	89409	E1TD-18045-AA	83309	89446	F1HZ-18124-B	83308	
C7TA-18045-R	83216		D2TZ-18124-F	83309	89446	E5HT-18045-AA	85301		F1HZ-18124-C		89402
C7TA-18045-Z	85301		D2TZ-18124-G	83314		E5HT-18045-DA	85301		F1HZ-18124-D	85006	89401
C8HA-18045-A	83312	89409	D2TZ-18124-H	83308		E5HT-18045-EA	85301		F1HZ-18124-E	85006	89401
C8PF-18045-CM	83216		D2TZ-18124-J	83312	89409	E5HT-18080-DA	85315		F1HZ-18124-F	85006	89401
C8PF-18045-S	83161		D3TA-18045-BA	83219		E5HT-18080-EA	85315		F1HZ-18124-G	85006	89401
C8PF-18045-T	83161		D3TZ-18124-B	83219		E6HT-18080-AA	83215		F1HZ-18124-H	85040	
C8TA-18045-AA	G63386		D3TZ-18125-C	83217		E6HZ-18124-A	85301		F1HZ-18124-J	83308	
C8TA-18080-Y	83161		D3TZ-18125-D	83217		E6HZ-18124-D	85301		F1HZ-18124-K		89402
C8TA-18080-Z	83161		D4HA-18080-A	83209	89414	E6HZ-18125-D	83215		F2HT-18045-BA	85376	
C8TZ-18125-D	83161		D4HA-18080-AA	83209	89414	E6HZ-18125-E	85315		F2HT-18045-CA	85376	
D0HA-18045-D	83309	89446	D4TF-18045-AA	83312	89409	E6HZ-18125-F	85315		F2HT-18045-DA	85006	89401
D0HA-18045-E	83312	89409	D4TZ-18124-J	83308		E7HZ-18124-A	85301		F2HT-18080-DA	85712	
D0HZ-18124-A	83309	89446	D5TZ-18124-B	83308		E7XZ-18124-A	G63386		F2HZ-18124-A	85376	
D0HZ-18124-B	83312	89409	D5TZ-18124-C	83312	89409	E7XZ-18124-B	G63500		F2HZ-18124-B	85301	
D0HZ-18124-C	83314		D7HA-18080-AA	83123	89405	E7XZ-18124-C	G63511		F2HZ-18124-C	85006	89401
D1TF-18045-LA	83312	89409	D7HF-18045-FA	83312	89409	E7XZ-18124-D	G63396		F2HZ-18125-A	85712	
D1TZ-18124-D	83308		D7HF-18080-AA	83215		E7XZ-18124-F	G63398		F4HT-18045-AB	83314	
D1TZ-18124-E	83216		D7HF-18125-AA	83215		E7XZ-18124-G	G63398		F4HT-18045-AC	83314	
D1TZ-18124-F	83312	89409	D7HT-18045-BA	83312	89409	E7XZ-18125-A	G63350		F4HT-18045-CB	83107	
D1TZ-18125-E	83217		D7HT-18045-CA	83314		E7XZ-18125-B	G63387		F4HT-18045-DA	85063	
D2EF-18045-AA	83312	89409	D7HT-18045-DA	83309	89446	E7XZ-18125-C	G63409		F4HT-18045-EA	83125	
D2EF-18124-AA	83312	89409	D7HT-18045-EA	83312	89409	E7XZ-18125-D	G63406		F4HT-18080-AA	85314	89425
D2HA-18045-E1A	85304		D7HT-18045-GA	83308		E7XZ-18125-E	G63406		F4HT-18080-AB	85314	89425
D2HA-18045-E1B	85304		D7HT-18045-HA	85012	89413	E7XZ-18125-G	G63811		F4HT-18080-BA	85001	89410
D2HA-18045-E2A	85304		D7HT-18045-JA	83308		E7XZ-18125-J	G63299		F4TA-18045-TA	G63455	
D2HA-18045-E2B	85304		D7HT-18045-NA	85301		E9HS-18045-AA	83309	89446	F4TA-18080-PA	G63461	
D2HA-18045-EB	85301		D7HT-18080-AA	83215		E9HS-18080-AA	85716		F4TZ-18124-D	G63414	
D2HA-18045-F1A	85301		D7HT-18080-BA	83225		E9HZ-18124-A	83309	89446	F4TZ-18124-K	G63455	
D2HA-18045-F1B	85301		D7HT-18080-CA	83225		E9HZ-18125-A	85716		F4TZ-18125-E	G63461	
D2HA-18045-F2A	85301		D7HT-18080-DA	83215		E9HZ-18125-AA	85716		F4TZ-18125-L	G63406	
D2HA-18045-F2B	85301		D7HT-18124-BA	83312	89409	F0HS-18045-AA	85006	89401	F5Z-18125-BB	G63679	
D2HF-18045-A	83314		D7HT-18124-CA	83314		F0HT-18045-AA	85006	89401	F5HZ-18124-A	83314	
D2HF-18045-AA	83314		D7HT-18124-DA	83309	89446	F0HT-18045-CA	85006	89401	F5HZ-18124-AA	83314	
D2HF-18045-BA	83309	89446	D7HT-18124-EA	83312	89409	F0HT-18080-AA	85005	89430	F5HZ-18124-B	83107	
D2HF-18045-CA	83308		D7HT-18124-FA	83312	89409	F0HT-18124-A	85006	89401	F5HZ-18124-C	85063	
D2HF-18045-DA	83312	89409	D7HT-18124-GA	83308		F0HZ-18124-B	85006		F5HZ-18124-D	83125	
D2HF-18124-AA	83314		D7HT-18124-HA	83219		F0HZ-18125-A	85005	89430	F5HZ-18124-DA	83125	
D2HT-18045-CA	83314		D7HT-18124-JA	83308		F1HT-18045-AA	83309	89446	F5HZ-18125-A	85314	89425

**Nota Importante:** Los intercambios deben utilizarse para cuestiones de almacenamiento únicamente. Cuando se identifiquen varios intercambios, consulte la sección de aplicaciones de este catálogo.



## Lista de Intercambios contra Competidores y Equipo Original

### FORD... cont

# E.O.	Fleetline	GasSLX	# E.O.	Fleetline	GasSLX	# E.O.	Fleetline	GasSLX	# E.O.	Fleetline	GasSLX
F5HZ-18125-AA	85314	89425	F6HT-18080-CA	85314	89425	F81A-18080-ZC	83140		TDAA-18080-B	83217	
F5HZ-18125-B	85001	89410	F6HT-18080-DA	83109		F81Z-18124-AL	G63622		TDBA-18045-A	83219	
F5HZ-18125-BA	85001	89410	F6HT-18080-EA	85906	89407	F81Z-18124-BK	G63809		TDBA-18045-B	83219	
F5HZ-18125-DA	85314	89425	F6HT-18080-FC	85013	89414	F81Z-18125-DC	G63461		TDBA-18080-A	83217	
F5TZ-18124-B	G63608		F6HT-18080-JA	85305		F81Z-18125-ZA	83140		TDBA-18080-B	83217	
F5TZ-18125-BC	G63607		F6HZ-18080-FC	85013	89414	F87Z-18125-CA	G63773		TDBA-18080-C	83217	
F5UZ-18124-A	G63622		F6HZ-18124-A	85054	89438	F87Z-18125-RA	G63775		TDBE-18045-A	83219	
F5UZ-18124-B	G63622		F6HZ-18124-B	83308		FC4Z-18124-HB	83135		TFAA-18045-B	83219	
F5UZ-18125-A	G63623		F6HZ-18124-C	85055	89439	LA-18080	83161		TFAA-18045-C	83219	
F5UZ-18125-C	G63624		F6HZ-18124-D	85055	89439	LA-18080-A	83161		TFAA-18080-A	85307	
F6HT-18045-AA	85054	89438	F6HZ-18124-E	85055	89439	LA-18080-B	83161		THAB-18045-A	83219	
F6HT-18045-AC	85054	89438	F6HZ-18124-F	85055	89439	LA-18080-C	83161		THAB-18045-B	83219	
F6HT-18045-BC	85047	89435	F6HZ-18124-G	85054	89438	LA-18080-F	83161		TQSH-18045-A	83309	89446
F6HT-18045-CC	85055	89439	F6HZ-18124-H	85054	89438	LA-18080-J	83161		XC35-18045-AB	83131	
F6HT-18045-EB	85055	89439	F6HZ-18124-J	83200		TAAH-18080-A	83161		XC35-18045-AD	83131	
F6HT-18045-EC	85055	89439	F6HZ-18124-KA	83200		TAAH-18080-A2	83161		XC35-18045-JA	83131	
F6HT-18045-GB	85030	89440	F6HZ-18124-MA	85006	89401	TAAH-18080-A3	83161		XC3Z-18124-JA	83131	
F6HT-18045-GC	85030	89440	F6HZ-18125-A	85314	89425	TAAK-18080-A	83161		XC45-18045-AA	83216	
F6HT-18045-HB	85054	89438	F6HZ-18125-B	83109		TAAK-18080-A1	83161		XL2Z-18124-EA	G63678	
F6HT-18045-HC	85054	89438	F6HZ-18125-C		89441	TAAK-18080-A2	83161		XL2Z-18125-BA	G63679	
F6HT-18045-JB	83200		F6HZ-18125-D	85013	89414	TACAA-18045-A	83216		XL2Z-18125-CA	G63679	
F6HT-18045-JC	83200		F6HZ-18125-JA	85305		TANNA-18045-A	83312	89409	XL2Z-18125-EA	G63679	
F6HT-18045-KA	83200		F7C2Z-18124-BR	G63929		TBAK-18080-A	83161		YL5Z-18124-AA	G63772	
F6HT-18045-LA	85376		F7TA-18045-AA	G63608		TBDA-18080-A	83217				
F6HT-18045-MA	85006	89401	F7TA-18080-BA	G63607		TBDA-18080-B	83217				
F6HT-18080-B	83109		F81A-18080-DCA	G63461		TDAA-18080-A	83161				

### FORD AMORTIGUADORES DE CABINA

# E.O.	Fleetline	GasSLX	# E.O.	Fleetline	GasSLX	# E.O.	Fleetline	GasSLX	# E.O.	Fleetline	GasSLX
1201-0012	83023		1202-0012	83023		1202-0042	83025		F6HZ-5K407-AB	83034	
1201-1043	83025		1202-0022	83046		1202-1043	83025		F6HZ-5K407-BA	83033	
1201-1044	83025		1202-0032	83016		1202-1044	83025		F8HT-5K407-AA	83033	

### FOREST RIVER INC

# E.O.	Fleetline	GasSLX	# E.O.	Fleetline	GasSLX	# E.O.	Fleetline	GasSLX	# E.O.	Fleetline	GasSLX
141700131809	85029		16-16736-000	85029		16-16873-000	85029		16-18103-000	85900	
141700131810	83160		16-16737-000	83160		16-16874-000	83160		481700000493	85900	

### FREIGHTLINER

# E.O.	Fleetline	GasSLX	# E.O.	Fleetline	GasSLX	# E.O.	Fleetline	GasSLX	# E.O.	Fleetline	GasSLX
10-12030-002	85320	89429	10-13759-000	85006		16-15817-000	85724	89443	471700000440	85959	
10-12032-000	85320	89429	10-13760-000	85959		16-16442-000	83134		471700000449	85918	89449
10-12032-001	85320	89429	10-13776-000	85005	89430	16-16486-000	83134		471700000470	85918	89449
10-12032-002	85320	89429	10-13809-000	85958		16-16577-000	85335		471700002391	85959	
10-12032-003	85320	89429	10-13859-000	85005	89430	16-16765-000	85006		471700002808	85724	89443
10-12032-004	85320	89429	10-13934-000	85123		16-16781-000	85108		471700002809	85724	89443
10-12046-000	85320	89429	16-10688-000	85042		16-16782-000	85096		471700002990	85007	89412
10-12388-000	85920		16-11133-000	85007	89412	16-16868-000	85095		471700002991	85959	
10-12390-000	85920		16-12117-000	85007	89412	16-17759-000	85919		471700002992	85331	
10-12542-000	85901		16-13947-000	85319	89428	16-18094-000	85959		471700002993	85921	
10-12594-000	85984		16-13957-000	85724	89443	16-18705-000	85007	89412	471700002994	83134	
10-12703-000	85918	89449	16-14259-000	85331		16-18706-000	85331		471700002995	83134	
10-13021-000	85918	89449	16-14577-000	85043		16-18707-000	85921		471700002996	85335	
10-13051-001	85005	89430	16-14667-000	85005	89430	16-18708-000	85724	89443	471700003009	85006	
10-13063-000	85918	89449	16-14668-000	83127		16-18709-000	83134		471700003920	85958	
10-13205-000	85918	89449	16-14669-000	G63403		16-18710-000	83134		471700006269	85932	89453
10-13211-000	85918	89449	16-14759-000	85000	89436	16-18711-000	85335				
10-13592-000	85959		16-15591-000	85043		16-19138-000	85058	89431			
10-13634-000	85918	89449	16-15765-000	85921		3638112	G63183				
10-13684-000	85918	89449	16-15770-000	85956		4036892	G63605				

**Nota Importante:** Los intercambios deben utilizarse para cuestiones de almacenamiento únicamente. Cuando se identifiquen varios intercambios, consulte la sección de aplicaciones de este catálogo.

## Lista de Intercambios contra Competidores y Equipo Original

### FREIGHTLINER... cont

# E.O.	Fleetline	GasSLX	# E.O.	Fleetline	GasSLX	# E.O.	Fleetline	GasSLX	# E.O.	Fleetline	GasSLX
471700006929	85123		654725	83120		680009	85302	89420	6813260000	83634	
471700131155	85918	89449	654875	83117		680017	85302	89420	6813260200	85011	
471700131331	85932	89453	654918	83118		6803230200	85043		70029	85308	89422
471700131646	85918	89449	659060	85920		6803230300	85006		70042	85302	89420
47902-13	83122	89406	659062	83134		6803260000	83120		90044162	83128	89436
481700125969	85956		659063	83134		680339	85724	89443	90045083	85910	
535228	85302	89420	659300	85005	89430	680442	85319	89428	GBL665538	85006	
58913-003	85932	89453	660235	85042		680511	85331		MK632642	83510	
58913-012	85932	89453	665174	85060		680611	85724	89443	SDA471400003920	85958	
61300224	85918	89449	665236	85007	89412	680651	85335		SDA471700000440	85959	
61300240	85918	89449	665409	85009		680782	85302	89420	SDA471700002809	85724	89443
650224	83225		671908	85918	89449	681-323-0900	85009		SDA471700002991	85959	
651352	85042		671945	85920		681-323-1100	85301		SDA481700125969	85956	
651356	83634		671946	85921		681-326-0400	85319	89428			
654654	85043		680008	85300	89419	6813230900	85009				

### FREIGHTLINER AMORTIGUADORES DE CABINA

# E.O.	Fleetline	GasSLX	# E.O.	Fleetline	GasSLX	# E.O.	Fleetline	GasSLX	# E.O.	Fleetline	GasSLX
1201-0012	83023		18-30378	83006		18-60295-000	83006		654841	83020	
1201-0054	83021		18-30378-000	83001		18-60764-000	83038		654990	83038	
1201-1043	83025		18-31476-000	83020		18-60765-000	83047		659079	83040	
1201-1044	83025		18-32999-000	83001		18-60765-001	83047		659080	83039	
1202-0012	83023		18-32999-001	83006		18-60765-002	83038		659125	83047	
1202-0022	83046		18-37813-000	83044		18-60766-000	83040		659178	83038	
1202-0032	83016		18-41762-000	83038		18-60767-000	83039		659288	83006	
1202-0042	83025		18-41762-001	83047		18-60768-000	83057		681-891-02-05	83017	
1202-0043	83032		18-41762-002	83038		18-60769-000	83009		814903003482	83040	
1202-0044	83025		18-42613-000	83033		18-60772-000	83026		814903003483	83039	
1202-0054	83021		18-43504-000	83057		18-60773-000	83027		814903003484	83057	
1202-1043	83025		18-44321-000	83009		650361	83017		814903003486	83047	
1202-1044	83025		18-45067-000	83034		654739	83009		814903003496	83009	
18-29846-000	83009		18-47349-000	83039		654819	83001		814903003528	83038	
18-29846-001	83064		18-47350-000	83040		654831	83006				

### FREIGHTLINER CUSTOM CHASSIS

# E.O.	Fleetline	GasSLX	# E.O.	Fleetline	GasSLX	# E.O.	Fleetline	GasSLX	# E.O.	Fleetline	GasSLX
10-13358-000	85904		16-15934-000	83120		16-18103-000	85900		654953	85058	89431
10-13759-000	85006		16-16043-000	85043		16-18455-000	85918	89449	659104	85904	
10-13859-000	85005	89430	16-16082-000	85043		16-18713-000	85122		659227	85058	89431
1398980	83127		16-16083-000	85331		16-19138-000	85058	89431	665545401		89430
141700000377	83174		16-16093-000	83160		1745500		89430	6803230300	85006	
141700000378	83160		16-16262-000	83120		471700000447	85919		6803260000	83120	
141700131809	85029		16-16542-000	83154		471700000466	85959		GBL654725	83120	
141700131810	83160		16-16736-000	85029		471700000467	85092		GBL654875	83117	
141700131975	83160		16-16737-000	83160		471700002726	85918	89449	GBL654918	83118	
16-14794-000	83154		16-16765-000	85006		471700003009	85006		GBL665538	85006	
16-15089-000	83164		16-16836-000	83154		471700003011	85058	89431	MAE 16949	83120	
16-15394-000	83120		16-16873-000	85029		471700003070	85122		MAE 16950	83118	
16-15436-000	83154		16-16874-000	83160		471700005079	85005	89430	MAE16950	83118	
16-15473-000	83157		16-17144-000	85900		471700131775	85006		P116168	83117	
16-15474-000	83157		16-17361-000	85900		471700131974	85029		P117099	83120	
16-15475-000	83164		16-17684-000	85058	89431	481700000477	85900		P117146	83118	
16-15592-000	83154		16-17759-000	85919		481700000493	85900		P117253	83116	
16-15676-000	85058	89431	16-18075-000	83174		481700131919	85900		RW24285	83119	
16-15705-000	83120		16-18076-000	83160		651375	83119				
16-15755-000	85043		16-18094-000	85959		654870	83116				
16-15805-000	83120		16-18095-000	85092		654918	83118				

**Nota importante:** Los intercambios deben utilizarse para cuestiones de almacenamiento únicamente. Cuando se identifiquen varios intercambios, consulte la sección de aplicaciones de este catálogo.

## Lista de Intercambios contra Competidores y Equipo Original

### FRUEHAUF

# E.O.	Fleetline	GasSLX	# E.O.	Fleetline	GasSLX	# E.O.	Fleetline	GasSLX	# E.O.	Fleetline	GasSLX
144-5910	85300	89419	UCA-01113	85304		UCE-1295-901	85300	89419	UCF-8339-001	85321	
5116-117	83122	89406	UCA-5431	85305		UCE-2983-000	85322		UCF-8339-002	85321	
5352858	85305		UCD-006216-001	83203	89436	UCE-2983-001	85322		UEY 1124-001	85030	89440
680117	85300	89419	UCD-6216-1	83203	89436	UCE-2983-1	85322				
680298	85321		UCE-1295-1	85300	89419	UCE-9399-1	83122	89406			

### FWD TRUCK

# E.O.	Fleetline	GasSLX	# E.O.	Fleetline	GasSLX	# E.O.	Fleetline	GasSLX	# E.O.	Fleetline	GasSLX
450739	85302	89420									

### GENERAL TRAILER CO

# E.O.	Fleetline	GasSLX	# E.O.	Fleetline	GasSLX	# E.O.	Fleetline	GasSLX	# E.O.	Fleetline	GasSLX
120-1	83125		12608	83125							

### GILLIG BROS.

# E.O.	Fleetline	GasSLX	# E.O.	Fleetline	GasSLX	# E.O.	Fleetline	GasSLX	# E.O.	Fleetline	GasSLX
1583470	85051		57113	83219		82-21542-000	85716		90044683	83122	89406
200-171	85304		57131	83216		82-30159-000	85708		90044769	83207	89407
53-02132	85723		665568	85051		90-1908	85723		90044770	83207	89407
53-02133-000	85318		680009	85302	89420	90-1951-SP1	85734		90045084	85968	
53-13952-000	85722		680333	85708		90-1968	85712		90F-1912	85318	
53-14005-000	85723		695109	85723		90-2164 SP1	85723		H53-02132-14005	85723	
53-14010	85318		695110	85318		90-2423	85723		H53-20415-006	85051	
53-176	85304		70034	85302	89420	90-2627		89461	MR6394	85723	
53-24685	85723		82-01878	83122	89406	90044046	83123	89405			

### GMC TRUCK

# E.O.	Fleetline	GasSLX	# E.O.	Fleetline	GasSLX	# E.O.	Fleetline	GasSLX	# E.O.	Fleetline	GasSLX
1-51630-168-1	G63610		22012065	85304		22064231	85324		3188626	85300	89419
1-51630-217-0	83114		22012067	85700		22064232	85071		3188729	85303	89422
1-51630-217-1	83114		22012079	85701		22064233	83136		3189265	85700	
1-51630-219-1	83114		22012082	85702		22064432	85050		3192333	85700	
12474915	83122	89406	22012083	85711		22064489	85336		3192416	85711	
12474917	83121		22012083GS	85711		22064804	83136		3192657	83216	
15123676	83136		22012090	85308	89422	22064805	83136		3192890	83126	89430
15174898	83136		22012091	85303	89422	22064806	83136		3192891	83221	
15174901	85342		22012095	83126	89430	22064807	83136		3192892	83221	
15174902	85071		22012096	83221		22065218	G63347		35901-0001	83209	89414
15174903	85342		22012114	85700		22065251	85030	89440	35901-0003	85301	
15185643	83153		22012131	85711		22099889	85336		35901-0004	83219	
15185644	83155		22012166	83126	89430	2212169	83221		35901-0005	83219	
15588554	83136		22012169	83221		22165187	83136		35901-0017	83314	
15642943	83136		22012196	83221		22165188	83136		37301-0016	85026	89417
15740554	83121		22017530	83303		22165189	83136		37301-0021	85026	89417
15887728	83136		22017531	83303		22166442	83136		37301-3202	85026	89417
1591501	85722		22024061	85704		3082284	83400		4939852	85308	89422
15963161	83122	89406	22024062	85701		3166657	85700		4939967	85308	89422
19152843	83136		22024673	85710		3171068	83216		4940600	83209	89414
21998392	85336		22025067	85704		3171069	85304		4940601	83216	
22002293	83126	89430	22025305	85704		3171462	83126	89430	4940606	83126	89430
22002294	83304		22045526	85702		3171696	85307		4940614	83216	
22002295	83303		22046481	85702		3172948	85303	89422	4940627	83203	89436
22007701	83126	89430	22046483	85304		3175509	85735		4940640	83216	
22007702	83304		22046485	85710		3178106	85700		4940650	83207	89407
22007703	83303		22046489	85303	89422	3178157	85700		4940654	83216	
22007750	83207	89407	22046499	85710		3178233	85734		4940660	83207	89407
22007751	83303		22052014	85702		3178507	85700		4940662	83126	89430
22007752	83304		22052336	85304		3178995	85700		4963844	85307	
22007753	83303		22052424	85710		3182842	85711		4963853	83216	
22007757	83304		22064230	83136		3188599	85711		4963854	83216	

**Nota Importante:** Los intercambios deben utilizarse para cuestiones de almacenamiento únicamente. Cuando se identifiquen varios intercambios, consulte la sección de aplicaciones de este catálogo.

## Lista de Intercambios contra Competidores y Equipo Original

### GMC TRUCK... cont

# E.O.	Fleetline	GasSLX	# E.O.	Fleetline	GasSLX	# E.O.	Fleetline	GasSLX	# E.O.	Fleetline	GasSLX
4964853	83217		5355798	85307		5549899	83207	89407	88982682	83136	
4974401	85700		5357955	85300	89419	5549924	85700		88982684	83136	
4975429	85300	89419	5357956	85734		5549925	85304		88982685	85342	
4975467	83207	89407	5357959	85300	89419	5552111	85304		88982686	85071	
4975472	83161		5361994	85734		5552112	85307		88982687	85342	
4975479	83400		5374779	85308	89422	5552114	83216		88982688	85336	
4975480	83400		5374999	85307		5552205	83217		898098-0580	83159	
4975494	83207	89407	5385939	85307		5552206	83214		898098-0590	83159	
4975497	83126	89430	5392387	85303	89422	5552207	83217		898098-1250	83515	
4975501	85700		5394448	85305		5552208	83217		898098-1270	83515	
4975510	83221		5394467	85305		5552209	83215		9-51630-647-1	G63616	
4975511	83303		5394468	85735		5552210	85308	89422	9-51630-666-0	85012	89413
4975515	85701		5455798	85307		5552244	85308	89422	9-51630-666-2	85012	89413
4975516	85702		5513489	83216		5552285	83214		90044769	83207	89407
4975518	85704		5513716	85304		5552286	83217		90044770	83207	89407
4975538	85700		5516459	85305		5552287	83217		94033786	83114	
4975549	83216		5522781	85735		5552288	83217		94051090	83114	
4975550	85702		5522794	85308	89422	5552451	85308	89422	94057593	83114	
4975552	85711		5522818	85305		5552452	85303	89422	94454987	G63616	
4984526	83216		5527001	85300	89419	5552453	85301		97-2210-00153	85701	
507-12	85701		5527271	85700		5552454	85302	89420	97-2210-00156	85702	
507-16	85702		5527272	85700		5552456	85307		97-2210-00164	85708	
507-19	85700		5527606	85305		5552527	85735		97-2210-00170	85733	
507-22	85342		5531027	85301		5554184	85302	89420	97083027	G63616	
507-23	85342		5531435	85307		5554589	85307		97083029	G63616	
507-24	85336		5531436	85307		5554596	85303	89422	97201960	G63616	
508-88	83153		5531437	85307		5554814	85302	89420	97253616	83515	
508-89	83155		5532026	85304		5554959	83401		97253620	83515	
5171068	83216		5532425	83207	89407	5554995	85305		97253621	83515	
5304059	85700		5532433	83207	89407	5559363	83203	89436	97253623	83515	
5316784	85700		5532675	85307		55585939	85307		97253651	83404	
5316791	83219		5533699	85302	89420	684280	83209	89414	97253664	83159	
5316792	85305		5534430	85303	89422	8-51630-666-0	85012	89413	97253665	83159	
5316793	85305		5534439	85304		8-94057-593-0	83114		98018780	83508	
5316794	85700		5534447	85303	89422	8-94454-986-0	G63616		98093668	83508	
5316984	85313		5544060	85302	89420	8-94454-987-0	G63616		98098058	83159	
5321920	85307		5544112	83216		8-97083-029-0	G63616		98098059	83159	
5321929	85307		5544581	85302	89420	8-97201-960-0	G63616		98098125	83515	
5348631	83203	89436	5544716	85304		8-97253664-0	83159		98098127	83515	
5352857	85700		5544717	85304		8-97253665-0	83159		98197653	83179	
5352858	85305		5544812	83308		87-2520-00003	85704		L-12706	83155	
5353054	85303	89422	5544818	85735		88963409	85336		U0109-014	83400	

### GMC TRUCK AMORTIGUADORES DE CABINA

# E.O.	Fleetline	GasSLX	# E.O.	Fleetline	GasSLX	# E.O.	Fleetline	GasSLX	# E.O.	Fleetline	GasSLX
1201-1043	83025		1202-0022	83046		1202-0054	83021				
1202-0012	83023		1202-0032	83016		1202-1043	83025				

### GRANNING SUSPENSION

# E.O.	Fleetline	GasSLX	# E.O.	Fleetline	GasSLX	# E.O.	Fleetline	GasSLX	# E.O.	Fleetline	GasSLX
1085	83214		680162	85300	89419	OE12425	83214				
2697	85712		701071-01	646155							

### GREAT DANE TRAILER

# E.O.	Fleetline	GasSLX	# E.O.	Fleetline	GasSLX	# E.O.	Fleetline	GasSLX	# E.O.	Fleetline	GasSLX
18163-01	83207	89407	HENS-20001	83128	89436	HENS-21292	85052		HENS-24088	85000	89436
18164-01	83122	89406	HENS-20002	85000	89436	HENS-23566	85000	89436	MER202447	85919	
18165-01	85006		HENS-20126	85323	89436	HENS-23649	85064		REY18165-01	85006	

**Nota Importante:** Los intercambios deben utilizarse para cuestiones de almacenamiento únicamente. Cuando se identifiquen varios intercambios, consulte la sección de aplicaciones de este catálogo.

## Lista de Intercambios contra Competidores y Equipo Original

### GREYHOUND BUS

# E.O.	Fleetline	GasSLX	# E.O.	Fleetline	GasSLX	# E.O.	Fleetline	GasSLX	# E.O.	Fleetline	GasSLX
12B-5-1	85735		3166657	85700		3178157	85700		690029	85700	
12TA-01-013	85303	89422	3178154	85735		3192333	85700		74413	85313	

### GRUMMAN BUS

# E.O.	Fleetline	GasSLX	# E.O.	Fleetline	GasSLX	# E.O.	Fleetline	GasSLX	# E.O.	Fleetline	GasSLX
22024506	85703		690029	85700		97-2201-00004	85703		97-2210-00003	85704	
22025066	85703		97-2201-00001	85703		97-2201-00005	85703		97-2210-00004	85704	
22025067	85704		97-2201-00002	85703		97-2210-00001	85704		97-2210-00005	85704	
22025305	85704		97-2201-00003	85703		97-2210-00002	85704				

### GULF STREAM COACH

# E.O.	Fleetline	GasSLX	# E.O.	Fleetline	GasSLX	# E.O.	Fleetline	GasSLX	# E.O.	Fleetline	GasSLX
141700131809	85029		16-16736-000	85029		16-16873-000	85029		16-18103-000	85900	
141700131810	83160		16-16737-000	83160		16-16874-000	83160		481700000493	85900	

### HARDEE MFG

# E.O.	Fleetline	GasSLX	# E.O.	Fleetline	GasSLX	# E.O.	Fleetline	GasSLX	# E.O.	Fleetline	GasSLX
8030223	83207	89407	AS789B	85014							

### HAUSMAN

# E.O.	Fleetline	GasSLX	# E.O.	Fleetline	GasSLX	# E.O.	Fleetline	GasSLX	# E.O.	Fleetline	GasSLX
695110	85318		695119	85702		695198	85706				

### HENDRICKSON TRAILER SUSPENSION SYSTEMS

# E.O.	Fleetline	GasSLX	# E.O.	Fleetline	GasSLX	# E.O.	Fleetline	GasSLX	# E.O.	Fleetline	GasSLX
57905-2	85006		680570		89437	A-2471	85006		B-25436	85916	89430
654951	85000	89436	680571	85738		A-4084	85005	89430	B-25437	85337	
659024	85052		680573	85939		A-4089	83209	89414	B-25515	85338	
665190	85006		680579	85939		A-4890	85712		B-26652	85000	89436
665246	85043		680614	85338		A-6156	85301		B-27058	83128	
665267	85029		680616		89430	B-20345	85345		B-27747	85911	
665405	85030	89440	680617	85337		B-21553	85738		B-29432	85323	89436
665406	85010		680702	85323	89436	B-21699	87018		B-29678	85911	
665531	85000	89436	680756	85323	89436	B-21832	85323	89436	B-29826	85338	
665532	85013	89414	680769	85911		B-21936	85064		NS500699	85005	89430
665533	85005	89430	680776	85338		B-21947	85052		S-10348	85043	
665536	85000	89436	98583-019	85323	89436	B-21994	85938		S-14583	85000	89436
665693	85064		98583-020		89414	B-22311	85045		S-1667	85000	89436
665694	85052		A-10023	85000	89436	B-22312	85939		S-1668	85000	89436
665698	85911		A-10348	85043		B-22345	85911		S-20001	83128	89436
665733	85045		A-11931	85000	89436	B-22715	85323	89436	S-20002	85000	89436
665756	85000	89436	A-14496	646155		B-22862	85045		S-20126	85323	89436
665758	85064		A-14583	85000	89436	B-23013	85000	89436	S-20345	85345	
665759	85052		A-1667	85000	89436	B-23014	85738		S-20886	85030	89440
665760	85045		A-1668	85000	89436	B-23290	83150		S-20887	85005	89430
665761	85911		A-20001	83128	89436	B-23315	85029		S-20889	85323	89436
665763	85079		A-20002	85000	89436	B-23316	85382		S-21292	85052	
665764	85029		A-20126	85323	89436	B-23361	85911		S-21553	85738	
665765	83150		A-20345	85345		B-23362		89437	S-2160	85014	
665766	85000	89436	A-20886	85030	89440	B-23548	85079		S-21699	87018	
665767	85045		A-20887	85005	89430	B-23566	85000	89436	S-21832	85323	89436
671779		89414	A-20889	85323	89436	B-23649	85064		S-21936	85064	
671948	85000	89436	A-21292	85052		B-23650	85052		S-21947	85052	
680102	85712		A-2160	85014		B-23651	85045		S-2212	85029	
680341	85323	89436	A-2212	85029		B-23743	85938		S-2213	85010	
680463		89440	A-2213	85010		B-23744	85344		S-2218	85030	89440
680467	85323	89436	A-2218	85030	89440	B-24023	85738		S-2230	85005	89430
680509	85738		A-2230	85005	89430	B-24088	85000	89436	S-22311	85045	
680565	85738		A-2232	85005	89430	B-24125	85323	89436	S-22312	85939	
680566	85938		A-2240	85013	89414	B-24579	85939		S-2232	85005	89430
680568	85323	89436	A-2240-1	85043		B-25174	85029		S-22345	85911	

**Nota Importante:** Los intercambios deben utilizarse para cuestiones de almacenamiento únicamente. Cuando se identifiquen varios intercambios, consulte la sección de aplicaciones de este catálogo.

# Lista de Intercambios contra Competidores y Equipo Original

## HENDRICKSON TRAILER SUSPENSION SYSTEMS... cont

# E.O.	Fleetline	GasSLX	# E.O.	Fleetline	GasSLX	# E.O.	Fleetline	GasSLX	# E.O.	Fleetline	GasSLX
S-2240	85013	89414	S-23361	85911		S-23744	85344		S-25515	85338	
S-22715	85323	89436	S-23362		89437	S-24023	85738		S-26652	85000	89436
S-22862	85045		S-23548	85079		S-24088	85000	89436	S-29432	85323	89436
S-23013	85000	89436	S-23566	85000	89436	S-24125	85323	89436	S-29678	85911	
S-23014	85738		S-23649	85064		S-24579	85939		S-29826	85338	
S-23290	83150		S-23650	85052		S-2471	85006		S-4084	85005	89430
S-23315	85029		S-23651	85045		S-25436	85916	89430	S-4089	83209	89414
S-23316	85382		S-23743	85938		S-25437	85337		S-4890	85712	

## HENDRICKSON TRUCK SUSPENSION SYSTEMS

# E.O.	Fleetline	GasSLX	# E.O.	Fleetline	GasSLX	# E.O.	Fleetline	GasSLX	# E.O.	Fleetline	GasSLX
12738	83225		59057-001	83137		60670-014	83166		659000	83148	
471700000456	85959		59057-002	85036	89405	60670-017	83148		659004	83123	89405
471700006269	85932	89453	59305-1	85979		60670-018	83166		659048	83143	
471700131545	85006		59483-000	85919		60670-019	83166		659049	83142	
47902-11	83207	89407	59851-1	85976		60670-020	83148		659155	83147	
47902-13	83122	89406	59852-1	85977		60670-12	83168		659202	83148	
47902-15	83121		59852-2	85977		60675-001	85978		659292	83148	
47902-18	85030	89440	60657-003	85072		60675-002	85979		65992-001	85955	
47902-19	83123	89405	60657-005	85087		60675-003	85976		65992-002	85955	
47902-24	83121		60657-006	85102		60675-005	85980		65992-003	85959	
47902-25	83125		60657-007	85072		60675-006	85909		65992-006	85986	
47902-26	83144		60657-010	85102		60675-8Q	85976		665816	85072	
47902-27	83123	89405	60657-011	85102		60680-001	83111		665892	85072	
47902-28	85013	89414	60665-003	83137		60680-002	83109		671006	85036	89405
47902-29	83149		60665-004	85036	89405	60680-003	83112		671007	83137	
47902-3	85005	89430	60665-005	85919		60680-004	83143		671009	85919	
47902-8	83122	89406	60665-008	85978		60680-005	83142		671030	85083	
47902-9	83123	89405	60665-009	85904		60680-009	85083		671063	85083	
503610C2	83207	89407	60665-011	85967		60680-012	85083		671105	85072	
5554596	85303	89422	60665-013	85965		60685-001	85977		671603	85919	
57241-001	83111		60665-014	85962		60998-001	85006		671606	85955	
57241-002	83109		60665-015	85966		60998-002	85919		671611	85955	
57241-003	83112		60665-018	85961		60998-003	85006		671704	85904	
57241-004	83110		60665-020	85919		64838-001	85933	89454	671764	85967	
57241-006	83111		60665-024	85903		64838-001L	85933	89454	671792	85965	
57324-11	85305		60665-025	85036		64838-002	85933	89454	671793	85966	
57324-5	85903		60670-001	83123	89405	64838-002L	85933	89454	671798	85962	
57324-6	85904		60670-002	83207	89407	64838-003	85933	89454	672009	85903	
57905-1	85976		60670-003	83149		654890	83207	89407	680091	85303	89422
58623-1	85978		60670-004	83123	89405	654891	83149		680600	85305	
58913-003	85932	89453	60670-005	83121		654894	83123	89405	70018	85303	89422
58913-007	85959		60670-006	83147		654895	83137		70021	85303	89422
58913-007L	85959		60670-007	83144		654896	83147		70088	85307	
58913-008	85959		60670-008	83123	89405	654897	83144		98583-006	83148	
58913-008L	85959		60670-008L	83123	89405	654898	83123	89405	98583-016	83147	
58913-009	85959		60670-009	85013	89414	654899	85013	89414	AE76164-3	85307	
58913-009L	85959		60670-010	83149		654900	83149		AE76164-4	83225	
58913-011	85959		60670-011	83148		654903	83111		BE76164-2	85303	89422
58913-012	85932	89453	60670-012	83168		654904	83109		BE76164-3	85307	
59048-001	83148		60670-013	83148		654905	83112		BE76164-4	83225	

## HIGHWAY PRODUCT

# E.O.	Fleetline	GasSLX	# E.O.	Fleetline	GasSLX	# E.O.	Fleetline	GasSLX	# E.O.	Fleetline	GasSLX
A1-6-134	83207	89407	A1-6-135	83203	89436						

## HINO

# E.O.	Fleetline	GasSLX	# E.O.	Fleetline	GasSLX	# E.O.	Fleetline	GasSLX	# E.O.	Fleetline	GasSLX
34802	83216		48500-1801	83216							
48500-1800	83216		48500-1940	83141							

**Nota Importante:** Los intercambios deben utilizarse para cuestiones de almacenamiento únicamente. Cuando se identifiquen varios intercambios, consulte la sección de aplicaciones de este catálogo.

## Lista de Intercambios contra Competidores y Equipo Original

### HINO... cont

# E.O.	Fleetline	GasSLX	# E.O.	Fleetline	GasSLX	# E.O.	Fleetline	GasSLX	# E.O.	Fleetline	GasSLX
48500-1941	83141		48511-89215	83514		48531-37200	83505		S4850-02750	G63610	
48500-1950	G63610		48530-1120	83104		48531-37210	83511		S4850-03430	83507	
48500-2750	G63610		48530-1460	83215		48531-37270	83404		S4850-03680	85118	
48500-3430	83507		48530-1620	83104		48531-37380	83506		S4850-03700	85118	
48500-3680	85118		48530-1770	83215		48531-80745	83511		S4850-03710	83126	89430
48500-3710	83126	89430	48530-1880	83362		60670-013	83148		S4850-03720	83140	
48500-3720	83140		48530-1890	83104		60670-014	83166		S4853-01900	83104	
485003710A	83126	89430	48530-1900	83104		60670-018	83166		S4853-01910	83216	
48511-37260	83514		48530-1910	83216		60670-019	83166		S4853-02510	83216	
48511-37280	83512		48530-2050	83217		60670-020	83148		S4853-03280	G63440	
48511-37290	83513		48530-2510	83216		66639	G63610				
48511-80123	83512		48530-3280	G63440		S4850-01941	83141				
48511-80130	83513		48530E0100	83166		S4850-01950	G63610				

### HOBBS TRAILERS

# E.O.	Fleetline	GasSLX	# E.O.	Fleetline	GasSLX	# E.O.	Fleetline	GasSLX	# E.O.	Fleetline	GasSLX
680117	85300	89419									

### HOLIDAY RAMBLER

# E.O.	Fleetline	GasSLX	# E.O.	Fleetline	GasSLX	# E.O.	Fleetline	GasSLX	# E.O.	Fleetline	GasSLX
90044794	83127		U0109-007	G63183							

### HOLLAND - BINKLEY

# E.O.	Fleetline	GasSLX	# E.O.	Fleetline	GasSLX	# E.O.	Fleetline	GasSLX	# E.O.	Fleetline	GasSLX
680298	85321		6898	83125							

### HUTCHENS SUSPENSION

# E.O.	Fleetline	GasSLX	# E.O.	Fleetline	GasSLX	# E.O.	Fleetline	GasSLX	# E.O.	Fleetline	GasSLX
9423-00	83203	89436									

### HYSTER

# E.O.	Fleetline	GasSLX	# E.O.	Fleetline	GasSLX	# E.O.	Fleetline	GasSLX	# E.O.	Fleetline	GasSLX
650150	83217		73516	83217							

### IC CORPORATION

# E.O.	Fleetline	GasSLX	# E.O.	Fleetline	GasSLX	# E.O.	Fleetline	GasSLX	# E.O.	Fleetline	GasSLX
2200327C1	85332		3578858C2	85926		3902993C3	83135		65992-006	85986	
3533356C3	83169		3605735C1	83156		472412C91	83456	89447	OE13402S	83163	
3578105C1	83163		3605735C2	83156		501906C91	83317		OE13424S	83317	
3578105C2	83163		3902993C2	83135		501906C92	83317				

### INGERSALL MACHINE

# E.O.	Fleetline	GasSLX	# E.O.	Fleetline	GasSLX	# E.O.	Fleetline	GasSLX	# E.O.	Fleetline	GasSLX
665472	665472		665904	665472							

### INGERSOLL AXLES

# E.O.	Fleetline	GasSLX	# E.O.	Fleetline	GasSLX	# E.O.	Fleetline	GasSLX	# E.O.	Fleetline	GasSLX
653511-01	85323	89436	653511-02	85938		653511-03	85045		653511-04	85052	

### INTERNATIONAL (NAVISTAR)

# E.O.	Fleetline	GasSLX	# E.O.	Fleetline	GasSLX	# E.O.	Fleetline	GasSLX	# E.O.	Fleetline	GasSLX
1660846C91	83101		2018987C1	85003	89411	210536R91	83225		306444C91	85012	89413
1660846C92	83101		2018987C2	85003	89411	210537R91	83225		3085640C92	83216	
1663471C1	83103		2029200C91	83126	89430	210538R91	83225		308646C91	85012	89413
1663606C91	85027	89418	2029200C91	85030	89440	210918R91	83215		308648C91	83225	
1664149C1	85029		2032533C1	85316	89426	210919R91	85307		308649C91	83216	
1664524C1	85935		2039549C1	85333		210920R91	85308	89422	308650C91	83216	
1664788C2	85316	89426	2039565C1	83100		2200327C1	85332		308650C92	83216	
1667520C1	85058	89431	204994R91	83225		287318C91	G63306		308664C91	85307	
1675455C1	85003	89411	206620R91	83216		288920C91	83225		308668C91	85012	89413
1675496C91	83636		206621R91	83216		288921C91	83225		308668C92	85012	89413
1675496C92	83636		206621R92	83216		288921R92	83225		308669C91	85012	89413
1677707C1	85030	89440	208664C91	85307		293009C91	85308	89422			
1690035C1	85003	89411	210533R91	83225		294334C91	83216				
2015556C1	85316	89426	210534R92	83225		3000070C91	83456	89447			
2015557C1	85030	89440	210535R91	83225		3000098C1	83317				

**Nota Importante:** Los intercambios deben utilizarse para cuestiones de almacenamiento únicamente. Cuando se identifiquen varios intercambios, consulte la sección de aplicaciones de este catálogo.

## Lista de Intercambios contra Competidores y Equipo Original

### INTERNATIONAL (NAVISTAR)... cont

# E.O.	Fleetline	GasSLX	# E.O.	Fleetline	GasSLX	# E.O.	Fleetline	GasSLX	# E.O.	Fleetline	GasSLX
320444C91	85012	89413	3586902C2	83146		3892445C3	85931	89458	501906C92	83317	
329316C92	85012	89413	3586902C3	83146		3902993C1	83167		503550C1	83207	89407
350425C1	85300	89419	3588209C1	85957		3902993C3	83135		503610C1	83207	89407
350426C1	85734		3588209C2	85957		3914952C1	85976		503610C2	83207	89407
350426C91	85734		3588591C1	85953		426744R91	85303	89422	507202C1	85030	89440
3514952C1	85976		3588591C2	85953		426744R92	85303	89422	534464C1	85734	
3533356C1	83135		3588592C1	85953		446-51-211	85739		537524C91	83123	89405
3533356C2	83135		3588592C2	85953		452566C91	83225		537525C91	83123	89405
3533356C3	83169		3596107C1	85927		453527C91	85311	89424	540395C91	83613	
3533357C1	85957		3596107C2	85927		453528C91	85311	89424	540395C92	83613	
3533357C2	85957		3601600C1	85082		453531C91	G63306		548532C1	83103	
3533357C3	85957		3601600C2	85082		453556C91	85012	89413	56101 Z1030	85311	89424
3541456C1	85929		360444C91	85012	89413	453557C91	G63306		56101 Z2000	85311	89424
3544766C1	85930		3605735C1	83156		453561C91	83225		56101 Z5008	83114	
3544768C1	85926		3605735C2	83156		453562C91	83225		56101 Z5011	G63610	
3549099C1	85923	89458	3606770C1	83163		453564C91	85012	89413	56110-T8123	G63432	
3549099C2	85923	89458	3606770C2	83163		453565C91	83225		56110-T8129	G63432	
3549100C1	85926		3606857C1	85954		453566C91	83225		586724C91	83456	89447
3553628C1	85927		3606857C2	85954		453567C91	83216		596329C1	85014	
3553628C2	85927		3606857C3	85994		453568C91	83225		60657-003	85072	
3553628C3	85927		3606859C1	85954		453569C91	83225		60657-006	85102	
3558089C1	85925		3606859C2	85954		453570C91	83216		60657-010	85102	
3558089C2	85925		3606859C3	85994		453571C91	83216		60657-011	85102	
3558089C3	85925		3609178C1	85955		453572C91	83309	89446	60670-007	83144	
3558989C1	85925		3609400C1	83317		453574C91	85307		60675-003	85976	
3558989C2	85925		3609400C2	83317		453575C91	83308		60680-003	83112	
3571711C1	85316	89426	3610198C1	85963		453576C91	85303	89422	60680-004	83143	
3571713C1	85333		3610199C1	85964		453576C92	85303	89422	65992-001	85955	
3573265C1	85931	89458	3613984C1	85955		453577C91	85308	89422	65992-002	85955	
3576464C1	85957		3620395C1	85931	89458	453579C91	85308	89422	66400	G63432	
3576464C2	85957		3626571C1	85072		453597C91	83216		6E7Z-18125-A	83146	
3576465C2	85999		3660548C1	85955		462557C91	85300	89419	70334	85316	89426
3578105C1	83163		3660549C1	85955		462603C91	85705	89447	790335C91	83209	89414
3578105C2	83163		3668566C1	85954		462753C91	83216		800670	85060	
3578858C1	85926		3670156C1	85954		463926C91	85705	89447	873619C92	83314	
3578858C2	85926		3674348C1	85954		467371C91	83225		873619C93	83314	
3581106C1	85924	89457	3688614C1	85923	89458	467372C91	83225		873622C91	83308	
3581106C2	85924	89457	3688616C1	85923	89458	467980C91	G63306		874695R91	85012	89413
3581106C3	85924	89457	3688729C1	85931	89458	467983C91	85012	89413	874695R92	85012	89413
3581107C1	85924	89457	3688732C1	85931	89458	467984C91	83216		874696R91	85012	89413
3581107C2	85924	89457	3737575C1	85954		467985C91	85012	89413	90044025	83209	89414
3581107C3	85924	89457	3737576C1	85931	89458	471201C91	85012	89413	90044626	83126	89430
3581109C1	85924	89457	3806341C3	85995		471203C91	83308		AMS 600102	85005	89430
3581109C3	85924	89457	3810581C4	85995		472367C91	83318		AMS 600172	83126	89430
3581109C4	85924	89457	3813340C1	85964		472411C91	83456	89447	AMS 600172	85030	89440
3584116C1	83175		3813340C2	85964		472412C91	83456	89447	AMS 650420	85013	89414
3584116C2	83175		3813340C3	85964		472414C91	83318		AMS650102	85001	89410
3584117C1	83135		3813341C1	85963		474002C91	83308		AMS650107	85316	89426
3584117C2	83135		3813341C2	85963		477132C1	85303	89422	AMS650400	85033	89427
3584118C1	85928		3813341C3	85963		47902-24	83121		AMS650402	85311	89424
3584118C2	85928		3816234C1	85999		4C4Z-18124-N	85957		AMS650404	85310	89423
3584535C1	85924	89457	3819277C1	85969		4C4Z-18125-DA	85926		AMS650405	85023	89415
3584535C2	85924	89457	3819279C1	85969		501506C91	83317		AMS650406	85024	89416
3584535C3	85924	89457	383379C91	83308		501553C91	85003	89411	AMS650408	85319	89428
3586706C2	83145		384435C91	83216		501905C91	83301		AMS650420	85013	89414
3586883C1	85931	89458	3868264C1	85998		501906C91	83317		H60657-003	85072	

**Nota Importante:** Los intercambios deben utilizarse para cuestiones de almacenamiento únicamente. Cuando se identifiquen varios intercambios, consulte la sección de aplicaciones de este catálogo.



## Lista de Intercambios contra Competidores y Equipo Original

### INTERNATIONAL (NAVISTAR)... cont

# E.O.	Fleetline	GasSLX	# E.O.	Fleetline	GasSLX	# E.O.	Fleetline	GasSLX	# E.O.	Fleetline	GasSLX
H60657-006	85102		H60657-011	85102		OE 18513	83135		OE13424S	83317	
H60657-010	85102		H60675-003	85976		OE13402S	83163		OE17103	83167	

### INTERNATIONAL (NAVISTAR) AMORTIGUADORES DE CABINA

# E.O.	Fleetline	GasSLX	# E.O.	Fleetline	GasSLX	# E.O.	Fleetline	GasSLX	# E.O.	Fleetline	GasSLX
1201-0012	83023		1201-9018	83062		2500013C1	83013		2597458C91	83062	
1201-0154	83051		1201-9021	83062		2503529C1	83025		2600491C91	83062	
1201-0254	83051		1202-0012	83023		2507409C1	83052		2601488C91	83062	
1201-1043	83025		1202-0022	83046		2507761C1	83052		2602021C1	83062	
1201-1044	83025		1202-0032	83016		2507763C1	83052		3557165C1	83053	
1201-1049	83025		1202-0042	83025		2507948C1	83054		3557166C1	83052	
1201-1212	83013		1202-0043	83032		2508326C1	83021		3557167C3	83053	
1201-1213	83005		1202-0044	83025		2508327C1	83025		3557169C1	83052	
1201-9001	83052		1202-0054	83021		2509221C91	83054		3557169C2	83052	
1201-9002	83052		1202-1043	83025		2509222C91	83053		3560649C1	83052	
1201-9003	83052		1202-1044	83025		2509223C91	83054		3560649C2	83052	
1201-9007	83054		1202-1212	83013		2509224C91	83053		3560705C2	83054	
1201-9008	83054		1202-1213	83005		2585145C1	83051		480945C1	83014	
1201-9009	83054		2012768C1	83013		2589922C1	83051		480945C2	83014	
1201-9010	83053		2012769C2	83005		2590915C1	83062		AMS66160	83052	
1201-9011	83053		2023684C1	83015		2590916C1	83062		AMS66161	83053	
1201-9013	83062		2023685C1	83015		2593803C91	83062		OE14771	83062	
1201-9014	83062		2025790C1	83013		2595314C1	83062				

### ISUZU

# E.O.	Fleetline	GasSLX	# E.O.	Fleetline	GasSLX	# E.O.	Fleetline	GasSLX	# E.O.	Fleetline	GasSLX
1-51630-168-1	G63610		60670-005	83121		8-97253-621-0	83515		9-51630-647-1	G63616	
1-51630-217-0	83114		8-22064-231-0	85324		8-97253-623-0	83515		9-51630-666-0	85012	89413
1-51630-217-1	83114		8-22064-232-0	85071		8-97253-651-2	83404		9-51630-666-2	85012	89413
1-51630-219-1	83114		8-22064-233-0	83136		8-97253-664-0	83159		94033786	83114	
12474915	83122	89406	8-22064-489-0	85336		8-97253-665-0	83159		94454986	G63616	
15123676	83136		8-22064-804-0	83136		8-98018780-0	83508		94454987	G63616	
15174902	85071		8-22064-805-0	83136		8-98093-668-0	83508		97083027	G63616	
15887728	83136		8-22064-806-0	83136		8-98098-058-0	83159		97083029	G63616	
19152843	83136		8-22064-807-0	83136		8-98098-059-0	83159		97253620	83515	
441133	83515		8-51630-666-0	85012	89413	8-98098-125-0	83515		97253651	83404	
444329	83509		8-94454-647-1	G63616		8-98098-127-0	83515		97253664	83159	
51630168	G63610		8-94454-986-0	G63616		8-98098059-0	83159		97253665	83159	
51630217	83114		8-94454-987-0	G63616		8-98197-653-0	83179		98098058	83159	
51630219	83114		8-97083-027-0	G63616		88982682	83136		98098059	83159	
51630647	G63616		8-97083-029-0	G63616		88982686	85071		98098125	83515	
51630666	85012	89413	8-97253-605-0	83509		8972019600	G63616		98098127	83515	
5872000730	83509		8-97253-616-0	83515		898098-1250	83515				
5872001100	83515		8-97253-620-0	83515		898098-1270	83515				

### ITASCA

# E.O.	Fleetline	GasSLX	# E.O.	Fleetline	GasSLX	# E.O.	Fleetline	GasSLX	# E.O.	Fleetline	GasSLX
141700131809	85029		16-16736-000	85029		16-16873-000	85029		16-18103-000	85900	
141700131810	83160		16-16737-000	83160		16-16874-000	83160		481700000493	85900	

### JAY MADSEN

# E.O.	Fleetline	GasSLX	# E.O.	Fleetline	GasSLX	# E.O.	Fleetline	GasSLX	# E.O.	Fleetline	GasSLX
3166657	85700		3192333	85700							

### JIFFLOX

# E.O.	Fleetline	GasSLX	# E.O.	Fleetline	GasSLX	# E.O.	Fleetline	GasSLX	# E.O.	Fleetline	GasSLX
CP-5222	85315										

### JOHN DEERE

# E.O.	Fleetline	GasSLX	# E.O.	Fleetline	GasSLX	# E.O.	Fleetline	GasSLX	# E.O.	Fleetline	GasSLX
3638112	G63183		4036892	G63605							

**Nota Importante:** Los intercambios deben utilizarse para cuestiones de almacenamiento únicamente. Cuando se identifiquen varios intercambios, consulte la sección de aplicaciones de este catálogo.

## Lista de Intercambios contra Competidores y Equipo Original

### KENWORTH

# E.O.	Fleetline	GasSLX	# E.O.	Fleetline	GasSLX	# E.O.	Fleetline	GasSLX	# E.O.	Fleetline	GasSLX
02-02736PLUS	85302	89420	665784	83122	89406	680473	85319	89428	C71-1013	85985	
02-02737PLUS	85062	89408	665785	83137		680475	85314	89425	C71-1014	85936	89456
02-02738PLUS	85012	89413	665788	85000	89436	680476	85310	89423	C71-1015	85937	
02-02739PLUS	85013	89414	665828	85067	89451	680486	85310	89423	C71-1015 PLUS	85937	
03-04176PLUS	85308	89422	665844	85069	89455	680586	85311	89424	C71-1015A	85937	
03-06084PLUS	85033	89427	665858	85070	89459	70701	85900		C71-1016	85067	89451
03-07421PLUS	85311	89424	665903	85900		70701PLUS	85900		C71-1017	85069	89455
03-07423PLUS	85033	89427	665906	85902		8086053PLUS	85047	89435	C71-6003	85988	
10-12032-002PLUS	85320	89429	665918	85900		90044025PLUS	83209	89414	C71-6004	85343	
10-12542-000PLUS	85901		665926	85047	89435	90044089	83124	89407	C71-6005	85069	89455
16-13947-000PLUS	85319	89428	665927	85901		90044089PLUS	83124	89407	K374-11	85001	89410
16725-01	83221		665928	85062	89408	90045068		89441	K374-13	83353	
19495-01	83126	89440	665930	85001	89410	90045099	85906	89407	K374-13-1	83353	
2018987C1PLUS	85003	89411	665931	83312	89409	90045132	85909		K374-14	83312	89409
3166657	85700		665932	85012	89413	90045605	85109		K374-15	83353	
471700004423	85109		665944	85900		ACHB966	83136		K374-16	85001	89410
47902-13PLUS	83122	89406	665945	85902		B71-1000	85031		K374-26	85001	89410
47902-19	83123	89405	665950	85902		B71-1001	85070	89459	K374-26PLUS	85001	89410
47902-24	83121		671052	85070	89459	B71-1002	85001	89410	K374-27	85001	89410
60657-003	85072		671654	85936	89456	B71-1003	83312	89409	K374-28	85314	89425
60665-011	85967		671656	85985		B71-6000	85920		K374-28PLUS	85314	89425
60665-013	85965		671699	85937		B71-6002	85012	89413	K374-29	85310	89423
60665-015	85966		671794	85067	89451	B71-6003	85029		K374-29PLUS	85310	89423
60670-005	83121		671962	85936	89456	B71-6004	85084	89460	K374-3	83312	89409
60670-005PLUS	83121		671962PLUS	85936	89456	B71-6005	85084	89460	K374-3-1	83312	89409
60670-008	83123	89405	671963	85937		B71-6006	85084	89460	K374-32	85310	89423
60670-008PLUS	83123	89405	675041	83353		B71-6007	85062	89408	K374-33	83312	89409
60680-004	83143		675122	85001	89410	B71-6008	83312	89409	K374-33PLUS	83312	89409
60680-005	83142		680237	85303	89422	B71-6010	85023	89415	K374-36		89432
665092	83312	89409	680239	85310	89423	B71-6011	85062	89408	K374-4	85314	89425
665118	83312	89409	680240	85302	89420	B71-6012	85119		K374-5	83312	89409
665174	85060		680241	85311	89424	B71-6013	85012	89413	K374-7	85310	89423
665331	83353		680242	85308	89422	B71-6015	85012	89413	K374-9	85310	89423
665453	85001	89410	680253	85314	89425	B71-6016	85012	89413	K374-C31	83312	89409
665565	85007	89412	680261	85062	89408	B71-6017	85910		K374-C7	85310	89423
665565PLUS	85007	89412	680279	83209	89414	B71-6018	85012	89413	R71-6006	83063	
665617	85031		680280	85906	89407	B71-6019	85989		R71-6007	83008	
665632	85013	89414	680281	85003	89411	B71-6020	85989		R71-6008	83035	
665633	85033	89427	680283	83353		C71-1002	85067	89451	S-20126	85323	89436
665670	85001	89410	680303	85007	89412	C71-1002PLUS	85067	89451	TK19679	83126	89440
665680	83312	89409	680425	85320	89429	C71-1011	85069	89455			
665783	83123	89405	680435	85033	89427	C71-1011PLUS	85069	89455			

### KENWORTH AMORTIGUADORES DE CABINA

# E.O.	Fleetline	GasSLX	# E.O.	Fleetline	GasSLX	# E.O.	Fleetline	GasSLX	# E.O.	Fleetline	GasSLX
1201-0012	83023		1202-0044	83025		1202K046	83049		R71-1004	83049	
1201-1043	83025		1202-0054	83021		1202K064	83024		R71-1005	83024	
1201-1044	83025		1202-1043	83025		1202K065	83002		R71-6005	83042	
1201-1046	83049		1202-1046	83049		1202K164	83031		T71-1000	83031	
1202-0012	83023		1202-1064	83024		1202K264	83031		T71-1001	83031	
1202-0022	83046		1202-1065	83002		1202K286	83056		T71-1002	83002	
1202-0032	83016		1202-1164	83031		96027-10545	83011		T71-1003	83056	
1202-0042	83025		1202-1264	83031		PP1058870	83059				
1202-0043	83032		1202-1286	83056		PP2582870	83012				

### KIMBLE MIXER CO

# E.O.	Fleetline	GasSLX	# E.O.	Fleetline	GasSLX	# E.O.	Fleetline	GasSLX	# E.O.	Fleetline	GasSLX
OE10455	646155										

**Nota Importante:** Los intercambios deben utilizarse para cuestiones de almacenamiento únicamente. Cuando se identifiquen varios intercambios, consulte la sección de aplicaciones de este catálogo.

## Lista de Intercambios contra Competidores y Equipo Original

### KING OF THE ROAD

# E.O.	Fleetline	GasSLX	# E.O.	Fleetline	GasSLX	# E.O.	Fleetline	GasSLX	# E.O.	Fleetline	GasSLX
141700131809	85029		16-16736-000	85029		16-16873-000	85029		16-18103-000	85900	
141700131810	83160		16-16737-000	83160		16-16874-000	83160		481700000493	85900	

### KONI

Koni	Fleetline	GasSLX	Koni	Fleetline	GasSLX	Koni	Fleetline	GasSLX	Koni	Fleetline	GasSLX
090-2209-SP2	85001	89410	8240-1148	G63720		90-1409-SP1	85722		90-2326	85970	
30-1348	G63424		84-1168	83130		90-1466	85707		90-2327	85341	
30-1350	G63511		88-1385	83105		90-1577-SP1	85310	89423	90-2368	86203	
30-1351	G63490		88-1417	83312	89409	90-1608	83104		90-2368 SP1	86203	
30-1365	G63611		88-1419	83136		90-1811	85301		90-2368 SP2	86203	
30-1366	G63610		88-1422	85030	89440	90-1813-SP1	85712		90-2404	86203	
30-1381	G63426		88-1457-SP1	83209	89414	90-1813-SP3	85968		90-2407	85709	
30-1421	G63547		88-1458-SP1	83122	89406	90-1862	85708		90-2416	86202	
30-1422	G63548		88-1458-SP2	83122	89406	90-1867	85053	89442	90-2416 SP1	86202	
30-1456	G63782		88-1468	83209	89414	90-1868	85307		90-2433	85710	
30-1457	G63781		88-1476	83353		90-1868-SP1	85307		90-2434	85702	
30-1501	G63608		88-1489	85036	89405	90-1896	85302	89420	90-2477	85900	
30-1502	G63679		88-1490	83124	89407	90-1897	85303	89422	90-2478	85902	
30-1565	G63707		88-1499	85001	89410	90-1898	83215		90-2497SP1	85712	
30-1566	G63708		88-1509	85027	89418	90-1907-SP1	85300	89419	90-2529	85707	
30-1606	G63423		88-1510	85708		90-1908-SP1	85723		90-2530	85707	
30-1607	G63422		88-1517	85040		90-1910	85704		90-2563	85006	
30-1614	G63678		88-1518	85040		90-1912	85318		90-2572	85329	
30-1624	G63424		88-1520	85040		90-1922	85900		90-2573	85329	
30-1627	G63690		88-1525	85040		90-1943	85307		90-2574	85330	
30-1630	G63425		88-1532	85708		90-1951-SP1	85734		90-2575	85700	
30-1630	G63722		88-1540	85051		90-1951-SP5	85712		90-2576	85700	
80-2516	G63421		88-1541	85045		90-1965	85304		90-2586	85728	
80-2517	G63422		88-1558	85013	89414	90-1968	85720		90-2587	85729	
80-2633	G63423		88-1559-SP1	85036	89405	90-1974	85311	89424	90-2588	85339	
80-2634	G63422		88-1560	85062	89408	90-2059	85722		90-2589	85727	
82-1952	G63347		88-1561	85012	89413	90-2060	85722		90-2610-SP1	87017	
82-1954	G63355		88-1562	85003	89411	90-2102-SP1	85708		90-2627	89461	
82-1955	G63349		88-1616	85014		90-2148	85304		90-5055-SP2	85318	
82-1969	G63500		88-1639	83130		90-2164-SP1	85723		90-5180	85300	89419
82-1970	G63350		88-1641	85029		90-2209	85308	89422	9020-1042	85708	
82-2158	G63357		88-1642	83124	89407	90-2251	85717		90F-1235	85700	
82-2246	G63299		88-1644	85000	89436	90-2252	85714		91-2368	86203	
82-2345	G63413		88-1646	83613		90-2253-SP2	85718		91-2400	86203	
82-2372	G63609		88-1647	83317		90-2254	85720		91-2527	86202	
82-2384	G63488		88-5162	83209	89414	90-2255	85719		92-1227	85722	
8240-1029	G63386		88-5163	83122	89406	90-2256	85718				
8240-1054	G63375		8805-1022	85724	89443	90-2257	85716				
8240-1055	G63454		90-1400	83104		90-2325	85340				

### KWK-LOC (JIFFLOX)

# E.O.	Fleetline	GasSLX	# E.O.	Fleetline	GasSLX	# E.O.	Fleetline	GasSLX	# E.O.	Fleetline	GasSLX
CP-5222	85315										

### KYB

Kyb	Fleetline	GasSLX	Kyb	Fleetline	GasSLX	Kyb	Fleetline	GasSLX	Kyb	Fleetline	GasSLX
340043	G63909		341617	85005	89430	341626	85000	89436	343127	G63900	
341302	G63678		341618	85918	89449	341627	85006		343160	G63914	
341312	G63865		341619	83136		341628	85724	89443	343209	G63903	
341339	G63918		341620	85033	89427	341629	85938		343210	G63799	
341343	G63893		341621	85311	89424	341630	85052		343272	G63860	
341374	G63884		341622	85023	89415	341631	646155				
341613	85062	89408	341623	85003	89411	341632	83124	89407			
341614	85001	89410	341624	85036	89405	341633	83215				
341615	83215		341625	85000	89436	343030	G63949				

**Nota Importante:** Los intercambios deben utilizarse para cuestiones de almacenamiento únicamente. Cuando se identifiquen varios intercambios, consulte la sección de aplicaciones de este catálogo.

## Lista de Intercambios contra Competidores y Equipo Original

### KYB... cont

Kyb	Fleetline	GasSLX	Kyb	Fleetline	GasSLX	Kyb	Fleetline	GasSLX	Kyb	Fleetline	GasSLX
343353	G63880		344273	G63638		345602	85052		KG54330	G63809	
343379	G63845		344291	G63873		345604	85051		KG54331	G63837	
343388	G63712		344299	G63710		345605	85012	89413	KG54333	G63810	
343395	G63842		344338	G63776		345606	83136		KG54335	G63815	
343395	G64014		344341	G63847		345607	83130		KG5438	G63492	
343403	G63660		344342	G63829		345608	85060		KG5440	G63350	
344040	G63421		344353	G63877		345609	G63616		KG5442	G63626	
344041	G63422		344356	G63862		345611	83120		KG5444	G63904	
344042	G63423		344359	G63720		345613	85005	89430	KG5446	G63909	
344043	G63813		344364	G63673		345614	83309	89446	KG5447	G63491	
344044	G63907		344365	G63662		345615	83314		KG5455	G63456	
344045	G63492		344366	G63366		345616	83125		KG5456	G63416	
344046	G63491		344367	G63714		345617	83203	89436	KG5462	G63494	
344047	G63950		344368	G63716		345618	83126	89430	KG5466	G63492	
344049	G63414		344369	G63624		345620	83456	89447	KG5474	G63479	
344050	G63773		344370	G63622		345621	85003	89411	KG5475	G63432	
344051	G63420		344371	G63623		349004	G63886		KG5476	G63611	
344054	G63444		344372	G63661		349009	G63897		KG5477	G63906	
344055	G63484		344373	G63675		349009	G63919		KG5478	G63489	
344066	G63359		344374	G63778		349010	G64006		KG5479	G63488	
344067	G63347		344375	G63715		349119	89439		KG5480	G63609	
344068	G63355		344377	G63717		441600	85310	89423	KG5482	G63675	
344069	G63500		344380	G63783		441601	85710		KG5484	G63635	
344072	G63349		344381	G63803		441602	85724	89443	KG5485	G63639	
344074	G63811		344382	G63887		444058	83508		KG5487	G63525	
344075	G63413		344385	G63866		444328	85055		KG5488	G63403	
344076	G63410		344387	G63617		444329	83509		KG5489	G63614	
344077	G63406		344397	G63772		553360	G63937		KG5491	G63604	
344078	G63683		344398	G63958		553361	G63689		KG5494	G63620	
344079	G63775		344399	G63848		554347	G63886		KG5495	G63929	
344080	G63426		344401	G63970		KG4159	G63892		KG5496	G63624	
344081	G63375		344402	G63817		KG4160	G64016		KG5497	G63622	
344082	G63454		344404	G63844		KG4613A	G63909		KG5498	G63623	
344083	G63457		344410	G63885		KG4616	G63798		KG5499	G63621	
344084	G63490		344419	G63888		KG5194	G64000		KG5534	G63610	
344085	G63306		344426	G63299		KG5196	G64013		KG5538	G63484	
344086	G63353		344427	G63904		KG5198A	G63606		KG5555	G63914	
344088	G63424		344428	G63494		KG5401	G63299		KG6001A	83304	
344089	G63425		344430	G63611		KG5406	G63386		KG6002A	85030	89440
344090	G63492		344431	G63620		KG5417	G63371		KG6003	83309	89416
344091	G63511		344435	G63721		KG5420	G63366		KG6004	85320	89429
344092	G63490		344438	G63869		KG5421	G63387		KG6005	83216	
344093	G63905		344464	G63882		KG5422	G63183		KG6006	85012	89413
344094	G63915		344466	G63879		KG5424	G63187		KG6007	85007	89412
344095	G63499		344481	G63894		KG5426	G63396		KG6008A	83122	89406
344096	G63460		344496	G64012		KG5429	G63398		KG6009A	83303	
344098	G63612		345005	G63694		KG54300	G63615		KG6010	83308	89435
344202	G63479		345022	G63832		KG54301	G63616		KG6198	G63616	
344263	G63488		345023	G63828		KG54302	G63782		KG6199	85012	89413
344264	G63387		345024	G63864		KG54303	G63781		KG6201	83456	89447
344265	G63489		345030	83304		KG54304	G63707		KG6403	G63605	
344266	G63818		345030	G63394		KG54305	G63640		KG6406	G63183	
344267	G63455		345042	G63883		KG54307	G63812		KG6412	G63625	
344268	G63614		345043	G63878		KG54308	G63708		KG6415	85013	89414
344269	G63679		345055	G63872		KG5431	G63511		KG6416	83123	89405
344272	G63386		345601	83613		KG54317	G63726				

**Nota Importante:** Los intercambios deben utilizarse para cuestiones de almacenamiento únicamente. Cuando se identifiquen varios intercambios, consulte la sección de aplicaciones de este catálogo.

# Lista de Intercambios contra Competidores y Equipo Original

## LINK MANUFACTURING AMORTIGUADORES DE CABINA

# E.O.	Fleetline	GasSLX	# E.O.	Fleetline	GasSLX	# E.O.	Fleetline	GasSLX	# E.O.	Fleetline	GasSLX
1201-0012	83023		1201-9011	83053		1202-1046	83049		654799	83025	
1201-0154	83051		1201-9013	83062		1202-1064	83024		654811	83024	
1201-0254	83051		1201-9014	83062		1202-1065	83002		654833	83021	
1201-1043	83025		1201-9018	83062		1202-1164	83031		654847	83002	
1201-1044	83025		1201-9021	83062		1202-1212	83013		654849	83031	
1201-1046	83049		1202-0012	83023		1202-1213	83005		654867	83025	
1201-1049	83025		1202-0022	83046		1202-1286	83056		LG40450	83016	
1201-1212	83013		1202-0032	83016		1202K065	83002		LG40470	83016	
1201-1213	83005		1202-0042	83025		1202K164	83031		R71-1004	83049	
1201-9001	83052		1202-0043	83032		1202K264	83031		R71-1005	83024	
1201-9002	83052		1202-0044	83025		1202K286	83056		T71-1000	83031	
1201-9003	83052		1202-0052	83021		1202P055	83061		T71-1001	83031	
1201-9007	83054		1202-0054	83021		632120	83046		T71-1002	83002	
1201-9008	83054		1202-1042	83025		632129	83023				
1201-9009	83054		1202-1043	83025		635705	83016				
1201-9010	83053		1202-1044	83025		654669	83021				

## LINK MANUFACTURING LTD.

# E.O.	Fleetline	GasSLX	# E.O.	Fleetline	GasSLX	# E.O.	Fleetline	GasSLX	# E.O.	Fleetline	GasSLX
1210-0005	85734		1210-0528	85904		671093	85904				

## LINK/HIGH-STEER

# E.O.	Fleetline	GasSLX	# E.O.	Fleetline	GasSLX	# E.O.	Fleetline	GasSLX	# E.O.	Fleetline	GasSLX
1210-0001	646155		1210-0007	665937		1210-0010	646155		632155	646177	
1210-0002	632147		1210-0009	665937		1210-0012	646155		646168	646155	

## LODAL, INC.

# E.O.	Fleetline	GasSLX	# E.O.	Fleetline	GasSLX	# E.O.	Fleetline	GasSLX	# E.O.	Fleetline	GasSLX
9960257	83122	89406									

## LONDON MIXER

# E.O.	Fleetline	GasSLX	# E.O.	Fleetline	GasSLX	# E.O.	Fleetline	GasSLX	# E.O.	Fleetline	GasSLX
MB-37737-30	646155										

## M.A.N.

# E.O.	Fleetline	GasSLX	# E.O.	Fleetline	GasSLX	# E.O.	Fleetline	GasSLX	# E.O.	Fleetline	GasSLX
134	85709		81-43701-6537	85709		81-43701-6572	85708		81-43702-6089	85982	
25-1700-106-654	85708		81-43701-6538	85708		81-43701-6573	85722		9020M-1042	85709	
471700007680	85110		81-43701-6539	85708		81-43701-6609	85709				
481700004476	85982		81-43701-6543	85708		81-43701-6924	85110				

## MACK

# E.O.	Fleetline	GasSLX	# E.O.	Fleetline	GasSLX	# E.O.	Fleetline	GasSLX	# E.O.	Fleetline	GasSLX
141700000373	85061	89450	14QK-2100P6	85036	89405	14QK-2133M	85001	89410	14QK-3116M	83101	
141700000380	85061	89450	14QK-2100P7	83221		14QK-2133M2	85001	89410	14QK-366	85036	89405
141700005839	85098		14QK-2100P8	83242		14QK-2136M	85061	89450	14QK-366P1	85036	89405
14QK-1200P4	83207	89407	14QK-2102	85304		14QK-282P1	83216		14QK-366P2	85036	89405
14QK-140	85304		14QK-2105	83209	89414	14QK-282P3	83216		14QK-366P3	85036	89405
14QK-140P1	83225		14QK-2107	83215		14QK-288-P1	85007	89412	14QK-366P4	83209	89414
14QK-142	85305		14QK-2107P1	83215		14QK-288P2	83217		14QK-372M	83221	
14QK-142AP1	83215		14QK-2107P2	83215		14QK-29001P2	85303	89422	14QK-372M2	83209	89414
14QK-142P1	83215		14QK-2107P3	83215		14QK-29301P1	83207	89407	14QK-372M3	83122	89406
14QK-143	83207	89407	14QK-2108	83203	89436	14QK-29301P2	83207	89407	14QK-373	83215	
14QK-145	85307		14QK-2108P1	83203	89436	14QK-29302	83207	89407	14QK-375M	83123	89405
14QK-20001P2	85308	89422	14QK-2110	85305		14QK-29302P1	83207	89407	14QK-377M	83215	
14QK-2100	83221		14QK-2110P1	85305		14QK-3100	85739		14QK-378	83215	
14QK-2100D-P4	83207	89407	14QK-2113	85001	89410	14QK-3101M	85066	89448	14QK-378M	83215	
14QK-2100P1	83221		14QK-2113P3	85001	89410	14QK-3107M	85061	89450	14QK-390	83105	
14QK-2100P2	83209	89414	14QK-2113P4	85007	89412	14QK-3108	85080		14QK-392AM	85005	89430
14QK-2100P3	83207	89407	14QK-2113P5	85001	89410	14QK-3108M	85080		14QK-392AM2	83123	89405
14QK-2100P4	83207	89407	14QK-2113P6	85007	89412	14QK-3114M	85061	89450	14QK-392AM3	85005	89430
14QK-2100P5	83221		14QK-2115	85305		14QK-3115M	85972		14QK-392BM	85005	89430

**Nota Importante:** Los intercambios deben utilizarse para cuestiones de almacenamiento únicamente. Cuando se identifiquen varios intercambios, consulte la sección de aplicaciones de este catálogo.

## Lista de Intercambios contra Competidores y Equipo Original

### MACK... cont

# E.O.	Fleetline	GasSLX	# E.O.	Fleetline	GasSLX	# E.O.	Fleetline	GasSLX	# E.O.	Fleetline	GasSLX
14QK-392BM2	85321		14QK-493M	83101		25625187	83209	89414	60657-007	85072	
14QK-392BM3	85005	89430	20485633	85933	89454	25625223	83111		60670-006	83147	
14QK-392M	85005	89430	20513881	85061	89450	25625234	83125		64838-002	85933	89454
14QK-393AM	83123	89405	20570098	83147		25625254	83125		650102	85001	89410
14QK-393M	85010		20625775	85014		25625743	85005	89430	650107	85316	89426
14QK-396	85005	89430	20863239	85080		25626048	85080		650107MT	85316	89426
14QK-396M	85005	89430	20897198	85061	89450	25626149	85080		650400MT	85033	89427
14QK-410M	83125		20973993	85061	89450	25632145	85001	89410	650402	85311	89424
14QK-410M2	83137		20998401	85014		25632147	85305		650402MT	85311	89424
14QK-410M3	83125		21002497	85972		25633154	85906	89407	650404	85310	89423
14QK-413M	83111		21010744	83101		4103-5000447861	83105		650404MT	85310	89423
14QK-413M4	83110		21155033	83101		4103-5000546892	83105		650405	85023	89415
14QK-413M5	83138		21436096	85098		446-51-211	85739		650405MT	85023	89415
14QK-413M6	83111		21462382	85088		471700000431	85066	89448	650406	85024	89416
14QK-413M7	83111		21687170	85120		471700000445	85080		650408	85319	89428
14QK-414M	85906	89407	25621571	83215		471700000451	85080		650408MT	85319	89428
14QK-414M2	85909		25621955	85001	89410	471700002626	85061	89450	651012	83221	
14QK-415M	83112		25622221	83111		471700002861	85014		651103	85036	89405
14QK-415M7	83112		25622345	83242		471700006039	85088		651151	83209	89414
14QK-421M	85014		25622466	85001	89410	471700131921	85933	89454	70042	85302	89420
14QK-422M	85933	89454	25623321	83215		47902-25	83125		8083872	85978	
14QK-423M	85978		25624241	83112		47902-9	83123	89405	SDA141700000380	85061	89450
14QK-424M	83147		25624341	83110		4940654	83216		SDA471700000431	85066	89448
14QK-427M	85080		25624351	85909		5533699	85302	89420	SDA471700002861	85014	
14QK-428	85080		25624365	83217		5554184	85302	89420	V10234121	83105	
14QK-428M	85080		25624837	85909		57241-004	83110		V10242320	83105	
14QK-431M	85061	89450	25625091	83215		57241-006	83111				
14QK-434M	85014		25625151	85036	89405	5966-90044025	83209	89414			

### MACK AMORTIGUADORES DE CABINA

# E.O.	Fleetline	GasSLX	# E.O.	Fleetline	GasSLX	# E.O.	Fleetline	GasSLX	# E.O.	Fleetline	GasSLX
1201-0012	83023		14QK-376	83003		14QK-399M3	83045		21345869	83066	
1202-0012	83023		14QK-382	83018		14QK-411	83007		21490486	83066	
1202-0022	83046		14QK-382-P2	83018		14QK-411AM	83007		25622612	83041	
1202-0032	83016		14QK-391AM	83041		14QK-411M	83007		25622613	83041	
14QK-2111	83019		14QK-391AM2	83041		14QK-432M	83050		25625635	83045	
14QK-2111-P2	83019		14QK-391BM	83041		14QK-439M	83050		25625636	83045	
14QK-2111-P4	83019		14QK-391BM2	83041		14QK-440M	83058		25625637	83045	
14QK-29303-P2	83014		14QK-391M	83041		20873442	83050		25631922	83007	
14QK-303M	83050		14QK-391M2	83041		20874147	83050				
14QK-3103M	83050		14QK-399M	83045		21154393	83050				
14QK-374	83003		14QK-399M2	83045		21154397	83058				

### MAECO

# E.O.	Fleetline	GasSLX	# E.O.	Fleetline	GasSLX	# E.O.	Fleetline	GasSLX	# E.O.	Fleetline	GasSLX
1085	83214		16774	83215		70021	85303	89422	70312	85001	89410
12608	83125		16775	83207	89407	70029	85308	89422	70315	85063	
12788	83216		16776	83202		70034	85302	89420	70317		89432
12866	83207	89407	16777	85006		70039	85303	89422	70331	85314	89425
16385	83215		16778	83203		70041	85305		70332	83314	
1668722	85030	89440	16779	83126	89440	70042	85302	89420	70334	85316	89426
16720	83107		16780	83123	89405	70088	85307		70397	85006	
16767	85013		16781	85006		70123	85716		70402	85305	
16768	83217		16787	85030	89440	70127	85006	89401	70642	85300	
16769	83221		16949	83120		70128	85006	89401	70644	85334	
16770	83209		16950	83118		70162	85716				
16771	83126	89430	6025	83122	89406	70163	85302	89420			
16772	83122	89406	6026	83204		70164	85716				
16773	85005		70018	85303	89422	70300	85320	89429			

**Nota importante:** Los intercambios deben utilizarse para cuestiones de almacenamiento únicamente. Cuando se identifiquen varios intercambios, consulte la sección de aplicaciones de este catálogo.

## Lista de Intercambios contra Competidores y Equipo Original

### MAECO... cont

# E.O.	Fleetline	GasSLX	# E.O.	Fleetline	GasSLX	# E.O.	Fleetline	GasSLX	# E.O.	Fleetline	GasSLX
70646	85313		70651	85013	89414	70720	85934		OE10882	85740	
70647	85701		70652	85030	89440	70721	83125		OE10883	85339	
70648	89414		70663	85013	89414	74039	85303	89422	OE12425	83214	
70650	89440		70691	85007		OE10881	85711		SC-2920	83176	

### MANDALAY COACH

# E.O.	Fleetline	GasSLX	# E.O.	Fleetline	GasSLX	# E.O.	Fleetline	GasSLX	# E.O.	Fleetline	GasSLX
141700131809	85029		16-16736-000	85029		16-16873-000	85029		16-18103-000	85900	
141700131810	83160		16-16737-000	83160		16-16874-000	83160		481700000493	85900	

### MARMON

# E.O.	Fleetline	GasSLX	# E.O.	Fleetline	GasSLX	# E.O.	Fleetline	GasSLX	# E.O.	Fleetline	GasSLX
1-7001	83216		51-139-28	85003	89411	576451	83122	89406			
37-1-1	83122	89406	51-163-7	83123	89405	665147	83216				

### MARMON AMORTIGUADORES DE CABINA

# E.O.	Fleetline	GasSLX	# E.O.	Fleetline	GasSLX	# E.O.	Fleetline	GasSLX	# E.O.	Fleetline	GasSLX
1202-0022	83046		1202-0054	83021							

### MATSON SCHOOL BUS

# E.O.	Fleetline	GasSLX	# E.O.	Fleetline	GasSLX	# E.O.	Fleetline	GasSLX	# E.O.	Fleetline	GasSLX
5392387	85303	89422									

### MC NEILUS TRUCK & MAN.

# E.O.	Fleetline	GasSLX	# E.O.	Fleetline	GasSLX	# E.O.	Fleetline	GasSLX	# E.O.	Fleetline	GasSLX
1139039 MTM	85334		1398980 MTM	83127		2034140 MTM	646155		64442AX MTM	83128	
1139046 MTM	83112		1404068 MTM	85087		217330	85303		6HA961 MTM	83123	89405
1139059 MTM	83207	89407	1404068 MTM	85980		2218640 MTM	83009		6HB390 MTM	83137	
1139069 MTM	83209	89414	1410046 MTM	85919		3215395 MTM	83112		6HD720 MTM	85909	
1170719	632147		1411765 MTM	83148		3HR582 MTM	85013	89414	6HS773 MTM	83122	89406
12405FX1 MTM	85303	89422	1412744 MTM	85966		3HR916 MTM	83207	89407	6KP857 MTM	85000	89436
1323106 MTM	85305		1429317 MTM	85919		4HA569 MTM	85932	89453	7HS237 MTM	83122	89406
1333575 MTM	85072		1431085 MTM	85738		4KP398 MTM	85933	89454	7HS237 MTM	83149	
1340975 MTM	83142		1432386 MTM	85965		5HA994 MTM	85916		7HS534 MTM	85906	89407
1340976 MTM	85919		1433009 MTM	85962		5HB645 MTM	83109		8KK524 MTM	83168	
1340979 MTM	83143		1468783 MTM	85345		5KK247 MTM	85977		9HB362 MTM	85976	
1360386 MTM	85323	89436	1485576 MTM	85979		600-115994B	632147		9KK464 MTM	85079	
1367383 MTM	83147		1491909 MTM	83128	89436	600-11599M	632147				
1396513 MTM	85959		1KK552 MTM	85967		600-188206	646155				

### MERCEDES BENZ

# E.O.	Fleetline	GasSLX	# E.O.	Fleetline	GasSLX	# E.O.	Fleetline	GasSLX	# E.O.	Fleetline	GasSLX
16-16781-000	85108		3643267200	83173		A3263260000	85117		CL12657-5521	85093	
16-16782-000	85096		3683230100	85981		A3563260700	85117		L-12657	83173	
16-16868-000	85095		3843230500	85981		A3843230300	85981		ZGS002-001	85981	
344-323-75	83100		45280-6918	85973		A3843260200	83172		ZGS004-001	85981	
364 323 72 00	85093		471700004270	85117		A6293220000	85993		ZGS006-001	83172	
364 323 74 00	85324		481700004271	85993		A6293230100	85993				

### MERITOR

# E.O.	Fleetline	GasSLX	# E.O.	Fleetline	GasSLX	# E.O.	Fleetline	GasSLX	# E.O.	Fleetline	GasSLX
14QK-3100	85739		446-51-211	85739		671507	87015		A-7805F-1020	86200	
202447	85919		671020	87015		671907	85919		A-7805L-1000	85919	
21224745	86203		671500	86201		680705	85737		A-7805L-1026	87015	
21224778	86202		671502	86202		700115	85712		A-7805P-1030	85737	
21227751	87015		671503	86203		7805-F-1020	86200				
21228392	86201		671506	86200		A-3280-M-9711	85919				

### MILITARY

# E.O.	Fleetline	GasSLX	# E.O.	Fleetline	GasSLX	# E.O.	Fleetline	GasSLX	# E.O.	Fleetline	GasSLX
680781	85308		7409617	85308							

### MITSUBISHI-FUSO

# E.O.	Fleetline	GasSLX	# E.O.	Fleetline	GasSLX	# E.O.	Fleetline	GasSLX	# E.O.	Fleetline	GasSLX
MB161497	G63299		MC809390	83103							
MC114595	G63405		MC813135	83456	89447						

**Nota Importante:** Los intercambios deben utilizarse para cuestiones de almacenamiento únicamente. Cuando se identifiquen varios intercambios, consulte la sección de aplicaciones de este catálogo.

## Lista de Intercambios contra Competidores y Equipo Original

### MITSUBISHI-FUSO... cont

# E.O.	Fleetline	GasSLX	# E.O.	Fleetline	GasSLX	# E.O.	Fleetline	GasSLX	# E.O.	Fleetline	GasSLX
MC813511	G63398		MC814614	85009		MC826268	G63610				

### MOHAWK

# E.O.	Fleetline	GasSLX	# E.O.	Fleetline	GasSLX	# E.O.	Fleetline	GasSLX	# E.O.	Fleetline	GasSLX
01-0100-905	85303	89422	10234504	85717		6-367-7	85305		97-2201-00007	85703	
020273544	83203	89436	1235233	85736		680323	85700		97-2201-00011	85704	
050134508	85718		22012079	85701		680332	85701		97-9999-02320	85704	
10134504	85715		22012082	85702		680485	85733		MM-6886	83207	89407
10134506	85714		22012114	85700		695195	85707		MM-6957	83225	
10234503	85714		4968853	83216		695196	85707		MM-74029	85308	89422

### MONROE

Monroe	Fleetline	GasSLX	Monroe	Fleetline	GasSLX	Monroe	Fleetline	GasSLX	Monroe	Fleetline	GasSLX
12872	83219		34760	G63622		34960	G63366		37064	G63454	
16385	83215		34761	G63623		34963	G63406		37065	G63426	
16721	83125		34762	G63638		34964	G63456		37066	G63915	
171322	G63679		34763	G63897		34972	G63610		37067	G63460	
171341	G64014		34768	83209	89414	34975	G63511		37068	G63905	
31029	G63798		34776	G63661		34983	G63489		37069	G63499	
32066	G63900		34777	G63662		37011	G63414		37070	G63799	
32207	G63949		34778	G63673		37012	G63603		37071	G63914	
32217	G63612		34782	G63674		37013	G63525		37072	G63903	
32273	G63782		34787	G63615		37014	G63524		37073	G63907	
32274	G63781		34788	G63616		37015	G63614		37074	G63620	
32314	G63604		34791	G63692		37016	G63635		37075	G63606	
32341	G63675		34794	G63360		37017	G63639		37076	G63639	
32392	G63848		34796	G63929		37021	G63422		37077	G63909	
33049	G63610		34797	G63406		37022	G63495		37080	G63624	
34504	G63817		34798	G63609		37024	G63610		37082	G63626	
34514	G63958		34799	G63609		37026	G63424		37085	G63896	
34515	G63675		34802	83216		37027	G63425		37086	G63897	
34516	G63848		34803	G63306		37028	G63904		37088	G63500	
34518	G63809		34817	G63355		37029	G63928		37089	G63350	
34519	G63837		34821	G63406		37030	G63547		37090	G63357	
34523	G63969		34822	G63371		37031	G63404		37091	G63413	
34524	77968		34824	G63349		37032	G63494		37093	G63359	
34612	83017		34828	G63510		37033	G63548		37094	G63353	
34617	83019		34831	G63359		37035	G63607		37097	G63950	
34656	G63778		34839	G63671		37036	G63410		37099	G63423	
34657	G63716		34895	83207	89407	37038	G63461		37100	G63904	
34658	G63715		34899	G63500		37040	G63347		37101	G63660	
34675	G63783		34900	G63386		37041	G63349		37102	G63661	
34676	G63662		34901	G63387		37042	G63906		37103	G63662	
34677	G63803		34904	G63299		37044	G63488		37104	G63673	
34684	G63622		34905	G63405		37045	G63183		37108	G63707	
34685	G63808		34906	G63396		37046	G63389		37109	G63708	
34686	G63809		34907	G63511		37047	G63902		37110	G63676	
34687	G63810		34909	G63187		37048	G63492		37111	G63937	
34690	G63675		34911	G63350		37049	G63355		37112	G63689	
34721	83103		34912	83304		37050	G63489		37113	G64005	
34722	83400		34919	G63411		37051	G63490		37114	G64004	
34730	G63386		34920	G63675		37052	G63406		37120	G63511	
34733	G63617		34927	G63409		37053	G63386		37121	G63490	
34736	G63394		34928	G63416		37055	G63455		37122	G63678	
34741	G63489		34929	G63403		37058	G63457		37123	G63690	
34751	G63607		34930	G63811		37060	G63621				
34755	G63812		34954	G63484		37061	G63502				
34756	G63488		34958	G63377		37062	G63818				
34759	G63624		34959	G63432		37063	G63375				

**Nota Importante:** Los intercambios deben utilizarse para cuestiones de almacenamiento únicamente. Cuando se identifiquen varios intercambios, consulte la sección de aplicaciones de este catálogo.



## Lista de Intercambios contra Competidores y Equipo Original

### MONROE... cont

Monroe	Fleetline	GasSLX	Monroe	Fleetline	GasSLX	Monroe	Fleetline	GasSLX	Monroe	Fleetline	GasSLX
37128	G63929		551001	83125		65102	85001	89410	65174	58942	
37129	G63421		551002	83122	89406	65103	85320	89429	65175	85084	89460
37130	G63609		553001	79900		65104	85026	89417	65176	85084	89460
37131	G63714		553002	G56778		65105	85026	89417	65177	85012	89413
37132	G63778		555004	G63299		65106	85091		65178	85998	
37133	G63716		555005	G63689		65107	85316	89426	65179	85995	
37134	G63715		555006	G63173		65108	85030	89432	65400	85033	89427
37135	G63722		555010	77623		65109	85058	89431	65401	85013	89414
37144	G63717		555011	83119		65110	85005	89430	65402	85311	89424
37149	G63783		555012	G63183		65111	85006		65404	85310	89423
37151	G63803		555019	85069	89455	65112	89402		65405	85023	89415
37153	G63772		555026	83124	89407	65113	85012	89413	65406	85024	89416
37155	G63676		555027	83124	89407	65114	85036	89405	65407	85736	
37156	G63869		555028	83207	89407	65115	85027	89418	65408	85319	89428
37157	G63726		555029	83144		65116	85329		65409	85003	89411
37158	G63712		555031	83177		65118	85001	89410	65410	85300	89419
37160	G63710		555032	83178		65119	85029		65411	85036	89405
37161	G63847		555033	G63386		65120	85010		65412	83122	89406
37162	G63829		555034	G63387		65121	85971		65413	83136	
37163	G63817		555035	G63357		65122	85063		65414	85324	
37164	G63675		555036	77403		65123	85054	89438	65415	85046	89434
37166	G63866		555037	G63359		65124	85053	89442	65416	85000	89436
37191	G63506		555038	G63413		65128	85031		65417	85322	
37198	G63694		555039	G63359		65129	85701		65418	85906	89407
37199	G63860		555041	G63866		65130	85061	89450	65419	85000	89436
37202	G64002		555043	83400		65133	85935		65420	85013	89414
37203	G63844		555045	G63394		65139	85918	89449	65421	85916	
37204	G63845		557001	85013	89414	65140	85918	89449	65422	85912	
37206	G63958		557002	85097		65141	85091		65423	85907	
37217	G63862		557004	G63866		65142	83131		65424	85905	
37218	G63877		557005	83136		65143	83163		65425	89441	
37231	G63720		557006	83136		65144	85928		65426	85054	89438
37238	G63815		557007	85099		65145	85957		65427	85903	
37240	G63865		557008	85029		65146	85925		65428	85321	
37241	G63842		557009	85007	89412	65147	85924	89457	65429	85030	89440
37242	G64014		557010	83144		65148	85918	89449	65430	85968	
37243	G63610		557011	83160		65150	85953		65431	85909	
37244	G63864		557012	85029		65151	85953		65432	85910	
37246	G64003		557013	83127		65153	85921		65433	85910	
37249	G63434		557014	83126	89430	65155	85928		65434	85012	89413
37803	G63306		557015	83209	89414	65156	85928		65435	85901	
38072	83043		557017	85029		65157	85954		65436	85900	
39052	G63868		557018	83127		65158	85954		65439	85716	
40209	83161		557020	83123	89405	65159	85070	89459	65440	85711	
54487	85073		557021	85051		65160	85080		65441	85704	
54488	85074		557022	85051		65161	83136		65442	85700	
550010	G63375		557023	83144		65162	85959		65443	85706	
550011	69606		557026	83127		65163	85954		65444	85311	89424
550012	G63375		557027	83144		65166	85090		65445	85731	
550013	69724		557028	85010		65167	G63969		65446	85730	
550016	G63424		557031	85010		65168	77968		65447	85703	
550017	G63425		557033	85900		65169	85342		65448	85700	
550018	69575		557039	85959		65170	85969		65449	85702	
550019	G63918		557040	85092		65171	85964		65451	85029	
550020	G63919		5777	G63880		65172	83153		65452	85733	
550051	43140		65101	85062	89408	65173	85336		65453	85904	

**Nota Importante:** Los intercambios deben utilizarse para cuestiones de almacenamiento únicamente. Cuando se identifiquen varios intercambios, consulte la sección de aplicaciones de este catálogo.

## Lista de Intercambios contra Competidores y Equipo Original

### MONROE... cont

Monroe	Fleetline	GasSLX	Monroe	Fleetline	GasSLX	Monroe	Fleetline	GasSLX	Monroe	Fleetline	GasSLX
65454	85030	89440	65511	85939		66123	83004		66428	85033	89427
65455	85716		65512	85938		66124	83040		66429	85311	89424
65456	85376		65513	85338		66125	83035		66430	83309	89416
65457	85909		65514	85099		66126	83051		66431	85066	89448
65458	85908		65515	85097		6613	83123	89405	66432	85319	89428
65459	85043		65516	85013	89414	66131	83062		66433	85918	89449
65461	85059		65517	83165		66132	83001		66434	85069	89455
65462	85913		65518	85089		6614	83125		66435	83219	
65463	85040		65519	85060		66142	83039		66436	85067	89451
65464	85968		65520	85121		66143	83007		66438	85064	
65465	85939		65521	85014		66145	83008		66442	83150	
65466	85047	89435	65522	85082		66147	83009		66443	83150	
65467	85054	89438	65523	85937		66149	83022		66445	83135	
65468	85069	89455	65524	85936	89456	6615	83120		66486	85066	89448
65469	85708		65525	87015		66150	83003		66502	646155	
65470	85708		65526	85956		66152	83012		66503	646155	
65471	85302	89420	65527	85955		66154	83014		66504	632147	
65472	85330		65528	85069	89455	66157	83015		66535	85062	89408
65473	85329		65529	85984		66159	83031		6658	85009	
65474	85712		65530	85932	89453	66160	83052		66601	83114	
65475	85065		65531	85334		66161	83054		66602	83161	
65476	85736		65532	85967		66162	83025		66603	83103	
65477	85702		65533	85120		66169	83027		66604	83101	
65478	85058	89431	65534	85343		66178	83023		66605	83613	
65479	83122	89406	65536	85965		66179	83013		66606	83636	
65480	83111		65537	85962		66181	83025		66607	85052	
65481	85036	89405	65538	85966		66182	83005		66608	83128	
65482	85006		65539	85961		66189	83041		66609	83635	
65483	85978		6603	83103		66193	83034		66610	83130	
65484	85976		6604	83101		66195	83033		66611	83016	
65485	85972		6605	83613		66196	83027		66612	83017	
65486	85066	89448	6606	83636		66198	83158		66613	83123	89405
65487	85927		6607	85052		66199	83048		66614	83125	
65488	85926		6608	83128		66200	83066		66615	83120	
65489	85331		6609	83635		66204	83024		66616	83018	
65490	85724	89443	6610	85051		66205	83063		66617	83019	
65491	85930		66101	83042		66400	G63432		66618	83159	
65492	85931	89458	66102	83059		66402	83157		66620	83162	
65493	85934		66102	83063		66403	83154		66623	83004	
65494	85061	89450	66103	83046		66405	83154		66624	83141	
65495	85067	89451	66104	83021		66406	85920		66625	83162	
65496	83138		66105	83044		66407	83134		66626	85071	
65497	85933	89454	66106	83016		66408	83145		66627	85045	
65498	85964		66107	83048		66409	83146		66628	83136	
65499	85963		66108	83028		66412	83156		66629	83107	
65500	85738		66109	83048		66415	G63918		66630	83216	
65501	85323	89436	66111	83016		66416	85085		66631	83140	
65502	85938		66112	83017		66417	G63919		66632	83006	
65503	85919		66113	83050		66418	85918	89449	66633	83127	
65504	85072		66114	83045		66419	85931	89458	66634	83203	89436
65505	85006		66115	83045		66422	83163		66636	83127	
65506	85975		66116	83018		66423	85001	89410	66637	83304	
65507	83143		66117	83019		66424	85310	89423	66638	83123	89405
65508	83142		66118	83001		66425	85920		66639	G63610	
65509	85079		66121	83047		66426	85924	89457	66642	G63866	
65510	85052		66122	83038		66427	89441		66643	83007	

**Nota Importante:** Los intercambios deben utilizarse para cuestiones de almacenamiento únicamente. Cuando se identifiquen varios intercambios, consulte la sección de aplicaciones de este catálogo.

## Lista de Intercambios contra Competidores y Equipo Original

### MONROE... cont

Monroe	Fleetline	GasSLX	Monroe	Fleetline	GasSLX	Monroe	Fleetline	GasSLX	Monroe	Fleetline	GasSLX
66645	83008		66860	83308	89435	6864	83104		74069	85301	
66646	83308	89435	66861	83309	89446	6868	G63360		74070	85701	
66647	83009		66863	83314		6878	83221		74073	85320	89429
66648	83112		66864	83104		6886	83124	89407	74074	85722	
66649	83010		66868	83219		6891	83215		74075	85712	
66650	83003		66871	G63605		6893	83203	89436	74076	85706	
66653	G63616		66878	83221		6894	83209	89414	74077	85324	
66654	83014		66883	83314		6895	83204		74078	85027	89418
66656	83110		66884	83125		6897	83126	89430	74079	85336	
66657	83015		66886	83124	89407	6898	83125		74080	85332	
66658	85009		66891	83215		6900	G63386		74081	85727	
66659	83002		66893	83203	89436	6901	G63387		74400	85700	
66660	85059		66894	83137		6902	83401		74402	85711	
66661	83123	89405	66897	83126	89430	6903	83400		74405	85300	89419
66664	83215		66898	83125		6910	G63413		74406	85712	
66665	83109		66902	83401		6911	G63350		74408	85702	
66666	G63671		66903	83400		6912	83304		74409	85310	89423
66668	83313	89439	66912	83304		6913	83303		74410	85701	
66669	83111		66913	83303		6916	83123	89405	74411	85703	
66670	83200		66921	83318		6920	G63411		74412	85704	
66671	83123	89405	66922	83301		6921	83318		74413	85313	
66672	83209	89414	66923	83456	89447	6922	83301		74414	85723	
66677	83114		66924	83317		6923	83456	89447	74415	85318	
66678	83023		66956	83101		6927	G63409		74416	85705	89447
66679	83013		66957	83225		6945	G63421		74417	85311	89424
66680	83317		66966	83353		6956	83101		74418	85709	
66681	83025		66969	83126	89430	6957	83225		74420	85003	89411
66682	83005		6701	83215		6960	G63366		74421	85708	
66683	83101		6707	83215		6969	83126	89430	74422	85733	
66684	85007	89412	6708	83100		6994	83122	89406	74423	85712	
66686	85014		6710	83209	89414	70039	85303	89422	74424	85308	89422
66691	83118		6712	85040		70166	85301		74425	85724	89443
66692	83120		6713	83105		70300	85320	89429	74426	85333	
66693	83034		6714	83216		70312	85001	89410	74427	85308	89422
66695	83033		6715	85026	89417	70331	85314	89425	74429	85919	
66697	83164		6716	85042		70332	83314		74430	85340	
66699	83113		6717	G63616		70334	85316	89426	74431	85341	
66701	83215		6718	85024	89416	70402	85305		74432	85970	
66707	83215		6719	83242		70447	85940		74433	85331	
66708	83100		6720	85003	89411	70447	85949		74434	85711	
66710	83209	89414	6721	83103		70448	85943		74435	87017	
66712	83100		6801	G63484		70449	85942		74436	85334	
66713	83105		6803	G63907		70454	85941		74437	89461	
66714	83216		6811	83312	89409	70459	85948		74438	85734	
66715	85026	89417	6817	G63355		70459	85951		74439	85728	
66716	85042		6824	G63349		70477	85949		74440	85729	
66717	G63616		6828	83219		70720	85934		74441	85339	
66719	83242		6829	83103		74001	85307		74442	85727	
66720	85003	89411	6831	G63359		74003	85314	89425	74443	85377	
66801	83161		6833	83126	89430	74004	85315		74444	85378	
66811	83312	89409	6839	G63357		74006	85304		74445	85381	
66828	83159		6840	83217		74012	85736		74451	85711	
66829	83103		6841	83216		74024	85308	89422	74452	85740	
66833	83126	89430	6860	83308	89435	74025	85303	89422	74453	85339	
66841	83216		6861	83309	89446	74028	85302	89420	74454	85314	89425
66858	G63183		6863	83314		74029	85308	89422	74457	695406	

**Nota Importante:** Los intercambios deben utilizarse para cuestiones de almacenamiento únicamente. Cuando se identifiquen varios intercambios, consulte la sección de aplicaciones de este catálogo.

# Lista de Intercambios contra Competidores y Equipo Original

## MONROE... cont

Monroe	Fleetline	GasSLX	Monroe	Fleetline	GasSLX	Monroe	Fleetline	GasSLX	Monroe	Fleetline	GasSLX
74458	695406		74477	83165		911255	G63894		911280	G64007	
74461	87019		74478	85089		911256	G63893		911508	G64000	
74462	85346		911030	G63479		911257	G63895		911527	G64001	
74463	85347		911171	G63813		911258	G63872		911528	G63965	
74464	85318		911172	G63491		911259	G64016		911533	G63959	
74465	85708		911183	G63832		911260	G63892		911534	G64011	
74466	85318		911184	G63828		911265	G64010		911535	G64013	
74467	85723		911222	G63970		911266	G63886		911536	G64008	
74470	89461		911228	G63882		911267	G63887		911538	G63966	
74471	85736		911229	G63884		911268	G63888		911539	G63967	
74472	85303	89422	911230	G63879		911270	G63885		SC-2920	83176	
74473	85716		911251	G63878		911277	G63890				
74475	85746		911252	G63883		911278	G64012				
74476	85745		911253	G63875		911279	G63889				

## MOR-RYDE SUSPENSION

# E.O.	Fleetline	GasSLX	# E.O.	Fleetline	GasSLX	# E.O.	Fleetline	GasSLX	# E.O.	Fleetline	GasSLX
U0109-006	G63866		U0109-007	G63183		U0109-014	83400		U0109-018	G63866	

## MOTOR COACH INDUSTRIES

# E.O.	Fleetline	GasSLX	# E.O.	Fleetline	GasSLX	# E.O.	Fleetline	GasSLX	# E.O.	Fleetline	GasSLX
12-05-1021	85340		12-05-6055	85339		1497835	85711		680544	85711	
12-05-1022	85970		12-05-6068	85727		1498200	85740		680546	85339	
12-05-1023	85341		12-5-1-G	85700		1498565	85339		680602	85339	
12-05-1101	85340		12-5-1-GS	85700		22012066	85707		680677	85728	
12-05-1102	85970		12B-5-1	85735		22012067	85700		680680	85729	
12-05-1103	85341		12B-5-1-G	85700		22012079	85701		680681	85727	
12-05-1137	85340		12B-5-1-GS	85700		22024061	85704		690029	85700	
12-05-1138	85970		12G-5-1	85700		22024673	85710		695117	85701	
12-05-1139	85341		12J-5-10	85733		22045526	85702		695125	85704	
12-05-1142	85340		12J-5-10GS	85733		22046485	85710		74410	85701	
12-05-1146	85340		12J-5-11	85313		22052014	85702		85729	85729	
12-05-1147	85341		12J-5-2	85312		3178154	85735		97-2201-00151	85700	
12-05-1148	85970		12J-5-3	85313		3178157	85700		97-2210-00164	85708	
12-05-1150	85711		12J-5-4	85312		4975515	85701		97-9999-02514	85700	
12-05-1165	85711		12J-5-6	85313		4975515GS	85701		97-9999-02585	85723	
12-05-1166	85341		12J-5-7	85312		5316984	85313		97-9999-02634	85733	
12-05-1170	85340		12J-5-71	85733		63-0127GS	85303	89422	G1011822	85702	
12-05-1176	85728		12J-5-9	85700		6314933	85708		G1101590	85713	
12-05-1177	85729		12L-4-170	83158		654789	83158		G1101590GS	85713	
12-05-1178	85339		12L-5-100	85727		680231	85313		G1201338	85710	
12-05-1179	85727		12L-5-114	85727		680232	85733		G1201339	85702	
12-05-1188	85970		12L-5-58	85728		680322	85704		G5008069	85700	
12-05-1194	85339		12L-5-67	85728		680323	85700		OE10086S	85702	
12-05-1199	85729		12L-5-69	85700		680332	85701		OE10881	85711	
12-05-1228	85711		12L-5-70	85700		680333	85708		OE10882	85740	
12-05-1242	85728		12L-5-71	85708		680350	85710		OE10883	85339	
12-05-1243	85729		12L-5-88	85729		680369	85708		T14-1029	85701	
12-05-1244	85727		12L-5-89	85729		680374	85728		T14-1045GS	85700	
12-05-6000	85711		12L-5-96	85728		680441	85729		T14-1048	85302	89420
12-05-6001	85740		12L-5-97	85728		680452	85339		T14-1080	85728	
12-05-6002	85339		12L-5-98	85339		680462	85728		T14-1081	85729	
12-05-6033	85339		12L-5-99	85339		680470	85713		T14-1082	85727	
12-05-6053	85711		12T-1-13	85303	89422	680482	85727				
12-05-6054	85740		12TA-01-013	85303	89422	680485	85733				

## MOTORCRAFT

Motorcraft	Fleetline	GasSLX	Motorcraft	Fleetline	GasSLX	Motorcraft	Fleetline	GasSLX	Motorcraft	Fleetline	GasSLX
AA-229	G63773		AA-456	G63772							
AA-450	G63773		AA-457	G63678							

**Nota Importante:** Los intercambios deben utilizarse para cuestiones de almacenamiento únicamente. Cuando se identifiquen varios intercambios, consulte la sección de aplicaciones de este catálogo.

## Lista de Intercambios contra Competidores y Equipo Original

### MOTORCRAFT... cont

Motorcraft	Fleetline	GasSLX	Motorcraft	Fleetline	GasSLX	Motorcraft	Fleetline	GasSLX	Motorcraft	Fleetline	GasSLX
AA-494	83131		ASHV-865	G63808		CAHL-409	85310	89423	CAT-927	G63409	
AA-615	83135		ASHV-866	G63810		CAHL-417	85311	89424	CAT-927	G63690	
AA-616	83175		ASHV-867	G63455		CAT-722	83400		CAT-928	G63410	
AA-617	85928		ASHV-868	G63406		CAT-729	G63414		CAT-929	G63403	
AS-1086	G63678		ASHV-871	G63809		CAT-730	G63386		CAT-930	G63461	
AS-413	G63414		ASHV-879	G63455		CAT-731	G63409		CAT-932	G63398	
AS-433	G63406		AST-260	G63929		CAT-732	G63455		CAT-935	G63424	
AS-485G	G63622		AT-163G	83177		CAT-733	G63617		CAT-936	G63425	
AS-498G	G63608		AT-164G	83178		CAT-736	G63394		CAT-944	G63347	
AS-500G	G63624		AT-504G	G63679		CAT-737	G63502		CAT-944	G63908	
ASH-1022	83209	89414	AT-506G	G63679		CAT-739	G63603		CAT-945	G63421	
ASH-1023	83122	89406	AT-507G	G63607		CAT-740	G63423		CAT-945	G63457	
ASH-1130	G63622		AT-546	G63678		CAT-741	G63489		CAT-948	G63909	
ASH-1131	G63622		AT-547	G63775		CAT-745	G63608		CAT-953	G63375	
ASH-1132	G63622		AT-554	85305		CAT-745	G63614		CAT-953	G63900	
ASH-1135	G63623		AT-568	G63622		CAT-750	G63359		CAT-953	G63903	
ASH-1136	83178		AT-579	G63809		CAT-751	G63607		CAT-955	G63454	
ASH-1154	83177		AT-610	G63461		CAT-758	G63909		CAT-958	G63377	
ASH-1155	G63623		AT-611	G63461		CAT-759	G63624		CAT-960	G63366	
ASH-1228	83209	89414	AT-621	83122	89406	CAT-760	G63622		CAT-963	G63427	
ASH-1230	83122	89406	AT-682	G63678		CAT-761	G63623		CAT-963	G63525	
ASH-137	83122	89406	AT-683	G63679		CAT-762	G63638		CAT-964	G63420	
ASH-25	83309	89446	AT-684	G63679		CAT-768	83209	89414	CAT-964	G63456	
ASH-29	83314		AT-685	G63679		CAT-776	G63661		CAT-972	G63610	
ASH-294	83209	89414	AT-696	83140		CAT-777	G63662		CAT-975	G63511	
ASH-32	83125		AT-764	G63678		CAT-778	G63673		CAT-976	G63490	
ASH-322	77969		AT-765	G63772		CAT-793	G63414		CAT-977	G63915	
ASH-324	77968		AT-766	83209	89414	CAT-802	G63419		CAT-978	G63460	
ASH-335	G63969		AT-811	83135		CAT-802	G63492		CAT-983	G63489	
ASH-36	85716		AX-131A	83217		CAT-802	G63928		CAT-984	G63609	
ASH-362	G63607		AX-135A	G63406		CAT-803	G63306		CAT-984	G63818	
ASH-363	G63525		AX-267A	83309	89446	CAT-817	G63355		CAT-985	G63488	
ASH-364	G63524		AX-269A	83308	89435	CAT-824	G63349		CAT-986	G63489	
ASH-365	G63772		AX-269A	83312	89409	CAT-826	G63187		CAT-990	G63906	
ASH-366	G63608		AX-277A	83219		CAT-828	G63494		CAX-001	85307	
ASH-38	85314	89425	AX-282A	85010		CAT-831	G63359		CAX-707	83215	
ASH-387	G63809		AX-310	83215		CAT-832	G63353		CAX-707	85001	89410
ASH-39	85001	89410	AX-327	G63773		CAT-839	G63357		CAX-710	83209	89414
ASH-408	G63809		AX-79A	83221		CAT-853	G63183		CAX-720	85003	89411
ASH-51	G63773		AX-79A	85030	89440	CAT-854	G63389		CAX-811	83312	89409
ASH-684	G63623		AX-97A	83122	89406	CAT-868	G63360		CAX-828	83207	89407
ASH-824	G63929		AX-97A	85005	89430	CAT-895	83207	89407	CAX-828	85012	89413
ASHV-1	G63678		CAH-001	85307		CAT-899	G63500		CAX-833	83303	
ASHV-1015	G63622		CAH-001	85711		CAT-900	G63386		CAX-833	85005	89430
ASHV-1025	G63623		CAH-003	83215		CAT-901	G63387		CAX-841	83216	
ASHV-1028	G63778		CAH-006	85304		CAT-904	G63299		CAX-860	83308	89435
ASHV-1046	G63772		CAH-012	85736		CAT-905	G63405		CAX-861	83309	89446
ASHV-1047	G63607		CAH-025	85007	89412	CAT-906	G63396		CAX-863	83314	
ASHV-1048	G63525		CAH-028	85302	89420	CAT-907	G63511		CAX-878	83221	
ASHV-1049	G63524		CAH-029	85308	89422	CAT-909	G63398		CAX-886	83207	89407
ASHV-1050	G63608		CAH-069	83219		CAT-910	G63413		CAX-886	85014	
ASHV-13	G63676		CAH-069	85301		CAT-911	G63350		CAX-891	83215	
ASHV-14	G63837		CAHL-400	85303	89422	CAT-912	G63625		CAX-891	85314	89425
ASHV-3	G63714		CAHL-400	85700		CAT-919	G63411		CAX-893	83203	89436
ASHV-4	G63716		CAHL-405	85300	89419	CAT-920	G63675		CAX-893	85000	89436
ASHV-864	G63929		CAHL-406	85004		CAT-926	G63410		CAX-893	85043	

**Nota Importante:** Los intercambios deben utilizarse para cuestiones de almacenamiento únicamente. Cuando se identifiquen varios intercambios, consulte la sección de aplicaciones de este catálogo.

# Lista de Intercambios contra Competidores y Equipo Original

## MOTORCRAFT... cont

Motorcraft	Fleetline	GasSLX	Motorcraft	Fleetline	GasSLX	Motorcraft	Fleetline	GasSLX	Motorcraft	Fleetline	GasSLX
CAX-894	83209	89414	CAX-916	83123	89405	CAX-957	83225		CLT-114	G63635	
CAX-894	85005	89430	CAX-916	85036	89405	CAX-969	83221		CLT-116	G63902	
CAX-894	85013	89414	CAX-921	83318		CAX-969	85011		CLT-124	G63610	
CAX-898	83125		CAX-923	83102		CAX-969	85030	89440	CLT-138	G63502	
CAX-898	85006		CAX-923	83456	89447	CLT-109	G63614				
CAX-912	83304		CAX-924	83317		CLT-112	G63525				
CAX-913	83303		CAX-957	83217		CLT-113	G63524				

## MUNCIE RECLAMATION

# E.O.	Fleetline	GasSLX	# E.O.	Fleetline	GasSLX	# E.O.	Fleetline	GasSLX	# E.O.	Fleetline	GasSLX
665459	89447		MR1623	85700		MR2961	85701		MR3307	85707	
665568	85051		MR1710	85713		MR2996	85704		MR3650	85707	
665569	85045		MR1751	85713		MR2997	85703		MR6394	85723	
680334	85709		MR1763	85300	89419	MR3303	85709		MR6396	85982	
97-2210-00164	85708		MR1765	85713		MR3304	85710		MR6535	85708	
H53-20415-006	85051		MR25767	85702		MR3304H	85709		MR6536	85722	
H53-21144-004	85045		MR2960	85702		MR3306	85705	89447	MR7388	85710	

## NATIONAL COACH CORP

# E.O.	Fleetline	GasSLX	# E.O.	Fleetline	GasSLX	# E.O.	Fleetline	GasSLX	# E.O.	Fleetline	GasSLX
C800853	83207	89407									

## NEOPLAN BUS

# E.O.	Fleetline	GasSLX	# E.O.	Fleetline	GasSLX	# E.O.	Fleetline	GasSLX	# E.O.	Fleetline	GasSLX
24-1700-106-149	83216		AA1002002	85705	89447	BN1002002	85009		DZ1002002	85705	89447
24-1700-999-362	85009		AA1002003	85705	89447	BT1002011	83216		GJ1002002	85706	
25-1700-101-426	85705	89447	AA1802002	85705	89447	CI 1002003	85705	89447	GJ1002003	85705	89447
680307	85705	89447	AC1002002	85705	89447	CL1002003	85705	89447	MM1002002	85705	89447
680308	85706		AC1002002GS	85705	89447	DT1002002	85707		MM1002003	85705	89447
97-9999-02519	85707		AC1002003	85705	89447	DT1802002	85705	89447			

## NEW FLYER

# E.O.	Fleetline	GasSLX	# E.O.	Fleetline	GasSLX	# E.O.	Fleetline	GasSLX	# E.O.	Fleetline	GasSLX
009863	85722		064845	85711		680346	85722		97-2210-00164	85708	
015813	85708		152959	85708		680352	85711		G1011823	85710	
015915	85711		203398	85346		680671	85708				
016415	85722		204428	85347		690102	85711				

## NEWMAR CORP

# E.O.	Fleetline	GasSLX	# E.O.	Fleetline	GasSLX	# E.O.	Fleetline	GasSLX	# E.O.	Fleetline	GasSLX
141700131809	85029		16-16736-000	85029		16-16874-000	83160		481700000493	85900	
141700131810	83160		16-16737-000	83160		16-18103-000	85900				

## NISSAN

# E.O.	Fleetline	GasSLX	# E.O.	Fleetline	GasSLX	# E.O.	Fleetline	GasSLX	# E.O.	Fleetline	GasSLX
56101-30Z01	83161		56110-30Z01	83161		56110-Z5008	83114		56210-Z5001	85085	
56101-30Z02	G63610		56110-30Z02	G63610		56110-Z5011	G63610		66400	G63432	
56101-Z5008	83114		56110-T8123	G63432		56110-Z5017	83162				
56101-Z5017	83162		56110-T8129	G63432		56201-Z5001	85085				

## NOVA BUS

# E.O.	Fleetline	GasSLX	# E.O.	Fleetline	GasSLX	# E.O.	Fleetline	GasSLX	# E.O.	Fleetline	GasSLX
12J-5-10	85733		680231	85313		97-2201-00151	85700		G1205763-001	87019	
12J-5-11	85313		680232	85733		97-9999-02514	85700		G5008070	85700	
22012079	85701		680323	85700		G1011822	85702		N16248	85377	
22024673	85710		680326	85700		G1011823	85710		N16249	85378	
22045526	85702		680470	85713		G1101590	85713		N21543	85378	
22052014	85702		680480	85377		G1201338	85710		N22212	85700	
481700131250	85377		680481	85378		G1201339	85702		N31830	85378	
481700131252	85378		695117	85701		G1203223	85702		N31831	85377	
4975515	85701		74410	85701		G1205763	87019		OE 10086S	85702	

**Nota Importante:** Los intercambios deben utilizarse para cuestiones de almacenamiento únicamente. Cuando se identifiquen varios intercambios, consulte la sección de aplicaciones de este catálogo.

## Lista de Intercambios contra Competidores y Equipo Original

### OLE GRANNING

# E.O.	Fleetline	GasSLX	# E.O.	Fleetline	GasSLX	# E.O.	Fleetline	GasSLX	# E.O.	Fleetline	GasSLX
1086	83217										

### OPTIMA BUS CORP

# E.O.	Fleetline	GasSLX	# E.O.	Fleetline	GasSLX	# E.O.	Fleetline	GasSLX	# E.O.	Fleetline	GasSLX
1260008	87017		90-2610-SP1	87017							

### ORION BUS INDUSTRIES

# E.O.	Fleetline	GasSLX	# E.O.	Fleetline	GasSLX	# E.O.	Fleetline	GasSLX	# E.O.	Fleetline	GasSLX
010134501-4	85307		0501345-11	85718		070231514	85729		680505	85717	
010134504-4	85715		050134501-4	85716		070231527	85729		680506	85718	
010134505-4	85715		050134502-4	85718		20117501	85720		690102	85711	
010134506-4	85717		050134506-4	85718		20117503	85720		695327	85732	
010134508-4	85718		050134508	85718		20117504	85720		695343	85732	
010134509	85717		050134509	85732		20117505	85720		695347	85732	
010234503-4	85308	89422	050134510	85732		665596	85719		695366	85732	
010234506	85714		050134513	85732		680091	85303	89422	695389	87016	
020117504	85720		050230501	85716		680102	85712		695420	85729	
020273541	83203	89436	050231502-4	85716		680271	85714		695421	87016	
020273541-4	85000	89436	050231505	85716		680274	85716		695440	85729	
020273544	83203	89436	050231507	85716		680328	85717		97-9999-02635	85718	
020273546	85719		060131507	87016		680352	85711		97-9999-02636	85716	
020273547	85719		060131508	87016		680378	85720		A-4890	85712	
020273547-4	85719		060231508	85717		680501	85714		OB020570	85711	
020273548	85719		070131502	87016		680502	85715		OB020764	85716	
020273549	85719		070131506	87016		680504	85716		OB3166657	85700	

### OSHKOSH MOTORS

# E.O.	Fleetline	GasSLX	# E.O.	Fleetline	GasSLX	# E.O.	Fleetline	GasSLX	# E.O.	Fleetline	GasSLX
12405F	85734		1745500		89430	40-4951	85316	89426	665060	83122	89406
12405F-1	85303	89422	2034140	646177		40-5348	85058	89431	690049	85303	89422
12405FX1	85303	89422	2173340	85303	89422	40-6967	85030	89440	90044448	85051	
1398980	83127		26228-A	83122	89406	4036892	G63605		GBL654875	83117	
1445910	85300	89419	2JD137	83119		5353054	85303	89422	GBL654918	83118	
1573270	83207	89407	3638112	G63183		5361994	85734		P117099	83120	
1573280	83221		40-0242	83312	89409	651444	83221		P117146	83118	
1583470	85051		40-4845	85304		665040	85303	89422	RW24285	83119	

### OSHKOSH MOTORS AMORTIGUADORES DE CABINA

# E.O.	Fleetline	GasSLX	# E.O.	Fleetline	GasSLX	# E.O.	Fleetline	GasSLX	# E.O.	Fleetline	GasSLX
1202-0054	83021		2218640	83009							

### OSTERLUND TRUCK

# E.O.	Fleetline	GasSLX	# E.O.	Fleetline	GasSLX	# E.O.	Fleetline	GasSLX	# E.O.	Fleetline	GasSLX
220-S5-10	85712		59011	83214		680117	85300	89419			

### OTTAWA TRUCK

# E.O.	Fleetline	GasSLX	# E.O.	Fleetline	GasSLX	# E.O.	Fleetline	GasSLX	# E.O.	Fleetline	GasSLX
53540451	85300	89419	59011	83214		90013787	85310	89423	9007342	85303	89422
59009	83217		680117	85300	89419	90027577	85720				

### PACCAR

# E.O.	Fleetline	GasSLX	# E.O.	Fleetline	GasSLX	# E.O.	Fleetline	GasSLX	# E.O.	Fleetline	GasSLX
665633	85033	89427									

### PACIFIC TRUCK & TRAILER

# E.O.	Fleetline	GasSLX	# E.O.	Fleetline	GasSLX	# E.O.	Fleetline	GasSLX	# E.O.	Fleetline	GasSLX
3178157C	85735		507202C1	85030	89440						

### PAGE SUSPENSION

# E.O.	Fleetline	GasSLX	# E.O.	Fleetline	GasSLX	# E.O.	Fleetline	GasSLX	# E.O.	Fleetline	GasSLX
1080099	83203	89436	665133	83203	89436	A-2212	85029				
1081933	83204		665267	85029							

### PAI CORP

# E.O.	Fleetline	GasSLX	# E.O.	Fleetline	GasSLX	# E.O.	Fleetline	GasSLX	# E.O.	Fleetline	GasSLX
HSA-5067	85305		HSA-5080	83221		HSA-5095	83215				

**Nota Importante:** Los intercambios deben utilizarse para cuestiones de almacenamiento únicamente. Cuando se identifiquen varios intercambios, consulte la sección de aplicaciones de este catálogo.

## Lista de Intercambios contra Competidores y Equipo Original

PAI CORP... cont

### PEERLESS TRAILER

# E.O.	Fleetline	GasSLX	# E.O.	Fleetline	GasSLX	# E.O.	Fleetline	GasSLX	# E.O.	Fleetline	GasSLX
120-1	83125		72-61	83125							

### PETERBILT

# E.O.	Fleetline	GasSLX	# E.O.	Fleetline	GasSLX	# E.O.	Fleetline	GasSLX	# E.O.	Fleetline	GasSLX
02-00376	85302	89420	12887-02	85013	89414	665945	85902		B71-1002	85001	89410
02-00495	85302	89420	16-13947-000PLUS	85319	89428	665950	85902		B71-1003	83312	89409
02-01787	85062	89408	16725-01	83221		671052	85070	89459	B71-6000	85920	
02-01890	85012	89413	2018987C1PLUS	85003	89411	671091	85069	89455	B71-6002	85012	89413
02-02061	85013	89414	23-08233	85308	89422	671092	85012	89413	B71-6003	85029	
02-02142	85036	89405	23-10393	85308	89422	671654	85936	89456	B71-6004	85084	89460
02-02225	85012	89413	23-12262	85012	89413	671699	85937		B71-6005	85084	89460
02-02736	85302	89420	47902-13PLUS	83122	89406	671794	85067	89451	B71-6006	85084	89460
02-02736PLUS	85302	89420	60670-005PLUS	83121		671962PLUS	85936	89456	B71-6007	85062	89408
02-02737	85062	89408	60670-008PLUS	83123	89405	671963	85937		B71-6008	83312	89409
02-02737PLUS	85062	89408	60680-004	83143		680026	85302	89420	B71-6009	83219	89408
02-02738	85012	89413	60680-005	83142		680027	85308	89422	B71-6009	85062	89408
02-02738PLUS	85012	89413	665133	83203	89436	680185	85308	89422	B71-6010	85023	89415
02-02739	85013	89414	665174	85060		680237	85303	89422	B71-6011	85062	89408
02-02739PLUS	85013	89414	665565PLUS	85007	89412	680239	85310	89423	B71-6012	85119	
02-02740	85036	89405	665617	85031		680240	85302	89420	B71-6013	85012	89413
02-02741	85012	89413	665632	85013	89414	680241	85311	89424	B71-6015	85012	89413
02-02742	85062	89408	665633	85033	89427	680242	85308	89422	B71-6016	85012	89413
02-03020	85910		665655	85062	89408	680253	85314	89425	B71-6016A	85012	89413
02-04010	85012	89413	665656	85012	89413	680261	85062	89408	B71-6017	85910	
03-01635	85308	89422	665657	85013	89414	680279	83209	89414	B71-6018	85012	89413
03-04176	85308	89422	665658	85036	89405	680280	85906	89407	B71-6019	85989	
03-04176PLUS	85308	89422	665660	85033	89427	680281	85003	89411	C71-1002	85067	89451
03-04628	85336		665662	85012	89413	680283	83353		C71-1002PLUS	85067	89451
03-04629	85311	89424	665738	85910		680303	85007	89412	C71-1011	85069	89455
03-05106	85033	89427	665752	85067	89451	680348	85012	89413	C71-1011PLUS	85069	89455
03-05384	85033	89427	665762	85012	89413	680425	85320	89429	C71-1013	85985	
03-06084	85033	89427	665783	83123	89405	680435	85033	89427	C71-1014	85936	89456
03-06084PLUS	85033	89427	665784	83122	89406	680457	85302	89420	C71-1015	85937	
03-07281	85311	89424	665785	83137		680458	85336		C71-1016	85067	89451
03-07420	85336		665788	85000	89436	680459	85311	89424	C71-1017	85069	89455
03-07421	85311	89424	665826	85069	89455	680473	85319	89428	C71-6000	85067	89451
03-07421PLUS	85311	89424	665844	85069	89455	680586	85311	89424	C71-6002	85311	89424
03-07423	85033	89427	665858	85070	89459	70701PLUS	85900		C71-6003	85988	
03-07423PLUS	85033	89427	665876	85959		800670	85060		C71-6004	85343	
03-07424	85311	89424	665918	85900		8086053PLUS	85047	89435	C71-6005	85069	89455
03-07424PLUS	85311	89424	665926	85047	89435	90044011	85004		K374-26PLUS	85001	89410
03-08350	85343		665927	85901		90044025PLUS	83209	89414	K374-28PLUS	85314	89425
03-08781	85069	89455	665928	85062	89408	90044089PLUS	83124	89407	K374-29PLUS	85310	89423
10-12032-002PLUS	85320	89429	665930	85001	89410	ACHB966	83136		K374-33PLUS	83312	89409
10-12542-000PLUS	85901		665931	83312	89409	B71-1000	85031		K374-38	85996	
12887-01	85013	89414	665932	85012	89413	B71-1001	85070	89459	K374-41	85997	

### PETERBILT AMORTIGUADORES DE CABINA

# E.O.	Fleetline	GasSLX	# E.O.	Fleetline	GasSLX	# E.O.	Fleetline	GasSLX	# E.O.	Fleetline	GasSLX
1201-0012	83023		20-16755	83042		654919	83035		R71-6005	83042	
1202-0012	83023		20-19140	83063		96027-1054	83011		R71-6006	83063	
1202-0022	83046		29-02455	83008		PP1058870	83059		R71-6007	83008	
1202-0032	83016		29-06005	83035		PP1059870	83060		R71-6008	83035	
1202-0054	83021		29-06032	83035		PP2582870	83012				
1202-1044	83025		654782	83008		R71-1004	83049				
1202P055	83061		654812	83042		R71-1005	83024				

**Nota importante:** Los intercambios deben utilizarse para cuestiones de almacenamiento únicamente. Cuando se identifiquen varios intercambios, consulte la sección de aplicaciones de este catálogo.



## Lista de Intercambios contra Competidores y Equipo Original

### PIERCE MANUFACTURING INC.

# E.O.	Fleetline	GasSLX	# E.O.	Fleetline	GasSLX	# E.O.	Fleetline	GasSLX	# E.O.	Fleetline	GasSLX
1445910	85300	89419	40-0242	83312	89409	40-4951	85316	89426	40-6967	85030	89440
2034140	646177		40-4845	85304		40-5348	85058	89431	680401	85307	

### POWERPACKER AMORTIGUADORES DE CABINA

# E.O.	Fleetline	GasSLX	# E.O.	Fleetline	GasSLX	# E.O.	Fleetline	GasSLX	# E.O.	Fleetline	GasSLX
PP1058870	83059		PP1059870	83060							

### PREVOST

# E.O.	Fleetline	GasSLX	# E.O.	Fleetline	GasSLX	# E.O.	Fleetline	GasSLX	# E.O.	Fleetline	GasSLX
01-0100-905	85303	89422	481700000209	85713		630136	85330		680422	85329	
0822045526	85702		481700999376	85329		630161	85736		680492	85713	
12B-5-1	85735		481700999377	85330		630163	85330		680510	85330	
12L-5-89	85729		481700999386	85736		630228	85380		680555	85330	
12T-1-13	85303	89422	481700999427	85380		630234	85329		680583	85380	
19501288	85729		52001	85708		630235	85330		690060	85713	
19501289	85728		63-1013	85329		630236	85329		74939852	85308	89422
196347	85710		630001	85713		630251	85379		G1011822	85702	
196533	85708		630080	85713		630252	85329		G5008070	85700	
3166657	85700		630091	85736		630253	85713		N16249	85378	
481700000206	85380		630103	85329		630254	85380		N22212	85700	
481700000207	85329		630127	85736		650407	85736				
481700000208	85379		630134	85329		680323	85700				

### RAMERIZ TRAILER

# E.O.	Fleetline	GasSLX	# E.O.	Fleetline	GasSLX	# E.O.	Fleetline	GasSLX	# E.O.	Fleetline	GasSLX
18165-01	85006										

### RAYDAN MANUFACTURING

# E.O.	Fleetline	GasSLX	# E.O.	Fleetline	GasSLX	# E.O.	Fleetline	GasSLX	# E.O.	Fleetline	GasSLX
14QK-3100	85739		446-51-211	85739		700115	85712				

### RED LION TRAILER

# E.O.	Fleetline	GasSLX	# E.O.	Fleetline	GasSLX	# E.O.	Fleetline	GasSLX	# E.O.	Fleetline	GasSLX
90044978	85059		90045019	85913							

### REX MIXER

# E.O.	Fleetline	GasSLX	# E.O.	Fleetline	GasSLX	# E.O.	Fleetline	GasSLX	# E.O.	Fleetline	GasSLX
102-13441-10	646155										

### REYCO SUSPENSION

# E.O.	Fleetline	GasSLX	# E.O.	Fleetline	GasSLX	# E.O.	Fleetline	GasSLX	# E.O.	Fleetline	GasSLX
12885-01	85300	89419	17794-01	83215		20960-01	83204		665833	85052	
12885-03	85300	89419	18146-01	85313		21310-01	85307		671707	85052	
12886-01	85334		18163-01	83207	89407	21497-01	85005	89430	680551	85738	
12887-01	85013	89414	18164-01	83122	89406	22062-01	85007	89412	680552	85938	
12887-02	85013	89414	18165-01	85006		23106-01	85975		680700	85938	
14954-01	83217		18166-01	85704		23523-01	85086		700098-01	83203	89436
16230-01	85702		18286-01		89414	23524-01	85738		700098-03	85052	
16725-01	83221		18800-01	83203	89436	23553-01	85938		701071-01	665937	
16824-01	85006		19495-01	83126	89440	23614-01	85717		702135-01	85045	
17142-01	85001	89410	19623-01	83123	89405	24392-01	85051		702136-01	85052	
17146-01	83209	89414	19824-01	85006		665519		89414	702209-01	85014	
17358-01	83126	89430	20125-01	85030	89440	665748	85086		704672-01	85938	
17403-01	83122	89406	20126-01		89440	665813	85051				
17408-01	85005	89430	20129-01	85007	89412	665830	85045				

### RIDEWELL CORPORATION

# E.O.	Fleetline	GasSLX	# E.O.	Fleetline	GasSLX	# E.O.	Fleetline	GasSLX	# E.O.	Fleetline	GasSLX
1250005	85901		1254190B000	85302	89420	1267395B000	85302	89420	1310002	665937	
1250546B000	85006		1260008	87017		1270007	85045		1310004	665937	
1250563B000	85000	89436	12651527B000	85712		1270563B000	85000	89436	1317570B001	646155	
1250789B000	85014		1265478B000	85736		1270563B003	85934				
1252607B000	85702		1266009B000	83130		1270789B000	85014				
1253069B000	85005	89430	1267120B000	85734		1275813B000	85704				
1254025B000	85712		1267249B000	85712		1275943B	85005	89430			

**Nota Importante:** Los intercambios deben utilizarse para cuestiones de almacenamiento únicamente. Cuando se identifiquen varios intercambios, consulte la sección de aplicaciones de este catálogo.

# Lista de Intercambios contra Competidores y Equipo Original

## RIDEWELL CORPORATION... cont

# E.O.	Fleetline	GasSLX	# E.O.	Fleetline	GasSLX	# E.O.	Fleetline	GasSLX	# E.O.	Fleetline	GasSLX
57645	85005	89430	AS 4025B	85712		AS789B000	85014		S6009B	83203	89436
665198	85005	89430	AS30698	85005	89430	S2607B	85702		S7120B	85304	
665267	85029		AS3069B	85005	89430	S4025B	85712		S7172B	83207	89407
665526	85014		AS546B	85006		S5477B	85307		S7249B	85307	
680101	85702		AS563B	83203	89436	S5478B	85307		S7365B	85305	
70654	85000	89436	AS575B	85005	89430	S5813B	85704				
90-2610 SP1	87017		AS789B	85014		S5878B	83207	89407			

## ROADMASTER (MONACO)

# E.O.	Fleetline	GasSLX	# E.O.	Fleetline	GasSLX	# E.O.	Fleetline	GasSLX	# E.O.	Fleetline	GasSLX
90045132	85909		90045188	85910							

## SACHS

Sachs	Fleetline	GasSLX	Sachs	Fleetline	GasSLX	Sachs	Fleetline	GasSLX	Sachs	Fleetline	GasSLX
101892	85708		315392	85007	89412	315553	85900		410023	85103	
101968	85708		315393	85331		315554	85006		410024	85302	89420
106-884	85708		315394	85921		315555	83038		410025	83215	
106282	85722		315395	85724	89443	315556	85314	89425	410026	85918	89449
106884	85708		315396	85335		315593	85029		410032	85320	89429
106885	85722		315397	83120		315594	85029		410035	85001	
112-885	85709		315398	85058	89431	315597	85959		410035	85337	
124693	85708		315399	85005	89430	315598	85933	89454	410036	85061	89450
141700000373	85061	89450	315400	85006		315600	85959		410037	85081	
141700000377	83174		315403	85919		315601	85920		410038	85100	
141700000378	83160		315404	85900		315602	85092		410040	85005	89430
141700000380	85061	89450	315406	85918	89449	315603	83134		410042	85310	89423
141700000443	85066	89448	315411	83128		315606	85061	89450	410043	85957	
141700000901	83165		315414	85959		315607	85061	89450	410044	85031	
141700002626	85061	89450	315415	85933	89454	315608	85061	89450	410046	83136	
141700005838	85098		315416	85003	89411	315609	85066	89448	410047	85071	
141700005839	85098		315417	85923		315610	83026		410048	83207	
141700125243	85089		315418	83456	89447	315611	85337		410048	83304	
141700125275	83165		315420	85014		315612	85006		410048	85014	
141700131809	85029		315421	85088		315613	85030	89440	410050	85121	
141700131810	83160		315423	83127		315614	85097		410051	85108	
141700131975	83160		315424	85067	89451	315615	83027		410052	85096	
170210	83104		315425	85330		315616	83038		410053	85095	
170211	83104		315426	85329		315618	83160		410056	85000	89436
280499	85300	89419	315427	85713		315619	83160		410057	83137	
290146	85012	89413	315428	85380		315620	85080		410058	83122	
290460	85005	89430	315430	85099		315621	85080		410068	85030	89440
290465	83125		315431	85014		315622	85081		410068	85054	
290488	85040		315432	89414		315623	85918		410069	83165	
311229	85918	89449	315434	85065		315625	85975		410069	85094	
311230	85956		315435	85088		315626	85933	89454	410070	85089	
311631	85906	89407	315540	83613		315656	83040		471700000426	85014	
311632	85909		315541	85052		315657	83039		471700000428	85006	
311633	85900		315542	83122	89406	315658	83057		471700000431	85066	89448
311634	85001	89410	315543	83125		315659	83047		471700000433	85099	
311635	85030	89440	315544	85014		315660	83009		471700000436	85030	89440
311793	85975		315545	85333		315661	85932	89453	471700000440	85959	
311794	85974		315546	85005	89430	40-A85-0	85708		471700000443	85066	89448
312724	85311		315547	85924	89457	410 011	83173		471700000445	85080	
313708	85378		315548	85070	89459	410 038	85100		471700000447	85919	
313709	85377		315549	85033	89427	410010	83317		471700000449	85918	89449
315389	85090		315550	85311	89424	410011	85093		471700000451	85080	
315390	85958		315551	85310	89423	410021	83125		471700000458	85014	
315391	85956		315552	83128		410022	85006		471700000459	85030	89440

**Nota Importante:** Los intercambios deben utilizarse para cuestiones de almacenamiento únicamente. Cuando se identifiquen varios intercambios, consulte la sección de aplicaciones de este catálogo.

## Lista de Intercambios contra Competidores y Equipo Original

### SACHS... cont

Sachs	Fleetline	GasSLX	Sachs	Fleetline	GasSLX	Sachs	Fleetline	GasSLX	Sachs	Fleetline	GasSLX
471700000460	85097		471700004270	85117		481700000477	85900		510005	85303	
471700000461	89414		471700004423	85109		481700000483	85975		510006	85705	
471700000464	85090		471700005079	85005	89430	481700000484	85974		510006	85706	
471700000466	85959		471700006039	85088		481700000485	85975		510009	85711	
471700000470	85918	89449	471700006040	85088		481700000493	85900		510011	87020	
471700002627	85066	89448	471700006269	85932	89453	481700004271	85993		510017	85323	89436
471700002726	85918	89449	471700125245	85089		481700004476	85982		510018	85724	89443
471700002809	85724	89443	471700131155	85918	89449	481700125969	85956		510019	85916	
471700002861	85014		471700131256	85065		481700131250	85377		510023	85316	89426
471700002919	85106		471700131258	85081		481700131252	85378		510024	85381	
471700002990	85007		471700131331	85932	89453	481700131438	85919		510039	85982	
471700002991	85959		471700131545	85006		481700131919	85900		510040	85110	
471700002992	85331		471700131646	85918	89449	481700999376	85329		814903003482	83040	
471700002993	85921		471700131775	85006		481700999377	85330		814903003483	83039	
471700002994	83134		471700131920	85933	89454	481700999386	85376		814903003484	83057	
471700002995	83134		471700131921	85933	89454	481700999427	85380		814903003486	83047	
471700002996	85335		471700131974	85029		510001	85716		814903003496	83009	
471700003009	85006		481700000206	85380		510002	85302	89420	814903003500	83026	
471700003011	85058		481700000207	85329		510002	85983		814903003501	83027	
471700003832	85933	89454	481700000208	85379		510003	85004		814903003528	83038	
471700003920	85958		481700000209	85713		510004	85307		823196420	85100	

### SAF HOLLAND

# E.O.	Fleetline	GasSLX	# E.O.	Fleetline	GasSLX	# E.O.	Fleetline	GasSLX	# E.O.	Fleetline	GasSLX
471700000433	85099		90044025	83209	89414	90044978	85059		90045298	83128	
471700000436	85030		90044046	83123	89405	90044979	83113		90045299	85000	89436
471700000458	85014		90044071	85000	89436	90044980	85907		90045331	646155	
471700000459	85030		90044081	85000	89436	90044981	85000	89436	90045336	85014	
471700000460	85097		90044086	85000	89436	90044982	85000	89436	90045337	85911	
471700000461		89414	90044089	83124	89407	90044991	85000	89436	90045338	85060	
481700000483	85975		90044089C	83124	89407	90044992	85000	89436	90045381	83150	
481700000484	85974		90044095	83203	89436	90045000	85906	89407	90045384		89430
481700000485	85975		90044162	83128	89436	90045001	85323	89436	90045418	85916	
57639	85000	89436	90044448	85051		90045002	85906	89407	90045419		89405
57643	85013	89414	90044625	83125		90045003	85323	89436	90045420		89440
6025	83122	89406	90044626	83126	89430	90045019	85913		90045432	85321	
6026	83204		90044642	83127		90045028	85907		90045433	85916	
632155	646177		90044679	83122	89406	90045031	85968		90045455	85909	
665002	85004		90044680	83125		90045040	83130		90045466		89406
665003	85300	89419	90044681	83204		90045048	85905		90045471	83150	
665197	85051		90044682	83209	89414	90045049	85905		90045499	85974	
665454	85045		90044683	83122	89406	90045050	85914		90045500	85975	
665514	83127		90044684	83124	89407	90045053	85908		90045503	85975	
665969		89430	90044685	83128		90045054	85051		90045504	85030	
671921	85916		90044686	85051		90045068		89441	90045532	85030	
671922		89405	90044687	83125		90045075	85911		90045533	85099	
671923		89440	90044688	83122	89406	90045080	85912		90045534	85014	
671931	85916		90044769	83207	89407	90045083	85910		90045535	85097	
680234	85906	89407	90044770	83207	89407	90045084	85968		90045536		89414
680268	85323	89436	90044794	83127		90045096	85916		90045563	85014	
680645	85321		90044833	85052		90045099	85906	89407	90045564	83128	
90044001	85005	89430	90044834	85052		90045110	83121		90045568	85060	
90044008	85000	89436	90044868	85045		90045132	85909		90045572	85045	
90044011	85004		90044878	83635		90045138	85910		90045574	83130	
90044012	85006		90044907	83635		90045175	85916		90045575	85051	
90044016	85300	89419	90044915	83127		90045188	85910		90045576	83150	
90044017	83204		90044977	83115		90045207		89405	90045605	85109	

**Nota Importante:** Los intercambios deben utilizarse para cuestiones de almacenamiento únicamente. Cuando se identifiquen varios intercambios, consulte la sección de aplicaciones de este catálogo.

## Lista de Intercambios contra Competidores y Equipo Original

### SAF HOLLAND... cont

# E.O.	Fleetline	GasSLX	# E.O.	Fleetline	GasSLX	# E.O.	Fleetline	GasSLX	# E.O.	Fleetline	GasSLX
90045607	83150		AR-1141	83204		AR-1434	83203	89436	AR-718-C-HD	85000	89436
90045665	85029		AR-1141-C	83204		AR-1654	83209	89414	AR-781	83203	89436
90045666	83130		AR-1202	85300	89419	AR-1822	85304		AR-958	83207	89407
90045666	85051		AR-134-C	85005	89430	AR-2451	83203	89436	AR-995	85734	
90045669	85000		AR-1404	85301		AR-2598	83123	89405			
AR-1008	85006		AR-1425	85301		AR-718-C	83203	89436			

### SCANIA

# E.O.	Fleetline	GasSLX	# E.O.	Fleetline	GasSLX	# E.O.	Fleetline	GasSLX	# E.O.	Fleetline	GasSLX
489509	87020										

### SEAGRAVE FIRE APPARATUS LLC

# E.O.	Fleetline	GasSLX	# E.O.	Fleetline	GasSLX	# E.O.	Fleetline	GasSLX	# E.O.	Fleetline	GasSLX
680117	85300	89419	P0025500	85300	89419						

### SICARD

# E.O.	Fleetline	GasSLX	# E.O.	Fleetline	GasSLX	# E.O.	Fleetline	GasSLX	# E.O.	Fleetline	GasSLX
3166657	85700										

### SPARTAN MOTORS

# E.O.	Fleetline	GasSLX	# E.O.	Fleetline	GasSLX	# E.O.	Fleetline	GasSLX	# E.O.	Fleetline	GasSLX
0272-SS5	85712		47170000456	85959		78068	85304		B46-2151	85007	89412
0346-SS5	85013	89414	58913-009	85959		AS 4025B	85712				
0377-SS5	85029		59011	83214		B46-1594	85013	89414			
21310-01	85307		60665-025	85036		B46-1725	85029				

### SPRING VALLEY

# E.O.	Fleetline	GasSLX	# E.O.	Fleetline	GasSLX	# E.O.	Fleetline	GasSLX	# E.O.	Fleetline	GasSLX
632155	646177										

### STERLING TRUCK

# E.O.	Fleetline	GasSLX	# E.O.	Fleetline	GasSLX	# E.O.	Fleetline	GasSLX	# E.O.	Fleetline	GasSLX
10-12388-000	85920		C4HZ-18124-E	83309	89446	F5HZ-18124-A	83314		F6HT-18080-DA	83109	
10-12390-000	85920		C4TZ-18124-AB	83308		F5HZ-18124-B	83107		F6HT-18080-EA	85906	89407
10-13592-000	85959		D8HZ-18124-A	85301		F5HZ-18124-C	85063		F6HT-18080-FC	85013	89414
1210-0528	85904		E6HZ-18124-A	85301		F5HZ-18124-D	83125		F6HT-18124-JC	83200	
16-15770-000	85956		E6HZ-18124-D	85301		F5HZ-18125-A	85314	89425	F6HT-18124-KA	83200	
16-15817-000	85724	89443	E6HZ-18125-D	83215		F5HZ-18125-B	85001	89410	F6HZ-18124-A	85054	89438
16-18708-000	85724	89443	E7HZ-18124-A	85301		F6HT-18045-AA	85054	89438	F6HZ-18124-B	83308	
471700002809	85724	89443	E7XZ-18124-A	G63386		F6HT-18045-AC	85054	89438	F6HZ-18124-C	85055	89439
47902-28	85013	89414	E7XZ-18125-B	G63387		F6HT-18045-BC	85047	89435	F6HZ-18124-D	85055	89439
4C4Z-18124-N	85957		E9HZ-18124-A	83309	89446	F6HT-18045-CC	85055	89439	F6HZ-18124-E	85055	89439
4C4Z-18125-DA	85926		F0HZ-18124-B	85006		F6HT-18045-EB	85055	89439	F6HZ-18124-F	85055	89439
57241-2	83109		F1HZ-18124-A	83309	89446	F6HT-18045-EC	85055	89439	F6HZ-18124-G	85054	89438
58913-003	85932	89453	F1HZ-18124-B	83308		F6HT-18045-EB	85055	89439	F6HZ-18124-H	85054	89438
6803230200	85043		F1HZ-18124-D	85006	89401	F6HT-18045-EC	85030	89440	F6HZ-18124-I	85054	89438
6803230300	85006		F1HZ-18124-E	85006	89401	F6HT-18045-ED	85030	89440	F6HZ-18124-J	83200	
6803260000	83120		F1HZ-18124-F	85040		F6HT-18045-EE	85054	89438	F6HZ-18125-B	83109	
680611	85724	89443	F1HZ-18124-G	85040		F6HT-18045-EF	85054	89438	F6HZ-18125-D	85013	89414
6E7Z-18125-A	83146		F1HZ-18124-H	83308		F6HT-18045-EG	83200		F81A-18045-AGB	G63809	
90045099	85906	89407	F1HZ-18124-I	89402		F6HT-18045-EH	83200		SDA47170000440	85959	
AT-560	G63809		F2HZ-18124-A	85376		F6HT-18045-EI	83200		SDA471700002809	85724	89443
AX-267A	83309	89446	F2HZ-18124-B	85301		F6HT-18045-EJ	83200		XC45-18045-AA	83216	
AX-310	83215		F4HT-18080-AB	85314	89425	F6HT-18045-EK	83109		XC45-18080-BA	85724	89443
			F4HT-18080-BA	85001	89410	F6HT-18080-CA	85314	89425			

### STERLING TRUCK AMORTIGUADORES DE CABINA

# E.O.	Fleetline	GasSLX	# E.O.	Fleetline	GasSLX	# E.O.	Fleetline	GasSLX	# E.O.	Fleetline	GasSLX
1202-1043	83025		18-45067-000	83034		F6HZ-5K407-AB	83034		F8HT-5K407-AA	83033	
18-43504-000	83057		18-60768-000	83057		F6HZ-5K407-BA	83033				

### STOUGHTON TRAILERS INC.

# E.O.	Fleetline	GasSLX	# E.O.	Fleetline	GasSLX	# E.O.	Fleetline	GasSLX	# E.O.	Fleetline	GasSLX
HTA20001	83128	89436	NW90044162	83128	89436	NW90044978	85059		RT18165-01	85006	
HTA20002	85000	89436	NW90044448	85051		NW90044979	83113				

**Nota Importante:** Los intercambios deben utilizarse para cuestiones de almacenamiento únicamente. Cuando se identifiquen varios intercambios, consulte la sección de aplicaciones de este catálogo.

## Lista de Intercambios contra Competidores y Equipo Original

### STOUGHTON TRAILERS INC.... cont

#### SUSPENSIONS INC.

# E.O.	Fleetline	GasSLX	# E.O.	Fleetline	GasSLX	# E.O.	Fleetline	GasSLX	# E.O.	Fleetline	GasSLX
200188	646155										

#### SUSPENSYS

# E.O.	Fleetline	GasSLX	# E.O.	Fleetline	GasSLX	# E.O.	Fleetline	GasSLX	# E.O.	Fleetline	GasSLX
218004872	85737										

#### TEREX CORPORATION

# E.O.	Fleetline	GasSLX	# E.O.	Fleetline	GasSLX	# E.O.	Fleetline	GasSLX	# E.O.	Fleetline	GasSLX
12111	646155										

#### THE BINKLEY COMPANY

# E.O.	Fleetline	GasSLX	# E.O.	Fleetline	GasSLX	# E.O.	Fleetline	GasSLX	# E.O.	Fleetline	GasSLX
16965	85006		6898	83125							

#### THOMAS SCHOOL BUS

# E.O.	Fleetline	GasSLX	# E.O.	Fleetline	GasSLX	# E.O.	Fleetline	GasSLX	# E.O.	Fleetline	GasSLX
10-13634-000	85918	89449	61300222	85091		614974	85304		8C24-18080-DB	83178	
128745	83102		61300223	85091		63-0001	85713		8C2Z-18124-D	83177	
16-15817-000	85724	89443	61300224	85918	89449	651442	83102		8C2Z-18125-D	83178	
16-18708-000	85724	89443	61300240	85918	89449	659287	83102		90045504	85030	
16-18713-000	85122		61300285	83102		680-323-0300	85006		A-4890	85712	
16-19138-000	85058	89431	6130029	85712		680-326-0000	83120		ASH-1136	83178	
300-0614966	85307		61310101	85736		680010	85304		ASH-1154	83177	
471700003070	85122		61310102	85308	89422	680054	85307		AT-163G	83177	
471700131545	85006		61310103	85308	89422	680088	85713		AT-164G	83178	
60998-001	85006		61310104	85713		680102	85712		GBL654725	83120	
60998-003	85006		61310232	85000	89436	70445	85091		GBL665538	85006	
6130-0114		89437	61310434	85724	89443	728802	85736				
61300112	83613		61310478	85724	89443	87002	85736				
61300219	85091		614966	85307		8C24-18045-DA	83177				

#### THOR MOTOR COACH

# E.O.	Fleetline	GasSLX	# E.O.	Fleetline	GasSLX	# E.O.	Fleetline	GasSLX	# E.O.	Fleetline	GasSLX
141700131809	85029		16-16736-000	85029		16-16873-000	85029		16-18103-000	85900	
141700131810	83160		16-16737-000	83160		16-16874-000	83160		481700000493	85900	

#### TIMBREN INDUSTRIES

# E.O.	Fleetline	GasSLX	# E.O.	Fleetline	GasSLX	# E.O.	Fleetline	GasSLX	# E.O.	Fleetline	GasSLX
665804	85939										

#### TRAILMOBILE CANADA CORP.

# E.O.	Fleetline	GasSLX	# E.O.	Fleetline	GasSLX	# E.O.	Fleetline	GasSLX	# E.O.	Fleetline	GasSLX
43-4-235	85051		43-6-028	85000	89436	43-8-014	85013	89414	90044978	85059	
43-4-236	85029		43-6-118	85000	89436	43-8-015	85006		90044979	83113	
43-4-237	85000	89436	43-6-137	85006		43-8-022	83225		90044992	85000	89436
43-4-239	83207	89407	43-6-158	85013	89414	43-8-031	85029		90045054	85051	
43-4-241	85006		43-6-164	83207	89407	90044089	83124	89407	A-2212	85029	
43-4-277	85000	89436	43-8-002	83209	89414	90044625	83125				
43-4-278	85059		43-8-011	83207	89407	90044642	83127				
43-4-279	83204		43-8-013	85000	89436	90044977	83115				

#### TRANSPORTATION MFG. CORP

# E.O.	Fleetline	GasSLX	# E.O.	Fleetline	GasSLX	# E.O.	Fleetline	GasSLX	# E.O.	Fleetline	GasSLX
12-05-6000	85711		12J-5-3	85313		12TA-01-13	85303	89422	680350	85710	
12-05-6002	85339		12J-5-4	85312		22012079	85701		680470	85713	
12-05-6033	85339		12J-5-6	85313		22024673	85710		695117	85701	
12B-5-1	85735		12J-5-9	85700		22045526	85702		695273	85710	
12G-5-1	85700		12L-5-69	85700		22046485	85710		695279	85710	
12J-5-10	85733		12L-5-70	85700		22052014	85702		74410	85701	
12J-5-11	85313		12L-5-99	85339		4975515	85701		G1011822	85702	
12J-5-2	85312		12T-1-13	85303	89422	680349	85702		G1101590	85713	

**Nota Importante:** Los intercambios deben utilizarse para cuestiones de almacenamiento únicamente. Cuando se identifiquen varios intercambios, consulte la sección de aplicaciones de este catálogo.

# Lista de Intercambios contra Competidores y Equipo Original

## TRUCKMASTER

Truckmaster	Fleetline	GasSLX	Truckmaster	Fleetline	GasSLX	Truckmaster	Fleetline	GasSLX	Truckmaster	Fleetline	GasSLX
665632	85013	89414	665930	85001	89410	680240	85302	89420	680303	85007	89412
665633	85033	89427	665931	83312	89409	680241	85311	89424	680348	85012	89413
665783	83123	89405	665932	85012	89413	680242	85308	89422	680385	85311	89424
665784	83122	89406	665950	85902		680243	85001	89410	680425	85320	89429
665785	83137		671052	85070	89459	680253	85314	89425	680435	85033	89427
665844	85069	89455	671654	85936	89456	680261	85062	89408	680473	85319	89428
665918	85900		671699	85937		680279	83209	89414	680586	85311	89424
665926	85047	89435	671794	85067	89451	680280	85906	89407	680601	85012	89413
665927	85901		680237	85303	89422	680281	85003	89411			
665928	85062	89408	680239	85310	89423	680283	83353				

## TUTHILL TECHNOLOGIES

# E.O.	Fleetline	GasSLX	# E.O.	Fleetline	GasSLX	# E.O.	Fleetline	GasSLX	# E.O.	Fleetline	GasSLX
1085	83214		17358-01	83126	89430	19495-01	83126	89440	24392-01	85051	
12885-01	85300	89419	17403-01	83122	89406	19623-01	83123	89405	2697	85712	
12885-03	85300	89419	17408-01	85005	89430	19824-01	85006		66502	646155	
12887-01	85013	89414	17794-01	83215		20125-01	85030	89440	680162	85300	89419
12887-02	85013	89414	18146-01	85313		20126-01		89440	702135-01	85045	
14954-01	83217		18163-01	83207	89407	20129-01	85007	89412	702136-01	85052	
16230-01	85702		18164-01	83122	89406	20960-01	83204		702209-01	85014	
16725-01	83221		18165-01	85006		21497-01	85005	89430	OE12425	83214	
16824-01	85006		18166-01	85704		23524-01	85738				
17142-01	85001	89410	18286-01		89414	23553-01	85938				
17146-01	83209	89414	18800-01	83203	89436	23614-01	85717				

## TWIN COACH

# E.O.	Fleetline	GasSLX	# E.O.	Fleetline	GasSLX	# E.O.	Fleetline	GasSLX	# E.O.	Fleetline	GasSLX
90044089	83124	89407	90044162	83128	89436	AR-958	83207	89407			
90044089C	83124	89407	AR-718-C-HD	85000	89436						

## UNITED MANUFACTURING

# E.O.	Fleetline	GasSLX	# E.O.	Fleetline	GasSLX	# E.O.	Fleetline	GasSLX	# E.O.	Fleetline	GasSLX
K-96-41	85304										

## UNIVERSAL COACH

# E.O.	Fleetline	GasSLX	# E.O.	Fleetline	GasSLX	# E.O.	Fleetline	GasSLX	# E.O.	Fleetline	GasSLX
12-05-1199	85729		680777	85729							

## UPS TRUCK

# E.O.	Fleetline	GasSLX	# E.O.	Fleetline	GasSLX	# E.O.	Fleetline	GasSLX	# E.O.	Fleetline	GasSLX
P117099	83120		P117146	83118							

## VAN HOOL

# E.O.	Fleetline	GasSLX	# E.O.	Fleetline	GasSLX	# E.O.	Fleetline	GasSLX	# E.O.	Fleetline	GasSLX
10685703	695406		6243-14040	85708		665562	85708		90-2291	695406	
6243-13790	85708		624314570	695406		665563	85708				

## VARIOS

# E.O.	Fleetline	GasSLX	# E.O.	Fleetline	GasSLX	# E.O.	Fleetline	GasSLX	# E.O.	Fleetline	GasSLX
SC-2920	83176										

## VOLKSWAGEN

# E.O.	Fleetline	GasSLX	# E.O.	Fleetline	GasSLX	# E.O.	Fleetline	GasSLX	# E.O.	Fleetline	GasSLX
2P0413031C	85076		2RF513031	85074		2TJ413031	85948		TAR413031	85948	
2P0513031	85077		2S2413031	85949		2Z0413031A	85075		TAR513031	85951	
2R0413031	85073		2T0413031	85947		2Z0413031C	85945		TAU413031	85949	
2R2413031	85073		2T0413031A	85949		2Z0513031B	85946		TGG413031	85940	
2R2513031	85074		2T0413031B	85941		TAL413031	85949		TGG513031	85942	
2RE413031	85073		2T0513031A	85950		TAL513031	85943		TJG513031B	85944	
2RF413031	85073		2TB513031B	85946		TAP513031	85074				

## VOLKSWAGEN AMORTIGUADORES DE CABINA

# E.O.	Fleetline	GasSLX	# E.O.	Fleetline	GasSLX	# E.O.	Fleetline	GasSLX	# E.O.	Fleetline	GasSLX
2R0899515	83043		TJG899515	83043							

**Nota Importante:** Los intercambios deben utilizarse para cuestiones de almacenamiento únicamente. Cuando se identifiquen varios intercambios, consulte la sección de aplicaciones de este catálogo.

## Lista de Intercambios contra Competidores y Equipo Original

### VOLVO

# E.O.	Fleetline	GasSLX	# E.O.	Fleetline	GasSLX	# E.O.	Fleetline	GasSLX	# E.O.	Fleetline	GasSLX
02-7005976	83400		20433426	85081		3199972	85320	89429	3919569	85052	
02-7005977	83400		20433427	85065		3199973	85722		3919570	83128	
03-1106460	85005	89430	20434880	85081		3199974	85712		3919571	83635	
1-0200-32-888-1	83104		20485633	85933	89454	3199975	85700		3919572	83130	
1091347	83125		20513881	85061	89450	3199976	85711		3919573	83123	89405
1091348	83122	89406	20540056	83165		3199977	85711		3919574	85006	89401
1091349	83204		20551628	85066	89448	3199978	85712		3919575	83120	
1091350	83207	89407	20782199	85072		3199979	85702		3919582	83215	
1091351	83209	89414	20863239	85080		3199980	85310	89423	3919583	83100	
1091353	83215		21137330	85933	89454	3199982	85703		3919584	83353	
1091354	83216		21436086	85098		3199983	85704		3919585	83209	89414
1091355	83217		21462378	85088		3199984	85314	89425	3919586	83100	
1091357	83219		21462380	85088		3199985	85723		3919587	83105	
1091358	83456	89447	22012065	85304		3199986	85318		3919588	83216	
1091359	83123	89405	22046483	85304		3199987	85705		3919589	85026	89417
1091360	83303		22052336	85304		3199988	85311	89424	3919590	85042	
1091361	83304		3031626	85089		3199989	85709		3919591	G63616	
1091362	83309	89446	3036162	85089		3199990	85003	89411	3919592	85024	89416
1091363	83221		3037213	83165		3199991	85708		3919593	83242	
1091364	83312	89409	3037213	85094		3199992	85733		3919594	85003	89411
1091365	83400		3082284	83400		3199993	85712		3919596	G63484	
1091366	83401		3092842	85061	89450	3199994	85308	89422	3919598	83312	89409
1091367	85000	89436	3130140	85315		35901-0001	83209	89414	3919900	85012	89413
1091368	85003	89411	3171696	85307		35901-0003	85301		3919901	83103	
1091370	85006		3172948	85303	89422	35901-0004	83219		3919902	83126	89430
1091371	85300	89419	3199937	85316	89426	35901-0005	83219		3919903	83216	
1091372	85301		3199938	85030	89432	35901-0008	85060		3919904	G63183	
1091373	85302	89420	3199939	85058	89431	35901-0011	83123	89405	3919906	83308	
1091374	85303	89422	3199940	85005	89430	35901-0017	83314		3919907	83309	89446
1091375	85304		3199941	85006		35901-0022	83635		3919908	83104	
1091376	85305		3199942		89402	35901-3201	85024	89416	3919909	G63605	
1091377	85307		3199943	85012	89413	35901-3406	85305		3919910	83221	
1091378	85308	89422	3199944	85006		35901-3409	85304		3919911	83124	89407
1091379	85310	89423	3199945	85027	89418	35901-3410	85307		3919912	83215	
1091384	85735		3199946	85033	89427	35901-3413	85006		3919913	83203	89436
1093100	85027	89418	3199947	85013	89414	35901-3420	85303	89422	3919914	83209	89414
1093174	83353		3199948	85311	89424	37001-5	83401		3919915	83127	
1093176	85024	89416	3199949	85310	89423	37301-0001	85013	89414	3919916	83126	89430
1093177	85025		3199950	85023	89415	37301-0008	83400		3919917	83125	
1093178	85026	89417	3199951	85024	89416	37301-0016	85026	89417	3919918	83401	
1093180	85030	89440	3199952	85736		37301-0018	85005	89430	3919919	G63625	
131912	85121		3199953	85319	89428	37301-0021	85026	89417	3919920	83303	
13193027	85121		3199954	85003	89411	37301-3201	85027	89418	3919921	83123	89405
14170000373	85061	89450	3199955	85300	89419	37301-3202	85026	89417	3919922	83318	
14170000901	83165		3199956	85036	89405	3915917	85319	89428	3919923	83301	
141700005838	85098		3199957	83122	89406	3915947	85001	89410	3919924	83456	89447
141700125243	85089		3199959	85323	89436	3915948	85311	89424	3919925	83317	
141700125275	83165		3199960	85322		3916352	85013	89414	3919926	G63403	
1505190	85722		3199961	85307		3919055	85007	89412	3919927	83101	
1590439	83104		3199962	85314	89425	3919056	83203	89436	3919928	83225	
1591501	85722		3199963	85315		3919057	83225		3919930	83353	
1591735	83104		3199965	85736		3919526	83314		3919931	83126	89430
1593843	83215		3199966	85303	89422	3919561	85314	89425	3919932	85062	89408
1716824	85304		3199967	85302	89420	3919565	83103		3919933	85001	89410
20433424	85061	89450	3199968	85308	89422	3919567	83613		3919934	85320	89429
20433425	85066	89448	3199970	85701		3919568	83636		3919935	85026	89417

**Nota Importante:** Los intercambios deben utilizarse para cuestiones de almacenamiento únicamente. Cuando se identifiquen varios intercambios, consulte la sección de aplicaciones de este catálogo.

## Lista de Intercambios contra Competidores y Equipo Original

### VOLVO... cont

# E.O.	Fleetline	GasSLX	# E.O.	Fleetline	GasSLX	# E.O.	Fleetline	GasSLX	# E.O.	Fleetline	GasSLX
3919936	83207	89407	3919975	85700		3953643	85040		64838-001	85933	89454
3919937	85316	89426	3919976	85033	89427	3972662	85976		64838-002	85933	89454
3919938	85030	89432	3919977	85033	89427	47170000443	85066	89448	64838-003	85933	89454
3919939	85058	89431	3919978	85702		471700002627	85066	89448	66010-0016	85025	
3919940	85005	89430	3919979	85702		471700003832	85933	89454	665410	85027	89418
3919941	85006		3919980	85702		471700006038	85088		665539	85026	89417
3919942	89402		3919981	85701		471700006040	85088		665607	85047	89435
3919943	85012	89413	3919982	85703		471700125245	85089		665623	85046	89434
3919944	85036		3919983	85704		471700131256	85065		665739	85047	89435
3919945	85027	89418	3919984	85700		471700131258	85081		668302	83216	
3919946	85033	89427	3919985	85723		471700131920	85933	89454	676081	83401	
3919947	85013	89414	3919987	85706		471700131921	85933	89454	676082	83401	
3919948	85311	89424	3919988	85311	89424	47902-24	83121		6771501	85040	
3919949	85310	89423	3919989	85709		48170000801	85381		6772218	85040	
3919950	83219		3919990	85003	89411	481700125768	85121		6775411	85040	
3919951	83309	89416	3919991	85708		481700131912	85121		6775412	85040	
3919952	85736		3919992	85733		494-660	83219		6790756	83215	
3919953	85319	89428	3919993	85712		4940640	83216		6794358	85040	
3919954	85003	89411	3919994	85310	89423	4975479	83400		6857668	83105	
3919955	85300	89419	3945806		89417	4975480	83400		6876828	83105	
3919956	85036	89405	3945807		89416	4975549	83216		70042	85302	89420
3919957	83122	89406	3945808		89407	530596	85308	89422	70321695	85381	
3919958	85046	89434	3945809		89410	5322338	83214		8026658	85046	89434
3919959	85000	89436	3945810		89420	5513989	83216		8056892	85023	89415
3919960	85322		3945811		89409	5531435	85307		8060026	85065	
3919961	85302	89420	3945812		89423	5531436	85307		8065787	85026	89417
3919962	85700		3945813		89428	5531437	85307		8071524	85024	89416
3919963	85730		3945814		89424	5534430	85303	89422	8073212	85065	
3919964	85304		3945815		89406	5534447	85303	89422	8075257	85065	
3919964	85716		3945816		89430	5549899	83207	89407	8075287	85065	
3919965	85702		3945817		89422	5549925	85304		8077874-P01	85047	89435
3919966	85736		3945818		89415	5554959	83401		8078195	85061	89450
3919967	85302	89420	3945819		89411	57241-3	83112		8083872	85978	
3919968	85736		3945820		89413	60657-007	85072		8086053	85047	89435
3919970	85701		3945821		89419	60675-001	85978		8086651	85066	89448
3919972	85320	89429	3946210	83103		629398	85307		8169859	85047	89435
3919973	85956		3946219	83400		629501	85307		8174749	85906	89407
3919974	85712		3949241	85061	89450	646220	85734		SDA471700131258	85081	

### VOLVO AMORTIGUADORES DE CABINA

# E.O.	Fleetline	GasSLX	# E.O.	Fleetline	GasSLX	# E.O.	Fleetline	GasSLX	# E.O.	Fleetline	GasSLX
1201-0012	83023		20496217	83029		21391412	83048		8078547	83029	
1202-0012	83023		20704334	83048		635869	83004		8162662	83004	
1202-0022	83046		20721254	83048		66010-0007	83004		8168617	83030	
1202-0032	83016		20874147	83050		66010-0008	83004				
20496215	83048		21368413	83048		8078546	83028				

### WABASH NATIONAL

# E.O.	Fleetline	GasSLX	# E.O.	Fleetline	GasSLX	# E.O.	Fleetline	GasSLX	# E.O.	Fleetline	GasSLX
202447	85919		FRUJUCE1295-901	85300	89419	HENS-24088	85000	89436	NEW900-44-978	85059	
203447	85919		FRUJUCE2983-1	85322		NEW900-44-089	83124	89407	NEW900-44-979	83113	
DANSR1VJ100	85078		FRUUCF8339-1	85321		NEW900-44-162	83128	89436	NEW900-45-040	83130	
FLL83203-071	83203	89436	HENS-20001	83128	89436	NEW900-44-625	83125		NEW900-45-054	85051	
FLL83207-071	83207	89407	HENS-20002	85000	89436	NEW900-44-626	83126	89430	NEW900-45-298	83128	
FLL85000-071	85000	89436	HENS-20126	85323	89436	NEW900-44-642	83127		NEW900-45-299	85000	89436
FLL85030-071	85030	89440	HENS-21292	85052		NEW900-44-794	83127				
FRUJUCE1295-1	85300	89419	HENS-23566	85000	89436	NEW900-44-868	85045				

**Nota Importante:** Los intercambios deben utilizarse para cuestiones de almacenamiento únicamente. Cuando se identifiquen varios intercambios, consulte la sección de aplicaciones de este catálogo.



## Lista de Intercambios contra Competidores y Equipo Original

### WATSON & CHALIN MFG. INC.

# E.O.	Fleetline	GasSLX	# E.O.	Fleetline	GasSLX	# E.O.	Fleetline	GasSLX	# E.O.	Fleetline	GasSLX
10147	83203	89436	17079	85300	89419	17430	85321		665770	85064	
10147HD	85000	89436	17186	85323	89436	17474	85009		665862	85000	89436
10148	83204		17186-01	85323	89436	19036	85934		680547	85323	89436
10634	G63357		17218	85029		19603	85939		680584	85938	
11418	646155		17297	85064		3946219	83400		680714	85934	
11604	83125		17300	85052		665724	85000	89436	727603	83203	89436
11724	83123	89405	17306	85938		665727	85005	89430	727604	83204	
12128	85005	89430	17317	85344		665728	85060				
17069	632147		17382	85014		665769	85052				

### WESTERN STAR

# E.O.	Fleetline	GasSLX	# E.O.	Fleetline	GasSLX	# E.O.	Fleetline	GasSLX	# E.O.	Fleetline	GasSLX
02-7005976	83400		35901-3409	85304		37390-4403	85053	89442	615016	83401	
02-7005977	83400		35901-3410	85307		471700006269	85932	89453	665682	85053	89442
04-9041375	85315		35901-3413	85006		47902-13	83122	89406	676081	83401	
10-13809-000	85958		35901-3420	85303	89422	47902-24	83121		676082	83401	
1011839	83216		35901-4403	85060		47902-8	83122	89406	90044025	83209	89414
16-15770-000	85956		37301-3401	85053	89442	57241-1	83111		90044907	83635	
16-18706-000	85331		37301-3404	85053	89442	57252	85308	89422	90045099	85906	89407
16-18708-000	85724	89443	37301-3405	85053	89442	57905-1	85976		CP-5222	85315	
28R010	83216		37301-3409	85053	89442	57905-2	85006		SDA471700003920	85958	
35066-4413	83122	89406	37301-3412	85053	89442	58913-003	85932	89453	SDA481700125969	85956	
35901-0001	83209	89414	37390-4401	85053	89442	58913-012	85932	89453			
35901-3406	85305		37390-4402	85053	89442	60675-002	85979				

### WESTERN STAR AMORTIGUADORES DE CABINA

# E.O.	Fleetline	GasSLX	# E.O.	Fleetline	GasSLX	# E.O.	Fleetline	GasSLX	# E.O.	Fleetline	GasSLX
1201-0012	83023		18-60772-000	83026		66010-3404	83022		81-4903003500	83026	
1201-0022	83046		18-60773-000	83027		66010-3405	83026		814903003501	83027	
1202-0012	83023		617547	83022		66010-3406	83027				
1202-0022	83046		654846	83027		66010-3407	83065				
1202-0032	83016		654916	83026		725470	83010				

### WESTERN UNIT "STABILAIR" SUSPENSION

# E.O.	Fleetline	GasSLX	# E.O.	Fleetline	GasSLX	# E.O.	Fleetline	GasSLX	# E.O.	Fleetline	GasSLX
101030	85307		4939967	85308	89422	80600	85300	89419			
101364	85305		80370	85304							

### WESTPORT AXLE CORP

# E.O.	Fleetline	GasSLX	# E.O.	Fleetline	GasSLX	# E.O.	Fleetline	GasSLX	# E.O.	Fleetline	GasSLX
143699-0185	646177		646124	646177							

### WINNEBAGO

# E.O.	Fleetline	GasSLX	# E.O.	Fleetline	GasSLX	# E.O.	Fleetline	GasSLX	# E.O.	Fleetline	GasSLX
141700131809	85029		16-16736-000	85029		16-16873-000	85029		16-18103-000	85900	
141700131810	83160		16-16737-000	83160		16-16874-000	83160		481700000493	85900	

### WORKHORSE

# E.O.	Fleetline	GasSLX	# E.O.	Fleetline	GasSLX	# E.O.	Fleetline	GasSLX	# E.O.	Fleetline	GasSLX
659222	83171		680672	85919		W0007363	83171				
659223	G63866		7805-X-1012	85919		W0007365	G63866				

**Nota Importante:** Los intercambios deben utilizarse para cuestiones de almacenamiento únicamente. Cuando se identifiquen varios intercambios, consulte la sección de aplicaciones de este catálogo.

# CÓMO ESCOGER EL MEJOR AMORTIGUADOR PARA SU CAMIÓN

**1ER PASO:** Mida el diámetro de la polvera y del cilindro para determinar la serie.

## DIMENSIONES EXTERNAS

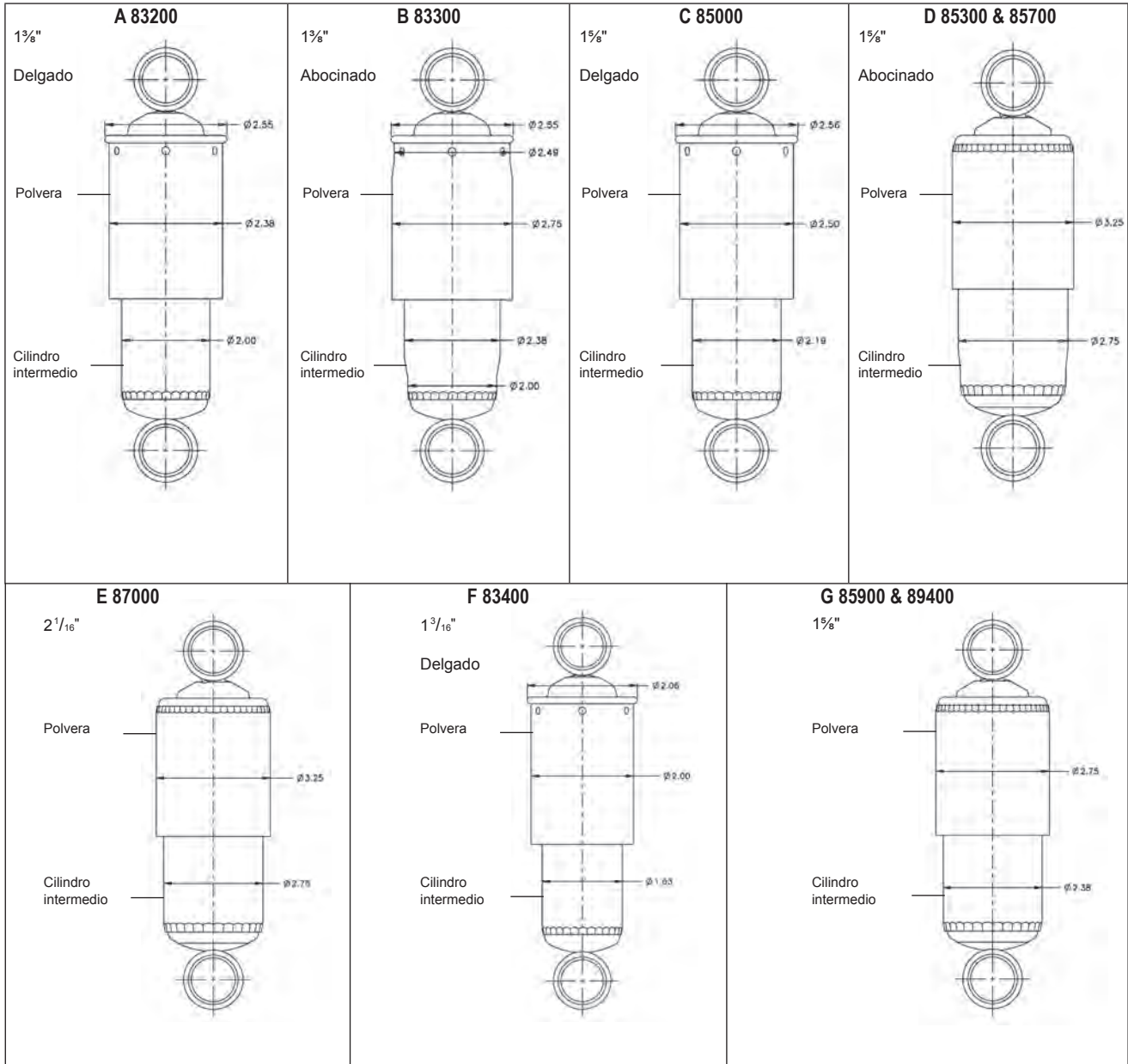

# CÓMO ESCOGER EL MEJOR AMORTIGUADOR PARA SU CAMIÓN

**2º PASO:** Identifique el tipo de montaje. Mida la longitud totalmente extendida y totalmente comprimida, en los puntos indicados para cada tipo de montaje.

## CÓMO MEDIR LAS LONGITUDES EXTENDIDA Y COMPRIMIDA DE LOS AMORTIGUADORES

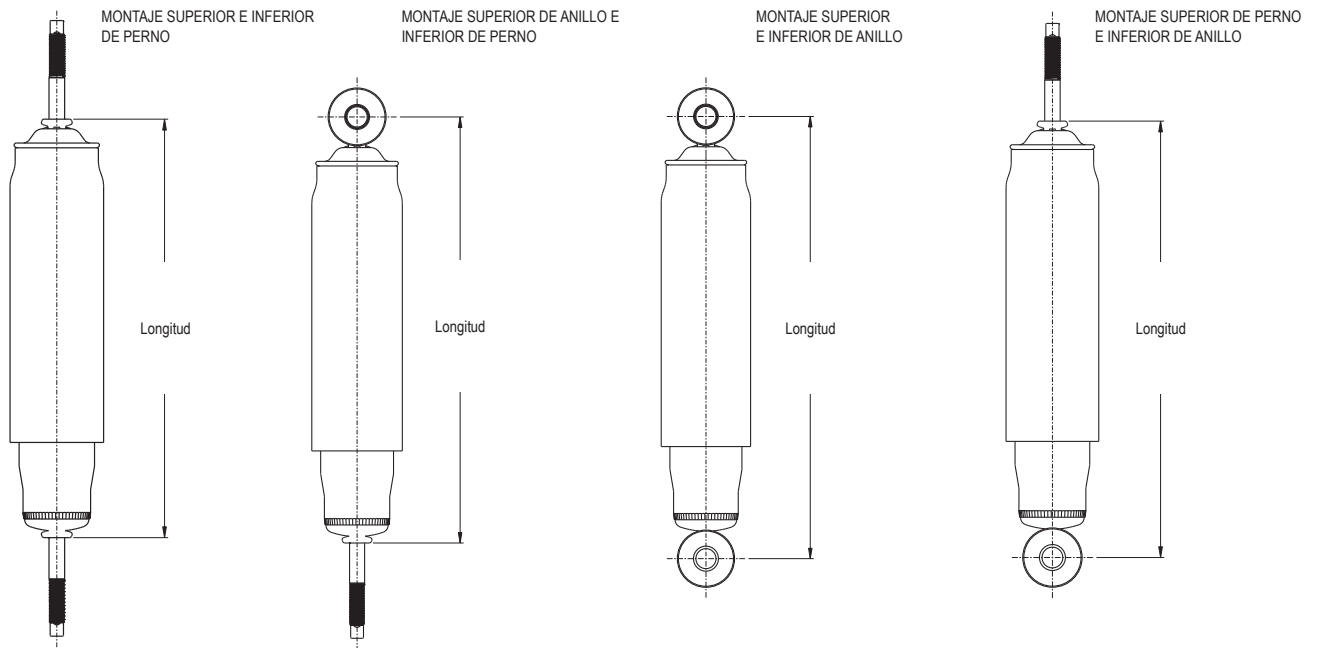

### INSTRUCCIONES:

1. Usando los puntos de medida adecuados como se menciona arriba, encuentre el amortiguador más cercano en la lista por incrementos de la longitud extendida.
2. Identifique el montaje adecuado por medio de los códigos de montaje y compare estas especificaciones, midiendo cuidadosamente las dimensiones del montaje (superior e inferior) del amortiguador por reemplazar.
3. Note cuidadosamente los siguientes requerimientos:
  - a. **Polvera** – Este componente debe estar presente en el amortiguador por reemplazar. El ambiente de trabajo del amortiguador hacen a la polvera necesaria para proteger la barra del pistón y extender la vida del producto.
  - b. **Corte hidráulico y tope de compresión** - Ponga especial atención a las siguientes especificaciones – desviación de longitudes requeridas no debe exceder + 1/4". Estos diseños de amortiguadores se encuentran identificados al pie de página para fácil referencia.

**Nota:** La garantía NO aplica si los amortiguadores fueron instalados en aplicaciones no recomendadas en nuestro catálogo.

# CÓMO ESCOGER EL MEJOR AMORTIGUADOR PARA SU CAMIÓN

**3ER PASO:** Mida los diámetros, anchuras y longitudes de los montajes. Consulte las siguientes tablas para determinar equivalencia en el código de montaje

## CÓDIGO DE MONTAJE «EB» ANILLO Y BUJE

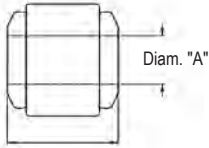
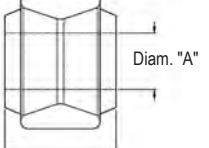
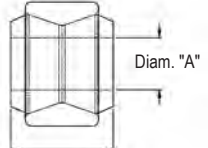
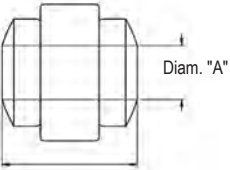
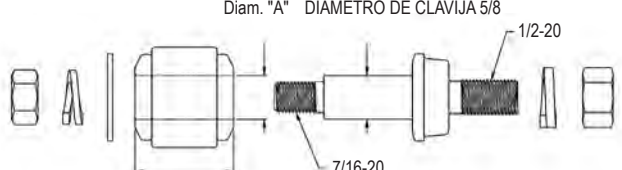
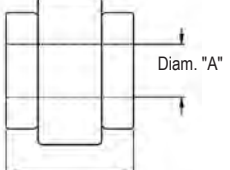
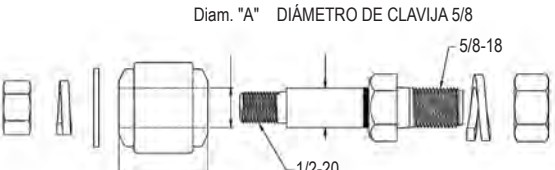
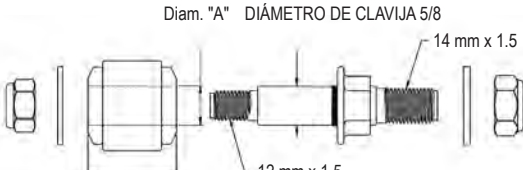
<p><b>EB1</b></p>  <p>Diam. "A"</p> <p>LONGITUD LIBRE "B" LONGITUD COMPRIMIDA "C"</p>	<p><b>EB2</b></p>  <p>Diam. "A"</p> <p>LONGITUD LIBRE "B" LONGITUD COMPRIMIDA "C"</p>	<p><b>EB3</b></p>  <p>Diam. "A"</p> <p>LONGITUD LIBRE "B" LONGITUD COMPRIMIDA "C"</p>	
<p><b>EB4</b></p>  <p>Diam. "A"</p> <p>LONGITUD LIBRE "B" LONGITUD COMPRIMIDA "C"</p>	<p><b>EB6</b></p>  <p>Diam. "A" DIÁMETRO DE CLAVIJA 5/8</p> <p>1/2-20</p> <p>7/16-20</p> <p>LONGITUD LIBRE "B" LONGITUD COMPRIMIDA "C"</p>		
<p><b>EB5</b></p>  <p>Diam. "A"</p> <p>LONGITUD LIBRE "B" LONGITUD COMPRIMIDA "C"</p>	<p><b>EB7</b></p>  <p>Diam. "A" DIÁMETRO DE CLAVIJA 5/8</p> <p>5/8-18</p> <p>1/2-20</p> <p>LONGITUD LIBRE "B" LONGITUD COMPRIMIDA "C"</p>		
<p><b>EB8</b></p>  <p>Diam. "A" DIÁMETRO DE CLAVIJA 5/8</p> <p>14 mm x 1.5</p> <p>12 mm x 1.5</p> <p>LONGITUD LIBRE "B" LONGITUD COMPRIMIDA "C"</p>			

# CÓMO ESCOGER EL MEJOR AMORTIGUADOR PARA SU CAMIÓN

## CÓDIGO DE MONTAJE «EB» ANILLO Y BUJE

Código de montaje	Diámetro "A"	B Longitud libre	C Longitud comprimida	Diámetro de clavija de montaje del vehículo
EB1	5/8	1.44	1.31	5/8
EB2	3/4	1.75	1.50	3/4
EB3	1.00	1.91	1.75	1.00
EB4	11/16	1.72	1.55	11/16
EB5	5/8	1.51	1.25	5/8
EB6	5/8	1.44	1.31	Perno proveído con el amortiguador para orificio de montaje de 1/2" de diámetro.
EB7	5/8	1.44	1.31	Perno proveído con el amortiguador para orificio de montaje de 5/8" de diámetro.
EB8	5/8	1.44	1.31	Perno proveído con el amortiguador para orificio de montaje de 14 mm de diámetro.
EB9	1	1.75	--	1
EB10	1.00	1.00	--	1.00
EB11	3/8	0.83	--	3/8
EB12	10MM	1.18	--	10MM
EB13	12MM	1.03	--	12MM
EB14	15MM	1.41	--	15MM
EB15	15MM	1.76	--	15MM
EB16	16MM	1.5	--	16MM
EB17	17MM	1.18	--	17MM
EB18	19MM	1.65	--	19MM
EB19	20MM	1.75	--	20MM
EB20	45/64	1.05	--	45/64
EB21	45/64	1.39	--	45/64

## CÓDIGO DE MONTAJE «BP» ANILLO Y BUJE CON CLAVIJA TIPO BARRA

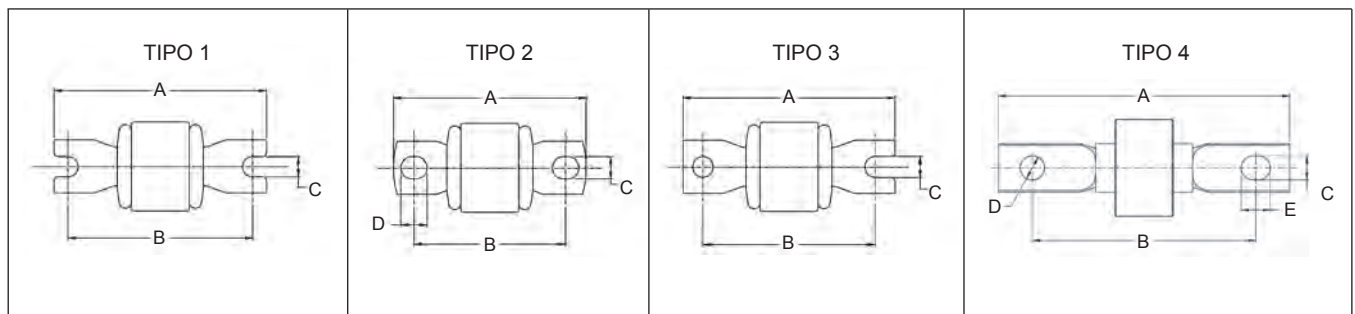

Código de montaje	TIPO	A	B	C	D	E	Código de montaje	TIPO	A	B	C	D	E
BP1	1	2.72	2.20	0.33	--	--	BP17	1	3.11	2.61	0.33	--	--
BP2	1	3.59	3.12	0.32	--	--	BP18	1	3.75	3.14	0.39	--	--
BP3	1	2.82	2.38	0.33	--	--	BP19	1	3.19	2.62	0.33	--	--
BP4	1	3.19	2.38	0.33	--	--	BP20	1	3.59	3.12	0.33	--	--
BP5	1	3.19	2.75	0.33	--	--	BP26	3	3.06	2.37	0.26	--	--
BP6	1	4.25	3.62	0.33	--	--	BP27	2	4.00	2.95	0.52	0.50	--
BP7	2	3.13	2.50	0.35	0.42	--	BP29	2	4.00	2.95	0.37	0.49	--
BP8	2	3.50	2.87	0.35	0.42	--	BP30	1	3.00	2.25	0.34	--	--
BP9	1	3.38	2.60	0.35	0.57	--	BP31	3	3.50	2.87	0.35	--	--
BP10	2	3.5	2.74	0.50	0.50	--	BP32	2	3.45	2.83	0.42	--	--
BP11	1	2.96	2.52	0.33	--	--	BP33	2	4.44	3.62	0.39	0.47	--
BP12	1	3.75	3.14	0.33	--	--	BP34	1	3.81	2.99	0.41	--	--
BP13	1	3.45	3.00	0.33	--	--	BP35	2	3.53	2.73	0.38	0.38	--
BP14	2	3.43	2.87	0.45	--	--	BP36	2	4.72	3.38	0.52	0.52	--
BP15	4	4.56	3.62	0.39	0.47	0.39							

# CÓMO ESCOGER EL MEJOR AMORTIGUADOR PARA SU CAMIÓN

## CÓDIGO DE MONTAJE «ES» Y «CB» ANILLO Y BUJE CON CAMISA DE ACERO

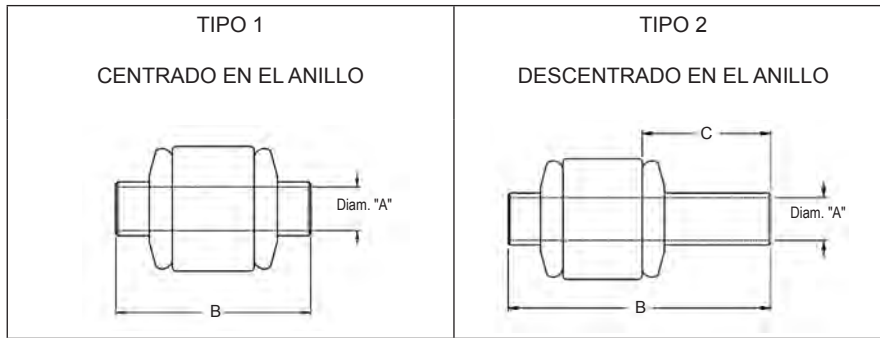

Código de montaje	TIPO	DIMENSIÓN			Código de montaje	TIPO	DIMENSIÓN			Código de montaje	TIPO	DIMENSIÓN		
		A	B	C			A	B	C			A	B	C
ES1	1	10MM	1.25	--	ES56	1	14MM	1.58	--	ES121	1	3/4	2.06	--
ES2	1	10MM	1.42	--	ES57	1	10MM	1.03	--	ES123	1	16MM	1.57	--
ES3	1	10MM	1.56	--	ES58	1	14MM	2.13	--	ES126	1	1/2	2.44	--
ES4	2	1/2	2.20	0.77	ES59	1	15MM	1.56	--	ES128	1	1/2	1.66	--
ES5	1	10MM	2.07	--	ES60	1	14MM	1.26	--	ES130	1	1/2	1.56	--
ES6	1	10MM	2.35	--	ES61	1	12MM	1.76	--	ES133	1	12MM	1.93	--
ES7	1	9/16	1.25	--	ES62	1	12MM	0.98	--	ES136	1	5/8	1.75	--
ES8	1	7/16	1.25	--	ES63	1	15MM	2.28	--	ES137	1	1/2	1.73	--
ES9	1	7/16	1.31	--	ES64	1	16MM	1.25	--	ES138	1	5/8	1.70	--
ES10	1	7/16	1.38	--	ES65	1	12MM	1.38	--	ES139	1	12MM	1.35	--
ES11	1	7/16	1.50	--	ES66	1	16MM	1.38	--	ES141	1	12MM	1.61	--
ES12	1	7/16	1.62	--	ES67	1	16MM	1.56	--	ES142	1	16MM	1.43	--
ES13	1	9/16	1.89	--	ES68	1	9/16	1.35	--	ES143	1	9/16	1.60	--
ES14	1	7/16	1.88	--	ES69	1	12MM	1.58	--	ES145	1	7/16	2.25	--
ES15	1	9/16	2.79	--	ES70	2	7/16	1.88	0.70	ES146	1	12MM	1.37	--
ES16	1	7/16	3.15	--	ES71	1	15MM	2.15	--	ES147	1	12MM	1.97	--
ES17	1	12MM	1.25	--	ES72	1	16MM	1.65	--	ES149	1	1/2	2.36	--
ES18	1	12MM	1.65	--	ES73	1	16MM	1.74	--	ES150	1	3/4	2.24	--
ES19	1	12MM	1.88	--	ES74	1	16MM	1.93	--	ES152	1	20MM	1.69	--
ES20	1	12MM	1.95	--	ES75	1	16MM	2.04	--	ES153	1	14MM	1.55	--
ES21	1	12MM	2.28	--	ES76	1	17/32	1.49	--	ES157	2	1/2	2.05	0.95
ES22	1	1/2	1.25	--	ES77	1	20MM	2.35	--	ES158	1	3/4	3.80	--
ES23	1	1/2	1.31	--	ES78	1	10MM	1.92	--	ES159	2	3/4	3.21	1.03
ES24	1	1/2	1.38	--	ES79	1	21/32	1.58	--	ES160	1	1.00	2.01	--
ES25	1	1/2	1.50	--	ES80	2	25/32	1.69	0.07	ES161	1	16MM	3.95	--
ES26	1	1/2	1.56	--	ES81	1	31/64	1.26	--	ES162	1	16MM	2.60	--
ES27	1	1/2	1.62	--	ES82	1	31/64	1.53	--	ES163	1	7/16	2.50	--
ES28	1	9/16	3.15	--	ES83	1	12MM	1.48	--	ES164	1	1/2	2.26	--
ES29	1	10MM	2.95	--	ES84	1	10MM	1.62	--	ES165	1	1/2	1.75	--
ES30	1	12MM	2.57	--	ES85	1	12MM	2.36	--	ES166	1	5/8	2.97	--
ES31	2	1/2	2.25	1.00	ES86	1	14MM	2.44	--	ES167	1	14MM	2.31	--
ES32	1	1/2	3.34	--	ES87	1	31/64	1.65	--	ES168	1	14MM	2.62	--
ES33	1	12MM	3.15	--	ES88	1	12MM	1.81	--	ES169	1	14MM	1.91	--
ES34	1	9/16	1.66	--	ES89	1	39/64	2.16	--	ES171	1	1/2	1.88	--
ES35	1	5/8	1.38	--	ES90	1	5/8	2.00	--	ES172	1	1/2	2.72	--
ES36	1	3/4	1.75	--	ES91	1	1/2	2.10	--	ES173	1	7/8	2.28	--
ES37	1	12MM	1.01	--	ES92	2	39/64	2.20	0.88	ES174	1	5/8	3.25	--
ES38	1	7/16	2.18	--	ES93	2	39/64	2.57	0.79	ES175	1	16MM	1.96	--
ES39	1	10MM	1.31	--	ES94	1	1/2	2.15	--	ES176	1	16MM	3.72	--
ES40	1	7/16	3.38	--	ES95	1	41/64	2	--	ES177	1	16MM	3.55	--
ES41	1	12MM	3.48	--	ES96	1	45/64	1.57	--	ES178	1	3/4	1.96	--
ES42	1	12MM	3.77	--	ES99	1	14MM	1.42	--	ES179	1	20MM	1.75	--
ES43	1	13MM	1.31	--	ES102	1	10MM	1.77	--	ES181	1	7/16	1.98	--
ES44	1	10MM	2.28	--	ES104	1	20MM	1.58	--	ES182	1	20MM	1.96	--
ES45	1	13MM	1.68	--	ES106	1	10MM	1.48	--	ES183	1	20MM	3.80	--
ES46	1	13MM	1.73	--	ES107	1	12MM	2.15	--	ES184	1	20MM	2.44	--
ES47	1	13MM	2.50	--	ES109	1	10MM	0.95	--	ES185	1	12MM	2.44	--
ES48	1	14MM	1.42	--	ES110	1	16MM	1.61	--	ES187	1	1.00	1.75	--
ES49	1	14MM	1.66	--	ES111	1	9MM	1.78	--	ES188	1	16MM	1.81	--
ES50	1	14MM	1.81	--	ES112	1	12MM	1.08	--	ES190	1	22MM	1.75	--
ES51	1	14MM	1.89	--	ES113	1	16MM	1.49	--	ES191	1	1.00	2.44	--
ES52	1	14MM	1.96	--	ES114	1	12MM	2.04	--	ES192	1	24MM	2.44	--
ES53	1	10MM	1.38	--	ES115	1	10MM	2.02	--	ES193	1	24MM	2.28	--
ES54	1	12MM	2.91	--	ES118	1	12MM	1.31	--	ES194	1	7/8	2.28	--
ES55	1	14MM	2	--	ES120	1	3/4	2.76	--	ES195	1	20MM	4.07	--

# CÓMO ESCOGER EL MEJOR AMORTIGUADOR PARA SU CAMIÓN

## CÓDIGOS DE MONTAJE «S» Y «DS» MONTAJES DE DOBLE PERNO

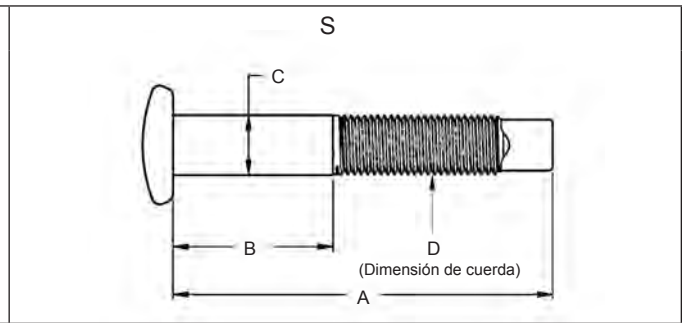
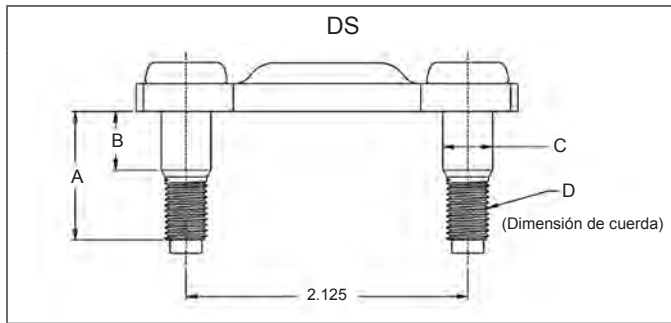

Código de montaje	A	B	C	D
<b>DS1</b>	1.27	0.66	3/8	5/16-24
<b>S1</b>	2.37	1.00	3/8	3/8-24
<b>S2</b>	2.06	1.00	3/8	3/8-24
<b>S3</b>	2.67	1.37	10MM	3/8-16
<b>S4</b>	1.85	1.00	3/8	3/8-24
<b>S5</b>	1.29	1.14	13MM	3/8-24
<b>S6</b>	2.47	1.47	7/16	3/8-24
<b>S7</b>	1.97	1.00	3/8	3/8-24
<b>S8</b>	1.75	1.00	10MM	3/8-24
<b>S9</b>	1.84	1.05	7/16	3/8-24
<b>S10</b>	2.37	1.33	7/16	3/8-24
<b>S11</b>	3.00	1.12	3/8	3/8-24
<b>S12</b>	2.37	1.15	7/16	3/8-24
<b>S13</b>	2.06	1.35	3/8	3/8-24
<b>S14</b>	2.25	1.33	7/16	3/8-24
<b>S15</b>	3.29	1.98	3/8	3/8-24
<b>S16</b>	2.95	1.45	16MM	16MM
<b>S17</b>	2.15	1.03	7/16	3/8-24
<b>S18</b>	2.67	1.81	10MM	M10x1.25
<b>S19</b>	1.34	0.41	7/16	M10x1
<b>S20</b>	1.34	0.41	10MM	M10x1
<b>S21</b>	3.28	1.75	5/8	5/8-18
<b>S22</b>	0.75	0.35	10MM	M10x1
<b>S23</b>	1.84	1.05	3/8	3/8-24
<b>S24</b>	1.22	0.31	11MM	M10x1
<b>S25</b>	1.81	1.50	3/8	M10x1
<b>S26</b>	2.02	0.82	12MM	M10x1
<b>S27</b>	2.36	1.14	10MM	M10x1
<b>S28</b>	2.44	1.37	12MM	M10x1
<b>S29</b>	2.99	1.87	3/8	3/8-24
<b>S30</b>	2.59	1.41	10MM	M10x1
<b>S31</b>	0.79	0.40	17MM	10MM
<b>S32</b>	2.31	1.38	14MM	12MM
<b>S33</b>	3.44	2.17	10MM	M10x1
<b>S34</b>	1.06	0.59	5/16	M8x1.25
<b>S35</b>	2.60	1.12	7/16	3/8-24

Código de montaje	A	B	C	D
<b>S36</b>	2.49	1.33	7/16	3/8-24
<b>S37</b>	3.18	1.41	12MM	M10x1
<b>S38</b>	2.75	1.70	14MM	12MM
<b>S39</b>	2.20	1.31	10MM	10MM
<b>S40</b>	2.52	1.33	7/16	3/8-24
<b>S41</b>	3.48	2.32	5/8	1/2-20
<b>S42</b>	3.50	2.00	5/8	5/8-18
<b>S43</b>	2.75	1.25	5/8	5/8-18
<b>S44</b>	1.57	0.39	10MM	M10x1.25
<b>S45</b>	2.36	1.00	10MM	M10x1.25
<b>S46</b>	1.57	1.18	10MM	M10x1.25
<b>S47</b>	2.20	1.31	10MM	M10x1.25
<b>S48</b>	2.55	1.51	10MM	M10x1.25
<b>S49</b>	2.67	1.29	10MM	M10x1.25
<b>S50</b>	2.95	1.57	10MM	M10x1.25
<b>S51</b>	3.00	1.65	10MM	M10x1.25
<b>S52</b>	1.18	0.74	10MM	M10x1.5
<b>S53</b>	2.16	1.89	10MM	M10x1.5
<b>S54</b>	2.42	1.28	15MM	M10x1.5
<b>S55</b>	2.51	1.39	10MM	M10x1.5
<b>S56</b>	2.67	1.53	11MM	M10x1.5
<b>S57</b>	2.95	1.40	27/64	M10x1.5
<b>S58</b>	2.98	1.68	10MM	M10x1.5
<b>S59</b>	2.98	1.68	12MM	M10x1.5
<b>S60</b>	3.46	1.96	9/16	M10x1.5
<b>S61</b>	3.11	1.45	14MM	M12x1.25
<b>S62</b>	3.24	1.70	9/16	M12x1.25
<b>S63</b>	3.54	2.24	17MM	M12x1.25
<b>S64</b>	2.36	1.18	12MM	M12x1.5
<b>S65</b>	2.89	1.65	12MM	M12x1.5
<b>S66</b>	1.39	0.15	12MM	M12x1.75
<b>S67</b>	2.40	1.53	9/16	M14x1.5
<b>S68</b>	2.95	1.45	5/8	M16x1.5
<b>S69</b>	1.32	1.37	39/64	M16x2
<b>S70</b>	1.88	0.90	7/16	M8x1.25

# CÓMO ESCOGER EL MEJOR AMORTIGUADOR PARA SU CAMIÓN

## EXPLICACIÓN DE LOS TÍTULOS DE LAS COLUMNAS

<b>Número de parte del amortiguador:</b> El número de catálogo para el amortiguador individual.
<b>Longitud extendida :*</b> La longitud del amortiguador cuando está totalmente extendido. Ver instrucciones «Cómo medir».
<b>Longitud comprimida :*</b> La longitud del amortiguador cuando está totalmente comprimido. Ver instrucciones «Cómo medir».
<b>Carrera :</b> Es la longitud aproximada del recorrido del amortiguador descrito.
<b>Códigos de montaje :</b> Indica el tipo de montajes superior e inferior para cada amortiguador.  Se enlistan como sigue : Montajes tipo perno («S» y «DS») Montajes anillo y buje («EB») Montajes anillo y buje con camisa («ES») Montajes anillo y buje con clavija («BP») Códigos de montajes especiales («SP»)
<b>Polvera:</b> Indica si el amortiguador cuenta con una polvera.
<b>Número de paquete de accesorios de montaje:</b> El número de parte del paquete de accesorios de montaje proveído con el amortiguador.
<b>*Nota :</b> Todas las dimensiones son en pulgadas

**4º PASO:** Consulte las especificaciones del amortiguador mostradas al final del catálogo. Encuentre primero la serie adecuada. Luego, compare las longitudes de extensión y de compresión, y encuentre los códigos de montaje correctos. Consulte la columna del extremo izquierdo de la tabla para identificar el número de parte del amortiguador GRC correcto.



## ESPECIFICACIONES POR TIPO DE MONTAJE

GRC	Montajes		Calibre de Pistón	Imagen de Diámetro Exterior	Longitudes [in]			Polvera	Tope Hidráulico	Fuerza*	
	Superior	Inferior			Extendido	Comprimido	Carrera			Rebote	Compresión
83171		ES36	1-3/8"	A	23.98	14.51	9.47	Sí	Sí	513	146
69464	384557-1	ES41			24.2	15.93	8.27				
G56628	B2				21.5	13.62	7.87				
G56629	B2				21.5	13.62	7.87				
G56679	B2				21.26	15.9	5.36				
G56680	B2				21.26	15.9	5.36				
G56801	B2				17.25	11.75	5.5				
G56790	B7				18.5	12.87	5.62				
G56767	B9				21.75	14.37	7.37				
G56768	B9				21.75	14.37	7.37				
G56762	B9				20.5	14.00	6.5				
G56683	B10				21.12	14.37	6.75				
G56684	B10				21.12	14.37	6.75				
G56671	B10				20.5	13.62	6.87				
G56672	B10				20.5	13.61	6.87				
G56805	B10				18.75	12.75	6.00				
G56806	B10				18.75	12.75	6.00				
G56685	B11				21.12	14.37	6.75				
G56686	B11				21.12	14.37	6.75				
G56802	B11				20.75	14.12	6.63				
G56795	B11				20.62	14.75	5.87				
G56819	B12				21.35	15.18	6.16				
G56820	B12				21.35	15.18	6.16				
G56773	B13				20.94	12.87	8.07				
G56774	B13				20.94	12.87	8.07				
G56803	B16				21.43	14.98	6.45				
G56758	B17				21.75	14.50	7.25				
G56799	B17				21.1	14.53	6.57				
G56800	B17				21.1	14.53	6.57				
G56772	B18				20.8	13.38	7.42				
81076	BP4	DS1			14.2	9.44	4.76				
82012	BP6	ES25			16.04	10.53	5.51				
83013	BP8	BP8	1-3/16"	2" D/T	7.66	6.63†	1.7	Sí	NO	646	480
82602	BP8	EB1			23.23	13.87	9.36				
82051	BP8	EB1			22.14	13.28	8.86				
43180	BP8	ES34			23.55	14.19	9.36				
G63837	BP8	ES41			28.23	17.95	10.28				
83015	BP8	S1	1-3/8"	A	9.79	7.55	2.24	Sí	Sí	735	430
83005	BP8	S10	1-3/16"	2" D/T	7.34	5.87	1.47	Sí	NO	858	216
G63879	BP10	ES34			23	14.31	8.69				
G63882	BP10	ES34			21	13.31	7.69				
G63499	BP13	ES26			25.58	15.3	10.28				
61584	BP13	ES26			25.48	15.2	10.28				

\* Damping force, in pounds, to either extend or collapse the shock absorber at an average operating velocity. Fuerza de amortiguación en libras para extender o comprimir el amortiguador a una velocidad de operación promedio. La puissance d'amortissement en poids de l'amortisseur, soit comprimé, doit détendu, à une vitesse de fonctionnement moyenne.

† At bumper contact / Al contacto con el tope de goma / Au contact avec le butoir

## ESPECIFICACIONES POR TIPO DE MONTAJE

GRC	Montajes		Calibre de Pistón	Imagen de Diámetro Exterior	Longitudes [in]			Polvera	Tope Hidráulico	Fuerza*	
	Superior	Inferior			Extendido	Comprimido	Carrera			Rebote	Compresión
81837	BP13	ES27			26.28	15.42	10.86				
61511	BP13	ES27			23.16	14.13	9.03				
G63460	BP13	ES27			23.16	14.13	9.03				
81560	BP13	ES27			23.14	13.78	9.36				
82618	BP14	EB1			25.73	15.12	10.61				
49128	BP14	EB1			22.77	14.04	8.73				
49157	BP14	EB1			21.37	13.29	8.08				
49193	BP14	ES10			21.27	13.29	7.98				
81438	BP14	ES10			20.23	12.37	7.86				
81667	BP14	ES34			26.95	16.19	10.76				
77488	BP14	ES34			26.77	16.26	10.51				
61543	BP14	ES34			26.76	16.23	10.53				
58488	BP14	ES34			26.68	16.05	10.63				
G63488	BP14	ES34			26.61	16.33	10.28				
49218	BP14	ES34			26.34	16.36	9.98				
61688	BP14	ES34			25.19	15.31	9.88				
G63898	BP14	ES34			25.19	15.31	9.88				
43163	BP14	ES34			25.05	15.69	9.36				
G63638	BP14	ES34			24.33	14.8	9.53				
77638	BP14	ES34			24.31	14.78	9.53				
49213	BP14	ES34			24.27	14.79	9.48				
49231	BP14	ES34			24.27	14.79	9.48				
61565	BP14	ES34			24.26	14.73	9.53				
81482	BP14	ES34			24.23	14.37	9.86				
G63965	BP14	ES34			24.14	15.2	8.94				
G63422	BP14	ES34			24.01	14.48	9.53				
61528	BP14	ES34			23.98	14.45	9.53				
77422	BP14	ES34			23.92	14.39	9.53				
58422	BP14	ES34			23.87	14.49	9.38				
58638	BP14	ES34			23.87	14.49	9.38				
61687	BP14	ES34			23.87	14.68	9.19				
G63897	BP14	ES34			23.87	14.68	9.19				
81789	BP14	ES34			23.73	14.12	9.61				
43162	BP14	ES34			22.99	14.38	8.61				
61686	BP14	ES34			22.36	13.92	8.44				
G63896	BP14	ES34			22.36	13.92	8.44				
69727	BP14	ES53			13.13	9.12	4.01				
77607	BP14	ES83			25.39	15.18	10.21				
77679	BP14	ES83			24.9	14.88	10.02				
49225	BP14	ES185			25.77	15.54	10.23				
81823	BP14	ES185			25.73	15.12	10.61				
G63607	BP14	ES185			25.58	15.3	10.28				
43172	BP14	ES185			25.55	16.19	9.36				

\* Damping force, in pounds, to either extend or collapse the shock absorber at an average operating velocity. Fuerza de amortiguación en libras para extender o comprimir el amortiguador a una velocidad de operación promedio. La puissance d'amortissement en poids de l'amortisseur, soit comprimé, doit détendu, à une vitesse de fonctionnement moyenne.

## ESPECIFICACIONES POR TIPO DE MONTAJE

GRC	Montajes		Calibre de Pistón	Imagen de Diámetro Exterior	Longitudes [in]			Polvera	Tope Hidráulico	Fuerza*	
	Superior	Inferior			Extendido	Comprimido	Carrera			Rebote	Compresión
61590	BP14	ES185			25.48	15.2	10.28				
81890	BP14	ES185			25.28	14.92	10.36				
49232	BP14	ES185			25.09	15.16	9.93				
G63679	BP14	ES185			25.01	14.98	10.03				
61624	BP14	ES185			24.98	14.95	10.03				
43171	BP14	ES185			24.74	15.38	9.36				
69624	BP14	S1			21.7	12.84	8.86				
81095	BP14	S1			21.7	12.84	8.86				
49135	BP14	S1			21.62	13.14	8.48				
43084	BP14	S1			21.42	12.84	8.58				
70010	BP15	ES69			22.56	14.09	8.47				
69585	BP18	ES18			22.5	13.99	8.51				
G63880	BP18	ES18			22.5	14.06	8.44				
61697	BP18	ES26			22.62	14.43	8.19				
G63967	BP18	ES26			22.62	14.43	8.19				
61696	BP18	ES26			22.45	14.5	7.95				
G63966	BP18	ES26			22.45	14.5	7.95				
82104	BP19	DS1			14.2	9.44	4.76				
49226	BP20	EB1			20.77	13.04	7.73				
81549	BP20	EB1			20.73	12.62	8.11				
G63425	BP20	EB1			20.01	12.48	7.53				
61536	BP20	EB1			19.98	12.45	7.53				
81929	BP20	ES24			19.49	12.13	7.36				
G63722	BP20	ES24			19.49	12.21	7.28				
61616	BP20	ES24			19.39	12.23	7.16				
69733	BP27	ES137			17.88	12.72	5.16				
81450	BP27	ES137			17.88	12.72	5.16				
83041	BP27	S10	1-3/8"	A	10.51†	8.34†	3.02	SÍ	SÍ	486	189
49131	BP31	EB1			22.15	13.67	8.48				
69724	BP31	EB1			22.14	13.28	8.86				
81514	BP31	EB1			22.14	13.28	8.86				
43049	BP31	EB1			21.86	13.28	8.58				
49334	BP31	EB1			20.7	13.05	7.65				
69604	BP31	EB1			20.64	12.78	7.86				
81492	BP31	EB1			20.64	12.78	7.86				
49152	BP31	EB1			20.27	13.04	7.23				
82093	BP31	ES10			21.23	12.87	8.36				
70001	BP34	ES72			22.52	13.94	8.58				
83060	EB	BP7	1-3/8"	A	9.76	7.98†	2.25	NO	SÍ	431	441
77425	EB1	BP20			19.87	12.23	7.64				
43060	EB1	BP31			20.2	12.55	7.65				
G63692	EB1	EB1			27.58	16.3	11.28				
G63440	EB1	EB1			26.33	15.55	10.78				

\* Damping force, in pounds, to either extend or collapse the shock absorber at an average operating velocity. Fuerza de amortiguación en libras para extender o comprimir el amortiguador a una velocidad de operación promedio. La puissance d'amortissement en poids de l'amortisseur, soit comprimé, doit détendu, à une vitesse de fonctionnement moyenne.

† At bumper contact / Al contacto con el tope de goma / Au contact avec le butoir

## ESPECIFICACIONES POR TIPO DE MONTAJE

GRC	Montajes		Calibre de Pistón	Imagen de Diámetro Exterior	Longitudes [in]			Polvera	Tope Hidráulico	Fuerza*	
	Superior	Inferior			Extendido	Comprimido	Carrera			Rebote	Compresión
G63660	EB1	EB1			25.08	15.05	10.03				
61582	EB1	EB1			24.98	14.95	10.03				
77660	EB1	EB1			24.9	14.88	10.02				
81538	EB1	EB1			24.23	14.37	9.86				
83401	EB1	EB1	1-3/16"	F	24.09	14.26	9.83	SÍ	NO	341	252
6804SE	EB1	EB1			24.08	14.67	9.41				
G63419	EB1	EB1			24.08	14.55	9.53				
14017	EB1	EB1			24.04	14.43	9.61				
61532	EB1	EB1			23.98	14.45	9.53				
6855SE	EB1	EB1			23.83	14.3	9.53				
G63443	EB1	EB1			23.33	13.95	9.38				
82060	EB1	EB1			23.23	13.87	9.36				
82610	EB1	EB1			23.23	13.87	9.36				
6854SE	EB1	EB1			23.03	14.27	8.76				
81318	EB1	EB1			22.73	13.87	8.86				
G63928	EB1	EB1			22.73	13.87	8.86				
G63492	EB1	EB1			22.58	13.8	8.78				
49311	EB1	EB1			22.44	14	8.44				
77492	EB1	EB1			22.33	13.6	8.73				
61506	EB1	EB1			21.86	13.58	8.28				
G63173	EB1	EB1			21.86	13.58	8.28				
6828SE	EB1	EB1			21.23	12.87	8.36				
83510	EB1	EB1	1-3/16"		21.2	13.09	8.11	SÍ	NO	463	41
77183	EB1	EB1			20.86	13.01	7.85				
83508	EB1	EB1	1-3/16"		20.76	12.62	8.14	SÍ	NO	698	183
43048	EB1	EB1			20.45	12.62	7.83				
49151	EB1	EB1			20.35	12.83	7.52				
49310	EB1	EB1			20.35	12.75	7.60				
61500	EB1	EB1			20.23	12.37	7.86				
81147	EB1	EB1			20.23	12.37	7.86				
82047	EB1	EB1			20.23	12.37	7.86				
82156	EB1	EB1			20.23	12.37	7.86				
G63907	EB1	EB1			20.23	12.37	7.86				
G63405	EB1	EB1			20.01	12.48	7.53				
77405	EB1	EB1			19.87	12.23	7.64				
77907	EB1	EB1			19.87	12.23	7.64				
6807SE	EB1	EB1			19.73	12.12	7.61				
6801SE	EB1	EB1			19.33	12.16	7.17				
G63689	EB1	EB1			19.08	12.05	7.03				
83007	EB1	EB1	1-3/8"	A	18.54	11.67	6.87	NO	NO	489	343
82007	EB1	EB1			18.23	11.37	6.86				
G63299	EB1	EB1			18.08	11.55	6.53				
61637	EB1	EB1			17.98	11.45	6.53				

\* Damping force, in pounds, to either extend or collapse the shock absorber at an average operating velocity. Fuerza de amortiguación en libras para extender o comprimir el amortiguador a una velocidad de operación promedio. La puissance d'amortissement en poids de l'amortisseur, soit comprimé, doit détendu, à une vitesse de fonctionnement moyenne.

## ESPECIFICACIONES POR TIPO DE MONTAJE

GRC	Montajes		Calibre de Pistón	Imagen de Diámetro Exterior	Longitudes [in]			Polvera	Tope Hidráulico	Fuerza*	
	Superior	Inferior			Extendido	Comprimido	Carrera			Rebote	Compresión
61550	EB1	EB1			17.73	11.12	6.61				
81676	EB1	EB1			17.73	11.12	6.61				
G63949	EB1	EB1			17.73	11.12	6.61				
69884	EB1	EB1			16.73	10.62	6.11				
82607	EB1	EB1			14.73	9.62	5.11				
82139	EB1	EB1			12.98	9.97	3.01				
83011	EB1	EB1	1-3/8"	A	11.55†	8.43	3.62	Sí	Sí	738	330
83012	EB1	EB1	1-3/8"	A	11.05†	8.18	3.37	Sí	Sí	738	330
58625	EB1	EB20			22.36	13.83	8.53				
G63625	EB1	ES24			22.56	13.78	8.78				
14040	EB1	ES24			19.73	12.12	7.61				
6853SE	EB1	ES24			19.33	12.05	7.28				
G63394	EB1	ES24			16.01	10.48	5.53				
61525	EB1	ES24			15.01	9.95	5.06				
G63355	EB1	ES24			14.98	9.95	5.03				
77355	EB1	ES24			14.85	9.86	4.99				
81039	EB1	ES24			14.73	9.62	5.11				
34036	EB1	ES24			14.16	9.53	4.63				
G63441	EB1	ES25			26.33	15.55	10.78				
82147	EB1	ES25			23.23	13.87	9.36				
81484	EB1	ES25			20.23	12.37	7.86				
G63377	EB1	ES25			20.08	12.55	7.53				
61519	EB1	ES25			19.98	12.45	7.53				
43058	EB1	ES25			19.95	12.37	7.58				
49127	EB1	ES25			19.87	12.63	7.24				
58377	EB1	ES25			19.87	12.49	7.38				
77377	EB1	ES25			19.87	12.23	7.64				
G63490	EB1	ES25			19.08	12.05	7.03				
49222	EB1	ES25			18.77	12.04	6.73				
77389	EB1	ES27			28.73	16.92	11.81				
58438	EB1	ES34			29.68	17.55	12.13				
G63438	EB1	ES34			29.33	17.3	12.03				
G63349	EB1	ES34			23.33	14.3	9.03				
77349	EB1	ES34			23.32	14.29	9.03				
49155	EB1	ES34			23.27	14.29	8.98				
61524	EB1	ES34			23.26	14.23	9.03				
81164	EB1	ES34			23.23	13.87	9.36				
58349	EB1	ES34			23.18	14.3	8.88				
69595	EB1	ES34			20.34	12.83	7.51				
69594	EB1	ES34			19.42	12.41	7.01				
82609	EB1	ES35			25.64	15.03	10.61				
14020	EB1	ES39			19.75	12.05	7.70				
61682	EB1	ES41			31.36	18.67	12.69				

\* Damping force, in pounds, to either extend or collapse the shock absorber at an average operating velocity. Fuerza de amortiguación en libras para extender o comprimir el amortiguador a una velocidad de operación promedio. La puissance d'amortissement en poids de l'amortisseur, soit comprimé, soit détendu, à une vitesse de fonctionnement moyenne.

† At bumper contact / Al contacto con el tope de goma / Au contact avec le butoir

## ESPECIFICACIONES POR TIPO DE MONTAJE

GRC	Montajes		Calibre de Pistón	Imagen de Diámetro Exterior	Longitudes [in]			Polvera	Tope Hidráulico	Fuerza*	
	Superior	Inferior			Extendido	Comprimido	Carrera			Rebote	Compresión
G63888	EB1	ES41			31.36	18.67	12.69				
61681	EB1	ES41			29.71	17.77	11.94				
G63887	EB1	ES41			29.71	17.77	11.94				
G63461	EB1	ES41			25.51	15.23	10.28				
G63811	EB1	ES41			25.51	15.23	10.28				
49214	EB1	ES41			23.27	14.29	8.98				
49223	EB1	ES41			23.27	14.29	8.98				
6847SE	EB1	ES65			23	13.83	9.17				
77810	EB1	ES83			31.53	18.5	13.03				
77808	EB1	ES83			28.73	16.92	11.81				
61713	EB1	ES83			26.94	16	10.94				
G64010	EB1	ES83			26.94	16	10.94				
77524	EB1	ES83			26.87	15.87	11.00				
77456	EB1	ES83			26.73	15.94	10.79				
77461	EB1	ES83			25.39	15.18	10.21				
77406	EB1	ES83			22.92	13.9	9.02				
77809	EB1	ES83			22.92	13.9	9.02				
77525	EB1	ES83			22.9	14	8.90				
77409	EB1	ES83			21.54	13.11	8.43				
G63420	EB1	ES106			27.08	16.05	11.03				
61534	EB1	ES106			26.98	15.95	11.03				
81540	EB1	ES106			25.73	15.12	10.61				
81539	EB1	ES106			23.23	13.87	9.36				
61533	EB1	ES106			22.98	13.95	9.03				
G63427	EB1	ES106			22.98	13.95	9.03				
49207	EB1	ES106			22.81	14.06	8.75				
G63604	EB1	ES142			19.74	12.46	7.28				
61568	EB1	ES142			19.64	12.36	7.28				
G63810	EB1	ES185			31.6	18.57	13.03				
58810	EB1	ES185			31.42	18.42	13.00				
G63439	EB1	ES185			29.76	17.23	12.53				
77952	EB1	ES185			29.68	17.43	12.25				
G63808	EB1	ES185			28.86	17.08	11.78				
G63524	EB1	ES185			27.08	16.05	11.03				
G63775	EB1	ES185			27.08	16.05	11.03				
61573	EB1	ES185			26.98	15.95	11.03				
81905	EB1	ES185			26.97	15.86	11.11				
81918	EB1	ES185			26.97	15.86	11.11				
G63456	EB1	ES185			26.85	16.07	10.78				
49241	EB1	ES185			25.77	15.54	10.23				
81510	EB1	ES185			25.73	15.12	10.61				
61530	EB1	ES185			25.48	15.2	10.28				
G63964	EB1	ES185			25.48	15.53	9.95				

\* Damping force, in pounds, to either extend or collapse the shock absorber at an average operating velocity. Fuerza de amortiguación en libras para extender o comprimir el amortiguador a una velocidad de operación promedio. La puissance d'amortissement en poids de l'amortisseur, soit comprimé, soit détendu, à une vitesse de fonctionnement moyenne.

## ESPECIFICACIONES POR TIPO DE MONTAJE

GRC	Montajes		Calibre de Pistón	Imagen de Diámetro Exterior	Longitudes [in]			Polvera	Tope Hidráulico	Fuerza*	
	Superior	Inferior			Extendido	Comprimido	Carrera			Rebote	Compresión
77969	EB1	ES185			25.43	15.81	9.62				
58811	EB1	ES185			25.36	15.23	10.13				
49217	EB1	ES185			25.27	15.29	9.98				
G63963	EB1	ES185			24.75	15.06	9.69				
77968	EB1	ES185			24.71	15.09	9.62				
58809	EB1	ES185			23.65	14.53	9.12				
81082	EB1	ES185			23.23	13.87	9.36				
81730	EB1	ES185			23.23	13.87	9.36				
81917	EB1	ES185			23.03	13.92	9.11				
61559	EB1	ES185			22.98	13.95	9.03				
G63406	EB1	ES185			22.98	13.95	9.03				
G63525	EB1	ES185			22.98	13.95	9.03				
G63773	EB1	ES185			22.98	13.95	9.03				
G63809	EB1	ES185			22.98	13.95	9.03				
58406	EB1	ES185			22.87	13.99	8.88				
81710	EB1	ES185			21.73	13.12	8.61				
G63409	EB1	ES185			21.48	13.2	8.28				
58409	EB1	ES185			21.37	13.24	8.13				
49197	EB1	ES185			21.27	13.29	7.98				
6850SE	EB1	S1			23.3	13.77	9.53				
G63491	EB1	S1			19.05	11.77	7.28				
61505	EB1	S1			18.95	11.67	7.28				
49309	EB1	S1			18.52	11.5	7.02				
81097	EB1	S1			18.2	11.09	7.11				
G63620	EB1	S17			19.55	12.27	7.28				
61594	EB1	S17			19.45	12.17	7.28				
82130	EB1	S36			17.7	10.84	6.86				
85063	EB2	EB2	1-5/8"	C	32.01	18.85	13.16	SÍ	NO	762	174
83107	EB2	EB2	1-3/8"	A	31.6	18.36	13.24	SÍ	NO	352	77
83314	EB2	EB2	1-3/8"	B	30.64	18.11	12.53	SÍ	SÍ	633	143
85024	EB2	EB2	1-5/8"	C	28.74	17.21	11.53	SÍ	SÍ	1008	539
83309	EB2	EB2	1-3/8"	B	28.64	17.11	11.53	SÍ	SÍ	589	135
89416	EB2	EB2	1-5/8"	G	28.62	17.54	11.08	SÍ	SÍ	1155‡	514
89401	EB2	EB2	1-5/8"	G	28.41	17.16	11.25	SÍ	NO	665‡	194
89446	EB2	EB2	1-5/8"	G	28.36	17.41	10.95	SÍ	SÍ	702‡	204
85046	EB2	EB2	1-5/8"	C	27.51	16.6	10.91	SÍ	SÍ	1008	539
89434	EB2	EB2	1-5/8"	G	27.12	16.79	10.33	SÍ	SÍ	1155‡	514
89403	EB2	EB2	1-5/8"	G	26.86	17.16	9.7	SÍ	SÍ	929‡	281
83312	EB2	EB2	1-3/8"	B	26.64	16.11	10.53	SÍ	SÍ	527	152
89409	EB2	EB2	1-5/8"	G	26.36	16.41	9.95	SÍ	SÍ	567‡	165
89439	EB2	EB2	1-5/8"	G	25.67	15.79	9.88	SÍ	NO	518‡	103
85055	EB2	EB2	1-5/8"	C	25.63	15.6	10.03	SÍ	NO	577	102
85047	EB2	EB2	1-5/8"	C	25.25	15.47	9.78	SÍ	SÍ	1008	539

\* Damping force, in pounds, to either extend or collapse the shock absorber at an average operating velocity. Fuerza de amortiguación en libras para extender o comprimir el amortiguador a una velocidad de operación promedio. La puissance d'amortissement en poids de l'amortisseur, soit comprimé, doit détendu, à une vitesse de fonctionnement moyenne.

‡ For GasSLX Series, forces are at the "Firm" (F) setting. / Para la serie GasSLX, las fuerzas están ajustadas en (F) "Firme". / Pour la série GasSLX, le réglage de la force est sur «Firme» (F).

## ESPECIFICACIONES POR TIPO DE MONTAJE

GRC	Montajes		Calibre de Pistón	Imagen de Diámetro Exterior	Longitudes [in]			Polvera	Tope Hidráulico	Fuerza*	
	Superior	Inferior			Extendido	Comprimido	Carrera			Rebote	Compresión
83308	EB2	EB2	1-3/8"	B	25.14	15.36	9.78	SÍ	SÍ	445	180
83505	EB2	EB2	1-3/16"	F	25	14.94	10.06	SÍ	NO	399	141
89435	EB2	EB2	1-5/8"	G	24.86	15.66	9.2	SÍ	SÍ	1155‡	514
83200	EB2	EB2	1-3/8"	A	24.51	15.1	9.53	SÍ	NO	806	370
89402	EB2	EB2	1-5/8"	G	24.41	15.16	9.25	SÍ	NO	874‡	206
85074	EB2	EB2	1-5/8"	C	24.01	14.85	9.15	SÍ	SÍ	1021	126
83216	EB2	EB2	1-3/8"	A	23.51	14.48	9.03	SÍ	NO	776	262
85054	EB2	EB2	1-5/8"	C	23.26	14.35	8.91	SÍ	NO	602	104
89438	EB2	EB2	1-5/8"	G	23.17	14.54	8.63	SÍ	NO	583‡	103
83506	EB2	EB2	1-3/16"	F	22.6	13.76	8.84	SÍ	NO	441	119
61510	EB2	EB2			22.29	13.76	8.53				
81871	EB2	EB2			22.04	13.43	8.61				
83404	EB2	EB2	1-3/16"	F	22.01	13.44	8.58	SÍ	NO	545	171
77494	EB2	EB2			21.78	13.52	8.26				
83159	EB2	EB2	1-3/8"	A	21.62	13.4	8.14	SÍ	NO	658	149
85012	EB2	EB2	1-5/8"	C	21	13.22	7.78	SÍ	NO	523	199
89413	EB2	EB2	1-5/8"	G	20.91	13.41	7.5	SÍ	NO	536‡	201
61700	EB2	EB2			20.37	13.11	7.26				
85023	EB2	EB2	1-5/8"	C	20.24	12.96	7.28	SÍ	SÍ	1008	539
89415	EB2	EB2	1-5/8"	G	20.12	13.29	6.83	SÍ	SÍ	1155‡	514
83219	EB2	EB2	1-3/8"	A	20.01	12.73	7.28	SÍ	NO	299	125
85062	EB2	EB2	1-5/8"	C	19.76	12.6	7.2	SÍ	NO	523	199
89408	EB2	EB2	1-5/8"	G	19.67	12.79	6.88	SÍ	NO	536‡	201
61699	EB2	EB2			19.41	12.65	6.76				
83511	EB2	EB2	1-3/16"		17.73	11.32	6.41	SÍ	NO	615	274
83179	EB2	EB2	1-3/8"	A	10.76†	8.57†	3.02	SÍ	NO	909	278
85077	EB2	ES56	1-5/8"	C	23.97	14.85	9.12	SÍ	SÍ	955	120
85025	EB2	S21	1-5/8"	C	23	13.97	9.03	SÍ	NO	1079	539
85941	EB3	EB3	1-5/8"	G	33.38	20.12	13.26	SÍ	SÍ	1263	161
85376	EB3	EB3	1-5/8"	D	33.25	19.72	13.53	SÍ	NO	668	134
85940	EB3	EB3	1-5/8"	G	32.75	19.8	12.95	SÍ	SÍ	1545	398
85949	EB3	EB3	1-5/8"	G	32.75	19.76	12.99	SÍ	SÍ	968	136
85301	EB3	EB3	1-5/8"	D	31.92	19.03	12.89	SÍ	NO	1442	455
85339	EB3	EB3	1-5/8"	D	31.68	19.02	12.66	SÍ	SÍ	804	463
85948	EB3	EB3	1-5/8"	G	31.37	19.09	12.28	SÍ	SÍ	1485	236
85951	EB3	EB3	1-5/8"	G	30.98	18.9	12.08	SÍ	SÍ	1545	397
85040	EB3	EB3	1-5/8"	C	30.9	18.49	12.41	SÍ	NO	889	114
85730	EB3	EB3	1-5/8"	D	30.75	18.72	12.03	SÍ	SÍ	1517	293
85315	EB3	EB3	1-5/8"	D	29.66	18.15	11.51	SÍ	NO	380	142
85943	EB3	EB3	1-5/8"	G	29.33	17.99	11.34	SÍ	SÍ	1387	396
85944	EB3	EB3	1-5/8"	G	29.33	17.99	11.34	SÍ	SÍ	1093	136
85942	EB3	EB3	1-5/8"	G	29.25	17.99	11.26	SÍ	SÍ	968	91
85901	EB3	EB3	1-5/8"	G	29.05	17.64	11.41	SÍ	NO	1830	418

\* Damping force, in pounds, to either extend or collapse the shock absorber at an average operating velocity. Fuerza de amortiguación en libras para extender o comprimir el amortiguador a una velocidad de operación promedio. La puissance d'amortissement en poids de l'amortisseur, soit comprimé, doit détendu, à une vitesse de fonctionnement moyenne.

† At bumper contact / Al contacto con el tope de goma / Au contact avec le butoir

‡ For GasSLX Series, forces are at the "Firm" (F) setting. / Para la serie GasSLX, las fuerzas están ajustadas en (F) "Firme". / Pour la série GasSLX, le réglage de la force est sur «Firme» (F).



## ESPECIFICACIONES POR TIPO DE MONTAJE

GRC	Montajes		Calibre de Pistón	Imagen de Diámetro Exterior	Longitudes [in]			Polvera	Tope Hidráulico	Fuerza*	
	Superior	Inferior			Extendido	Comprimido	Carrera			Rebote	Compresión
85704	EB3	EB3	1-5/8"	D	28.75	18.72	10.03	SÍ	SÍ	1435	186
83104	EB3	EB3	1-3/8"	A	28.24	17.12	11.12	SÍ	NO	698	133
85305	EB3	EB3	1-5/8"	D	27.25	16.72	10.53	SÍ	NO	1120	225
83362	EB3	EB3	1-3/8"	B	27	16.25	10.75	SÍ	NO	539	202
87004	EB3	EB3	2-1/16"	E	26.76	16.76	10	SÍ	SÍ	1158	190
85735	EB3	EB3	1-5/8"	D	26.74	16.71	10.03	SÍ	SÍ	1288	227
83215	EB3	EB3	1-3/8"	A	26.64	16.36	10.28	SÍ	SÍ	697	108
85314	EB3	EB3	1-5/8"	D	26.5	16.47	10.03	SÍ	SÍ	1216	169
89425	EB3	EB3	1-5/8"	G	26.5	16.8	9.7	SÍ	SÍ	1352‡	167
89410	EB3	EB3	1-5/8"	G	26.33	16.42	9.91	SÍ	NO	1185‡	182
85001	EB3	EB3	1-5/8"	C	26.27	16.36	9.91	SÍ	NO	1202	186
85313	EB3	EB3	1-5/8"	D	26.26	16.35	9.91	SÍ	SÍ	717	111
87003	EB3	EB3	2-1/16"	E	26.26	16.51	9.75	SÍ	SÍ	1332	395
89429	EB3	EB3	1-5/8"	G	26.18	16.43	9.75	SÍ	NO	941‡	266
85320	EB3	EB3	1-5/8"	D	26.13	16.35	9.78	SÍ	NO	970	308
85700	EB3	EB3	1-5/8"	D	26.13	16.6	9.53	SÍ	SÍ	1446	328
83140	EB3	EB3	1-3/8"	A	25.27	15.52	9.75	SÍ	NO	738	88
83141	EB3	EB3	1-3/8"	A	25.27	15.52	9.75	SÍ	NO	408	113
83132	EB3	EB3	1-3/8"	A	25.24	15.5	9.74	SÍ	NO	828	150
85308	EB3	EB3	1-5/8"	D	25.13	15.85	9.28	SÍ	SÍ	764	254
85714	EB3	EB3	1-5/8"	D	25.13	15.85	9.28	SÍ	SÍ	1220	175
85715	EB3	EB3	1-5/8"	D	25.13	15.85	9.28	SÍ	SÍ	1915	200
85717	EB3	EB3	1-5/8"	D	25.13	15.85	9.28	SÍ	SÍ	1915	200
89422	EB3	EB3	1-5/8"	G	25.13	16.18	8.95	SÍ	SÍ	794‡	253
85303	EB3	EB3	1-5/8"	D	24.75	15.47	9.28	SÍ	NO	1019	221
85053	EB3	EB3	1-5/8"	C	24.65	15.49	9.16	SÍ	NO	1019	227
89442	EB3	EB3	1-5/8"	G	24.55	15.55	9	SÍ	NO	1055‡	224
85329	EB3	EB3	1-5/8"	D	24.5	15.47	9.03	SÍ	SÍ	1550	232
85713	EB3	EB3	1-5/8"	D	24.5	15.47	9.03	SÍ	SÍ	1157	180
89412	EB3	EB3	1-5/8"	G	24.26	15.68	8.58	SÍ	SÍ	1155‡	169
85007	EB3	EB3	1-5/8"	C	24.21	15.3	8.91	SÍ	SÍ	1008	171
83225	EB3	EB3	1-3/8"	A	24.14	15.11	9.03	SÍ	SÍ	482	159
85307	EB3	EB3	1-5/8"	D	24.01	15.1	8.91	SÍ	NO	1094	173
85702	EB3	EB3	1-5/8"	D	23.76	15.85	7.91	SÍ	SÍ	1093	825
87006	EB3	EB3	2-1/16"	E	23.75	15.25	8.5	SÍ	SÍ	1158	272
85736	EB3	EB3	1-5/8"	D	23.62	15.21	8.41	SÍ	SÍ	1155	352
87002	EB3	EB3	2-1/16"	E	23.5	15.41	8.09	SÍ	SÍ	879	203
85983	EB3	EB3	1-5/8"	G	22.95	14.7	8.25	SÍ	NO	1101	366
89420	EB3	EB3	1-5/8"	G	22.81	14.68	8.13	SÍ	NO	862‡	258
83217	EB3	EB3	1-3/8"	A	22.77	14.49	8.28	SÍ	SÍ	539	202
85302	EB3	EB3	1-5/8"	D	22.75	14.66	8.09	SÍ	NO	836	253
85304	EB3	EB3	1-5/8"	D	22.25	14.22	8.03	SÍ	NO	767	325
85718	EB3	EB3	1-5/8"	D	22.13	15.04	7.09	SÍ	SÍ	2506	206

\* Damping force, in pounds, to either extend or collapse the shock absorber at an average operating velocity. Fuerza de amortiguación en libras para extender o comprimir el amortiguador a una velocidad de operación promedio. La puissance d'amortissement en poids de l'amortisseur, soit comprimé, doit détendu, à une vitesse de fonctionnement moyenne.

‡ For GasSLX Series, forces are at the "Firm" (F) setting. / Para la serie GasSLX, las fuerzas están ajustadas en (F) "Firme". / Pour la série GasSLX, le réglage de la force est sur «Ferme» (F).

## ESPECIFICACIONES POR TIPO DE MONTAJE

GRC	Montajes		Calibre de Pistón	Imagen de Diámetro Exterior	Longitudes [in]			Polvera	Tope Hidráulico	Fuerza*	
	Superior	Inferior			Extendido	Comprimido	Carrera			Rebote	Compresión
85732	EB3	EB3	2-1/16"	E	22.13	15.11	7.03	SÍ	SÍ	2632	382
85716	EB3	EB3	1-5/8"	D	22.01	14.35	7.66	SÍ	SÍ	1220	175
87001	EB3	EB3	2-1/16"	E	20.76	13.76	7	SÍ	SÍ	1158	190
85734	EB3	EB3	1-5/8"	D	20.74	13.71	7.03	SÍ	SÍ	1288	227
85004	EB3	EB3	1-5/8"	C	20.68	13.67	7.01	SÍ	SÍ	1019	219
85042	EB3	EB3	1-5/8"	C	20.64	13.61	7.03	SÍ	SÍ	333	161
85712	EB3	EB3	1-5/8"	D	20.5	13.47	7.03	SÍ	SÍ	1435	562
85720	EB3	EB3	1-5/8"	D	20.5	13.47	7.03	SÍ	SÍ	1435	562
85968	EB3	EB3	1-5/8"	G	19.87	13.39	6.48	SÍ	SÍ	1069	227
83214	EB3	EB3	1-3/8"	A	19.64	12.86	6.78	SÍ	NO	269	90
85300	EB3	EB3	1-5/8"	D	18	12.22	5.78	SÍ	SÍ	1435	676
89419	EB3	EB3	1-5/8"	G	18	12.55	5.45	SÍ	SÍ	1352‡	636
85719	EB3	EB3	1-5/8"	D	17.25	11.97	5.28	SÍ	SÍ	1517	213
85334	EB3	EB3	1-5/8"	D	14.5	10.47	4.03	SÍ	SÍ	1271	319
85912	EB3	ES36	1-5/8"	G	18.68	12.57	6.11	SÍ	SÍ	1020	219
85327	EB3	ES160	1-5/8"	D	16.01	12.1	3.91	SÍ	SÍ	764	162
85322	EB3	ES160	1-5/8"	D	15.26	11.85	3.41	SÍ	SÍ	764	162
83353	EB3	S21	1-3/8"	B	24.84	15.06	9.78	SÍ	NO	432	214
85740	EB3	S21	1-5/8"	D	24.7	15.15	9.55	SÍ	SÍ	848	305
85380	EB3	S21	1-5/8"	D	23.95	14.79	9.15	SÍ	SÍ	1568	227
85312	EB3	S21	1-5/8"	D	23.69	14.85	8.84	SÍ	SÍ	717	111
85733	EB3	S21	1-5/8"	D	23.57	14.73	8.84	SÍ	SÍ	717	111
85379	EB3	S21	1-5/8"	D	22.69	14.4	8.29	SÍ	SÍ	1658	176
85330	EB3	S21	1-5/8"	D	22.44	14.16	8.28	SÍ	SÍ	1140	176
85729	EB3	S21	1-5/8"	D	21.58	13.8	7.78	SÍ	SÍ	783	111
85723	EB3	S21	1-5/8"	D	19.94	12.91	7.03	SÍ	SÍ	1318	248
82615	EB4	BP11			15.69	10.43	5.26				
83117	EB4	EB1	1-3/8"	A	23.94	14.45	9.49	SÍ	NO	354	300
82046	EB4	EB4			26.04	15.43	10.61				
82054	EB4	EB4			24.54	14.68	9.86				
81469	EB4	EB4			22.54	13.68	8.86				
49110	EB4	EB4			22.08	13.85	8.23				
58183	EB4	EB4			21.18	13.3	7.88				
81825	EB4	EB4			21.1	12.99	8.11				
61632	EB4	EB4			20.79	13.01	7.78				
G63183	EB4	EB4			20.79	13.01	7.78				
82065	EB4	EB4			19.04	11.93	7.11				
43085	EB4	ES27			20.61	12.78	7.83				
83119	EB4	ES165	1-3/8"	A	23.96	14.84	9.12	SÍ	NO	354	300
61575	EB5	ES24			21.14	13.36	7.78				
G63626	EB5	ES24			21.14	13.36	7.78				
G63683	EB5	ES24			21.14	13.36	7.78				
77683	EB5	ES24			21.11	13.27	7.84				

\* Damping force, in pounds, to either extend or collapse the shock absorber at an average operating velocity. Fuerza de amortiguación en libras para extender o comprimir el amortiguador a una velocidad de operación promedio. La puissance d'amortissement en poids de l'amortisseur, soit comprimé, doit détendu, à une vitesse de fonctionnement moyenne.

‡ For GasSLX Series, forces are at the "Firm" (F) setting. / Para la serie GasSLX, las fuerzas están ajustadas en (F) "Firme". / Pour la série GasSLX, le réglage de la force est sur «Ferme» (F).

## ESPECIFICACIONES POR TIPO DE MONTAJE

GRC	Montajes		Calibre de Pistón	Imagen de Diámetro Exterior	Longitudes [in]			Polvera	Tope Hidráulico	Fuerza*	
	Superior	Inferior			Extendido	Comprimido	Carrera			Rebote	Compresión
81891	EB5	ES24			21.09	13.33	7.76				
81583	EB5	ES25			18.39	11.53	6.86				
61541	EB5	ES25			18.14	11.61	6.53				
83303	EB7	ES36	1-3/8"	B	24.86	15.08	9.78	SÍ	NO	470	122
83304	EB7	ES36	1-3/8"	B	22.86	14.08	8.78	SÍ	NO	470	122
58355	EB11	ES24			14.87	10.11	4.76				
G64028	EB16	ES113			20.75	13.19	7.56				
G63494	EB19	EB19			22.39	13.86	8.53				
G63510	EB19	EB19			21.29	13.26	8.03				
G63605	EB19	ES27			24.24	14.71	9.53				
81909	EB19	ES48			19.63	12.27	7.36				
G63639	EB19	ES69			24.16	14.63	9.53				
81907	EB19	ES69			24.14	14.53	9.61				
G63434	EB19	S32			22.68	13.9	8.78				
61690	EB20	EB20			24.78	15.84	8.94				
83065	ES	ES171	1-5/8"	G	12.52	9.32	3.2	SÍ	SÍ	680‡	184
69416	ES3	ES56			20.15	13.45	6.70				
82079	ES9	BP20			15.54	9.93	5.61				
69622	ES10	EB1			14.73	9.62	5.11				
81880	ES10	EB1			14.73	9.62	5.11				
49304	ES10	EB1			14.35	9.75	4.60				
83002	ES10	ES10	1-3/8"	A	11.61	8.62	3	SÍ	SÍ	3112	590
83024	ES10	ES10	1-3/8"	2-1/2" D/T	11.61	8.62	2.99	SÍ	SÍ	811	320
83016	ES10	ES10	1"	1-5/8"	11.51	8.14	3.37	NO	SÍ	506	139
83031	ES10	ES10	1-3/8"	2-1/2" D/T	11.49	8.62	2.87	SÍ	SÍ	811	314
83051	ES10	ES10	1-3/8"	2-1/2" D/T	9.41	7.4	2.01	SÍ	SÍ	579	163
83061	ES10	ES10	1-3/8"	2-1/2" D/T	9.41	7.4	2.01	SÍ	SÍ	1030	220
83021	ES10	ES10	1-3/8"	A	9.36	7.37	1.99	SÍ	SÍ	745	315
83046	ES10	ES181	1-3/16"		9.23†	7.62†	2.73	NO	SÍ	514	173
83023	ES10	ES181	1"	1-5/8"	8.7	7.09†	2.14	NO	SÍ	484	157
82089	ES12	EB1			22.23	13.37	8.86				
G63875	ES13	ES13			17.67	11.73	5.94				
49307	ES17	ES17			16.35	10.75	5.60				
83043	ES17	ES17	1-3/16"	2" D/T	8.51	6.51	2	SÍ	NO	223	157
61720	ES17	ES19			15.92	11.23	4.69				
49215	ES18	ES18			23.02	14.16	8.86				
43161	ES18	ES18			22.3	13.69	8.61				
69858	ES18	ES18			21.23	12.87	8.36				
G63426	ES18	ES18			18.01	11.48	6.53				
G63690	ES18	ES18			18.01	11.48	6.53				
61538	ES18	ES18			17.98	11.45	6.53				
61605	ES18	ES18			17.98	11.45	6.53				
49236	ES18	ES18			17.77	11.54	6.23				

\* Damping force, in pounds, to either extend or collapse the shock absorber at an average operating velocity. Fuerza de amortiguación en libras para extender o comprimir el amortiguador a una velocidad de operación promedio. La puissance d'amortissement en poids de l'amortisseur, soit comprimé, soit détendu, à une vitesse de fonctionnement moyenne.

† At bumper contact / Al contacto con el tope de goma / Au contact avec le butoir

‡ For GasSLX Series, forces are at the "Firm" (F) setting. / Para la serie GasSLX, las fuerzas están ajustadas en (F) "Firme". / Pour la série GasSLX, le réglage de la force est sur «Ferme» (F).

## ESPECIFICACIONES POR TIPO DE MONTAJE

GRC	Montajes		Calibre de Pistón	Imagen de Diámetro Exterior	Longitudes [in]			Polvera	Tope Hidráulico	Fuerza*	
	Superior	Inferior			Extendido	Comprimido	Carrera			Rebote	Compresión
81529	ES18	ES18			17.73	11.12	6.61				
81878	ES18	ES18			17.73	11.12	6.61				
82031	ES18	ES18			16.23	10.37	5.86				
G64042	ES18	ES18			14.92	10.55	4.37				
69616	ES18	ES19			16.63	10.87	5.76				
49345	ES18	ES21			22.6	15.16	7.44				
69760	ES18	ES79			16.26	12.6	3.66				
69715	ES18	ES110			13.98	9.37	4.61				
G63842	ES18	ES126			23.33	14.8	8.53				
G64016	ES19	ES17			15.91	11.22	4.69				
69587	ES19	ES56			15.9	10.64	5.26				
69589	ES19	ES59			17.54	11.53	6.01				
G63892	ES19	ES87			23.97	15.28	8.69				
81910	ES19	ES110			22.48	13.62	8.86				
83045	ES19	S10	1-3/8"	A	11.53†	8.58†	3.81	SÍ	NO	510	153
83050	ES19	S10	1-3/8"	A	10.43†	8.38†	2.9	SÍ	SÍ	599	321
83058	ES19	S10	1-3/8"	A	10.43†	8.38†	2.9	SÍ	SÍ	742	243
83158	ES22	ES22	1-3/8"	A	12.96	8.97	4	SÍ	NO	783	484
58394	ES24	EB1			15.68	10.56	5.12				
82035	ES24	EB1			14.64	9.53	5.11				
82062	ES24	ES24			24.23	14.37	9.86				
G63371	ES24	ES24			21.98	13.45	8.53				
82006	ES24	ES24			20.48	12.62	7.86				
43093	ES24	ES24			20.2	12.62	7.58				
49162	ES24	ES24			20.02	12.79	7.23				
G63306	ES24	ES24			19.85	12.57	7.28				
49107	ES24	ES24			19.27	12.29	6.98				
43062	ES24	ES24			18.95	11.87	7.08				
82003	ES24	ES24			18.55	11.44	7.11				
61517	ES24	ES24			14.98	9.95	5.03				
G63357	ES24	ES24			14.98	9.95	5.03				
77357	ES24	ES24			14.85	9.86	4.99				
58357	ES24	ES24			14.68	10.06	4.62				
83022	ES24	ES24	1"	2" D/T	14.28	9.33	4.95	SÍ	NO	840	152
81108	ES24	ES24			14.23	9.37	4.86				
83010	ES24	ES24	1"	2" D/T	14.15†	9.33	5.07	SÍ	SÍ	188	70
83026	ES24	ES24	1-3/8"	A	13.11	9.12	3.99	SÍ	SÍ	602	104
83027	ES24	S10	1-3/8"	A	13.8	9.18	4.62	SÍ	SÍ	602	104
83018	ES24	S10	1-3/8"	A	10.3†	8.42†	3.24	SÍ	SÍ	515	174
83019	ES24	S10	1-3/8"	A	9.42	8.16†	2.28	SÍ	SÍ	509	121
82033	ES25	EB19			18.79	12.03	6.76				
58456	ES25	ES25			26.68	16.06	10.62				
77717	ES25	ES25			22.92	13.9	9.02				

\* Damping force, in pounds, to either extend or collapse the shock absorber at an average operating velocity. Fuerza de amortiguación en libras para extender o comprimir el amortiguador a una velocidad de operación promedio. La puissance d'amortissement en poids de l'amortisseur, soit comprimé, soit détendu, à une vitesse de fonctionnement moyenne.

† At bumper contact / Al contacto con el tope de goma / Au contact avec le butoir

## ESPECIFICACIONES POR TIPO DE MONTAJE

GRC	Montajes		Calibre de Pistón	Imagen de Diámetro Exterior	Longitudes [in]			Polvera	Tope Hidráulico	Fuerza*	
	Superior	Inferior			Extendido	Comprimido	Carrera			Rebote	Compresión
58717	ES25	ES25			22.87	13.99	8.88				
G63502	ES25	ES141			18.51	11.98	6.53				
49106	ES26	EB4			22.43	13.95	8.48				
G63403	ES26	ES26			24.58	14.8	9.78				
58403	ES26	ES26			24.48	14.95	9.53				
61658	ES26	ES26			24.48	14.7	9.78				
81923	ES26	ES26			24.47	14.61	9.86				
77403	ES26	ES26			24.31	14.78	9.53				
G63671	ES26	ES26			22.48	13.7	8.78				
58671	ES26	ES26			22.2	13.67	8.53				
G63423	ES26	ES26			16.76	10.73	6.03				
61531	ES26	ES26			16.73	10.7	6.03				
81516	ES26	ES26			16.73	10.62	6.11				
58423	ES26	ES26			16.45	10.67	5.78				
81342	ES27	EB4			28.89	16.78	12.11				
G63389	ES27	EB4			28.74	16.96	11.78				
61633	ES27	EB4			28.64	16.86	11.78				
81091	ES27	EB4			25.14	15.28	9.86				
49149	ES27	EB4			24.93	15.64	9.29				
G63353	ES27	EB4			24.74	14.96	9.78				
61526	ES27	EB4			24.64	14.86	9.78				
43067	ES27	EB4			24.61	14.78	9.83				
58353	ES27	EB4			24.52	14.9	9.62				
43096	ES27	EB4			22.61	13.78	8.83				
82131	ES27	EB4			22.39	13.53	8.86				
69787	ES27	ES19			17.79	11.53	6.26				
58389	ES27	ES27			29.02	17.15	11.87				
49212	ES27	ES27			21.02	13.29	7.73				
77413	ES27	ES27			20.86	13.01	7.85				
G63413	ES27	ES27			20.76	12.98	7.78				
58413	ES27	ES27			20.68	13.06	7.62				
61522	ES27	ES27			20.49	12.63	7.86				
81496	ES27	ES27			20.49	12.63	7.86				
G63906	ES27	ES27			20.49	12.63	7.86				
58906	ES27	ES27			19.98	12.7	7.28				
83044	ES27	ES164	1-3/8"	A	10.91	7.93	2.98	Sí	Sí	789	296
43138	ES27	S12			18.18	11.1	7.08				
49346	ES27	S12			18.08	11.48	6.60				
69703	ES27	S12			17.95	11.09	6.86				
81338	ES27	S12			17.95	11.09	6.86				
G64050	ES30	ES137			19.55	12.91	6.65				
G63437	ES31	ES24			23.33	14.05	9.28				
58437	ES31	ES24			22.99	14.09	8.90				

\* Damping force, in pounds, to either extend or collapse the shock absorber at an average operating velocity. Fuerza de amortiguación en libras para extender o comprimir el amortiguador a una velocidad de operación promedio. La puissance d'amortissement en poids de l'amortisseur, soit comprimé, doit détendu, à une vitesse de fonctionnement moyenne.

## ESPECIFICACIONES POR TIPO DE MONTAJE

GRC	Montajes		Calibre de Pistón	Imagen de Diámetro Exterior	Longitudes [in]			Polvera	Tope Hidráulico	Fuerza*	
	Superior	Inferior			Extendido	Comprimido	Carrera			Rebote	Compresión
61516	ES31	ES24			18.23	11.37	6.86				
81113	ES31	ES24			18.23	11.37	6.86				
G63908	ES31	ES24			18.23	11.37	6.86				
58908	ES31	ES24			18.2	11.67	6.53				
43107	ES31	ES24			17.95	11.37	6.58				
58347	ES31	ES24			17.87	11.49	6.38				
58411	ES31	ES26			18.68	12.06	6.62				
G63411	ES31	ES26			18.58	11.8	6.78				
G63347	ES31	ES35			18.08	11.55	6.53				
G64031	ES34	EB1			21.19	13.5	7.69				
G63878	ES34	ES13			24.16	14.97	9.19				
G63883	ES34	ES13			22.82	14.38	8.44				
61709	ES34	ES34			27.58	17.14	10.44				
61710	ES34	ES34			27.58	17.14	10.44				
G63970	ES34	ES34			27.58	17.14	10.44				
G63971	ES34	ES34			27.58	17.14	10.44				
77950	ES34	ES34			27.5	17.5	10.00				
G64000	ES34	ES34			27.36	17.68	9.68				
G63675	ES34	ES34			26.86	16.08	10.78				
77412	ES34	ES34			26.77	16.26	10.51				
61642	ES34	ES34			26.76	15.98	10.78				
81921	ES34	ES34			26.76	15.67	11.09				
58412	ES34	ES34			26.68	16.18	10.50				
81931	ES34	ES34			26.53	16.02	10.51				
G64013	ES34	ES34			26.52	16.33	10.19				
61691	ES34	ES34			26.51	16.12	10.39				
G63961	ES34	ES34			26.51	16.12	10.39				
61716	ES34	ES34			26.5	16.33	10.17				
77675	ES34	ES34			26.25	15.74	10.51				
58675	ES34	ES34			26.13	15.87	10.26				
61692	ES34	ES34			26.05	15.87	10.18				
G63962	ES34	ES34			26.05	15.87	10.18				
G63959	ES34	ES34			24.78	15.84	8.94				
49235	ES34	ES34			24.77	15.04	9.73				
81873	ES34	ES34			24.74	14.88	9.86				
58662	ES34	ES34			24.68	15.36	9.32				
G63662	ES34	ES34			24.58	15.05	9.53				
61600	ES34	ES34			24.51	14.98	9.53				
77662	ES34	ES34			24.31	14.78	9.53				
43181	ES34	ES34			24.24	14.88	9.36				
61649	ES34	ES34			23.26	14.23	9.03				
G63366	ES34	ES34			23.26	14.23	9.03				
81174	ES34	ES34			23.23	13.87	9.36				

\* Damping force, in pounds, to either extend or collapse the shock absorber at an average operating velocity. Fuerza de amortiguación en libras para extender o comprimir el amortiguador a una velocidad de operación promedio. La puissance d'amortissement en poids de l'amortisseur, soit comprimé, doit détendu, à une vitesse de fonctionnement moyenne.

## ESPECIFICACIONES POR TIPO DE MONTAJE

GRC	Montajes		Calibre de Pistón	Imagen de Diámetro Exterior	Longitudes [in]			Polvera	Tope Hidráulico	Fuerza*	
	Superior	Inferior			Extendido	Comprimido	Carrera			Rebote	Compresión
58366	ES34	ES34			23.18	14.3	8.88				
43111	ES34	ES34			22.9	13.82	9.08				
58930	ES34	ES34			22.81	14.06	8.75				
61675	ES34	ES34			22.81	14.12	8.69				
81930	ES34	ES34			22.81	13.95	8.86				
G63866	ES34	ES34			22.81	14.12	8.69				
77953	ES34	ES34			22.65	13.9	8.75				
83153	ES34	ES34	1-3/8"	A	21.69	13.62	8.07	SÍ	SÍ	974	206
83155	ES34	ES34	1-3/8"	A	21.69	13.62	8.07	SÍ	SÍ	507	80
82010	ES34	ES34			16.63	12.47	4.16				
G63918	ES34	ES141			21.25	13.56	7.69				
14019	ES35	EB1			26.87	15.55	11.32				
14018	ES35	EB1			21.37	12.8	8.57				
82086	ES35	ES35			25.54	14.93	10.61				
14010	ES35	ES35			16.77	10.45	6.32				
83059	ES35	ES35	1-3/8"	A	12.06†	8.68	3.88	SÍ	SÍ	738	350
83004	ES35	ES136	1"	2" D/T	9.36†	7.29	2.32	SÍ	SÍ	539	324
85905	ES36	EB3	1-5/8"	G	23.81	16.16	7.66	SÍ	SÍ	1020	219
85913	ES36	EB3	1-5/8"	G	22.56	15.2	7.36	SÍ	SÍ	1020	219
85057	ES36	EB3	1-5/8"	C	21.45	14.23	7.22	SÍ	SÍ	1216	115
85907	ES36	EB3	1-5/8"	G	21.43	14.2	7.23	SÍ	SÍ	1216	251
83113	ES36	EB3	1-3/8"	A	20.42	13.43	6.99	SÍ	SÍ	997	238
85059	ES36	EB3	1-5/8"	C	19.07	12.79	6.28	SÍ	SÍ	928	151
85915	ES36	EB3	1-5/8"	G	19.06	12.7	6.36	SÍ	SÍ	1020	219
83115	ES36	EB3	1-3/8"	A	16.19	13.32	4.87	SÍ	SÍ	997	238
83242	ES36	ES36	1-3/8"	A	33.73	20.98	12.75	SÍ	SÍ	721	135
85903	ES36	ES36	1-5/8"	G	31.99	19.13	12.86	SÍ	SÍ	666	113
85979	ES36	ES36	1-5/8"	G	31.17	18.66	12.52	SÍ	SÍ	582	138
85972	ES36	ES36	1-5/8"	G	30.78	18.26	12.52	SÍ	NO	1493	261
83121	ES36	ES36	1-3/8"	A	30.25	18.32	11.93	SÍ	SÍ	689	126
83137	ES36	ES36	1-3/8"	A	30.03	17.78	12.25	SÍ	SÍ	517	132
85976	ES36	ES36	1-5/8"	G	29.91	18.13	11.79	SÍ	SÍ	582	138
85013	ES36	ES36	1-5/8"	C	29.74	17.71	12.03	SÍ	SÍ	1019	219
83205	ES36	ES36	1-3/8"	A	29.69	17.69	12	SÍ	SÍ	660	76
83209	ES36	ES36	1-3/8"	A	29.64	17.61	12.03	SÍ	SÍ	670	78
89414	ES36	ES36	1-5/8"	G	29.62	18.04	11.58	SÍ	SÍ	1045‡	217
85337	ES36	ES36	1-5/8"	D	28.72	17.45	11.28	SÍ	SÍ	1318	374
85006	ES36	ES36	1-5/8"	C	28.5	17.09	11.41	SÍ	SÍ	1019	219
83125	ES36	ES36	1-3/8"	A	28.12	17.13	10.99	SÍ	SÍ	625	115
85097	ES36	ES36	1-5/8"	C	27.95	17.11	10.84	SÍ	SÍ	1086	109
85043	ES36	ES36	1-5/8"	C	27.63	16.85	10.78	SÍ	SÍ	628	163
85904	ES36	ES36	1-5/8"	G	27.61	16.88	10.73	SÍ	SÍ	666	113
85010	ES36	ES36	1-5/8"	C	26.74	16.21	10.53	SÍ	SÍ	1019	219

\* Damping force, in pounds, to either extend or collapse the shock absorber at an average operating velocity. Fuerza de amortiguación en libras para extender o comprimir el amortiguador a una velocidad de operación promedio. La puissance d'amortissement en poids de l'amortisseur, soit comprimé, soit détendu, à une vitesse de fonctionnement moyenne.

† At bumper contact / Al contacto con el tope de goma / Au contact avec le butoir

‡ For GasSLX Series, forces are at the "Firm" (F) setting. / Para la serie GasSLX, las fuerzas están ajustadas en (F) "Firme". / Pour la série GasSLX, le réglage de la force est sur «Firme» (F).

## ESPECIFICACIONES POR TIPO DE MONTAJE

GRC	Montajes		Calibre de Pistón	Imagen de Diámetro Exterior	Longitudes [in]			Polvera	Tope Hidráulico	Fuerza*	
	Superior	Inferior			Extendido	Comprimido	Carrera			Rebote	Compresión
83123	ES36	ES36	1-3/8"	A	26.62	16.38	10.24	SÍ	SÍ	589	119
83176	ES36	ES36	1-3/8"	A	26.62	15.96	10.66	NO	NO	406	275
85036	ES36	ES36	1-5/8"	C	26.38	16.29	10.09	SÍ	SÍ	633	119
89405	ES36	ES36	1-5/8"	G	26.24	16.41	9.83	SÍ	SÍ	1009‡	249
85099	ES36	ES36	1-5/8"	C	26.02	15.93	10.09	SÍ	SÍ	1152	135
85974	ES36	ES36	1-5/8"	G	26.02	16.11	9.91	SÍ	SÍ	3087	230
85321	ES36	ES36	1-5/8"	D	25.36	15.58	9.78	SÍ	SÍ	1435	676
83149	ES36	ES36	1-3/8"	A	25.28	15.78	9.49	SÍ	SÍ	332	101
83122	ES36	ES36	1-3/8"	A	25.24	15.75	9.49	SÍ	SÍ	661	201
83218	ES36	ES36	1-3/8"	A	25.19	15.44	9.75	SÍ	SÍ	721	194
665472	ES36	ES36	1-5/8"	G	25.14	15.61	9.53	NO	NO	925	977
85005	ES36	ES36	1-5/8"	C	24.74	15.21	9.53	SÍ	SÍ	1019	219
89406	ES36	ES36	1-5/8"	G	24.74	15.66	9.08	SÍ	SÍ	658‡	125
85916	ES36	ES36	1-5/8"	G	24.61	15.51	9.11	SÍ	SÍ	1149	219
89430	ES36	ES36	1-5/8"	G	24.6	15.39	9.53	SÍ	SÍ	1462‡	279
83126	ES36	ES36	1-3/8"	A	24.37	15.25	9.12	SÍ	SÍ	625	115
85909	ES36	ES36	1-5/8"	G	24.24	15.13	9.11	SÍ	SÍ	700	255
85975	ES36	ES36	1-5/8"	G	24.24	15.15	9.09	SÍ	SÍ	1658	219
83310	ES36	ES36	1-3/8"	B	24.06	14.69	9.37	SÍ	NO	559	153
83221	ES36	ES36	1-3/8"	A	24.01	14.73	9.28	SÍ	NO	599	153
85030	ES36	ES36	1-5/8"	C	24	14.84	9.16	SÍ	SÍ	1019	219
89440	ES36	ES36	1-5/8"	G	23.86	15.16	8.7	SÍ	SÍ	1498‡	561
83144	ES36	ES36	1-3/8"	A	23.78	15.03	8.75	SÍ	SÍ	596	93
89432	ES36	ES36	1-5/8"	G	23.41	14.66	8.75	SÍ	NO	1507‡	561
85050	ES36	ES36	1-5/8"	C	23.28	14.5	9.03	SÍ	NO	525	138
665937	ES36	ES36	1-5/8"	G	22.91	16.09	6.82	SÍ	NO		
85044	ES36	ES36	1-5/8"	C	22.63	14.1	8.53	SÍ	NO	722	212
85058	ES36	ES36	1-5/8"	C	22.63	14.22	8.41	SÍ	SÍ	722	114
85971	ES36	ES36	1-5/8"	G	22.55	14.17	8.38	SÍ	NO	2315	451
85919	ES36	ES36	1-5/8"	G	22.48	14.25	8.23	SÍ	SÍ	1265	121
632155	ES36	ES36	1-3/16"		22.45	14.1	8.35	NO	NO		
646155	ES36	ES36	1-3/16"		22.45	14.1	8.35	SÍ	NO		
646177	ES36	ES36	1-3/16"		22.45	14.1	8.35	NO	NO		
89431	ES36	ES36	1-5/8"	G	22.41	14.16	8.25	SÍ	NO	751‡	211
85345	ES36	ES36	1-5/8"	D	21.83	13.82	8.01	SÍ	SÍ	1093	219
85014	ES36	ES36	1-5/8"	C	21.74	13.71	8.03	SÍ	SÍ	1019	219
85906	ES36	ES36	1-5/8"	G	21.73	14	7.73	SÍ	SÍ	700	255
83124	ES36	ES36	1-3/8"	A	21.65	13.75	7.87	SÍ	SÍ	750	137
83207	ES36	ES36	1-3/8"	A	21.64	13.61	8.03	SÍ	SÍ	553	143
89407	ES36	ES36	1-5/8"	G	21.62	14.04	7.58	SÍ	SÍ	652‡	218
85091	ES36	ES36	1-5/8"	C	21.38	13.56	7.82	SÍ	NO	1121	331
85910	ES36	ES36	1-5/8"	G	20.73	13.5	7.23	SÍ	SÍ	1074	219
85029	ES36	ES36	1-5/8"	C	20.5	13.09	7.41	SÍ	SÍ	1019	219

\* Damping force, in pounds, to either extend or collapse the shock absorber at an average operating velocity. Fuerza de amortiguación en libras para extender o comprimir el amortiguador a una velocidad de operación promedio. La puissance d'amortissement en poids de l'amortisseur, soit comprimé, doit détendu, à une vitesse de fonctionnement moyenne.

‡ For GasSLX Series, forces are at the "Firm" (F) setting. / Para la serie GasSLX, las fuerzas están ajustadas en (F) "Firme". / Pour la série GasSLX, le réglage de la force est sur «Firme» (F).



## ESPECIFICACIONES POR TIPO DE MONTAJE

GRC	Montajes		Calibre de Pistón	Imagen de Diámetro Exterior	Longitudes [in]			Polvera	Tope Hidráulico	Fuerza*	
	Superior	Inferior			Extendido	Comprimido	Carrera			Rebote	Compresión
85382	ES36	ES36	1-5/8"	D	20.22	13.07	7.15	SÍ	SÍ	1658	420
83204	ES36	ES36	1-3/8"	A	20.14	12.86	7.28	SÍ	SÍ	451	110
83127	ES36	ES36	1-3/8"	A	20.12	13.13	6.99	SÍ	SÍ	940	218
89437	ES36	ES36	1-5/8"	G	20.12	13.29	6.83	SÍ	SÍ	1155‡	514
85060	ES36	ES36	1-5/8"	C	19.75	12.72	7.03	SÍ	SÍ	943	405
85338	ES36	ES36	1-5/8"	D	19.47	12.7	6.77	SÍ	SÍ	1664	420
85051	ES36	ES36	1-5/8"	C	18.53	12.15	6.4	SÍ	SÍ	1019	139
85908	ES36	ES36	1-5/8"	G	18.48	12.25	6.23	SÍ	SÍ	1020	219
83130	ES36	ES36	1-3/8"	A	18.03	12.04	5.99	SÍ	SÍ	871	177
85934	ES36	ES36	1-5/8"	G	17.73	12	5.73	SÍ	SÍ	3511	1063
85086	ES36	ES36	1-5/8"	C	17.55	11.63	5.92	SÍ	SÍ	2027	389
85738	ES36	ES36	1-5/8"	D	17.47	11.7	5.77	SÍ	SÍ	1830	416
85323	ES36	ES36	1-5/8"	D	17.36	11.58	5.78	SÍ	SÍ	1085	163
87018	ES36	ES36	2-1/16"	E	17.36	11.71	5.65	SÍ	SÍ	2479	1000
89436	ES36	ES36	1-5/8"	G	17.24	11.91	5.33	SÍ	SÍ	998‡	217
85000	ES36	ES36	1-5/8"	C	17.22	11.46	5.76	SÍ	SÍ	1019	219
83203	ES36	ES36	1-3/8"	A	17.1	11.36	5.74	SÍ	SÍ	609	114
83128	ES36	ES36	1-3/8"	A	16.87	11.51	5.37	SÍ	SÍ	940	218
85911	ES36	ES36	1-5/8"	G	16.86	11.5	5.36	SÍ	SÍ	1020	219
85938	ES36	ES36	1-5/8"	G	16.06	10.78	5.28	SÍ	SÍ	1581	432
85064	ES36	ES36	1-5/8"	C	16.03	10.76	5.27	SÍ	SÍ	1481	340
83150	ES36	ES36	1-3/8"	A	15.24	10.43	4.81	SÍ	SÍ	940	216
85078	ES36	ES36	1-5/8"	C	14.77	10.13	4.64	SÍ	SÍ	1409	282
85045	ES36	ES36	1-5/8"	C	14.51	10.1	4.41	SÍ	SÍ	1020	219
85939	ES36	ES36	1-5/8"	G	14.44	10.03	4.41	SÍ	SÍ	1719	420
85914	ES36	ES36	1-5/8"	G	14.36	10.25	4.11	SÍ	SÍ	1020	219
85052	ES36	ES36	1-5/8"	C	13.25	9.47	3.78	SÍ	SÍ	1019	139
85344	ES36	ES36	1-5/8"	D	13.22	9.45	3.77	SÍ	SÍ	1581	443
85079	ES36	ES36	1-5/8"	C	12.04	8.87	3.17	SÍ	SÍ	1494	325
83157	ES36	ES90	1-3/8"	A	26.38	15.76	10.61	SÍ	NO	446	303
85102	ES36	ES136	1-5/8"	C	21.53	14.94	6.59	SÍ	SÍ	1224	342
83164	ES36	ES165	1-3/8"	C	24.22	14.59	9.63	SÍ	NO	426	274
85072	ES36	ES176	1-5/8"	C	24.17	14.83	9.34	SÍ	SÍ	1387	305
85087	ES36	ES176	1-5/8"	C	22.79	14.71	8.08	SÍ	SÍ	1568	403
85109	ES36	ES195	1-5/8"	C	24.21	15.14	9.07	SÍ	SÍ	1123	149
83635	ES36	S21	1-3/8"	A	21.74	13.25	8.49	SÍ	NO	558	119
85977	ES36	S42	1-5/8"	G	26.2	15.91	10.29	SÍ	SÍ	582	138
83109	ES36	S42	1-3/8"	A	26.14	15.9	10.24	SÍ	SÍ	345	78
83111	ES36	S42	1-3/8"	A	26.14	15.9	10.24	SÍ	SÍ	560	141
83138	ES36	S42	1-3/8"	A	23.55	14.42	9.12	SÍ	SÍ	997	231
83110	ES36	S42	1-3/8"	A	22.89	14.27	8.62	SÍ	SÍ	450	143
83112	ES36	S42	1-3/8"	A	21.52	13.4	8.12	SÍ	SÍ	1064	343
58808	ES41	ES41			28.38	16.75	11.63				

\* Damping force, in pounds, to either extend or collapse the shock absorber at an average operating velocity. Fuerza de amortiguación en libras para extender o comprimir el amortiguador a una velocidad de operación promedio. La puissance d'amortissement en poids de l'amortisseur, soit comprimé, soit détendu, à une vitesse de fonctionnement moyenne.

‡ For GasSLX Series, forces are at the "Firm" (F) setting. / Para la serie GasSLX, las fuerzas están ajustadas en (F) "Firme". / Pour la série GasSLX, le réglage de la force est sur «Firme» (F).

## ESPECIFICACIONES POR TIPO DE MONTAJE

GRC	Montajes		Calibre de Pistón	Imagen de Diámetro Exterior	Longitudes [in]			Polvera	Tope Hidráulico	Fuerza*	
	Superior	Inferior			Extendido	Comprimido	Carrera			Rebote	Compresión
81821	ES41	ES41			23.23	13.87	9.36				
61614	ES41	ES41			22.98	13.95	9.03				
G63455	ES41	ES41			22.98	13.95	9.03				
G63717	ES41	ES41			22.98	13.95	9.03				
58455	ES41	ES41			22.87	13.99	8.88				
G63869	ES41	ES41			20.26	12.82	7.44				
14039	ES41	ES41			15.73	12.12	3.51				
G64040	ES42	ES50			15.9	11.1	4.8				
82030	ES43	ES43			20.23	12.37	7.86				
69885	ES43	ES43			17.63	11.37	6.26				
81555	ES44	ES1			16.13	10.62	5.51				
G64015	ES45	ES128			21.32	13.63	7.69				
61717	ES47	ES26			22.75	14.56	8.19				
G64014	ES47	ES45			22.75	14.56	8.19				
G63708	ES48	EB19			19.74	12.46	7.28				
G64044	ES49	ES49			25.98	16.22	9.76				
G64032	ES49	ES49			18.7	12.09	6.61				
G64033	ES51	ES51			14.72	10.36	4.36				
83033	ES53	ES53	1-3/8"	A	13.99	10.37	3.62	Sí	Sí	494	312
14071	ES53	ES65			20.7	12.79	7.91				
G63919	ES58	ES153			21.25	13.56	7.69				
6848SE	ES62	ES109			18.04	11.18	6.86				
81554	ES64	EB1			18.48	11.62	6.86				
82032	ES64	ES64			22.73	13.87	8.86				
82001	ES64	ES64			15.98	10.37	5.61				
81557	ES64	ES112			16.29	10.93	5.36				
6846SE	ES65	ES65			22.6	13.68	8.92				
82076	ES66	S1			18.7	11.34	7.36				
69782	ES67	ES61			15.1	10.34	4.76				
G63864	ES67	ES61			15	10.56	4.44				
81741	ES69	ES4			18.31	13.64	4.67				
G64080	ES69	ES33			21.57	17.72	3.85				
G63877	ES69	ES69			16.93	11.24	5.69				
61704	ES69	ES69			16.84	11.28	5.56				
G64003	ES69	ES69			16.84	11.28	5.56				
69909	ES69	ES69			16.63	10.88	5.75				
49233	ES69	ES69			15.67	10.79	4.88				
81882	ES69	ES69			15.63	10.37	5.26				
61625	ES69	ES69			15.48	10.45	5.03				
G63676	ES69	ES69			15.48	10.45	5.03				
43173	ES69	ES69			15.39	10.38	5.01				
69805	ES71	ES71			18.19	11.93	6.26				
69417	ES71	ES121			18.25	11.99	6.26				

\* Damping force, in pounds, to either extend or collapse the shock absorber at an average operating velocity. Fuerza de amortiguación en libras para extender o comprimir el amortiguador a una velocidad de operación promedio. La puissance d'amortissement en poids de l'amortisseur, soit comprimé, soit détendu, à une vitesse de fonctionnement moyenne.

## ESPECIFICACIONES POR TIPO DE MONTAJE

GRC	Montajes		Calibre de Pistón	Imagen de Diámetro Exterior	Longitudes [in]			Polvera	Tope Hidráulico	Fuerza*	
	Superior	Inferior			Extendido	Comprimido	Carrera			Rebote	Compresión
G64026	ES73	ES73			16.26	11.57	4.69				
G64048	ES75	ES113			17.16	11.57	5.59				
83160	ES82	ES36	1-3/8"	A	24.31	14.9	9.37	SÍ	SÍ	920	161
83174	ES82	ES36	1-3/8"	A	24.31	14.9	9.37	SÍ	SÍ	795	160
G63867	ES82	ES82			27.31	16.37	10.94				
G63870	ES82	ES82			24.89	15.2	9.69				
G63873	ES82	ES82			15.75	10.56	5.19				
77837	ES83	BP14			28.73	16.92	11.81				
G63617	ES83	EB1			27.58	16.3	11.28				
G64079	ES83	ES83			29.37	17.32	12.05				
83131	ES83	ES83	1-3/8"	A	27.8	18.18	9.62	SÍ	NO	212	129
58617	ES83	ES83			27.37	16.24	11.13				
77455	ES83	ES83			22.92	13.9	9.02				
G64052	ES83	ES83			20.86	13.11	7.75				
61703	ES83	ES83			20.15	13.96	6.19				
G64002	ES83	ES83			20.15	13.96	6.19				
83145	ES83	ES83	1-3/8"	A	19.93	12.32	7.54	SÍ	NO	479	153
81793	ES84	ES84			22.78	13.67	9.11				
69808	ES84	ES84			22.74	13.63	9.11				
49369	ES84	ES84			21.86	13.51	8.35				
69632	ES84	ES84			21.78	13.42	8.36				
81459	ES84	ES84			21.73	13.37	8.36				
69473	ES85	ES30			18.29	11.43	6.86				
81739	ES85	ES64			16.23	10.87	5.36				
81464	ES85	ES64			15.63	10.37	5.26				
69689	ES85	ES85			15.63	10.37	5.26				
58812	ES86	EB20			22.45	14.07	8.38				
69706	ES86	ES34			13.46	9.95	3.51				
81445	ES86	ES34			13.46	9.95	3.51				
G63812	ES86	ES36			22.56	13.78	8.78				
83048	ES86	ES167	1-3/8"	A	9.97	8.43†	2.37	SÍ	SÍ	904	415
83028	ES86	ES167	1-3/8"	A	9.94	7.57	2.37	SÍ	SÍ	445	531
G63845	ES87	ES19			24.58	14.8	9.78				
G63844	ES87	ES19			22.52	13.74	8.78				
G63890	ES87	ES87			23.97	15.28	8.69				
G63891	ES87	ES87			23.97	15.28	8.69				
G63829	ES88	ES65			22.52	13.74	8.78				
77829	ES88	ES65			22.33	13.6	8.73				
61676	ES88	ES65			21.25	13.31	7.94				
81926	ES88	ES65			21.25	13.24	8.01				
61715	ES88	ES69			24.12	15.18	8.94				
G64012	ES88	ES69			24.11	15.17	8.94				
85963	ES90	ES36	1-5/8"	G	25.49	18.68	6.81	SÍ	SÍ	1490	206

\* Damping force, in pounds, to either extend or collapse the shock absorber at an average operating velocity. Fuerza de amortiguación en libras para extender o comprimir el amortiguador a una velocidad de operación promedio. La puissance d'amortissement en poids de l'amortisseur, soit comprimé, doit détendu, à une vitesse de fonctionnement moyenne.

† At bumper contact / Al contacto con el tope de goma / Au contact avec le butoir

## ESPECIFICACIONES POR TIPO DE MONTAJE

GRC	Montajes		Calibre de Pistón	Imagen de Diámetro Exterior	Longitudes [in]			Polvera	Tope Hidráulico	Fuerza*	
	Superior	Inferior			Extendido	Comprimido	Carrera			Rebote	Compresión
85964	ES90	ES36	1-5/8"	G	25.49	18.68	6.81	SÍ	SÍ	1981	205
85995	ES90	ES36	1-5/8"	G	23.5	14.52	8.98	SÍ	NO	1830	173
85994	ES90	ES36	1-5/8"	G	21.21	13.4	7.81	SÍ	NO	1824	263
85954	ES90	ES36	1-5/8"	G	20.43	12.96	7.46	SÍ	NO	1812	148
85924	ES90	ES36	1-5/8"	G	20.41	12.96	7.46	SÍ	NO	1036	122
89457	ES90	ES36	1-5/8"	G	19.95	12.71	6.97	SÍ	NO	941‡	156
85969	ES90	ES36	1-5/8"	G	18.38	11.93	6.45	SÍ	NO	1612	125
83146	ES90	ES83	1-3/8"	A	24.02	14.68	9.33	SÍ	SÍ	479	119
85082	ES90	ES90	1-5/8"	C	28.6	20.64	7.97	SÍ	SÍ	1435	266
83636	ES90	ES90	1-3/8"	A	27.72	16.95	10.77	SÍ	SÍ	505	148
83100	ES90	ES90	1-3/8"	A	26.6	16.11	10.49	SÍ	SÍ	481	142
85926	ES90	ES90	1-5/8"	G	26.48	17.96	8.53	SÍ	SÍ	1387	279
85953	ES90	ES90	1-5/8"	G	26.13	15.86	10.27	SÍ	NO	2001	153
85003	ES90	ES90	1-5/8"	C	25.37	15.59	9.78	SÍ	SÍ	437	182
89411	ES90	ES90	1-5/8"	G	25.36	15.59	9.78	SÍ	SÍ	436‡	186
85927	ES90	ES90	1-5/8"	G	24.74	15.38	9.36	SÍ	SÍ	1288	388
83101	ES90	ES90	1-3/8"	A	24.6	15.11	9.49	SÍ	SÍ	481	142
85998	ES90	ES90	1-5/8"	G	22.83	14.17	8.66	SÍ	NO	1345	178
85925	ES90	ES90	1-5/8"	G	22.54	15.59	6.96	SÍ	NO	761	144
85957	ES90	ES90	1-5/8"	G	20.78	13.15	7.63	SÍ	NO	1583	138
85928	ES90	ES90	1-5/8"	G	20.28	13.21	7.08	SÍ	NO	957	229
85929	ES90	ES90	1-5/8"	G	20.28	13.21	7.08	SÍ	NO	2214	267
85999	ES90	ES90	1-5/8"	G	19.84	12.79	7.05	SÍ	NO	2214	259
83167	ES90	ES90	1-3/8"	A	19.49	12.38	7.11	SÍ	NO	285	90
83135	ES90	ES90	1-3/8"	A	19.48	12.36	7.12	SÍ	NO	519	121
83156	ES90	ES90	1-3/8"	A	18.55	11.91	6.64	SÍ	NO	778	135
83169	ES90	ES90	1-3/8"	A	18.55	11.91	6.64	SÍ	NO	599	171
83020	ES91	ES91	1-3/8"	A	9.41	7.17	2.24	SÍ	SÍ	796	255
61608	ES99	ES48			19.64	12.36	7.28				
61597	ES104	ES69			24.14	14.61	9.53				
43165	ES106	ES106			22.99	13.88	9.11				
61609	ES110	ES19			22.48	13.7	8.78				
G63712	ES110	ES19			22.48	13.7	8.78				
83034	ES115	ES115	1-3/16"	1-5/8"	10.04†	7.32	2.97	NO	SÍ	430	129
83634	ES120	ES120	1-3/8"	A	27.48	16.23	11.25	SÍ	SÍ	779	157
85011	ES120	ES121	1-5/8"	C	27.49	16.46	11.03	SÍ	NO	1268	186
85096	ES120	S21	1-5/8"	C	25.31	16.23	9.08	SÍ	NO	1548	155
85122	ES120	S21	1-5/8"	C	22.22	13.78	8.44	SÍ	SÍ	926	162
83120	ES120	S21	1-3/8"	A	22.12	13.63	8.49	SÍ	SÍ	779	164
85123	ES120	S21	1-5/8"	C	21.49	13.26	8.23	SÍ	NO	1809	246
83154	ES120	S21	1-3/8"	A	20.78	12.72	8.06	SÍ	SÍ	599	140
85103	ES120	S42	1-5/8"	C	24.28	14.64	9.64	SÍ	NO	762	213
85108	ES121	ES121	1-5/8"	C	28.54	17.14	11.4	SÍ	SÍ	1617	148

\* Damping force, in pounds, to either extend or collapse the shock absorber at an average operating velocity. Fuerza de amortiguación en libras para extender o comprimir el amortiguador a una velocidad de operación promedio. La puissance d'amortissement en poids de l'amortisseur, soit comprimé, doit détendu, à une vitesse de fonctionnement moyenne.

† At bumper contact / Al contacto con el tope de goma / Au contact avec le butoir

‡ For GasSLX Series, forces are at the "Firm" (F) setting. / Para la serie GasSLX, las fuerzas están ajustadas en (F) "Firme". / Pour la série GasSLX, le réglage de la force est sur «Firme» (F).

## ESPECIFICACIONES POR TIPO DE MONTAJE

GRC	Montajes		Calibre de Pistón	Imagen de Diámetro Exterior	Longitudes [in]			Polvera	Tope Hidráulico	Fuerza*	
	Superior	Inferior			Extendido	Comprimido	Carrera			Rebote	Compresión
85095	ES121	ES121	1-5/8"	C	25.28	15.45	9.83	SÍ	NO	1653	119
58901	ES126	ES34			16.49	10.87	5.62				
58609	ES126	ES45			16.49	11.05	5.44				
61542	ES126	ES128			16.73	10.95	5.78				
G63818	ES126	ES128			16.51	10.98	5.53				
G63609	ES126	ES128			16.5	10.97	5.53				
81726	ES126	ES128			16.48	10.87	5.61				
77609	ES126	ES128			16.43	10.95	5.48				
61718	ES128	ES45			21.33	13.64	7.69				
G63872	ES128	ES128			21.65	13.29	8.36				
77423	ES128	ES128			16.8	10.83	5.97				
85100	ES136	ES136	1-5/8"	C	27.01	16.28	10.73	SÍ	NO	1036	264
83008	ES136	ES136	1-3/8"	A	12.98†	10.15†	3.99	SÍ	SÍ	699	307
83056	ES136	ES136	1-5/8"	C	11.53	8.63	2.89	SÍ	SÍ	3830	737
83042	ES136	ES136	1-3/8"	A	9.88†	8.44†	2.38	SÍ	SÍ	954	541
83030	ES136	ES136	1-3/8"	A	9.6†	7.61	2.49	SÍ	SÍ	308	87
85026	ES136	S21	1-5/8"	C	23	13.97	9.03	SÍ	NO	1079	539
89417	ES136	S21	1-5/8"	G	22.93	14.18	8.75	SÍ	NO	1226‡	515
81727	ES141	ES25			18.44	11.58	6.86				
61557	ES141	ES25			18.42	11.88	6.54				
49221	ES141	ES25			18.36	11.88	6.48				
61539	ES141	ES141			22.79	14.01	8.78				
G63454	ES141	ES141			22.79	14.01	8.78				
77454	ES141	ES141			22.77	14	8.77				
81581	ES141	ES141			22.54	13.68	8.86				
82151	ES145	ES70			23.23	13.87	9.36				
82103	ES145	S1			22.7	13.34	9.36				
83047	ES149	EB1	1-3/8"	A	11.78†	9.74†	3	SÍ	SÍ	364	314
83006	ES149	EB1	1-3/8"	A	10.66	8.48†	2.77	SÍ	SÍ	525	182
83001	ES149	EB1	1-3/8"	A	10.41†	8.36†	3	SÍ	SÍ	793	363
83038	ES149	EB1	1-3/8"	A	10.41†	8.36†	2.99	SÍ	SÍ	336	242
83017	ES149	ES149	1-3/8"	A	10.93	8.35†	3.13	SÍ	SÍ	353	138
83009	ES149	ES149	1-3/8"	A	10.41†	8.36†	2.99	SÍ	SÍ	793	363
83039	ES149	ES149	1-3/8"	A	10.41†	8.36†	2.99	SÍ	SÍ	876	326
83064	ES149	ES149	1-3/8"	A	10.41†	8.36†	2.99	SÍ	SÍ	635	323
85090	ES150	ES36	1-5/8"	C	25.31	15.52	9.78	SÍ	SÍ	943	99
89449	ES150	ES150	1-5/8"	G	23.09	14.71	8.38	SÍ	NO	1519‡	324
85918	ES150	ES150	1-5/8"	G	22.96	14.55	8.41	SÍ	NO	1726	412
85958	ES150	ES150	1-5/8"	G	22.96	14.55	8.41	SÍ	SÍ	1926	281
85106	ES150	ES150	1-5/8"	C	20.03	12.89	7.14	SÍ	SÍ	1054	109
85119	ES150	ES150	1-5/8"	C	21.39	13.81	7.68	SÍ	SÍ	1387	185
85920	ES150	ES150	1-5/8"	G	21.19	13.53	7.66	SÍ	NO	845	49
85922	ES150	ES150	1-5/8"	G	21.19	13.53	7.66	SÍ	NO	878	185

\* Damping force, in pounds, to either extend or collapse the shock absorber at an average operating velocity. Fuerza de amortiguación en libras para extender o comprimir el amortiguador a una velocidad de operación promedio. La puissance d'amortissement en poids de l'amortisseur, soit comprimé, doit détendu, à une vitesse de fonctionnement moyenne.

† At bumper contact / Al contacto con el tope de goma / Au contact avec le butoir

‡ For GasSLX Series, forces are at the "Firm" (F) setting. / Para la serie GasSLX, las fuerzas están ajustadas en (F) "Firme". / Pour la série GasSLX, le réglage de la force est sur «Ferme» (F).

## ESPECIFICACIONES POR TIPO DE MONTAJE

GRC	Montajes		Calibre de Pistón	Imagen de Diámetro Exterior	Longitudes [in]			Polvera	Tope Hidráulico	Fuerza*	
	Superior	Inferior			Extendido	Comprimido	Carrera			Rebote	Compresión
85959	ES150	ES150	1-5/8"	G	21.19	13.53	7.66	SÍ	SÍ	1021	123
85092	ES150	S21	1-5/8"	C	21.95	15.04	6.89	SÍ	SÍ	1597	138
49229	ES152	ES153			23.99	15.11	8.88				
G63640	ES152	ES153			23.89	15.11	8.78				
61598	ES152	ES153			23.79	15.01	8.78				
61589	ES152	ES153			21.29	13.51	7.78				
G63606	ES152	ES153			21.29	13.51	7.78				
83066	ES153	ES153	1-3/8"	A	11.15†	9.2†	2.78	SÍ	SÍ	599	221
85984	ES158	ES150	1-5/8"	G	25.44	15.96	9.48	SÍ	SÍ	2248	1168
85724	ES158	ES159	1-5/8"	D	22.78	14.5	8.28	SÍ	SÍ	1235	454
89443	ES158	ES159	1-5/8"	G	22.17	14.31	7.86	SÍ	SÍ	1206‡	466
85331	ES158	ES159	1-5/8"	D	19.66	12.88	6.78	SÍ	SÍ	1757	396
85335	ES158	ES159	1-5/8"	D	19.66	12.88	6.78	SÍ	SÍ	827	107
85947	ES160	ES160	1-5/8"	G	32.79	19.8	12.99	SÍ	SÍ	1387	396
85075	ES160	ES160	1-5/8"	C	26.37	16.43	9.84	SÍ	SÍ	1074	272
87019	ES160	ES160	2-1/16"	E	24.84	15.85	8.9	SÍ	SÍ	2972	665
87017	ES160	ES160	2-1/16"	E	23.35	15.31	8.07	SÍ	SÍ	1876	220
89461	ES160	ES160	1-5/8"	G	19.96	13.58	6.38	SÍ	SÍ	897‡	103
85381	ES161	BP35	1-5/8"	D	21.26	15.43	5.83	SÍ	SÍ	1719	815
85121	ES161	ES	1-5/8"	C	27.14	19.1	8.08	SÍ	SÍ	1429	199
85089	ES161	ES162	1-5/8"	C	25.78	16.56	9.22	SÍ	SÍ	1316	152
85088	ES161	ES162	1-5/8"	C	25.31	15.52	9.78	SÍ	SÍ	616	178
85061	ES161	ES162	1-5/8"	C	24.75	15.22	9.53	SÍ	SÍ	1216	195
85098	ES161	ES162	1-5/8"	C	24.64	15.25	9.39	SÍ	SÍ	747	158
85066	ES161	ES162	1-5/8"	C	24.63	15.22	9.41	SÍ	SÍ	812	322
89448	ES161	ES162	1-5/8"	G	24.62	15.54	9.08	SÍ	SÍ	782‡	323
89450	ES161	ES162	1-5/8"	G	24.62	15.54	9.08	SÍ	SÍ	1282‡	193
85094	ES161	ES182	1-5/8"	C	27.88	17.3	10.57	SÍ	NO	1345	334
83165	ES161	ES182	1-3/8"	A	27.78	17	10.78	SÍ	SÍ	900	305
85065	ES161	S21	1-5/8"	C	28.02	16.99	11.03	SÍ	SÍ	1059	300
69465	ES162	ES65			17.94	12.78	5.16				
85083	ES162	S42	1-5/8"	C	27.81	16.53	11.28	SÍ	SÍ	1429	184
83142	ES162	S42	1-3/8"	A	23.92	14.5	9.43	SÍ	SÍ	367	131
83143	ES162	S42	1-3/8"	A	21.92	13.5	8.43	SÍ	SÍ	403	137
83049	ES163	ES163	1-3/8"	A	8.02	6.53	1.48	SÍ	SÍ	2879	705
83025	ES163	ES163	1-3/8"	A	7.98	6.49	1.49	SÍ	SÍ	710	230
83032	ES163	ES163	1-3/8"	A	7.85	6.36	1.49	NO	SÍ	779	135
61777	ES164	ES68			15.62	10.68	4.94				
G63868	ES164	ES68			15.61	10.67	4.94				
83118	ES164	ES90	1-3/8"	A	24.45	14.71	9.74	SÍ	NO	410	311
83116	ES164	ES165	1-3/8"	A	23.81	14.68	9.12	SÍ	NO	354	300
83035	ES166	ES136	1-3/8"	A	12.96†	9.33	4.13	SÍ	SÍ	320	100
83029	ES168	ES169	1-5/8"	C	10.35	7.94	2.41	SÍ	NO	1303	1349

\* Damping force, in pounds, to either extend or collapse the shock absorber at an average operating velocity. Fuerza de amortiguación en libras para extender o comprimir el amortiguador a una velocidad de operación promedio. La puissance d'amortissement en poids de l'amortisseur, soit comprimé, doit détendu, à une vitesse de fonctionnement moyenne.

† At bumper contact / Al contacto con el tope de goma / Au contact avec le butoir

‡ For GasSLX Series, forces are at the "Firm" (F) setting. / Para la serie GasSLX, las fuerzas están ajustadas en (F) "Firme". / Pour la série GasSLX, le réglage de la force est sur «Firme» (F).

## ESPECIFICACIONES POR TIPO DE MONTAJE

GRC	Montajes		Calibre de Pistón	Imagen de Diámetro Exterior	Longitudes [in]			Polvera	Tope Hidráulico	Fuerza*	
	Superior	Inferior			Extendido	Comprimido	Carrera			Rebote	Compresión
83057	ES171	ES172	1-3/8"	2-1/2" D/T	10.44†	8.4†	2.99	SÍ	SÍ	364	242
83040	ES171	ES172	1-3/8"	A	10.41†	8.36†	2.99	SÍ	SÍ	876	326
87015	ES173	ES173	45MM	E	15.51	11.18	4.33	SÍ	SÍ	4950	900
85737	ES173	ES173	1-5/8"	D	15.11	10.84	4.27	SÍ	SÍ	3066	782
89459	ES174	EB3	1-5/8"	G	25.62	15.86	9.78	SÍ	NO	1179‡	314
85070	ES174	EB3	1-5/8"	C	25.6	15.82	9.78	SÍ	NO	1100	310
85067	ES174	ES136	1-5/8"	C	30.51	18.1	12.41	SÍ	SÍ	676	170
89451	ES174	ES136	1-5/8"	G	30.36	18.41	11.95	SÍ	SÍ	645‡	172
85989	ES174	ES136	1-5/8"	G	20.78	13.15	7.63	SÍ	NO	1812	351
85084	ES174	ES136	1-5/8"	C	20.59	13.03	7.57	SÍ	NO	1145	407
89460	ES174	ES136	1-5/8"	G	20.58	13.03	7.55	SÍ	NO	997	384
85985	ES174	S43	1-5/8"	G	19.04	12.31	6.73	SÍ	SÍ	2068	723
85937	ES174	S43	1-5/8"	G	18.98	12.26	6.72	SÍ	SÍ	1479	337
85936	ES174	S43	1-5/8"	G	17.23	11.38	5.85	SÍ	SÍ	1479	337
89456	ES174	S43	1-5/8"	G	17.02	11.29	5.73	SÍ	SÍ	975‡	377
83063	ES175	ES136	1-3/8"	A	10.76†	9.26†	3.01	SÍ	SÍ	954	541
85955	ES175	ES150	1-5/8"	G	21.25	13.66	7.59	SÍ	SÍ	1034	397
85986	ES175	ES150	1-5/8"	G	21.25	13.66	7.59	SÍ	SÍ	1754	221
85120	ES175	ES175	1-5/8"	C	23.67	15.06	8.61	SÍ	NO	2083	519
83163	ES175	ES175	1-3/8"	A	20.75	13.01	7.74	SÍ	NO	828	98
83175	ES175	ES175	1-3/8"	A	20.48	13.19	7.29	SÍ	NO	1245	156
85933	ES175	ES175	1-5/8"	G	18.23	12.71	5.52	SÍ	SÍ	1089	383
89454	ES175	ES175	1-5/8"	G	18.23	12.78	5.45	SÍ	SÍ	938‡	388
85081	ES175	S21	1-5/8"	C	23.44	14.33	9.11	SÍ	SÍ	1658	250
85080	ES175	S21	1-5/8"	C	22.51	13.78	8.74	SÍ	NO	447	138
85031	ES176	EB2	1-5/8"	C	25.63	15.85	9.78	SÍ	NO	941	257
85076	ES177	ES56	1-5/8"	C	27	16.35	10.65	SÍ	SÍ	1008	149
85923	ES177	ES161	1-5/8"	G	22.48	14.5	7.98	SÍ	SÍ	1940	221
85931	ES177	ES161	1-5/8"	G	22.48	14.5	7.98	SÍ	SÍ	1435	220
89458	ES177	ES161	1-5/8"	G	22.47	14.25	7.95	SÍ	SÍ	1575‡	222
85930	ES177	ES161	1-5/8"	G	17.86	12	5.86	SÍ	SÍ	1617	342
85932	ES178	ES150	1-5/8"	G	21.23	13.62	7.61	SÍ	SÍ	1102	430
89453	ES178	ES150	1-5/8"	G	21.1	13.78	7.32	SÍ	SÍ	860‡	435
85965	ES178	ES161	1-5/8"	G	24.24	15.15	9.09	SÍ	SÍ	2206	238
85966	ES178	ES161	1-5/8"	G	23.25	14.64	8.62	SÍ	SÍ	2206	238
85967	ES178	ES176	1-5/8"	G	23.93	14.86	9.07	SÍ	SÍ	2206	238
85961	ES178	ES176	1-5/8"	G	22.83	14.17	8.66	SÍ	SÍ	2206	240
85962	ES178	ES176	1-5/8"	G	21.8	13.66	8.15	SÍ	SÍ	2206	240
85980	ES179	ES179	1-5/8"	G	31.17	18.66	12.52	SÍ	SÍ	582	138
83148	ES179	ES179	1-3/8"	A	30	17.83	12.17	SÍ	SÍ	604	149
85978	ES179	ES179	1-5/8"	G	29.91	18.13	11.79	SÍ	SÍ	582	138
83147	ES179	ES179	1-3/8"	A	28.53	17.34	11.15	SÍ	SÍ	358	128
83166	ES179	ES179	1-3/8"	A	25.28	15.78	9.49	SÍ	SÍ	622	132

\* Damping force, in pounds, to either extend or collapse the shock absorber at an average operating velocity. Fuerza de amortiguación en libras para extender o comprimir el amortiguador a una velocidad de operación promedio. La puissance d'amortissement en poids de l'amortisseur, soit comprimé, doit détendu, à une vitesse de fonctionnement moyenne.

† At bumper contact / Al contacto con el tope de goma / Au contact avec le butoir

‡ For GasSLX Series, forces are at the "Firm" (F) setting. / Para la serie GasSLX, las fuerzas están ajustadas en (F) "Firme". / Pour la série GasSLX, le réglage de la force est sur «Firme» (F).

## ESPECIFICACIONES POR TIPO DE MONTAJE

GRC	Montajes		Calibre de Pistón	Imagen de Diámetro Exterior	Longitudes [in]			Polvera	Tope Hidráulico	Fuerza*	
	Superior	Inferior			Extendido	Comprimido	Carrera			Rebote	Compresión
83168	ES179	ES179	1-3/8"	A	25.28	15.78	9.49	SÍ	SÍ	246	88
85377	ES182	ES182	1-5/8"	D	23.8	14.84	8.96	SÍ	SÍ	1937	570
85378	ES182	ES182	1-5/8"	D	23.8	14.84	8.96	SÍ	SÍ	1110	240
85956	ES183	ES184	1-5/8"	G	30.63	18.75	11.87	SÍ	SÍ	979	373
83172	ES184	ES184	1-3/8"	C	26.56	17.08	9.48	SÍ	NO	1085	340
85993	ES184	S21	1-5/8"	G	22.19	13.99	8.2	SÍ	SÍ	2210	635
85973	ES184	S21	1-5/8"	G	21.84	13.99	7.85	SÍ	NO	1726	640
61656	ES185	ES185			31.51	18.48	13.03				
61654	ES185	ES185			28.76	16.98	11.78				
61629	ES185	ES185			26.98	15.95	11.03				
61657	ES185	ES185			25.48	15.2	10.28				
58461	ES185	ES185			25.37	15.24	10.13				
61547	ES185	ES185			23.01	14.07	8.94				
61655	ES185	ES185			23.01	14.07	8.94				
43167	ES185	ES185			22.99	13.88	9.11				
61627	ES185	ES185			22.98	13.95	9.03				
61554	ES185	ES185			21.48	13.2	8.28				
43142	ES185	ES185			21.45	13.12	8.33				
81924	ES185	ES185			20.78	12.67	8.11				
61659	ES185	ES185			20.76	12.98	7.78				
G63776	ES185	ES185			20.76	12.98	7.78				
49230	ES185	ES185			20.27	12.79	7.48				
69591	ES185	ES185			17.73	11.72	6.01				
83053	ES185	ES185	1-3/8"	A	10.91	7.93	2.97	SÍ	SÍ	968	214
83054	ES185	ES185	1-3/8"	A	10.28	7.56	2.72	SÍ	SÍ	1004	184
83052	ES185	ES185	1-3/8"	2-1/2" D/T	9.41	7.19	2.23	SÍ	NO	1101	149
83062	ES185	S42	1-3/8"	A	12.71	9.18	3.53	SÍ	NO	704	153
85739	ES187	ES187	1-5/8"	D	20.73	13.54	7.19	SÍ	SÍ	3247	334
85341	ES188	S21	1-5/8"	D	30.95	18.1	12.85	SÍ	SÍ	1807	333
85970	ES188	S21	1-5/8"	G	27.19	16.4	10.78	SÍ	SÍ	1092	147
85340	ES188	S21	1-5/8"	D	26.46	15.85	10.61	SÍ	SÍ	1807	165
85118	ES190	ES190	1-5/8"	C	24.69	15.52	9.17	SÍ	NO	575	195
85945	ES191	ES191	1-5/8"	G	26.38	16.66	9.72	SÍ	SÍ	1485	185
85946	ES191	ES191	1-5/8"	G	24.37	15.64	8.74	SÍ	SÍ	2074	160
85950	ES192	ES192	1-5/8"	G	27.33	16.98	10.35	SÍ	SÍ	1807	124
86203	ES193	ES193	45 MM	D	16.88	11.61	5.27	SÍ	SÍ	4238	910
86202	ES193	ES193	45 MM	D	14.52	10.43	4.09	SÍ	SÍ	4238	688
86201	ES193	ES193	45 MM	D	13.26	9.94	3.32	SÍ	SÍ	4238	688
86200	ES194	ES194	45 MM	D	14.24	10.45	3.79	SÍ	SÍ	4238	688
82138	S1	BP3			15.1	9.49	5.61				
82129	S1	BP3			12.51	8.5	4.01				
61529	S1	BP4			14.1	9.34	4.76				
G63900	S1	BP4			14.1	9.34	4.76				

\* Damping force, in pounds, to either extend or collapse the shock absorber at an average operating velocity. Fuerza de amortiguación en libras para extender o comprimir el amortiguador a una velocidad de operación promedio. La puissance d'amortissement en poids de l'amortisseur, soit comprimé, doit détendu, à une vitesse de fonctionnement moyenne.



## ESPECIFICACIONES POR TIPO DE MONTAJE

GRC	Montajes		Calibre de Pistón	Imagen de Diámetro Exterior	Longitudes [in]			Polvera	Tope Hidráulico	Fuerza*	
	Superior	Inferior			Extendido	Comprimido	Carrera			Rebote	Compresión
61540	S1	BP4			13.7	8.92	4.78				
G63457	S1	BP4			13.7	8.92	4.78				
81582	S1	BP4			13.45	8.84	4.61				
81548	S1	BP7			20.6	12.59	8.01				
81869	S1	BP7			20.6	12.59	8.01				
61535	S1	BP7			20.45	12.67	7.78				
61664	S1	BP7			20.45	12.67	7.78				
G63424	S1	BP7			20.45	12.67	7.78				
G63847	S1	BP7			20.45	12.67	7.78				
77424	S1	BP7			20.34	12.59	7.75				
77847	S1	BP7			20.34	12.59	7.75				
69675	S1	BP7			14.61	9.25	5.36				
81446	S1	BP7			14.61	9.25	5.36				
34073	S1	BP7			14.29	9.37	4.92				
61556	S1	BP7			14.2	9.09	5.11				
81714	S1	BP7			14.2	9.09	5.11				
G63950	S1	BP7			14.2	9.09	5.11				
77915	S1	BP7			13.61	8.85	4.76				
61512	S1	BP7			13.2	8.59	4.61				
81559	S1	BP7			13.2	8.59	4.61				
G63915	S1	BP7			13.2	8.59	4.61				
83003	S1	BP7	1-3/8"	A	11.76	8.95†	3.4	Sí	Sí	248	100
81670	S1	BP7			11.7	7.84	3.86				
82110	S1	BP8			14.1	8.99	5.11				
82075	S1	BP10			16.1	10.34	5.76				
77418	S1	BP11			14.14	9.04	5.10				
G63418	S1	BP11			13.95	9.17	4.78				
61650	S1	BP13			15.7	9.92	5.78				
81834	S1	BP13			15.7	9.84	5.86				
G63360	S1	BP13			15.7	9.92	5.78				
58360	S1	BP13			15.42	9.89	5.53				
58359	S1	BP13			13.92	9.14	4.78				
61523	S1	BP13			13.7	8.92	4.78				
81096	S1	BP13			13.7	8.84	4.86				
G63359	S1	BP13			13.7	8.92	4.78				
34052	S1	BP13			13.62	9	4.62				
77359	S1	BP13			13.55	8.84	4.71				
61509	S1	BP14			14.7	9.34	5.36				
81541	S1	BP14			14.7	9.34	5.36				
G63903	S1	BP14			14.7	9.34	5.36				
77903	S1	BP14			14.64	9.33	5.31				
69714	S1	BP17			14.1	9.94	4.16				
77937	S1	BP19			14.93	9.35	5.58				

\* Damping force, in pounds, to either extend or collapse the shock absorber at an average operating velocity. Fuerza de amortiguación en libras para extender o comprimir el amortiguador a una velocidad de operación promedio. La puissance d'amortissement en poids de l'amortisseur, soit comprimé, soit détendu, à une vitesse de fonctionnement moyenne.

† At bumper contact / Al contacto con el tope de goma / Au contact avec le butoir

## ESPECIFICACIONES POR TIPO DE MONTAJE

GRC	Montajes		Calibre de Pistón	Imagen de Diámetro Exterior	Longitudes [in]			Polvera	Tope Hidráulico	Fuerza*	
	Superior	Inferior			Extendido	Comprimido	Carrera			Rebote	Compresión
81908	S1	BP19			14.75	9.34	5.41				
61606	S1	BP19			14.7	9.34	5.36				
G63937	S1	BP19			14.7	9.34	5.36				
69625	S1	BP19			14.11	9	5.11				
82099	S1	BP19			14.11	9	5.11				
82087	S1	BP20			14.61	9.25	5.36				
61504	S1	BP30			13.7	8.92	4.78				
G63421	S1	BP30			13.7	8.92	4.78				
69600	S1	BP30			13.61	8.75	4.86				
81494	S1	BP30			13.61	8.75	4.86				
81750	S1	BP30			13.61	8.75	4.86				
77421	S1	BP30			13.55	8.84	4.71				
58421	S1	BP30			13.42	8.89	4.53				
34051	S1	BP30			13.28	8.67	4.61				
82070	S1	DS1			15.75	9.99	5.76				
6856SE	S1	EB1			27.3	15.77	11.53				
G63860	S1	EB1			24.33	14.39	9.94				
69813	S1	EB1			24.26	14.15	10.11				
61586	S1	EB1			22.95	13.67	9.28				
82066	S1	EB1			22.7	13.34	9.36				
61558	S1	EB1			22.45	13.42	9.03				
83509	S1	EB1	1-3/16"		21.45	12.76	8.69	SÍ	NO	567	250
6805SE	S1	EB1			21.2	12.59	8.61				
49205	S1	EB1			21.12	13.13	7.99				
69880	S1	EB1			21.1	12.84	8.26				
43140	S1	EB1			20.92	12.84	8.08				
83161	S1	EB1	1-3/8"	A	20.82	12.56	8.25	SÍ	NO	400	70
81340	S1	EB1			20.7	12.34	8.36				
82155	S1	EB1			20.7	12.34	8.36				
49114	S1	EB1			20.24	12.51	7.73				
49203	S1	EB1			20.24	12.51	7.73				
69606	S1	EB1			20.2	12.34	7.86				
81495	S1	EB1			20.2	12.34	7.86				
69676	S1	EB1			19.7	11.84	7.86				
81481	S1	EB1			19.7	11.84	7.86				
75676	S1	EB1			19.66	11.83	7.83				
82039	S1	EB1			17.7	10.84	6.86				
82603	S1	EB1			17.7	10.84	6.86				
G63798	S1	EB1			15.98	10.2	5.78				
61549	S1	EB1			15.89	10.11	5.78				
81675	S1	EB1			15.7	9.84	5.86				
69670	S1	EB1			14.1	9.34	4.76				
83513	S1	EB2	1-3/16"		23.74	13.98	9.76	SÍ	NO	353	186

\* Damping force, in pounds, to either extend or collapse the shock absorber at an average operating velocity. Fuerza de amortiguación en libras para extender o comprimir el amortiguador a una velocidad de operación promedio. La puissance d'amortissement en poids de l'amortisseur, soit comprimé, soit détendu, à une vitesse de fonctionnement moyenne.

## ESPECIFICACIONES POR TIPO DE MONTAJE

GRC	Montajes		Calibre de Pistón	Imagen de Diámetro Exterior	Longitudes [in]			Polvera	Tope Hidráulico	Fuerza*	
	Superior	Inferior			Extendido	Comprimido	Carrera			Rebote	Compresión
83514	S1	EB2	1-3/16"		23.74	13.98	9.76	SÍ	NO	430	145
83515	S1	EB2	1-3/16"		23.34	13.89	9.45	SÍ	NO	643	205
61507	S1	EB2			21.11	12.83	8.28				
69420	S1	EB3			22.81	14.68	8.13				
82067	S1	EB4			20.86	12.5	8.36				
82617	S1	EB4			18.86	11.5	7.36				
G63432	S1	EB19			21.11	12.83	8.28				
69677	S1	ES8			18.45	11.34	7.11				
82090	S1	ES8			16.11	10	6.11				
82072	S1	ES8			11.61	7.75	3.86				
82040	S1	ES10			21.7	12.84	8.86				
49122	S1	ES10			21.62	13.14	8.48				
82011	S1	ES11			12.11	8	4.11				
82601	S1	ES16			13.61	8.75	4.86				
77909	S1	ES17			14.14	9.04	5.10				
82074	S1	ES24			18.7	11.34	7.36				
81691	S1	ES25			24.2	14.09	10.11				
G63387	S1	ES25			23.32	14.04	9.28				
61647	S1	ES25			23.23	13.95	9.28				
81285	S1	ES25			23.2	13.84	9.36				
58387	S1	ES25			23.15	14.03	9.12				
49178	S1	ES25			23.12	13.89	9.23				
61551	S1	ES25			22.45	13.42	9.03				
G63511	S1	ES25			22.45	13.42	9.03				
49173	S1	ES25			19.24	12.01	7.23				
81242	S1	ES25			19.2	11.59	7.61				
43099	S1	ES25			19.17	11.77	7.40				
G63350	S1	ES25			18.82	11.79	7.03				
61518	S1	ES25			18.73	11.7	7.03				
58350	S1	ES25			18.6	11.65	6.95				
61679	S1	ES25			14.71	9.49	5.22				
G63881	S1	ES25			14.71	9.49	5.22				
77958	S1	ES25			14.51	9.35	5.16				
82109	S1	ES32			13.64	8.74	4.90				
81153	S1	ES38			11.61	7.75	3.86				
G63444	S1	ES64			23.3	14.02	9.28				
81501	S1	ES64			21.6	14.44	7.16				
69674	S1	ES64			21.2	12.84	8.36				
61546	S1	ES64			18.45	11.67	6.78				
82005	S1	ES64			17.2	12.44	4.76				
G63404	S1	ES64			17.05	11.02	6.03				
81553	S1	ES64			15.2	9.59	5.61				
61593	S1	ES64			14.95	9.67	5.28				

\* Damping force, in pounds, to either extend or collapse the shock absorber at an average operating velocity. Fuerza de amortiguación en libras para extender o comprimir el amortiguador a una velocidad de operación promedio. La puissance d'amortissement en poids de l'amortisseur, soit comprimé, soit détendu, à une vitesse de fonctionnement moyenne.

## ESPECIFICACIONES POR TIPO DE MONTAJE

GRC	Montajes		Calibre de Pistón	Imagen de Diámetro Exterior	Longitudes [in]			Polvera	Tope Hidráulico	Fuerza*	
	Superior	Inferior			Extendido	Comprimido	Carrera			Rebote	Compresión
81872	S1	ES64			14.95	9.59	5.36				
G63495	S1	ES64			14.95	9.67	5.28				
G63611	S1	ES64			14.95	9.67	5.28				
G63904	S1	ES64			14.95	9.95	5.00				
77904	S1	ES64			14.83	9.54	5.29				
61545	S1	ES64			14.45	9.67	4.78				
G63612	S1	ES64			14.45	9.67	4.78				
81507	S1	ES64			14.26	9.15	5.11				
61508	S1	ES64			14.11	9	5.11				
G63909	S1	ES64			14.11	9	5.11				
61501	S1	ES64			12.6	8.59	4.01				
81478	S1	ES64			12.6	8.59	4.01				
G63902	S1	ES64			12.6	8.59	4.01				
77902	S1	ES64			12.56	8.5	4.06				
G63862	S1	ES67			25.07	14.94	10.13				
69900	S1	ES67			24.91	14.8	10.11				
81322	S1	ES67			15.51	10	5.51				
69725	S1	ES69			21.6	13.09	8.51				
61596	S1	ES69			14.45	9.42	5.03				
G63635	S1	ES69			14.45	9.42	5.03				
81902	S1	ES76			14.75	9.39	5.36				
G63905	S1	ES76			14.7	9.34	5.36				
G64006	S1	ES81			22.75	13.81	8.94				
G64007	S1	ES81			22.75	13.81	8.94				
G63889	S1	ES81			20.44	12.75	7.69				
G64005	S1	ES81			19.75	12.31	7.44				
G64004	S1	ES81			19.07	12.13	6.94				
83507	S1	ES83	1-3/16"	F	24.14	14.16	9.99	SÍ	NO	395	87
75755	S1	ES83			20.34	12.59	7.75				
81836	S1	ES83			14.75	9.39	5.36				
61601	S1	ES83			14.71	9.49	5.22				
77905	S1	ES83			14.64	9.33	5.31				
69757	S1	ES85			24.6	17.54	7.06				
81671	S1	ES85			23.35	15.44	7.91				
69633	S1	ES91			20.7	12.34	8.36				
81460	S1	ES91			20.7	12.34	8.36				
49199	S1	ES91			20.68	12.7	7.98				
43143	S1	ES91			20.42	12.34	8.08				
69592	S1	ES107			20.07	12.56	7.51				
69593	S1	ES107			20.07	12.56	7.51				
81558	S1	ES109			19.01	12.35	6.66				
77781	S1	ES113			18.57	11.8	6.77				
G63781	S1	ES113			18.45	11.93	6.52				

\* Damping force, in pounds, to either extend or collapse the shock absorber at an average operating velocity. Fuerza de amortiguación en libras para extender o comprimir el amortiguador a una velocidad de operación promedio. La puissance d'amortissement en poids de l'amortisseur, soit comprimé, soit détendu, à une vitesse de fonctionnement moyenne.

## ESPECIFICACIONES POR TIPO DE MONTAJE

GRC	Montajes		Calibre de Pistón	Imagen de Diámetro Exterior	Longitudes [in]			Polvera	Tope Hidráulico	Fuerza*	
	Superior	Inferior			Extendido	Comprimido	Carrera			Rebote	Compresión
77479	S1	ES113			14.14	9.04	5.10				
61552	S1	ES113			13.95	9.17	4.78				
G63479	S1	ES113			13.95	9.17	4.78				
81870	S1	ES113			13.86	9	4.86				
G63547	S1	ES113			13.61	9.08	4.53				
77782	S1	ES118			14.14	9.04	5.10				
G63782	S1	ES118			13.7	9.09	4.61				
69671	S1	ES133			18.1	11.34	6.76				
81795	S1	ES143			19.2	13.94	5.26				
61610	S1	ES153			19.04	11.76	7.28				
81911	S1	ES153			19.04	11.68	7.36				
G63710	S1	ES153			18.96	11.93	7.03				
49196	S1	ES185			23.74	14.26	9.48				
69709	S1	ES185			23.7	13.84	9.86				
81461	S1	ES185			23.7	13.84	9.86				
69755	S1	ES185			20.45	12.34	8.11				
81674	S1	ES185			20.45	12.34	8.11				
69898	S1	ES185			19.85	14.19	5.66				
81794	S1	ES185			19.85	14.19	5.66				
49234	S1	ES185			19.77	13.98	5.79				
49613	S1	ES185			19.12	11.97	7.15				
G63799	S1	ES185			18.55	11.77	6.78				
81904	S1	ES185			18.46	11.7	6.76				
61560	S1	ES185			18.45	11.67	6.78				
82038	S1	S1			24.67	14.06	10.61				
G63187	S1	S1			22.92	13.39	9.53				
6803SE	S1	S1			22.52	13.36	9.16				
82034	S1	S1			22.17	12.81	9.36				
83400	S1	S1	1-3/16"	F	22.02	12.82	9.2	Sí	NO	301	120
14016	S1	S1			21.4	12.33	9.07				
6851SE	S1	S1			21.27	12.49	8.78				
6857SE	S1	S1			21.27	12.49	8.78				
6858SE	S1	S1			21.27	12.49	8.78				
6826SE	S1	S1			21.17	12.31	8.86				
G63398	S1	S1			20.42	12.14	8.28				
6852SE	S1	S1			20.27	11.99	8.28				
6859SE	S1	S1			20.27	11.99	8.28				
6860SE	S1	S1			20.27	11.99	8.28				
6861SE	S1	S1			20.27	11.99	8.28				
6862SE	S1	S1			20.27	11.99	8.28				
6863SE	S1	S1			20.27	11.99	8.28				
6849SE	S1	S1			20.17	11.81	8.36				
6802SE	S1	S1			20.02	12.11	7.91				

\* Damping force, in pounds, to either extend or collapse the shock absorber at an average operating velocity. Fuerza de amortiguación en libras para extender o comprimir el amortiguador a una velocidad de operación promedio. La puissance d'amortissement en poids de l'amortisseur, soit comprimé, soit détendu, à une vitesse de fonctionnement moyenne.

## ESPECIFICACIONES POR TIPO DE MONTAJE

GRC	Montajes		Calibre de Pistón	Imagen de Diámetro Exterior	Longitudes [in]			Polvera	Tope Hidráulico	Fuerza*	
	Superior	Inferior			Extendido	Comprimido	Carrera			Rebote	Compresión
49105	S1	S1			18.21	11.23	6.98				
81270	S1	S1			17.67	10.56	7.11				
82069	S1	S1			14.59	9.31	5.28				
82026	S1	S1			13.42	8.56	4.86				
82049	S1	S1			13.17	8.31	4.86				
83014	S1	S1	1-3/8"	A	10.48	7.11	3.37	NO	NO	544	501
69704	S1	S12			10.67	7.06	3.61				
81406	S1	S12			10.67	7.06	3.61				
G51742	S2				22.12	17.37	4.75				
G51772	S4				26	17.37	8.63				
82118	S5	BP19			15.31	10.06	5.25				
81542	S8	EB1			20.1	12.34	7.76				
G63484	S8	EB1			20.05	12.52	7.53				
61513	S8	EB1			19.95	12.42	7.53				
82020	S8	ES62			18.11	11	7.11				
61502	S8	S1			20.67	12.06	8.61				
82125	S8	S1			20.67	12.06	8.61				
81416	S9	EB1			18.6	11.59	7.01				
82123	S9	EB1			18.6	11.59	7.01				
61685	S11	BP9			14.12	9.68	4.44				
G63895	S11	BP9			14.12	9.68	4.44				
61684	S11	BP9			12.82	8.88	3.94				
G63894	S11	BP9			12.82	8.88	3.94				
61683	S11	Horquilla			15.07	10.44	4.63				
G63893	S11	Horquilla			15.07	10.44	4.63				
G64001	S11	Horquilla			14.67	11.47	3.20				
49216	S12	BP7			20.74	12.76	7.98				
69756	S12	BP7			20.45	12.34	8.11				
81693	S12	BP7			20.45	12.34	8.11				
G63621	S12	BP7			16.46	10.93	5.53				
61569	S12	BP7			16.33	10.8	5.53				
81826	S12	BP7			15.6	10.09	5.51				
61555	S12	BP7			14.14	9.11	5.03				
77375	S12	BP7			14.14	9.04	5.10				
G63375	S12	BP7			14.14	9.11	5.03				
61615	S12	BP11			20.3	12.27	8.03				
81936	S12	BP11			20.3	12.19	8.11				
G63721	S12	BP11			20.21	12.43	7.78				
81920	S12	BP11			14.71	10.1	4.61				
61641	S12	BP11			14.7	10.17	4.53				
77783	S12	BP11			14.64	10.12	4.52				
58783	S12	BP11			14.59	10.21	4.38				
G63783	S12	BP11			14.59	10.21	4.38				

\* Damping force, in pounds, to either extend or collapse the shock absorber at an average operating velocity. Fuerza de amortiguación en libras para extender o comprimir el amortiguador a una velocidad de operación promedio. La puissance d'amortissement en poids de l'amortisseur, soit comprimé, soit détendu, à une vitesse de fonctionnement moyenne.

## ESPECIFICACIONES POR TIPO DE MONTAJE

GRC	Montajes		Calibre de Pistón	Imagen de Diámetro Exterior	Longitudes [in]			Polvera	Tope Hidráulico	Fuerza*	
	Superior	Inferior			Extendido	Comprimido	Carrera			Rebote	Compresión
81491	S12	DS1			13	8.74	4.26				
G63446	S12	EB1			23.3	14.02	9.28				
58410	S12	EB1			18.62	11.75	6.87				
G63410	S12	EB1			18.55	11.77	6.78				
77410	S12	EB1			18.47	11.71	6.76				
49388	S12	EB2			21.79	13.39	8.40				
49387	S12	EB2			21.14	13.03	8.11				
61588	S12	EB2			21.11	13.08	8.03				
81906	S12	EB19			21.11	13.1	8.01				
G63548	S12	EB19			21.11	13.08	8.03				
G63726	S12	EB19			21.05	12.77	8.28				
77726	S12	EB19			20.85	13.05	7.80				
34058	S12	ES3			17.13	11.01	6.12				
82614	S12	ES5			12.01	8.25	3.76				
81925	S12	ES7			14.7	9.59	5.11				
69891	S12	ES10			21.61	13.1	8.51				
G63447	S12	ES25			30.18	17.65	12.53				
58416	S12	ES25			18.42	11.8	6.62				
G63396	S12	ES25			16.55	10.77	5.78				
61521	S12	ES25			16.45	10.67	5.78				
77661	S12	ES34			13.72	9.5	4.22				
82608	S12	ES39			20.85	13.94	6.91				
34057	S12	ES41			15.01	10.14	4.87				
81490	S12	ES41			14.85	9.84	5.01				
G63817	S12	ES60			15.8	11.02	4.78				
77817	S12	ES60			15.73	10.94	4.79				
61663	S12	ES60			15.7	10.92	4.78				
58817	S12	ES60			15.59	10.96	4.63				
81508	S12	ES64			21.6	13.34	8.26				
61607	S12	ES64			15.89	10.11	5.78				
G63707	S12	ES64			15.89	10.11	5.78				
75898	S12	ES83			19.85	14.18	5.67				
75795	S12	ES110			15.24	9.66	5.58				
69795	S12	ES110			15.2	9.59	5.61				
81791	S12	ES110			15.2	9.59	5.61				
77778	S12	ES169			24.38	14.36	10.02				
G63715	S12	ES171			28.55	16.52	12.03				
61612	S12	ES171			28.39	16.36	12.03				
81913	S12	ES171			28.39	16.28	12.11				
58715	S12	ES171			28.34	16.46	11.88				
77715	S12	ES171			28.32	16.33	11.99				
G63778	S12	ES171			24.55	14.52	10.03				
61638	S12	ES171			24.45	14.42	10.03				

\* Damping force, in pounds, to either extend or collapse the shock absorber at an average operating velocity. Fuerza de amortiguación en libras para extender o comprimir el amortiguador a una velocidad de operación promedio. La puissance d'amortissement en poids de l'amortisseur, soit comprimé, soit détendu, à une vitesse de fonctionnement moyenne.

## ESPECIFICACIONES POR TIPO DE MONTAJE

GRC	Montajes		Calibre de Pistón	Imagen de Diámetro Exterior	Longitudes [in]			Polvera	Tope Hidráulico	Fuerza*	
	Superior	Inferior			Extendido	Comprimido	Carrera			Rebote	Compresión
58778	S12	ES171			24.34	14.46	9.88				
81892	S12	ES171			24.2	14.09	10.11				
49237	S12	ES171			24.18	14.45	9.73				
G63416	S12	ES185			18.55	11.77	6.78				
61643	S12	Horquilla			15.36	10.33	5.03				
G63803	S12	Horquilla			15.36	10.33	5.03				
81922	S12	Horquilla			15.35	10.24	5.11				
58803	S12	Horquilla			15.24	10.37	4.87				
49228	S15	BP14			24.47	14.74	9.73				
83317	S16	ES90	1-3/8"	B	27.03	16	11.34	SÍ	SÍ		
83301	S16	ES90	1-3/8"	B	24.52	14.74	9.78	SÍ	SÍ	653	86
83318	S16	S16	1-3/8"	B	22.53	13.5	9.03	SÍ	SÍ	323	77
83613	S16	S16	1-3/8"	A	21.04	12.76	8.28	SÍ	SÍ	601	242
81440	S17	EB1			24.6	14.59	10.01				
69713	S17	EB1			23.85	14.59	9.26				
81498	S17	EB1			22.1	13.34	8.76				
82124	S17	EB1			22.1	13.34	8.76				
82002	S17	ES14			16.2	10.09	6.11				
82004	S17	S1			14.17	8.81	5.36				
G64056	S18	ES83			20.51	13.11	7.4				
69945	S19	ES84			26.35	16.45	9.90				
81934	S20	ES84			26.14	16.45	9.69				
69586	S20	ES89			23.5	15.62	7.88				
85731	S21	EB3	1-5/8"	D	30.57	18.54	12.03	SÍ	SÍ	1517	293
85703	S21	EB3	1-5/8"	D	29.57	18.54	11.03	SÍ	SÍ	1435	186
85033	S21	EB3	1-5/8"	C	27.21	17.37	9.84	SÍ	SÍ	764	254
89427	S21	EB3	1-5/8"	G	27.2	17.5	9.7	SÍ	SÍ	794‡	253
85317	S21	EB3	1-5/8"	D	27.18	17.42	9.76	SÍ	SÍ	764	254
85711	S21	EB3	1-5/8"	D	24.57	15.29	9.28	SÍ	SÍ	1435	208
87000	S21	EB3	2-1/16"	E	24.46	15.21	9.25	SÍ	SÍ	1332	300
85311	S21	EB3	1-5/8"	D	23.95	14.79	9.16	SÍ	SÍ	764	254
85988	S21	EB3	1-5/8"	G	23.84	14.87	8.97	SÍ	SÍ	1200	138
89424	S21	EB3	1-5/8"	G	23.7	15	8.7	SÍ	SÍ	794‡	253
85710	S21	EB3	1-5/8"	D	23.45	15.1	8.34	SÍ	SÍ	994	248
85343	S21	EB3	1-5/8"	D	22.96	14.79	8.17	SÍ	SÍ	858	289
87016	S21	EB3	2-1/16"	E	21.17	13.91	7.26	SÍ	SÍ	1808	238
G63828	S21	EB20			23.16	15.13	8.03				
85009	S21	ES36	1-5/8"	C	23.52	14.36	9.16	SÍ	SÍ	857	144
83134	S21	ES36	1-3/8"	A	22.24	13.5	8.74	SÍ	NO	430	49
85921	S21	ES36	1-5/8"	G	22.03	13.5	8.53	SÍ	NO	2053	339
85316	S21	ES36	1-5/8"	D	20.61	12.85	7.76	SÍ	NO	943	443
89426	S21	ES36	1-5/8"	G	20.43	12.93	7.5	SÍ	NO	926‡	419
85056	S21	ES36	1-5/8"	C	20.15	12.87	7.28	SÍ	SÍ	732	114

\* Damping force, in pounds, to either extend or collapse the shock absorber at an average operating velocity. Fuerza de amortiguación en libras para extender o comprimir el amortiguador a una velocidad de operación promedio. La puissance d'amortissement en poids de l'amortisseur, soit comprimé, soit détendu, à une vitesse de fonctionnement moyenne.

‡ For GasSLX Series, forces are at the "Firm" (F) setting. / Para la serie GasSLX, las fuerzas están ajustadas en (F) "Firme". / Pour la série GasSLX, le réglage de la force est sur «Ferme» (F).



## ESPECIFICACIONES POR TIPO DE MONTAJE

GRC	Montajes		Calibre de Pistón	Imagen de Diámetro Exterior	Longitudes [in]			Polvera	Tope Hidráulico	Fuerza*	
	Superior	Inferior			Extendido	Comprimido	Carrera			Rebote	Compresión
89441	S21	ES36	1-5/8"	G	20.14	13.06	7.08	SÍ	SÍ	761‡	126
85935	S21	ES36	1-5/8"	G	18.7	11.92	6.78	SÍ	NO	1054	419
85073	S21	ES56	1-5/8"	C	26.12	15.67	10.45	SÍ	SÍ	1250	152
85319	S21	ES150	1-5/8"	D	22.2	13.92	8.28	SÍ	SÍ	988	454
89428	S21	ES150	1-5/8"	G	21.96	14.13	7.83	SÍ	SÍ	958‡	446
G63832	S21	ES153			17.16	11.38	5.78				
87020	S21	ES182	2-1/16"	E	25.35	16.17	9.18	SÍ	SÍ	2479	967
85709	S21	S21	1-5/8"	D	31.64	18.36	13.28	SÍ	SÍ	700	203
85727	S21	S21	1-5/8"	D	29.89	17.36	12.53	SÍ	SÍ	783	111
83106	S21	S21	1-3/8"	A	29.25	16.76	12.49	SÍ	NO	451	80
83136	S21	S21	1-3/8"	A	29.25	16.76	12.49	SÍ	NO	914	65
85048	S21	S21	1-5/8"	C	29.16	16.88	12.28	SÍ	NO	432	106
85318	S21	S21	1-5/8"	D	27.37	16.36	11.01	SÍ	SÍ	1372	192
85722	S21	S21	1-5/8"	D	27.15	16.43	10.72	SÍ	SÍ	1264	369
85069	S21	S21	1-5/8"	C	26.28	15.94	10.34	SÍ	SÍ	762	255
89455	S21	S21	1-5/8"	G	26.28	15.92	10.36	SÍ	SÍ	791‡	276
85328	S21	S21	1-5/8"	D	25.64	15.36	10.28	SÍ	NO	930	383
85071	S21	S21	1-5/8"	C	25.57	15.04	10.53	SÍ	NO	610	107
85049	S21	S21	1-5/8"	C	25.53	15	10.53	SÍ	NO	597	107
85085	S21	S21	1-5/8"	C	24.95	14.67	10.23	SÍ	NO	970	101
85728	S21	S21	1-5/8"	D	24.39	14.86	9.53	SÍ	SÍ	1435	510
85117	S21	S21	1-5/8"	C	24.12	14.72	9.46	SÍ	SÍ	1149	152
83456	S21	S21	1-3/8"	B	24.03	14.25	9.78	SÍ	NO	566	80
85705	S21	S21	1-5/8"	D	23.65	14.24	9.41	SÍ	SÍ	639	436
85706	S21	S21	1-5/8"	D	23.65	14.24	9.41	SÍ	SÍ	1086	696
85707	S21	S21	2-1/16"	D	23.65	14.4	9.25	SÍ	SÍ	1761	986
87011	S21	S21	2-1/16"	E	23.65	14.4	9.25	SÍ	SÍ	1750	1050
87012	S21	S21	2-1/16"	E	23.65	14.4	9.25	SÍ	SÍ	650	364
87013	S21	S21	2-1/16"	E	23.65	14.4	9.25	SÍ	SÍ	1075	585
89447	S21	S21	1-5/8"	G	23.65	14.57	9.08	SÍ	SÍ	702‡	241
85325	S21	S21	1-5/8"	D	23.64	14.36	9.28	SÍ	NO	1024	240
85347	S21	S21	1-5/8"	D	23.62	14.22	9.4	SÍ	SÍ	961	122
85342	S21	S21	1-5/8"	D	23.28	13.99	9.29	SÍ	NO	893	188
83102	S21	S21	1-3/8"	A	22.94	13.56	9.38	SÍ	SÍ	513	333
85093	S21	S21	1-5/8"	C	22.46	13.85	8.61	SÍ	NO	1103	114
85324	S21	S21	1-5/8"	D	22.14	13.61	8.53	SÍ	NO	579	114
85346	S21	S21	1-5/8"	D	22.12	13.48	8.64	SÍ	SÍ	2016	285
85027	S21	S21	1-5/8"	C	21.52	12.99	8.53	SÍ	NO	1008	539
89418	S21	S21	1-5/8"	G	21.44	13.19	8.25	SÍ	NO	1266‡	515
695406	S21	S21	2-1/16"	E	21.39	13.26	8.13	SÍ	SÍ	1854	274
85982	S21	S21	1-5/8"	G	20.67	13.1	7.57	SÍ	SÍ	2241	440
85708	S21	S21	1-5/8"	D	20.64	12.86	7.78	SÍ	SÍ	914	204
85745	S21	S21	1-5/8"	D	19.88	12.34	7.54	SÍ	SÍ	3064	231

\* Damping force, in pounds, to either extend or collapse the shock absorber at an average operating velocity. Fuerza de amortiguación en libras para extender o comprimir el amortiguador a una velocidad de operación promedio. La puissance d'amortissement en poids de l'amortisseur, soit comprimé, soit détendu, à une vitesse de fonctionnement moyenne.

‡ For GasSLX Series, forces are at the "Firm" (F) setting. / Para la serie GasSLX, las fuerzas están ajustadas en (F) "Firme". / Pour la série GasSLX, le réglage de la force est sur «Ferme» (F).

## ESPECIFICACIONES POR TIPO DE MONTAJE

GRC	Montajes		Calibre de Pistón	Imagen de Diámetro Exterior	Longitudes [in]			Polvera	Tope Hidráulico	Fuerza*	
	Superior	Inferior			Extendido	Comprimido	Carrera			Rebote	Compresión
85746	S21	S21	1-5/8"	D	19.88	12.34	7.54	SÍ	SÍ	1754	167
83103	S21	S21	1-3/8"	A	19.64	11.89	7.75	SÍ	SÍ	517	301
85326	S21	S21	1-5/8"	D	19.64	12.36	7.28	SÍ	NO	799	142
85110	S21	S21	1-5/8"	C	19.18	12.12	7.06	SÍ	SÍ	2135	163
85902	S21	S21	1-5/8"	G	19.01	12.03	6.98	SÍ	SÍ	1441	267
85996	S21	S21	1-5/8"	G	19.01	12.03	6.98	SÍ	SÍ	3039	752
85336	S21	S21	1-5/8"	D	18.76	11.86	6.9	SÍ	NO	861	200
85310	S21	S21	1-5/8"	D	18.65	11.74	6.91	SÍ	SÍ	1379	578
89423	S21	S21	1-5/8"	G	18.65	12.07	6.58	SÍ	SÍ	1352‡	573
85900	S21	S21	1-5/8"	G	17.27	11.16	6.11	SÍ	SÍ	1467	337
85997	S21	S21	1-5/8"	G	17.27	11.16	6.11	SÍ	SÍ	3039	752
87007	S21	S21	2-1/16"	E	15.65	14.4	5.25	SÍ	SÍ	879	253
85701	S21	S21	1-5/8"	D	15.64	10.36	5.28	SÍ	SÍ	914	204
69946	S25	ES6			24.04	14.33	9.71				
69877	S26	ES3			20.94	14.76	6.18				
69863	S27	ES18			24.43	14.91	9.52				
69903	S27	ES18			21.69	12.99	8.70				
69807	S28	ES3			19.84	15.43	4.41				
81713	S29	BP7			14.42	9.31	5.11				
58489	S29	BP11			14.64	9.61	5.03				
61544	S29	BP11			14.54	9.75	4.79				
G63489	S29	BP11			14.42	9.64	4.78				
77489	S29	BP11			14.36	9.55	4.81				
81668	S29	BP11			14.32	9.56	4.76				
81933	S29	BP13			13.97	9.11	4.86				
77954	S29	BP13			13.83	9.08	4.75				
G63958	S29	BP13			13.8	9.13	4.67				
82013	S29	BP20			20.82	13.06	7.76				
49614	S29	ES24			19.04	11.94	7.10				
69407	S29	ES24			18.92	11.56	7.36				
81790	S29	ES24			18.92	11.56	7.36				
49371	S29	ES53			22.55	13.7	8.85				
69749	S29	ES53			21.92	13.06	8.86				
81530	S29	ES53			21.92	13.06	8.86				
49370	S29	ES84			21.6	15.04	6.56				
61503	S29	ES84			21.12	16.31	4.81				
69723	S29	ES84			21.12	16.31	4.81				
81517	S29	ES84			21.12	16.31	4.81				
G63914	S29	ES84			21.12	16.31	4.81				
77803	S29	Horquilla			15.31	10.32	4.99				
69878	S30	ES3			20.94	14.76	6.18				
69951	S30	ES3			19.6	14.72	4.88				
69950	S30	ES3			18.62	17.62	1.00				

\* Damping force, in pounds, to either extend or collapse the shock absorber at an average operating velocity. Fuerza de amortiguación en libras para extender o comprimir el amortiguador a una velocidad de operación promedio. La puissance d'amortissement en poids de l'amortisseur, soit comprimé, doit détendu, à une vitesse de fonctionnement moyenne.

‡ For GasSLX Series, forces are at the "Firm" (F) setting. / Para la serie GasSLX, las fuerzas están ajustadas en (F) "Firme". / Pour la série GasSLX, le réglage de la force est sur «Ferme» (F).

## ESPECIFICACIONES POR TIPO DE MONTAJE

GRC	Montajes		Calibre de Pistón	Imagen de Diámetro Exterior	Longitudes [in]			Polvera	Tope Hidráulico	Fuerza*	
	Superior	Inferior			Extendido	Comprimido	Carrera			Rebote	Compresión
69956	S30	ES3			18.62	17.55	1.07				
69957	S30	ES3			18.22	16.18	2.04				
G63506	S32	S32			21.4	12.64	8.76				
69952	S33	ES3			21.45	18.38	3.07				
69966	S33	ES3			17.62	11.27	6.35				
69773	S33	ES69			22.44	17.38	5.06				
70003	S34	ES147			26.55	18.62	7.93				
81893	S36	BP7			18.27	13.51	4.76				
G63678	S36	BP7			18.09	13.56	4.53				
61623	S36	BP7			18.04	13.51	4.53				
77678	S36	BP7			18.01	13.51	4.50				
77772	S36	BP10			14.51	9.72	4.79				
61626	S36	BP10			13.73	9.45	4.28				
G63772	S36	BP10			13.73	9.45	4.28				
81916	S36	BP10			13.72	9.46	4.26				
69794	S36	BP14			14.6	10.69	3.91				
69811	S36	BP14			13.6	9.69	3.91				
81792	S36	BP14			13.6	9.69	3.91				
75811	S36	BP14			13.55	9.67	3.88				
82025	S36	BP17			12.95	9.19	3.76				
82126	S36	DS1			14.25	9.24	5.01				
77807	S36	EB1			15.33	10.34	4.99				
G63622	S36	EB1			15.32	10.29	5.03				
58807	S36	EB1			15.24	10.11	5.13				
61561	S36	EB1			15.09	10.06	5.03				
G63614	S36	EB1			15.09	10.06	5.03				
58622	S36	EB1			15.04	10.16	4.88				
77614	S36	EB1			15.04	10.05	4.99				
G63929	S36	EB1			14.72	9.71	5.01				
34076	S36	EB1			14.59	9.87	4.72				
G63608	S36	EB1			14.56	9.78	4.78				
58929	S36	EB1			14.54	9.76	4.78				
81744	S36	EB1			14.52	9.76	4.76				
61591	S36	EB1			14.47	9.71	4.76				
77608	S36	EB1			14.45	9.64	4.81				
69766	S36	EB21			17.48	10.95	6.53				
77955	S36	ES7			22.57	13.91	8.66				
69574	S36	ES7			20.26	12.5	7.76				
G63720	S36	ES22			21.39	12.86	8.53				
81394	S36	ES25			17.47	11.21	6.26				
G63386	S36	ES25			16.11	10.58	5.53				
58386	S36	ES25			16.04	10.66	5.38				
61553	S36	ES25			15.09	10.06	5.03				

\* Damping force, in pounds, to either extend or collapse the shock absorber at an average operating velocity. Fuerza de amortiguación en libras para extender o comprimir el amortiguador a una velocidad de operación promedio. La puissance d'amortissement en poids de l'amortisseur, soit comprimé, soit détendu, à une vitesse de fonctionnement moyenne.

## ESPECIFICACIONES POR TIPO DE MONTAJE

GRC	Montajes		Calibre de Pistón	Imagen de Diámetro Exterior	Longitudes [in]			Polvera	Tope Hidráulico	Fuerza*	
	Superior	Inferior			Extendido	Comprimido	Carrera			Rebote	Compresión
G63500	S36	ES25			15.09	10.06	5.03				
81694	S36	ES25			14.72	9.71	5.01				
61711	S36	ES26			21.8	13.61	8.19				
82128	S36	ES40			11.2	8.19	3.01				
61520	S36	ES41			15.34	10.31	5.03				
G63414	S36	ES41			15.09	10.06	5.03				
58414	S36	ES41			15.04	10.16	4.88				
81742	S36	ES53			22.6	13.59	9.01				
81562	S36	ES74			19.85	15.54	4.31				
77414	S36	ES83			15.33	10.34	4.99				
69661	S36	ES137			20.1	15.04	5.06				
69845	S36	ES143			19.2	13.94	5.26				
69820	S36	ES143			19.1	11.84	7.26				
81881	S36	ES143			19.1	11.84	7.26				
69575	S36	ES162			20.16	12.4	7.76				
69996	S36	ES169			19.1	15.04	4.06				
G63445	S36	ES185			23.09	14.06	9.03				
81828	S36	ES185			22.72	14.21	8.51				
61646	S36	ES185			22.57	14.29	8.28				
G63623	S36	ES185			22.57	14.29	8.28				
58623	S36	ES185			22.54	13.91	8.63				
81833	S36	ES185			20.21	12.45	7.76				
G63624	S36	ES185			20.17	12.64	7.53				
61595	S36	ES185			20.07	12.54	7.53				
58624	S36	ES185			20.04	12.66	7.38				
G63603	S36	ES185			16.12	10.59	5.53				
58500	S36	ES185			15.04	10.16	4.88				
69962	S36	Horquilla			21.11	15.1	6.01				
81927	S36				21.01	15.87	5.14				
77714	S38	BP7			15.34	9.84	5.50				
77949	S38	BP27			16.16	10.67	5.49				
83512	S38	EB2	1-3/16"		21.65	12.99	8.66	Sí	NO	768	167
G63616	S38	EB19			23.78	14.25	9.53				
G63694	S38	EB20			22.18	13.4	8.78				
77716	S38	ES26			15.32	9.84	5.48				
77948	S38	ES34			23.5	14.75	8.75				
G63674	S38	ES34			23.39	14.36	9.03				
61712	S38	ES34			23.3	14.26	9.04				
G64009	S38	ES34			23.29	14.25	9.04				
61635	S38	ES34			23.27	14.24	9.03				
77674	S38	ES34			23.27	14.27	9.00				
58674	S38	ES34			23.22	14.09	9.13				
58673	S38	ES34			22.72	13.84	8.88				

\* Damping force, in pounds, to either extend or collapse the shock absorber at an average operating velocity. Fuerza de amortiguación en libras para extender o comprimir el amortiguador a una velocidad de operación promedio. La puissance d'amortissement en poids de l'amortisseur, soit comprimé, soit détendu, à une vitesse de fonctionnement moyenne.

## ESPECIFICACIONES POR TIPO DE MONTAJE

GRC	Montajes		Calibre de Pistón	Imagen de Diámetro Exterior	Longitudes [in]			Polvera	Tope Hidráulico	Fuerza*	
	Superior	Inferior			Extendido	Comprimido	Carrera			Rebote	Compresión
77673	S38	ES34			22.38	13.84	8.54				
61634	S38	ES34			22.3	13.77	8.53				
81919	S38	ES34			22.3	13.54	8.76				
G63673	S38	ES34			22.3	13.77	8.53				
61680	S38	ES34			20.83	13.39	7.44				
G63886	S38	ES34			20.8	13.36	7.44				
77951	S38	ES34			20.5	13	7.50				
81932	S38	ES34			15.87	10.51	5.36				
G63848	S38	ES34			15.87	10.59	5.28				
77947	S38	ES34			15.63	10.88	4.75				
58661	S38	ES34			14.22	9.59	4.63				
61599	S38	ES34			13.8	9.52	4.28				
G63661	S38	ES34			13.8	9.52	4.28				
81928	S38	ES34			13.78	9.52	4.26				
G64030	S38	ES36			22.56	13.86	8.70				
G64029	S38	ES36			21.73	13.54	8.19				
77623	S38	ES83			22.38	13.84	8.54				
83178	S38	ES83	1-3/8"	A	21.95	13.26	8.69	SÍ	NO	690	275
G63615	S38	S38			23.66	13.88	9.78				
69861	S39	ES28			15.51	10.23	5.28				
83177	S40	EB1	1-3/8"	A	14.99†	10.12	5.38	SÍ	NO	690	275
83114	S40	ES35	1-3/8"	A	23	13.76	9.24	SÍ	NO	450	102
83105	S40	ES179	1-3/8"	A	31.91	18.29	13.62	SÍ	NO	559	150
83162	S40	ES190	1-3/8"	A	24.35	14.69	9.67	SÍ	NO	877	52
85332	S42	ES36	1-5/8"	D	20.64	12.98	7.66	SÍ	SÍ	2351	967
85333	S42	ES36	1-5/8"	D	20.64	12.98	7.66	SÍ	SÍ	1241	534
85981	S43	ES184	1-5/8"	G	27.15	16.78	10.37	SÍ	NO	1574	535
83173	S43	S43	1-3/8"	A	23.17	14.02	9.15	SÍ	NO	1020	105
70013	S44	ES113			22.95	14.88	8.07				
G64036	S45	ES51			22.67	13.66	9.01				
61651	S47	EB1			24.4	14.64	9.76				
G63610	S47	EB1			21.95	13.17	8.78				
61592	S47	EB1			21.45	13.17	8.28				
81937	S47	EB1			21.44	13.18	8.26				
G63884	S47	EB13			14.72	9.78	4.94				
77815	S47	ES64			21.97	13.2	8.77				
G63815	S47	ES64			21.95	13.17	8.78				
61662	S47	ES64			12.23	8.45	3.78				
G63813	S47	ES64			12.23	8.45	3.78				
G64027	S47	ES118			13.62	8.74	4.88				
69450	S48	EB5			26.25	16	10.25				
69907	S50	ES113			23.35	15.16	8.19				
69462	S50	ES80			24.11	15.01	9.10				

\* Damping force, in pounds, to either extend or collapse the shock absorber at an average operating velocity. Fuerza de amortiguación en libras para extender o comprimir el amortiguador a una velocidad de operación promedio. La puissance d'amortissement en poids de l'amortisseur, soit comprimé, soit détendu, à une vitesse de fonctionnement moyenne.

† At bumper contact / Al contacto con el tope de goma / Au contact avec le butoir

## ESPECIFICACIONES POR TIPO DE MONTAJE

GRC	Montajes		Calibre de Pistón	Imagen de Diámetro Exterior	Longitudes [in]			Polvera	Tope Hidráulico	Fuerza*	
	Superior	Inferior			Extendido	Comprimido	Carrera			Rebote	Compresión
G64049	S51	ES55			14.96	11.65	3.31				
69901	S52	ES143			16.69	10.51	6.18				
G64037	S55	ES147			26.37	15.47	10.9				
G64008	S57	ES26			21.79	13.6	8.19				
69590	S58	ES59			17.82	11.21	6.61				
G63885	S59	ES36			22.24	13.56	8.68				
70020	S60	ES53			21.89	13.14	8.75				
G64043	S61				14.09	9.68	4.41				
61611	S62	BP7			15.48	9.95	5.53				
81912	S62	BP7			15.48	9.87	5.61				
G63714	S62	BP7			15.39	9.86	5.53				
58714	S62	BP7			15.26	9.98	5.28				
G63716	S62	ES26			16.39	9.86	6.53				
58716	S62	ES26			15.74	10.37	5.37				
61613	S62	ES26			15.48	9.95	5.53				
81914	S62	ES26			15.48	9.87	5.61				
77967	S62	ES34			20.75	13.13	7.62				
G63969	S62	ES34			20.75	13.31	7.44				
61714	S62	ES77			23.36	14.22	9.14				
G64011	S62	ES87			23.36	14.21	9.15				
G64038	S63	ES69			24.48	15.07	9.41				
70000	S64	ES113			19.57	12.09	7.48				
G64046	S65	ES93			18.62	14.72	3.9				
69998	S67	ES92			17.91	14.09	3.82				
49254	S69	ES15			17.86	12.45	5.41				
81935	S70	ES41			24.19	15.93	8.26				
G51759	SS2				23.25	15.12	8.12				
G51746	SS2				22.12	17.37	4.75				
G56592	SS2				20.75	15.75	5				
G56596	SS2				18.25	13.50	4.75				
G56591	SS2				17.5	12.12	5.37				
G51740	SS4				24.5	19	5.50				
G51743	SS4				22	18.12	3.88				
G51760	SS6				25.17	19.37	5.8				
G51761	SS6				25.17	19.37	5.8				
G51758	SS6				21.5	15.34	5.85				
G51826					28.54	20.47	8.07				
G56759					27.75	14.50	13.25				
70056					27.67	18.54	9.13				
G51915					27.56	19.32	8.23				
G51805					27.13	16.61	10.52				
G56712					27.12	17.05	10.07				
G55776					27.1	16.30	10.8				

\* Damping force, in pounds, to either extend or collapse the shock absorber at an average operating velocity. Fuerza de amortiguación en libras para extender o comprimir el amortiguador a una velocidad de operación promedio. La puissance d'amortissement en poids de l'amortisseur, soit comprimé, doit détendu, à une vitesse de fonctionnement moyenne.

## ESPECIFICACIONES POR TIPO DE MONTAJE

GRC	Montajes		Calibre de Pistón	Imagen de Diámetro Exterior	Longitudes [in]			Polvera	Tope Hidráulico	Fuerza*	
	Superior	Inferior			Extendido	Comprimido	Carrera			Rebote	Compresión
G51733					26.76	16.68	10.08				
70052					26.41	16.18	10.23				
G52203					26.33	17.95	8.38				
G52204					26.33	17.95	8.38				
70032					26.18	15.31	10.87				
G51804					26.18	15.83	10.35				
G44713					26.08	18.74	7.34				
G52210					25.7	17	8.69				
14073					25.63	16.61	9.02				
G44969					25.61	18.00	7.61				
G56579					25.5	17.12	8.37				
G56580					25.5	17.12	8.37				
70028					25.39	16.42	8.98				
G56588					25.37	18.00	7.37				
G56589					25.37	18.00	7.37				
G56624					25.37	18.00	7.37				
G56625					25.37	18.00	7.37				
G52182					25.35	16.18	9.17				
G52183					25.35	16.18	9.17				
G52253					25.35	16.57	8.77				
G52254					25.35	16.57	8.77				
G52260					25.31	17.28	8.02				
G52261					25.31	17.28	8.02				
G55871					25.31	16.56	8.75				
G56593					25.25	17.37	7.87				
G44991					25.24	18.24	7				
G44920					25.22	18.02	7.2				
G44941					25.17	18.67	6.5				
G44867					25.16	18.73	6.43				
G56545					25.12	17.5	7.62				
G56546					25.12	17.5	7.62				
G55952					25.06	16.11	8.95				
G64047					25.03	15	10.03				
G52178					25	16.57	8.43				
G52179					25	16.57	8.43				
G56568					25	17.75	7.25				
G56601					25	17.75	7.25				
G44477					24.98	16.77	8.21				
G51947					24.96	19.29	5.67				
G51948					24.96	19.29	5.67				
G51721					24.88	17.95	6.94				
G51829					24.88	15.75	9.13				
G52030					24.88	17.95	6.93				

\* Damping force, in pounds, to either extend or collapse the shock absorber at an average operating velocity. Fuerza de amortiguación en libras para extender o comprimir el amortiguador a una velocidad de operación promedio. La puissance d'amortissement en poids de l'amortisseur, soit comprimé, soit détendu, à une vitesse de fonctionnement moyenne.

## ESPECIFICACIONES POR TIPO DE MONTAJE

GRC	Montajes		Calibre de Pistón	Imagen de Diámetro Exterior	Longitudes [in]			Polvera	Tope Hidráulico	Fuerza*	
	Superior	Inferior			Extendido	Comprimido	Carrera			Rebote	Compresión
G52031					24.88	17.95	6.93				
G51847					24.8	17.04	7.76				
G44990					24.79	16.89	7.90				
G55665					24.78	16.33	8.45				
51022					24.76	16.75	8.01				
G51022					24.76	16.75	8.01				
G55786					24.75	16.50	8.25				
G55796					24.75	16.50	8.25				
G52150					24.68	16.69	7.99				
G52151					24.68	16.69	7.99				
G44745					24.66	17.48	7.18				
G44776					24.66	16.77	7.90				
G55693					24.59	15.59	9				
G51738					24.57	17.09	7.48				
G52088					24.56	14.625	9.94				
G44775					24.55	17.48	7.08				
49255					24.54	14.66	9.87				
G55805					24.5	18.00	6.5				
G51249					24.48	16.97	7.51				
G51268					24.48	16.97	7.51				
G51885					24.44	15.39	9.05				
G51783					24.41	14.45	9.96				
G55893					24.41	16.46	7.95				
G55894					24.41	16.46	7.95				
G55769					24.35	15.03	9.32				
G56734					24.31	17.32	6.99				
G56735					24.31	17.32	6.99				
G44856					24.24	16.79	7.45				
G44752					24.22	17.81	6.41				
G51188					24.21	14.38	9.83				
G51192					24.21	14.38	9.84				
G52103					24.13	15.82	8.31				
G52104					24.13	15.82	8.31				
G52140					24.13	16.97	7.16				
G52141					24.13	16.97	7.16				
G55551					24.1	14.50	9.6				
G56602					24.06	16.93	7.13				
G56603					24.06	16.93	7.13				
G51813					23.98	19.21	4.77				
G51814					23.98	19.21	4.77				
G44766					23.9	16.12	7.78				
G44947					23.9	16.55	7.35				
70055					23.89	14.84	9.05				

\* Damping force, in pounds, to either extend or collapse the shock absorber at an average operating velocity. Fuerza de amortiguación en libras para extender o comprimir el amortiguador a una velocidad de operación promedio. La puissance d'amortissement en poids de l'amortisseur, soit comprimé, soit détendu, à une vitesse de fonctionnement moyenne.



## ESPECIFICACIONES POR TIPO DE MONTAJE

GRC	Montajes		Calibre de Pistón	Imagen de Diámetro Exterior	Longitudes [in]			Polvera	Tope Hidráulico	Fuerza*	
	Superior	Inferior			Extendido	Comprimido	Carrera			Rebote	Compresión
G44898					23.87	16.14	7.73				
70036					23.86	14.49	9.36				
G51033					23.85	15.59	8.26				
G56797					23.82	16.54	7.28				
70053					23.81	14.52	9.28				
G51905					23.74	17.79	5.95				
G56730					23.72	16.95	6.77				
G56731					23.72	16.95	6.77				
77971					23.64	14.70	8.94				
G51100					23.62	15.9	7.72				
G44926					23.6	15.77	7.83				
G56798					23.54	16.34	7.2				
G51747					23.51	14.91	8.61				
G52257					23.5	15.59	7.91				
G52258					23.5	15.59	7.91				
G56574					23.5	16.00	7.5				
G56575					23.5	16.00	7.5				
G44938					23.49	16.28	7.21				
G51912					23.43	15.79	7.64				
G51913					23.43	15.79	7.64				
G51039					23.41	15.28	8.14				
70024					23.39	19.48	3.9				
G56536					23.39	15.00	8.39				
G56537					23.39	15.00	8.39				
G56538					23.39	15.00	8.39				
G55856					23.37	14.26	9.11				
G51017					23.31	14.55	8.76				
G51919					23.31	15.79	7.52				
G56736					23.31	16.65	6.66				
G56739					23.31	16.65	6.66				
G52105					23.3	16.57	6.73				
G52106					23.3	16.57	6.73				
G52127					23.3	15.6	7.7				
G52128					23.3	15.6	7.7				
G55821					23.3	15.95	7.35				
G56681					23.3	15.26	8.04				
G56682					23.3	15.26	8.04				
G51705					23.28	14.49	8.78				
G56821					23.27	15.90	7.36				
G56822					23.27	15.90	7.36				
G51855					23.26	17.55	5.7				
G52187					23.26	14.8	8.46				
G52188					23.26	14.8	8.46				

\* Damping force, in pounds, to either extend or collapse the shock absorber at an average operating velocity. Fuerza de amortiguación en libras para extender o comprimir el amortiguador a una velocidad de operación promedio. La puissance d'amortissement en poids de l'amortisseur, soit comprimé, doit détendu, à une vitesse de fonctionnement moyenne.

## ESPECIFICACIONES POR TIPO DE MONTAJE

GRC	Montajes		Calibre de Pistón	Imagen de Diámetro Exterior	Longitudes [in]			Polvera	Tope Hidráulico	Fuerza*	
	Superior	Inferior			Extendido	Comprimido	Carrera			Rebote	Compresión
G55831					23.26	15.67	7.59				
G56763					23.25	15.75	7.5				
G56764					23.25	15.75	7.5				
G51030					23.24	14.72	8.53				
G51216					23.23	15.35	7.88				
G55527					23.23	16.54	6.69				
G52107					23.22	16.18	7.04				
G52108					23.22	16.18	7.04				
G52244					23.15	15.82	7.33				
G44868					23.14	17.33	5.82				
G55949					23.13	16.09	7.05				
70038					23.11	15.67	7.44				
G51710					23.08	16.02	7.06				
G55757					23.06	14.81	8.25				
G51799					23.03	14.65	8.38				
G52249					23.03	16.85	6.18				
G52250					23.03	16.85	6.18				
42952					23	13.89	9.11				
G51892					23	15.86	7.14				
G52158					23	15.94	7.06				
G52159					23	15.94	7.06				
G56561					23	16.37	6.62				
G56562					23	16.37	6.62				
G55929					22.99	15.12	7.87				
G55930					22.99	15.12	7.87				
G44862					22.98	16.78	6.2				
G55867					22.96	14.95	8.01				
G55868					22.96	14.95	8.01				
70034					22.95	17.39	5.55				
G56732					22.91	15.41	7.50				
G56733					22.91	15.41	7.50				
G55825					22.88	17.33	5.55				
G51097					22.83	18.07	4.76				
G51101					22.83	18.07	4.76				
G51900					22.83	14.92	7.91				
G52081					22.83	16.3	6.53				
G52082					22.83	16.3	6.53				
G44493					22.8	17.92	4.88				
G44497					22.8	17.97	4.83				
G52026					22.8	14.84	7.96				
G52027					22.8	14.84	7.96				
G55729					22.78	14.16	8.62				
G52184					22.75	14.96	7.79				

\* Damping force, in pounds, to either extend or collapse the shock absorber at an average operating velocity. Fuerza de amortiguación en libras para extender o comprimir el amortiguador a una velocidad de operación promedio. La puissance d'amortissement en poids de l'amortisseur, soit comprimé, soit détendu, à une vitesse de fonctionnement moyenne.

## ESPECIFICACIONES POR TIPO DE MONTAJE

GRC	Montajes		Calibre de Pistón	Imagen de Diámetro Exterior	Longitudes [in]			Polvera	Tope Hidráulico	Fuerza*	
	Superior	Inferior			Extendido	Comprimido	Carrera			Rebote	Compresión
G52185					22.75	14.96	7.79				
G55752					22.75	14.63	8.12				
G52065					22.72	15.39	7.32				
G52131					22.71	15.74	6.97				
G44724					22.68	14.95	7.73				
G44937					22.68	16.53	6.16				
G56566					22.68	15.31	7.37				
G51256					22.66	15.45	7.22				
G64087					22.63	13.78	8.85				
G56615					22.62	16.00	6.62				
G56616					22.62	16.00	6.62				
G56553					22.58	14.4	8.18				
G56554					22.58	14.4	8.18				
69995					22.57	13.91	8.66				
77973					22.57	14.41	8.16				
G51731					22.56	15.1	7.46				
G51924					22.56	15.28	7.28				
G56687					22.56	15.98	6.58				
G56688					22.56	15.98	6.58				
70068					22.51	14.88	7.63				
G52201					22.51	15.94	6.57				
G52202					22.51	15.94	6.57				
G56523					22.5	14.00	8.5				
G56691					22.5	14.75	7.75				
G55603					22.49	14.15	8.34				
G51046					22.48	15.22	7.26				
G51825					22.48	16.1	6.38				
G55934					22.48	14.00	8.48				
G51013					22.47	14.46	8.01				
G55931					22.47	14.00					
G51706					22.46	14.93	7.54				
630811			1-3/16"		22.45	14.1	8.35	NO	NO		
632147			1-3/16"		22.45	14.1	8.35	NO	NO		
70033					22.44	15.51	6.93				
G52333					22.44	13.78	8.66				
G52334					22.44	13.78	8.66				
G44773					22.42	15.52	6.9				
G51901					22.4	19.32	3.07				
G56897					22.40	14.21	8.19				
G56884					22.34	14.9	7.44				
G56885					22.34	14.9	7.44				
G44850					22.3	15.42	6.88				
G56599					22.28	17.20	5.08				

\* Damping force, in pounds, to either extend or collapse the shock absorber at an average operating velocity. Fuerza de amortiguación en libras para extender o comprimir el amortiguador a una velocidad de operación promedio. La puissance d'amortissement en poids de l'amortisseur, soit comprimé, doit détendu, à une vitesse de fonctionnement moyenne.

## ESPECIFICACIONES POR TIPO DE MONTAJE

GRC	Montajes		Calibre de Pistón	Imagen de Diámetro Exterior	Longitudes [in]			Polvera	Tope Hidráulico	Fuerza*	
	Superior	Inferior			Extendido	Comprimido	Carrera			Rebote	Compresión
G56524					22.25	14.00	8.25				
G56770					22.25	17.12	5.12				
G56771					22.25	17.12	5.12				
70061					22.24	14.09	8.14				
70059					22.20	13.77	8.43				
G52008					22.2	15.04	7.16				
G52009					22.2	15.04	7.16				
G52162					22.2	14.13	8.07				
G52163					22.2	14.13	8.07				
G44450					22.17	14.55	7.62				
G55518					22.14	13.82	8.32				
G51832					22.13	17.48	4.65				
G52148					22.12	14.76	7.36				
G52149					22.12	14.76	7.36				
G56571					22.12	14.12	8				
G56637					22.12	14.12	8				
G56640					22.12	14.37	7.75				
G56641					22.12	14.37	7.75				
G51099					22.05	18.19	3.86				
G52270					22.05	16.34	5.71				
G52271					22.05	16.34	5.71				
G52123					22.01	14.84	7.17				
G52124					22.01	14.84	7.17				
G51031					22	14.50	7.5				
G51713					22	15.69	6.31				
G52125					22	14.13	7.87				
G56815					22	15.37	6.62				
G56816					22	15.37	6.62				
G52000					21.97	15.35	6.62				
G52001					21.97	15.35	6.62				
G52002					21.97	15.39	6.58				
G52003					21.97	15.39	6.58				
G44735					21.95	14.35	7.6				
G51735					21.93	14.41	7.52				
G51807					21.93	17.48	4.45				
G56903					21.92	15.19	6.74				
G44934					21.90	15.20	6.71				
70031					21.89	14.41	7.48				
G52064					21.875	14.125	7.75				
G51007					21.87	13.86	8.01				
G56533					21.87	14.12	7.75				
G56534					21.87	14.12	7.75				
G52043					21.85	14.53	7.32				

\* Damping force, in pounds, to either extend or collapse the shock absorber at an average operating velocity. Fuerza de amortiguación en libras para extender o comprimir el amortiguador a una velocidad de operación promedio. La puissance d'amortissement en poids de l'amortisseur, soit comprimé, soit détendu, à une vitesse de fonctionnement moyenne.

## ESPECIFICACIONES POR TIPO DE MONTAJE

GRC	Montajes		Calibre de Pistón	Imagen de Diámetro Exterior	Longitudes [in]			Polvera	Tope Hidráulico	Fuerza*	
	Superior	Inferior			Extendido	Comprimido	Carrera			Rebote	Compresión
G52180					21.85	15.11	6.74				
G52181					21.85	15.11	6.74				
70023					21.81	15.94	5.87				
G51060					21.81	14.44	7.37				
42459					21.78	13.42	8.36				
44902					21.78	14.37					
G44802					21.78	15.17	6.61				
G44902					21.78	14.37	7.41				
G51953					21.77	19.32	2.44				
G51954					21.77	19.32	2.44				
G52017					21.77	13.9	7.87				
G52018					21.77	13.9	7.87				
G52152					21.77	13.93	7.84				
G52153					21.77	13.93	7.84				
G44997					21.76	14.76	7				
G55933					21.75	14.00					
G56769					21.75	14.50	7.25				
G51232					21.73	14.97	6.76				
G55993					21.73	15.16	6.57				
G55994					21.73	15.16	6.57				
G56813					21.73	15.75	5.98				
G56814					21.73	15.75	5.98				
G55865					21.7	15.63	6.08				
G55866					21.7	15.63	6.08				
G51704					21.69	16.62	5.07				
G52117					21.69	14.76	6.93				
G52118					21.69	14.76	6.93				
G51769					21.61	17.67	3.94				
G52168					21.61	14.17	7.44				
G52169					21.61	14.17	7.44				
G52173					21.61	15.23	6.38				
G52174					21.61	15.23	6.38				
G52262					21.61	13.7	7.91				
G52263					21.61	13.7	7.91				
G55733					21.61	13.82	7.79				
42508					21.6	13.34	8.26				
G56707					21.6	13.77	7.84				
70049					21.57	15.08	6.5				
G51864					21.57	17.16	4.41				
G56543					21.55	15.18	6.38				
G56544					21.55	15.18	6.38				
G52032					21.54	14.13	7.41				
G52033					21.54	14.13	7.41				

\* Damping force, in pounds, to either extend or collapse the shock absorber at an average operating velocity. Fuerza de amortiguación en libras para extender o comprimir el amortiguador a una velocidad de operación promedio. La puissance d'amortissement en poids de l'amortisseur, soit comprimé, soit détendu, à une vitesse de fonctionnement moyenne.

## ESPECIFICACIONES POR TIPO DE MONTAJE

GRC	Montajes		Calibre de Pistón	Imagen de Diámetro Exterior	Longitudes [in]			Polvera	Tope Hidráulico	Fuerza*	
	Superior	Inferior			Extendido	Comprimido	Carrera			Rebote	Compresión
G55859					21.52	12.02	9.5				
G55860					21.52	12.02	9.5				
G51729					21.5	14.26	7.24				
G52268					21.5	14.72	6.77				
G52269					21.5	14.72	6.77				
G56760					21.5	17.00	4.5				
G56761					21.5	17.00	4.5				
G51330					21.46	13.43	8.03				
G52041					21.46	15.16	6.30				
G52335					21.46	14.06	7.4				
G52336					21.46	14.06	7.4				
G44986					21.45	14.95	6.5				
G52021					21.42	13.66	7.76				
G52022					21.42	13.66	7.76				
G51848					21.41	13.66	7.75				
G52112					21.41	14	7.41				
G52113					21.41	14	7.41				
70041					21.38	14.8	6.57				
G51190					21.38	15.35	6.03				
G52034					21.38	14.41	6.97				
G52035					21.38	14.41	6.97				
G55927					21.38	12.82					
G55928					21.38	12.82					
G56888					21.38	14.49	6.89				
G56889					21.38	14.49	6.89				
G56778					21.37	14.37	7				
G44774					21.36	14.13	7.23				
G44869					21.36	15.65	5.71				
G51739					21.36	16.79	4.57				
70037					21.34	13.7	7.64				
G51907					21.34	13.74	7.6				
G52040					21.34	14.65	6.69				
G51063					21.31	13.05	8.26				
G51181					21.31	13.36	7.95				
G51253					21.3	14.30	7				
G51254					21.3	14.30	7				
G51165					21.26	13.44	7.82				
G55784					21.25	14.00	7.25				
G55785					21.25	14.00	7.25				
G51229					21.23	14.97	6.26				
G51870					21.22	15.43					
G52166					21.22	13.81	7.41				
G52167					21.22	13.81	7.41				

\* Damping force, in pounds, to either extend or collapse the shock absorber at an average operating velocity. Fuerza de amortiguación en libras para extender o comprimir el amortiguador a una velocidad de operación promedio. La puissance d'amortissement en poids de l'amortisseur, soit comprimé, soit détendu, à une vitesse de fonctionnement moyenne.

## ESPECIFICACIONES POR TIPO DE MONTAJE

GRC	Montajes		Calibre de Pistón	Imagen de Diámetro Exterior	Longitudes [in]			Polvera	Tope Hidráulico	Fuerza*	
	Superior	Inferior			Extendido	Comprimido	Carrera			Rebote	Compresión
G51191					21.18	15.07	6.11				
G51856					21.18	15.11	6.07				
G51725					21.12	14.62	6.5				
G51712					21.1	14.80	6.3				
G56899					21.1	14.8	6.30				
G44936					21.06	14.69	6.37				
G56838					21.06	17.99	3.07				
G44800					21.05	15.24	5.82				
G51720					21.05	16.14	4.91				
G44767					21.04	14.21	6.84				
G52004					21.02	14.69	6.33				
G52007					21.02	14.69	6.33				
51006					21.01	13.25	7.76				
G44803					21.01	14.38	6.63				
G51006					21.01	13.00	8.01				
G56807					21	14.25	6.75				
G51841					20.98	14.29	6.69				
G52314					20.98	16.34	4.65				
G56558					20.98	14.44	6.54				
G56559					20.98	14.44	6.54				
G56894					20.98	14.29	6.69				
G55975					20.97	12.80	8.18				
G56675					20.95	12.25	8.7				
G56676					20.95	12.25	8.7				
G56728					20.95	12.25	8.7				
G56729					20.95	12.25	8.7				
G55533					20.94	13.65	7.29				
G44999					20.93	14.23	6.7				
G44968					20.91	14.41	6.5				
G51922					20.91	16.64	4.25				
G52170					20.9	16.02	4.88				
G52171					20.9	16.02	4.88				
G55991					20.87	14.53	6.34				
G51865					20.86	16.45	4.41				
G55675					20.84	12.64	8.20				
G55676					20.84	12.64	8.2				
G51802					20.83	14.09	6.74				
G52282					20.83	13.86	6.97				
G52283					20.83	13.86	6.97				
G44783					20.81	13.66	7.15				
G51193					20.81	14.09	6.72				
G56667					20.81	13.23	7.58				
G56668					20.81	13.23	7.58				

\* Damping force, in pounds, to either extend or collapse the shock absorber at an average operating velocity. Fuerza de amortiguación en libras para extender o comprimir el amortiguador a una velocidad de operación promedio. La puissance d'amortissement en poids de l'amortisseur, soit comprimé, soit détendu, à une vitesse de fonctionnement moyenne.

## ESPECIFICACIONES POR TIPO DE MONTAJE

GRC	Montajes		Calibre de Pistón	Imagen de Diámetro Exterior	Longitudes [in]			Polvera	Tope Hidráulico	Fuerza*	
	Superior	Inferior			Extendido	Comprimido	Carrera			Rebote	Compresión
G55588					20.8	13.05	7.75				
G51078					20.79	13.69	7.1				
70060					20.78	17.28	3.5				
G52247					20.78	13.66	7.12				
G52248					20.78	13.66	7.12				
G56555					20.77	14.25	6.53				
G56556					20.77	14.25	6.53				
G55923					20.75	13.74	7.01				
G55924					20.75	13.74	7.01				
69924					20.74	13.48	7.26				
G44495					20.74	14.65	6.09				
G56581					20.74	13.59	7.15				
G56582					20.74	13.59	7.15				
G56631					20.74	13.59	7.15				
G56632					20.74	13.59	7.15				
G56604					20.71	15.98	4.73				
G56605					20.71	15.98	4.73				
G52066					20.7	13.62	7.08				
G52096					20.7	13.42	7.28				
G52097					20.7	13.42	7.28				
G55681					20.69	14.36	6.34				
G52087					20.68	14.625	6.06				
G55737					20.68	13.15	7.53				
G55738					20.68	13.15	7.53				
G55510					20.67	13.55	7.12				
G56796					20.67	14.21	6.46				
G244002					20.66	14.21	6.44				
G52172					20.66	16.32	4.33				
G44943					20.64	13.91	6.73				
G55925					20.63	14.21	6.42				
G55926					20.63	14.21	6.42				
G56649					20.63	13.98	6.65				
G56650					20.63	13.98	6.65				
G51703					20.6	16.65	3.95				
G52098					20.6	13.85	6.75				
G56541					20.59	12.48	8.11				
G56542					20.59	12.48	8.11				
G44461					20.58	14.67	5.91				
G44918					20.57	14.59	5.98				
G55579					20.56	16.32	4.23				
G56572					20.55	13.66	6.89				
G55708					20.54	14.00	6.54				
G52013					20.52	13.5	7.02				

\* Damping force, in pounds, to either extend or collapse the shock absorber at an average operating velocity. Fuerza de amortiguación en libras para extender o comprimir el amortiguador a una velocidad de operación promedio. La puissance d'amortissement en poids de l'amortisseur, soit comprimé, soit détendu, à une vitesse de fonctionnement moyenne.



## ESPECIFICACIONES POR TIPO DE MONTAJE

GRC	Montajes		Calibre de Pistón	Imagen de Diámetro Exterior	Longitudes [in]			Polvera	Tope Hidráulico	Fuerza*	
	Superior	Inferior			Extendido	Comprimido	Carrera			Rebote	Compresión
G52014					20.52	13.5	7.02				
G55712					20.52	14.00	6.52				
70045					20.51	14.37	6.14				
G52245					20.51	13.39	7.13				
G52246					20.51	13.39	7.13				
G56840					20.51	13.63	6.88				
G56841					20.51	13.63	6.88				
G55714					20.5	14.00	6.5				
G56512					20.5	13.75	6.75				
G56513					20.5	13.75	6.75				
G52028					20.47	12.68	7.79				
G52029					20.47	13.07	7.40				
G52205					20.47	17.67	2.8				
G55745					20.47	13.27	7.2				
G55883					20.47	11.81	8.66				
G55884					20.47	11.81	8.66				
G56890					20.47	13.31	7.16				
G56891					20.47	13.31	7.16				
G51709					20.44	15.32	5.12				
G55589					20.44	12.69	7.76				
G56882					20.44	13.69	6.75				
G56883					20.44	13.69	6.75				
G35066					20.43	13.78	6.65				
G51874					20.43	16.41	4.01				
G55901					20.41	13.65	6.76				
G52069					20.39	15.12	5.28				
G52070					20.39	15.12	5.28				
G55516					20.39	13.41	6.99				
G56612					20.39	14.21	6.18				
G44940					20.37	14.14	6.24				
G51197					20.37	15.76	4.61				
G51756					20.37	17.75	2.62				
G51770					20.37	17.75	2.62				
G55507					20.37	14.08	6.29				
G56504					20.37	13.14	7.24				
G44451					20.35	13.92	6.43				
G52144					20.35	15.39	4.96				
G52145					20.35	15.39	4.96				
G55772					20.35	13.85	6.5				
G55668					20.34	12.83	7.51				
G55669					20.34	12.83	7.51				
G44459					20.32	13.41	6.91				
55746					20.31	11.56	8.75				

\* Damping force, in pounds, to either extend or collapse the shock absorber at an average operating velocity. Fuerza de amortiguación en libras para extender o comprimir el amortiguador a una velocidad de operación promedio. La puissance d'amortissement en poids de l'amortisseur, soit comprimé, soit détendu, à une vitesse de fonctionnement moyenne.

## ESPECIFICACIONES POR TIPO DE MONTAJE

GRC	Montajes		Calibre de Pistón	Imagen de Diámetro Exterior	Longitudes [in]			Polvera	Tope Hidráulico	Fuerza*	
	Superior	Inferior			Extendido	Comprimido	Carrera			Rebote	Compresión
G55746					20.31	11.56	8.75				
G51863					20.30	12.48	7.83				
G55788					20.28	14.69	5.59				
G56648					20.28	13.50	6.77				
G55817					20.25	12.56	7.7				
G56784					20.25	14.25	6				
G56785					20.25	14.25	6				
G56791					20.25	16.12	4.13				
70163					20.23	12.82	7.41				
G51424					20.23	12.97	7.26				
G51923					20.23	14.69	5.55				
G55976					20.23	12.12	8.11				
G55977					20.23	12.12	8.11				
55976					20.22	12.11	8.11				
55977					20.22	12.11	8.11				
G56516					20.22	14.02	6.2				
G56517					20.22	13.94	6.28				
G55896					20.2	14.1	6.10				
G56535					20.2	12.83	7.37				
G55616					20.19	13.73	6.46				
G55892					20.19	14.09	6.9				
G56501					20.18	12.01	8.18				
G44998					20.17	13.86	6.31				
G51027					20.17	12.41	7.76				
G51047					20.17	12.41	7.76				
G55848					20.16	11.87	8.30				
G55707					20.11	14.24	5.87				
G56886					20.09	13.79	6.30				
G56887					20.09	13.79	6.30				
G52048					20.08	14.13	5.94				
G56633					20.08	12.52	7.56				
G56634					20.08	12.52	7.56				
G44748					20.07	14.14	5.93				
G51906					20.07	14.49	5.59				
G52038					20.04	13.11	6.93				
G52039					20.04	13.11	6.93				
G56719					20.04	13.26	6.78				
G55529					20.03	12.50	7.53				
G56594					20.03	15.23	4.8				
G56595					20.03	15.23	4.81				
G56655					20.03	13.38	6.65				
G55685					20.01	13.49	6.52				
G56503					20.01	14.25	5.76				

\* Damping force, in pounds, to either extend or collapse the shock absorber at an average operating velocity. Fuerza de amortiguación en libras para extender o comprimir el amortiguador a una velocidad de operación promedio. La puissance d'amortissement en poids de l'amortisseur, soit comprimé, soit détendu, à une vitesse de fonctionnement moyenne.

## ESPECIFICACIONES POR TIPO DE MONTAJE

GRC	Montajes		Calibre de Pistón	Imagen de Diámetro Exterior	Longitudes [in]			Polvera	Tope Hidráulico	Fuerza*	
	Superior	Inferior			Extendido	Comprimido	Carrera			Rebote	Compresión
G52011					20	13.54	6.46				
G55557					20	12.00	8				
G55580					20	12.50	7.5				
G55601					20	12.50	7.5				
G56810					20	13.50	6.5				
G51812					19.96	13.94	6.02				
G51860					19.96	16.29	3.67				
44763					19.95	13.82					
G44763					19.95	13.82	6.13				
G55606					19.95	12.47	7.48				
G55698					19.92	13.14	6.78				
G56573					19.87	13.50	6.37				
G56576					19.87	13.50	6.37				
G56677					19.87	13.37	6.5				
G56678					19.87	13.37	6.5				
G56765					19.87	14.25	5.62				
G56766					19.87	14.25	5.62				
G44994					19.84	14.20	5.64				
G51719					19.84	15.70	4.14				
G52023					19.84	13.54	6.30				
G52024					19.84	13.54	6.30				
G52156					19.84	12.59	7.25				
G52157					19.84	12.59	7.25				
G52227					19.84	13.93	5.91				
G52228					19.84	13.93	5.91				
G44903					19.81	13.59	6.22				
G51290					19.78	13.07	6.71				
G56547					19.76	12.89	6.87				
G56548					19.76	12.89	6.87				
G51744					19.75	15.5	4.25				
G56809					19.75	13.12	6.62				
G56598					19.74	15.23	4.51				
G44939					19.72	13.66	6.07				
G44982					19.72	13.66	6.07				
G52274					19.72	13.19	6.54				
G52275					19.72	13.19	6.54				
G44743					19.70	13.10	6.6				
G55697					19.7	13.19	6.51				
G51764					19.69	14.36	5.33				
G52160					19.68	13.15	6.53				
G52161					19.68	13.15	6.53				
55745					19.65	13.33	6.32				
G56606					19.65	13.23	6.42				

\* Damping force, in pounds, to either extend or collapse the shock absorber at an average operating velocity. Fuerza de amortiguación en libras para extender o comprimir el amortiguador a una velocidad de operación promedio. La puissance d'amortissement en poids de l'amortisseur, soit comprimé, doit détendu, à une vitesse de fonctionnement moyenne.

## ESPECIFICACIONES POR TIPO DE MONTAJE

GRC	Montajes		Calibre de Pistón	Imagen de Diámetro Exterior	Longitudes [in]			Polvera	Tope Hidráulico	Fuerza*	
	Superior	Inferior			Extendido	Comprimido	Carrera			Rebote	Compresión
G52237					19.64	14.92	4.72				
G52238					19.64	14.92	4.72				
G55800					19.63	12.38	7.25				
G56539					19.62	13.37	6.25				
G56540					19.62	13.37	6.25				
G56660					19.62	13.87	5.75				
G56661					19.62	13.87	5.75				
G52025					19.61	13.15	6.46				
G55661					19.57	11.76	7.81				
G55662					19.57	11.76	7.81				
G51836					19.53	16.69	2.83				
G51883					19.52	12.48	7.04				
G55960					19.51	13.60	5.91				
G55978					19.51	13.60	5.91				
G56792					19.5	16.12	3.38				
G51186					19.48	12.72	6.76				
G52264					19.48	12.72	6.77				
G52265					19.48	12.72	6.77				
G52280					19.48	12.87	6.61				
G52281					19.48	12.87	6.61				
G56842					19.47	13.41					
G56843					19.47	13.41					
G44747					19.46	13.57	5.89				
G52278					19.45	13.5	5.94				
G52279					19.45	13.5	5.94				
G56754					19.45	12.76	6.69				
G56755					19.45	12.76	6.69				
G52199					19.44	14.76	4.68				
G52200					19.44	14.76	4.68				
G55715					19.42	13.5	5.92				
G55590					19.41	13.04	6.37				
G55716					19.38	12.38	7				
G52036					19.37	15.04	4.33				
G52037					19.37	15.04	4.33				
G56748					19.37	12.95	6.42				
G56781					19.37	14.00	5.37				
G56782					19.37	14.00	5.37				
G55509					19.36	13.35	6.01				
G55890					19.33	11.52	7.81				
G56839					19.33	13.42	5.91				
G52075					19.32	12.56	6.77				
G52076					19.32	12.56	6.77				
G55912					19.32	12.31	7.02				

\* Damping force, in pounds, to either extend or collapse the shock absorber at an average operating velocity. Fuerza de amortiguación en libras para extender o comprimir el amortiguador a una velocidad de operación promedio. La puissance d'amortissement en poids de l'amortisseur, soit comprimé, soit détendu, à une vitesse de fonctionnement moyenne.

## ESPECIFICACIONES POR TIPO DE MONTAJE

GRC	Montajes		Calibre de Pistón	Imagen de Diámetro Exterior	Longitudes [in]			Polvera	Tope Hidráulico	Fuerza*	
	Superior	Inferior			Extendido	Comprimido	Carrera			Rebote	Compresión
G55913					19.32	12.31	7.02				
G51034					19.31	12.41	6.91				
G51170					19.31	12.41	6.9				
G51889					19.29	12.91	6.38				
G51890					19.29	12.91	6.38				
G52116					19.29	13.07	6.22				
G52154					19.29	12.52	6.77				
G52155					19.29	12.52	6.77				
G51724					19.28	13.69	5.59				
G55704					19.26	13.97	5.29				
G56585					19.25	12.87	6.37				
G56586					19.25	12.87	6.37				
G56611					19.25	12.97	6.28				
G55910					19.23	13.09	6.14				
G51837					19.21	13.39	5.83				
G51861					19.21	15.15	4.05				
G52206					19.21	13.18	6.03				
G52209					19.21	13.18	6.03				
G56983					19.21	12.60	6.61				
G44944					19.18	13.29	5.90				
G51810					19.17	13.27	5.90				
G51811					19.17	13.27	5.90				
G52019					19.17	12.64	6.53				
G52020					19.17	12.64	6.53				
G56742					19.17	12.36	6.81				
G56793					19.13	13	6.13				
G56794					19.13	13	6.13				
G55728					19.12	13.38	5.74				
G56569					19.12	12.25	6.87				
G56570					19.12	12.25	6.87				
G56621					19.12	13.00	6.12				
G56622					19.12	13.00	6.12				
G56626					19.12	13	6.12				
G56627					19.12	13	6.12				
G56689					19.12	13.12	6				
G56690					19.12	13.12	6				
G52193					19.09	14.29	4.8				
G52194					19.09	14.29	4.8				
G55692					19.09	12.55	6.54				
G56644					19.07	12.00	7.07				
G56645					19.07	12.00	7.07				
G56527					19.06	11.60	7.46				
G56528					19.06	11.60	7.46				

\* Damping force, in pounds, to either extend or collapse the shock absorber at an average operating velocity. Fuerza de amortiguación en libras para extender o comprimir el amortiguador a una velocidad de operación promedio. La puissance d'amortissement en poids de l'amortisseur, soit comprimé, soit détendu, à une vitesse de fonctionnement moyenne.

## ESPECIFICACIONES POR TIPO DE MONTAJE

GRC	Montajes		Calibre de Pistón	Imagen de Diámetro Exterior	Longitudes [in]			Polvera	Tope Hidráulico	Fuerza*	
	Superior	Inferior			Extendido	Comprimido	Carrera			Rebote	Compresión
G51842					19.05	12.75	6.30				
G55672					19.05	12.57	6.48				
G51838					19.02	12.72	6.3				
G52005					19.02	11.81	7.21				
G52006					19.02	11.81	7.21				
G55705					19.01	12.00	7.01				
G55828					19	13.00	6				
G55771					18.99	13.42	5.58				
G55525					18.97	12.97	6.01				
G55766					18.97	12.70	6.27				
G56520					18.95	12.56	6.39				
G51722					18.93	16.73	2.2				
G51723					18.93	16.73	2.2				
G55803					18.92	13.23	5.69				
G56721					18.91	11.48	7.43				
G56722					18.91	11.48	7.43				
G55782					18.89	13.02	5.87				
G56673					18.89	11.48	7.41				
G56674					18.89	11.48	7.41				
G51911					18.86	15	3.86				
G52015					18.86	13.35	5.51				
G52016					18.86	13.35	5.51				
G52346					18.86	13.31	5.55				
G52347					18.86	13.31	5.55				
G56895					18.86	12.36	6.5				
G56896					18.86	12.36	6.5				
G56836					18.84	13.12	5.72				
G56837					18.84	13.12	5.72				
G51252					18.82	12.02	6.8				
G52055					18.82	12.76	6.06				
G52056					18.82	12.76	6.06				
G56749					18.82	12.76	6.06				
G55732					18.8	12.97	5.83				
G51795					18.78	12.008	6.77				
G56694					18.78	11.06	7.72				
G44995					18.77	13.21	5.56				
G56708					18.77	10.85	7.92				
G56618					18.75	12.87	5.88				
G56619					18.75	12.87	5.88				
G56750					18.74	12.76	5.98				
G56751					18.74	12.76	5.98				
G56752					18.74	12.76	5.98				
G56753					18.74	12.76	5.98				

\* Damping force, in pounds, to either extend or collapse the shock absorber at an average operating velocity. Fuerza de amortiguación en libras para extender o comprimir el amortiguador a una velocidad de operación promedio. La puissance d'amortissement en poids de l'amortisseur, soit comprimé, doit détendu, à une vitesse de fonctionnement moyenne.

## ESPECIFICACIONES POR TIPO DE MONTAJE

GRC	Montajes		Calibre de Pistón	Imagen de Diámetro Exterior	Longitudes [in]			Polvera	Tope Hidráulico	Fuerza*	
	Superior	Inferior			Extendido	Comprimido	Carrera			Rebote	Compresión
G55652					18.73	12.25	6.49				
G55653					18.73	12.25	6.49				
69579					18.66	15.59	3.07				
G51204					18.63	14.83	3.8				
G56718					18.63	11.07	7.57				
G51857					18.62	12.24	6.38				
G51882					18.62	12.24	6.38				
G55878					18.61	11.02	7.59				
G56620					18.6	12.14	6.47				
G51839					18.58	13.34	5.24				
G55804					18.55	12.05	6.49				
G51896					18.54	14.09	4.45				
G51897					18.54	14.09	4.45				
G52079					18.54	12.44	6.10				
G52080					18.54	12.44	6.10				
G55706					18.53	12.72	5.81				
G55722					18.53	10.71	7.82				
G56714					18.53	10.62	7.91				
G51859					18.5	14.29	4.21				
G55847					18.5	12.00	6.5				
G55989					18.49	11.34	7.15				
G56701					18.49	11.34	7.15				
G52063					18.43	12.52	5.91				
G51880					18.42	12	6.42				
G52142					18.38	14.05	4.33				
G52143					18.38	14.05	4.33				
G56999					18.38	11.53	6.85				
G56531					18.37	12.62	5.75				
G56532					18.37	12.62	5.75				
56630					18.35	12.47	5.88				
G35098					18.35	12.46	5.89				
G56756					18.35	12.76	5.59				
G51909					18.3	12.68	5.63				
G52276					18.3	11.3	7.01				
G51949					18.27	14.49	3.78				
G55795					18.25	11.25	7				
G51869					18.23	13.7	4.53				
G55731					18.21	10.38	7.83				
G55719					18.2	11.36	6.84				
G51767					18.19	12.36	5.83				
G55932					18.16	11.62	6.54				
G51477					18.14	13.36	4.78				
G52110					18.14	11.96	6.19				

\* Damping force, in pounds, to either extend or collapse the shock absorber at an average operating velocity. Fuerza de amortiguación en libras para extender o comprimir el amortiguador a una velocidad de operación promedio. La puissance d'amortissement en poids de l'amortisseur, soit comprimé, soit détendu, à une vitesse de fonctionnement moyenne.

## ESPECIFICACIONES POR TIPO DE MONTAJE

GRC	Montajes		Calibre de Pistón	Imagen de Diámetro Exterior	Longitudes [in]			Polvera	Tope Hidráulico	Fuerza*	
	Superior	Inferior			Extendido	Comprimido	Carrera			Rebote	Compresión
G52111					18.14	11.96	6.19				
G55857					18.14	11.57	6.57				
G55858					18.14	11.57	6.57				
G51195					18.12	13.42	4.70				
G51771					18.12	13.12	5				
G51875					18.11	12.32	5.79				
G51876					18.11	12.32	5.79				
G52057					18.11	13.31	4.8				
G52058					18.11	13.31	4.8				
G51815					18.07	13.46	4.61				
G55726					18.06	13.19	4.87				
70040					18.03	11.38	6.65				
G51910					18.03	12.36	5.67				
G51077					18.02	12.75	5.27				
G55539					18.02	11.95	6.07				
G55974					18.01	11.14	6.88				
G56713					18.01	10.76	7.25				
G51180					18	12.00	6				
G51773					18	13.5	4.50				
G55819					18	13.40	4.6				
G51849					17.95	12.36	5.59				
G55990					17.93	11.32	6.61				
G55797					17.9	11.00	6.9				
G56703					17.90	10.85	7.05				
G56717					17.9	10.86	7.05				
G55511					17.89	11.85	6.05				
G55584					17.87	11.05	6.83				
G55727					17.87	10.23	7.63				
G56892					17.87	12.24	5.63				
G56893					17.87	12.24	5.63				
G51087					17.86	11.91	5.95				
G56664					17.86	12.45	5.41				
55991					17.85	11.52	6.33				
G56715					17.84	9.98	7.87				
70027					17.82	12.95	4.88				
G52129					17.82	11.49	6.34				
G52130					17.82	11.49	6.34				
G51189					17.81	12.18	5.63				
55713					17.8	11.44	6.36				
G51891					17.8	13.54	4.26				
G55713					17.79	11.43	6.36				
42520					17.77	13.29	4.48				
G56704					17.73	11.07	6.66				

\* Damping force, in pounds, to either extend or collapse the shock absorber at an average operating velocity. Fuerza de amortiguación en libras para extender o comprimir el amortiguador a una velocidad de operación promedio. La puissance d'amortissement en poids de l'amortisseur, soit comprimé, soit détendu, à une vitesse de fonctionnement moyenne.



## ESPECIFICACIONES POR TIPO DE MONTAJE

GRC	Montajes		Calibre de Pistón	Imagen de Diámetro Exterior	Longitudes [in]			Polvera	Tope Hidráulico	Fuerza*	
	Superior	Inferior			Extendido	Comprimido	Carrera			Rebote	Compresión
G56978					17.72	11.02	6.69				
G56979					17.72	11.02	6.69				
69726					17.7	13.54	4.16				
G55593					17.7	12.05	5.65				
G55594					17.7	12.05	5.65				
G51917					17.68	12.91	4.76				
G51918					17.68	12.91	4.76				
G51877					17.67	12.91	4.76				
G51878					17.67	12.91	4.76				
G55914					17.65	11.48	6.17				
G56669					17.65	10.57	7.09				
G56670					17.65	10.57	7.09				
G52136					17.63	11.57	6.06				
G52137					17.63	11.57	6.06				
G55970					17.63	11.90	5.73				
G55971					17.63	11.90	5.73				
G56705					17.63	11.28	6.36				
G56706					17.63	11.28	6.36				
G56720					17.63	11.28	6.36				
G56723					17.63	11.28	6.36				
G56724					17.63	11.28	6.36				
G51727					17.62	12.87	4.75				
G51868					17.56	13.35	4.21				
G56508					17.52	10.66	6.87				
G52121					17.51	13.3	4.21				
G52122					17.51	13.3	4.21				
14004					17.48	11.28	6.20				
G55724					17.46	12.41	5.05				
69580					17.45	11.15	6.3				
G55515					17.45	11.24	6.22				
G51908					17.44	11.3	6.14				
G55780					17.43	11.09	6.34				
G56716					17.43	10.89	6.54				
G55526					17.41	10.83	6.58				
55526					17.4	10.83	6.58				
G51757					17.37	13.12	4.25				
G55521					17.37	11.06	6.31				
G55663					17.34	11.26	6.09				
G55664					17.34	11.26	6.09				
G51955					17.32	14.33	2.99				
G56642					17.3	11.14	6.16				
G56643					17.3	11.14					
70005					17.28	11.57	5.71				

\* Damping force, in pounds, to either extend or collapse the shock absorber at an average operating velocity. Fuerza de amortiguación en libras para extender o comprimir el amortiguador a una velocidad de operación promedio. La puissance d'amortissement en poids de l'amortisseur, soit comprimé, soit détendu, à une vitesse de fonctionnement moyenne.

## ESPECIFICACIONES POR TIPO DE MONTAJE

GRC	Montajes		Calibre de Pistón	Imagen de Diámetro Exterior	Longitudes [in]			Polvera	Tope Hidráulico	Fuerza*	
	Superior	Inferior			Extendido	Comprimido	Carrera			Rebote	Compresión
G51794					17.28	11.06	6.22				
G52094					17.28	13.03	4.25				
G52095					17.28	13.03	4.25				
G51173					17.27	11.00	6.27				
G51711					17.25	14.75	2.5				
G55546					17.25	11.17	6.08				
G55801					17.25	10.25	7				
42577					17.23	10.87	6.36				
G55657					17.23	10.93	6.3				
G55658					17.23	10.93	6.3				
55657					17.22	10.93	6.3				
55658					17.22	10.93	6.3				
G56502					17.22	10.54	6.68				
G56506					17.22	10.54	6.68				
G56514					17.22	10.54	6.68				
42161					17.2	12.44	4.76				
G56700					17.19	10.57	6.62				
G56608					17.13	12.2	4.93				
G51737					17.12	12.50	4.62				
G51899					17.04	11.73	5.31				
G55680					17	12.25	4.75				
G55992					16.99	10.40	6.59				
55514					16.98	10.4	6.58				
G55505					16.98	10.40	6.58				
G55514					16.98	10.40	6.58				
G56775					16.98	9.9	7.08				
G56776					16.98	9.9	7.08				
G52138					16.96	11.02	5.94				
G52139					16.96	11.02	5.94				
G55591					16.94	10.76	6.18				
G56525					16.91	10.48	6.43				
G56526					16.91	10.48	6.43				
G56529					16.9	10.55	6.35				
G56530					16.9	10.55	6.35				
G51768					16.87	12.12	4.75				
G55920					16.87	11.13	5.74				
G55921					16.87	11.13	5.74				
G51184					16.85	10.70	6.15				
G51853					16.85	12	4.84				
G51854					16.85	12	4.84				
G55673					16.82	11.05	5.77				
G56509					16.82	10.66	6.17				
G51714					16.79	11.99	4.8				

\* Damping force, in pounds, to either extend or collapse the shock absorber at an average operating velocity. Fuerza de amortiguación en libras para extender o comprimir el amortiguador a una velocidad de operación promedio. La puissance d'amortissement en poids de l'amortisseur, soit comprimé, soit détendu, à une vitesse de fonctionnement moyenne.

## ESPECIFICACIONES POR TIPO DE MONTAJE

GRC	Montajes		Calibre de Pistón	Imagen de Diámetro Exterior	Longitudes [in]			Polvera	Tope Hidráulico	Fuerza*	
	Superior	Inferior			Extendido	Comprimido	Carrera			Rebote	Compresión
G55999					16.79	10.81	5.98				
G55870					16.78	11.56	5.22				
G55834					16.77	10.05	6.72				
G56565					16.77	11.81	4.96				
G51774					16.73	11.88	4.85				
70039					16.69	10.51	6.18				
G55602					16.68	9.69	6.99				
G55710					16.67	9.7	6.97				
G55531					16.66	10.10	6.56				
G55534					16.66	10.23	6.43				
G55544					16.66	10.26	6.4				
G55666					16.65	10.61	6.04				
G55667					16.65	10.61	6.04				
G55881					16.65	10.35	6.3				
G55882					16.65	10.35	6.3				
G56812					16.62	10.32	6.37				
G51718					16.61	11.41	5.2				
G51827					16.61	10.67	5.94				
G51828					16.61	10.67	5.94				
G55832					16.61	10.61	6				
G55833					16.61	10.61	6				
G55904					16.61	10.47	6.14				
G56551					16.6	10.42	6.18				
G56552					16.6	10.42	6.18				
G56635					16.6	10.42	6.18				
G56636					16.6	10.42	6.18				
G56817					16.59	10.9	5.69				
G55725					16.58	10.7	5.88				
G63841					16.58	11.05	5.5				
G51881					16.57	11.65	4.92				
G51898					16.57	12.09	4.49				
G56740					16.56	10.41	6.15				
G56741					16.56	10.41	6.15				
G51884					16.53	13.5	3.03				
G55512					16.52	9.76	6.76				
G55879					16.51	10.28	6.23				
G51736					16.5	11.50	5				
G55948					16.5	10.71	5.79				
56980					16.42	8.88	7.54				
G56522					16.41	9.98	6.43				
G55561					16.38	9.84	6.54				
G51279					16.37	11.07	5.3				
G55609					16.34	10.65	5.69				

\* Damping force, in pounds, to either extend or collapse the shock absorber at an average operating velocity. Fuerza de amortiguación en libras para extender o comprimir el amortiguador a una velocidad de operación promedio. La puissance d'amortissement en poids de l'amortisseur, soit comprimé, doit détendu, à une vitesse de fonctionnement moyenne.

## ESPECIFICACIONES POR TIPO DE MONTAJE

GRC	Montajes		Calibre de Pistón	Imagen de Diámetro Exterior	Longitudes [in]			Polvera	Tope Hidráulico	Fuerza*	
	Superior	Inferior			Extendido	Comprimido	Carrera			Rebote	Compresión
G55586					16.32	9.67	6.65				
G55615					16.26	11.06	5.2				
G55951					16.26	11.53	4.74				
G55958					16.26	11.53	4.74				
G52164					16.25	10.78	5.47				
G52165					16.25	10.78	5.47				
G51886					16.22	10.74	5.48				
G51904					16.22	11.5	4.72				
G55911					16.22	9.72	6.5				
G51230					16.2	10.98	5.22				
G55945					16.20	10.36	5.84				
69583					16.19	10.58	5.61				
G55610					16.17	10.90	5.27				
G55611					16.17	10.80	5.37				
G56515					16.15	8.44	7.71				
G56607					16.14	11.81	4.33				
G51182					16.13	10.33	5.8				
G51183					16.1	10.33	5.77				
G51850					16.1	11.06	5.04				
G55600					16.09	9.60	6.49				
G51264					16.01	11.28	4.73				
G55781					16	10.50	5.5				
G55787					16	10.25	5.75				
G55820					16	11.25	4.75				
G56587					16	11.75	4.25				
42094					15.98	10.37	5.61				
G55592					15.96	9.54	6.42				
G55587					15.93	10.07	5.86				
G55605					15.93	10.03	5.9				
G55773					15.84	10.03	5.81				
G51255					15.76	11.54	4.22				
G51806					15.74	11.339	4.41				
G55679					15.72	10.10	5.62				
G55849					15.71	9.86	5.85				
G55850					15.71	9.86	5.85				
G51871					15.7	11.77	3.93				
G51879					15.67	10.94	4.73				
G51286					15.65	10.84	4.81				
G55730					15.65	8.92	6.73				
G55770					15.65	8.92	6.73				
G51765					15.56	10.99	4.01				
G51766					15.56	10.99	4.01				
G55763					15.56	9.88	5.68				

\* Damping force, in pounds, to either extend or collapse the shock absorber at an average operating velocity. Fuerza de amortiguación en libras para extender o comprimir el amortiguador a una velocidad de operación promedio. La puissance d'amortissement en poids de l'amortisseur, soit comprimé, soit détendu, à une vitesse de fonctionnement moyenne.

## ESPECIFICACIONES POR TIPO DE MONTAJE

GRC	Montajes		Calibre de Pistón	Imagen de Diámetro Exterior	Longitudes [in]			Polvera	Tope Hidráulico	Fuerza*	
	Superior	Inferior			Extendido	Comprimido	Carrera			Rebote	Compresión
G51887					15.55	12.08	3.47				
G51888					15.55	12.08	3.47				
G55891					15.53	9.78	5.75				
G51730					15.42	10.11	5.31				
69573					15.41	10.4	5.01				
G55670					15.39	9.73	5.66				
G55671					15.39	9.73	5.66				
70159					15.35	10.44	4.91				
G51798					15.35	11.1	4.25				
G51858					15.35	11.18	4.17				
G55909					15.32	10.38	4.95				
G55802					15.31	10.37	4.94				
G55749					15.3	9.48	5.82				
42954					15.28	10.67	4.61				
G55774					15.24	10.55	4.7				
G55877					15.24	10.55	4.7				
G56518					15.23	8.83	6.41				
G55607					15.22	9.41	5.81				
G55608					15.22	9.41	5.81				
G51914					15.16	10.94	4.21				
G51196					14.93	9.95	4.98				
G51715					14.92	10.43	4.49				
G51830					14.92	10.55	4.37				
G55542					14.7	8.27	6.44				
G56757					14.7	9.34	5.36				
G51700					14.68	10.35	4.33				
G51716					14.68	10.35	4.33				
G56597					14.5	9.87	4.62				
14005					14.49	9.41	5.08				
G51803					14.41	10.12	4.29				
G55818					14.41	10.71	3.7				
G55743					14.35	8.36	5.99				
G55742					14.3	8.35	5.95				
G51267					14.25	10.70	3.55				
G51796					14.25	10.71	3.54				
42956					13.97	10.36	3.61				
G51852					13.89	10.66	3.23				
G55903					13.88	7.84	6.04				
G51728					13.87	9.62	4.25				
G55723					13.84	8.52	5.32				
G56786					13.37	8.50	4.87				
G56787					13.37	8.50	4.87				
69582					13.16	9.05	4.11				

\* Damping force, in pounds, to either extend or collapse the shock absorber at an average operating velocity. Fuerza de amortiguación en libras para extender o comprimir el amortiguador a una velocidad de operación promedio. La puissance d'amortissement en poids de l'amortisseur, soit comprimé, soit détendu, à une vitesse de fonctionnement moyenne.

## ESPECIFICACIONES POR TIPO DE MONTAJE

GRC	Montajes		Calibre de Pistón	Imagen de Diámetro Exterior	Longitudes [in]			Polvera	Tope Hidráulico	Fuerza*	
	Superior	Inferior			Extendido	Comprimido	Carrera			Rebote	Compresión
G56557					13.12	10.37	2.75				
42955					12.78	9.67	3.11				
70161					12.6	8.59	4.01				
G51227					12.00	7.13	4.87				
69581					11.77	8.61	3.16				

\* Damping force, in pounds, to either extend or collapse the shock absorber at an average operating velocity. Fuerza de amortiguación en libras para extender o comprimir el amortiguador a una velocidad de operación promedio. La puissance d'amortissement en poids de l'amortisseur, soit comprimé, doit détendu, à une vitesse de fonctionnement moyenne.

## ESPECIFICACIONES POR NÚMERO DE PARTE

GRC	Montajes		Calibre de Pistón	Imagen de Diámetro Exterior	Longitudes [in]			Polvera	Tope Hidráulico	Fuerza*	
	Superior	Inferior			Extendido	Comprimido	Carrera			Rebote	Compresión
14004					17.48	11.28	6.20				
14005					14.49	9.41	5.08				
14010	ES35	ES35			16.77	10.45	6.32				
14016	S1	S1			21.4	12.33	9.07				
14017	EB1	EB1			24.04	14.43	9.61				
14018	ES35	EB1			21.37	12.8	8.57				
14019	ES35	EB1			26.87	15.55	11.32				
14020	EB1	ES39			19.75	12.05	7.70				
14039	ES41	ES41			15.73	12.12	3.51				
14040	EB1	ES24			19.73	12.12	7.61				
14071	ES53	ES65			20.7	12.79	7.91				
14073					25.63	16.61	9.02				
34036	EB1	ES24			14.16	9.53	4.63				
34051	S1	BP30			13.28	8.67	4.61				
34052	S1	BP13			13.62	9	4.62				
34057	S12	ES41			15.01	10.14	4.87				
34058	S12	ES3			17.13	11.01	6.12				
34073	S1	BP7			14.29	9.37	4.92				
34076	S36	EB1			14.59	9.87	4.72				
42094					15.98	10.37	5.61				
42161					17.2	12.44	4.76				
42459					21.78	13.42	8.36				
42508					21.6	13.34	8.26				
42520					17.77	13.29	4.48				
42577					17.23	10.87	6.36				
42952					23	13.89	9.11				
42954					15.28	10.67	4.61				
42955					12.78	9.67	3.11				
42956					13.97	10.36	3.61				
43048	EB1	EB1			20.45	12.62	7.83				
43049	BP31	EB1			21.86	13.28	8.58				
43058	EB1	ES25			19.95	12.37	7.58				
43060	EB1	BP31			20.2	12.55	7.65				
43062	ES24	ES24			18.95	11.87	7.08				
43067	ES27	EB4			24.61	14.78	9.83				
43084	BP14	S1			21.42	12.84	8.58				
43085	EB4	ES27			20.61	12.78	7.83				
43093	ES24	ES24			20.2	12.62	7.58				
43096	ES27	EB4			22.61	13.78	8.83				
43099	S1	ES25			19.17	11.77	7.40				
43107	ES31	ES24			17.95	11.37	6.58				
43111	ES34	ES34			22.9	13.82	9.08				
43138	ES27	S12			18.18	11.1	7.08				

\* Damping force, in pounds, to either extend or collapse the shock absorber at an average operating velocity. Fuerza de amortiguación en libras para extender o comprimir el amortiguador a una velocidad de operación promedio. La puissance d'amortissement en poids de l'amortisseur, soit comprimé, soit détendu, à une vitesse de fonctionnement moyenne.

## ESPECIFICACIONES POR NÚMERO DE PARTE

GRC	Montajes		Calibre de Pistón	Imagen de Diámetro Exterior	Longitudes [in]			Polvera	Tope Hidráulico	Fuerza*	
	Superior	Inferior			Extendido	Comprimido	Carrera			Rebote	Compresión
43140	S1	EB1			20.92	12.84	8.08				
43142	ES185	ES185			21.45	13.12	8.33				
43143	S1	ES91			20.42	12.34	8.08				
43161	ES18	ES18			22.3	13.69	8.61				
43162	BP14	ES34			22.99	14.38	8.61				
43163	BP14	ES34			25.05	15.69	9.36				
43165	ES106	ES106			22.99	13.88	9.11				
43167	ES185	ES185			22.99	13.88	9.11				
43171	BP14	ES185			24.74	15.38	9.36				
43172	BP14	ES185			25.55	16.19	9.36				
43173	ES69	ES69			15.39	10.38	5.01				
43180	BP8	ES34			23.55	14.19	9.36				
43181	ES34	ES34			24.24	14.88	9.36				
44763					19.95	13.82					
44902					21.78	14.37					
49105	S1	S1			18.21	11.23	6.98				
49106	ES26	EB4			22.43	13.95	8.48				
49107	ES24	ES24			19.27	12.29	6.98				
49110	EB4	EB4			22.08	13.85	8.23				
49114	S1	EB1			20.24	12.51	7.73				
49122	S1	ES10			21.62	13.14	8.48				
49127	EB1	ES25			19.87	12.63	7.24				
49128	BP14	EB1			22.77	14.04	8.73				
49131	BP31	EB1			22.15	13.67	8.48				
49135	BP14	S1			21.62	13.14	8.48				
49149	ES27	EB4			24.93	15.64	9.29				
49151	EB1	EB1			20.35	12.83	7.52				
49152	BP31	EB1			20.27	13.04	7.23				
49155	EB1	ES34			23.27	14.29	8.98				
49157	BP14	EB1			21.37	13.29	8.08				
49162	ES24	ES24			20.02	12.79	7.23				
49173	S1	ES25			19.24	12.01	7.23				
49178	S1	ES25			23.12	13.89	9.23				
49193	BP14	ES10			21.27	13.29	7.98				
49196	S1	ES185			23.74	14.26	9.48				
49197	EB1	ES185			21.27	13.29	7.98				
49199	S1	ES91			20.68	12.7	7.98				
49203	S1	EB1			20.24	12.51	7.73				
49205	S1	EB1			21.12	13.13	7.99				
49207	EB1	ES106			22.81	14.06	8.75				
49212	ES27	ES27			21.02	13.29	7.73				
49213	BP14	ES34			24.27	14.79	9.48				
49214	EB1	ES41			23.27	14.29	8.98				

\* Damping force, in pounds, to either extend or collapse the shock absorber at an average operating velocity. Fuerza de amortiguación en libras para extender o comprimir el amortiguador a una velocidad de operación promedio. La puissance d'amortissement en poids de l'amortisseur, soit comprimé, doit détendu, à une vitesse de fonctionnement moyenne.



## ESPECIFICACIONES POR NÚMERO DE PARTE

GRC	Montajes		Calibre de Pistón	Imagen de Diámetro Exterior	Longitudes [in]			Polvera	Tope Hidráulico	Fuerza*	
	Superior	Inferior			Extendido	Comprimido	Carrera			Rebote	Compresión
49215	ES18	ES18			23.02	14.16	8.86				
49216	S12	BP7			20.74	12.76	7.98				
49217	EB1	ES185			25.27	15.29	9.98				
49218	BP14	ES34			26.34	16.36	9.98				
49221	ES141	ES25			18.36	11.88	6.48				
49222	EB1	ES25			18.77	12.04	6.73				
49223	EB1	ES41			23.27	14.29	8.98				
49225	BP14	ES185			25.77	15.54	10.23				
49226	BP20	EB1			20.77	13.04	7.73				
49228	S15	BP14			24.47	14.74	9.73				
49229	ES152	ES153			23.99	15.11	8.88				
49230	ES185	ES185			20.27	12.79	7.48				
49231	BP14	ES34			24.27	14.79	9.48				
49232	BP14	ES185			25.09	15.16	9.93				
49233	ES69	ES69			15.67	10.79	4.88				
49234	S1	ES185			19.77	13.98	5.79				
49235	ES34	ES34			24.77	15.04	9.73				
49236	ES18	ES18			17.77	11.54	6.23				
49237	S12	ES171			24.18	14.45	9.73				
49241	EB1	ES185			25.77	15.54	10.23				
49254	S69	ES15			17.86	12.45	5.41				
49255					24.54	14.66	9.87				
49304	ES10	EB1			14.35	9.75	4.60				
49307	ES17	ES17			16.35	10.75	5.60				
49309	EB1	S1			18.52	11.5	7.02				
49310	EB1	EB1			20.35	12.75	7.60				
49311	EB1	EB1			22.44	14	8.44				
49334	BP31	EB1			20.7	13.05	7.65				
49345	ES18	ES21			22.6	15.16	7.44				
49346	ES27	S12			18.08	11.48	6.60				
49369	ES84	ES84			21.86	13.51	8.35				
49370	S29	ES84			21.6	15.04	6.56				
49371	S29	ES53			22.55	13.7	8.85				
49387	S12	EB2			21.14	13.03	8.11				
49388	S12	EB2			21.79	13.39	8.40				
49613	S1	ES185			19.12	11.97	7.15				
49614	S29	ES24			19.04	11.94	7.10				
51006					21.01	13.25	7.76				
51022					24.76	16.75	8.01				
55514					16.98	10.4	6.58				
55526					17.4	10.83	6.58				
55657					17.22	10.93	6.3				
55658					17.22	10.93	6.3				

\* Damping force, in pounds, to either extend or collapse the shock absorber at an average operating velocity. Fuerza de amortiguación en libras para extender o comprimir el amortiguador a una velocidad de operación promedio. La puissance d'amortissement en poids de l'amortisseur, soit comprimé, soit détendu, à une vitesse de fonctionnement moyenne.

## ESPECIFICACIONES POR NÚMERO DE PARTE

GRC	Montajes		Calibre de Pistón	Imagen de Diámetro Exterior	Longitudes [in]			Polvera	Tope Hidráulico	Fuerza*	
	Superior	Inferior			Extendido	Comprimido	Carrera			Rebote	Compresión
55713					17.8	11.44	6.36				
55745					19.65	13.33	6.32				
55746					20.31	11.56	8.75				
55976					20.22	12.11	8.11				
55977					20.22	12.11	8.11				
55991					17.85	11.52	6.33				
56630					18.35	12.47	5.88				
56980					16.42	8.88	7.54				
58183	EB4	EB4			21.18	13.3	7.88				
58347	ES31	ES24			17.87	11.49	6.38				
58349	EB1	ES34			23.18	14.3	8.88				
58350	S1	ES25			18.6	11.65	6.95				
58353	ES27	EB4			24.52	14.9	9.62				
58355	EB11	ES24			14.87	10.11	4.76				
58357	ES24	ES24			14.68	10.06	4.62				
58359	S1	BP13			13.92	9.14	4.78				
58360	S1	BP13			15.42	9.89	5.53				
58366	ES34	ES34			23.18	14.3	8.88				
58377	EB1	ES25			19.87	12.49	7.38				
58386	S36	ES25			16.04	10.66	5.38				
58387	S1	ES25			23.15	14.03	9.12				
58389	ES27	ES27			29.02	17.15	11.87				
58394	ES24	EB1			15.68	10.56	5.12				
58403	ES26	ES26			24.48	14.95	9.53				
58406	EB1	ES185			22.87	13.99	8.88				
58409	EB1	ES185			21.37	13.24	8.13				
58410	S12	EB1			18.62	11.75	6.87				
58411	ES31	ES26			18.68	12.06	6.62				
58412	ES34	ES34			26.68	16.18	10.50				
58413	ES27	ES27			20.68	13.06	7.62				
58414	S36	ES41			15.04	10.16	4.88				
58416	S12	ES25			18.42	11.8	6.62				
58421	S1	BP30			13.42	8.89	4.53				
58422	BP14	ES34			23.87	14.49	9.38				
58423	ES26	ES26			16.45	10.67	5.78				
58437	ES31	ES24			22.99	14.09	8.90				
58438	EB1	ES34			29.68	17.55	12.13				
58455	ES41	ES41			22.87	13.99	8.88				
58456	ES25	ES25			26.68	16.06	10.62				
58461	ES185	ES185			25.37	15.24	10.13				
58488	BP14	ES34			26.68	16.05	10.63				
58489	S29	BP11			14.64	9.61	5.03				
58500	S36	ES185			15.04	10.16	4.88				

\* Damping force, in pounds, to either extend or collapse the shock absorber at an average operating velocity. Fuerza de amortiguación en libras para extender o comprimir el amortiguador a una velocidad de operación promedio. La puissance d'amortissement en poids de l'amortisseur, soit comprimé, soit détendu, à une vitesse de fonctionnement moyenne.

## ESPECIFICACIONES POR NÚMERO DE PARTE

GRC	Montajes		Calibre de Pistón	Imagen de Diámetro Exterior	Longitudes [in]			Polvera	Tope Hidráulico	Fuerza*	
	Superior	Inferior			Extendido	Comprimido	Carrera			Rebote	Compresión
58609	ES126	ES45			16.49	11.05	5.44				
58617	ES83	ES83			27.37	16.24	11.13				
58622	S36	EB1			15.04	10.16	4.88				
58623	S36	ES185			22.54	13.91	8.63				
58624	S36	ES185			20.04	12.66	7.38				
58625	EB1	EB20			22.36	13.83	8.53				
58638	BP14	ES34			23.87	14.49	9.38				
58661	S38	ES34			14.22	9.59	4.63				
58662	ES34	ES34			24.68	15.36	9.32				
58671	ES26	ES26			22.2	13.67	8.53				
58673	S38	ES34			22.72	13.84	8.88				
58674	S38	ES34			23.22	14.09	9.13				
58675	ES34	ES34			26.13	15.87	10.26				
58714	S62	BP7			15.26	9.98	5.28				
58715	S12	ES171			28.34	16.46	11.88				
58716	S62	ES26			15.74	10.37	5.37				
58717	ES25	ES25			22.87	13.99	8.88				
58778	S12	ES171			24.34	14.46	9.88				
58783	S12	BP11			14.59	10.21	4.38				
58803	S12	Horquilla			15.24	10.37	4.87				
58807	S36	EB1			15.24	10.11	5.13				
58808	ES41	ES41			28.38	16.75	11.63				
58809	EB1	ES185			23.65	14.53	9.12				
58810	EB1	ES185			31.42	18.42	13.00				
58811	EB1	ES185			25.36	15.23	10.13				
58812	ES86	EB20			22.45	14.07	8.38				
58817	S12	ES60			15.59	10.96	4.63				
58901	ES126	ES34			16.49	10.87	5.62				
58906	ES27	ES27			19.98	12.7	7.28				
58908	ES31	ES24			18.2	11.67	6.53				
58929	S36	EB1			14.54	9.76	4.78				
58930	ES34	ES34			22.81	14.06	8.75				
61500	EB1	EB1			20.23	12.37	7.86				
61501	S1	ES64			12.6	8.59	4.01				
61502	S8	S1			20.67	12.06	8.61				
61503	S29	ES84			21.12	16.31	4.81				
61504	S1	BP30			13.7	8.92	4.78				
61505	EB1	S1			18.95	11.67	7.28				
61506	EB1	EB1			21.86	13.58	8.28				
61507	S1	EB2			21.11	12.83	8.28				
61508	S1	ES64			14.11	9	5.11				
61509	S1	BP14			14.7	9.34	5.36				
61510	EB2	EB2			22.29	13.76	8.53				

\* Damping force, in pounds, to either extend or collapse the shock absorber at an average operating velocity. Fuerza de amortiguación en libras para extender o comprimir el amortiguador a una velocidad de operación promedio. La puissance d'amortissement en poids de l'amortisseur, soit comprimé, soit détendu, à une vitesse de fonctionnement moyenne.

## ESPECIFICACIONES POR NÚMERO DE PARTE

GRC	Montajes		Calibre de Pistón	Imagen de Diámetro Exterior	Longitudes [in]			Polvera	Tope Hidráulico	Fuerza*	
	Superior	Inferior			Extendido	Comprimido	Carrera			Rebote	Compresión
61511	BP13	ES27			23.16	14.13	9.03				
61512	S1	BP7			13.2	8.59	4.61				
61513	S8	EB1			19.95	12.42	7.53				
61516	ES31	ES24			18.23	11.37	6.86				
61517	ES24	ES24			14.98	9.95	5.03				
61518	S1	ES25			18.73	11.7	7.03				
61519	EB1	ES25			19.98	12.45	7.53				
61520	S36	ES41			15.34	10.31	5.03				
61521	S12	ES25			16.45	10.67	5.78				
61522	ES27	ES27			20.49	12.63	7.86				
61523	S1	BP13			13.7	8.92	4.78				
61524	EB1	ES34			23.26	14.23	9.03				
61525	EB1	ES24			15.01	9.95	5.06				
61526	ES27	EB4			24.64	14.86	9.78				
61528	BP14	ES34			23.98	14.45	9.53				
61529	S1	BP4			14.1	9.34	4.76				
61530	EB1	ES185			25.48	15.2	10.28				
61531	ES26	ES26			16.73	10.7	6.03				
61532	EB1	EB1			23.98	14.45	9.53				
61533	EB1	ES106			22.98	13.95	9.03				
61534	EB1	ES106			26.98	15.95	11.03				
61535	S1	BP7			20.45	12.67	7.78				
61536	BP20	EB1			19.98	12.45	7.53				
61538	ES18	ES18			17.98	11.45	6.53				
61539	ES141	ES141			22.79	14.01	8.78				
61540	S1	BP4			13.7	8.92	4.78				
61541	EB5	ES25			18.14	11.61	6.53				
61542	ES126	ES128			16.73	10.95	5.78				
61543	BP14	ES34			26.76	16.23	10.53				
61544	S29	BP11			14.54	9.75	4.79				
61545	S1	ES64			14.45	9.67	4.78				
61546	S1	ES64			18.45	11.67	6.78				
61547	ES185	ES185			23.01	14.07	8.94				
61549	S1	EB1			15.89	10.11	5.78				
61550	EB1	EB1			17.73	11.12	6.61				
61551	S1	ES25			22.45	13.42	9.03				
61552	S1	ES113			13.95	9.17	4.78				
61553	S36	ES25			15.09	10.06	5.03				
61554	ES185	ES185			21.48	13.2	8.28				
61555	S12	BP7			14.14	9.11	5.03				
61556	S1	BP7			14.2	9.09	5.11				
61557	ES141	ES25			18.42	11.88	6.54				
61558	S1	EB1			22.45	13.42	9.03				

\* Damping force, in pounds, to either extend or collapse the shock absorber at an average operating velocity. Fuerza de amortiguación en libras para extender o comprimir el amortiguador a una velocidad de operación promedio. La puissance d'amortissement en poids de l'amortisseur, soit comprimé, doit détendu, à une vitesse de fonctionnement moyenne.

## ESPECIFICACIONES POR NÚMERO DE PARTE

GRC	Montajes		Calibre de Pistón	Imagen de Diámetro Exterior	Longitudes [in]			Polvera	Tope Hidráulico	Fuerza*	
	Superior	Inferior			Extendido	Comprimido	Carrera			Rebote	Compresión
61559	EB1	ES185			22.98	13.95	9.03				
61560	S1	ES185			18.45	11.67	6.78				
61561	S36	EB1			15.09	10.06	5.03				
61565	BP14	ES34			24.26	14.73	9.53				
61568	EB1	ES142			19.64	12.36	7.28				
61569	S12	BP7			16.33	10.8	5.53				
61573	EB1	ES185			26.98	15.95	11.03				
61575	EB5	ES24			21.14	13.36	7.78				
61582	EB1	EB1			24.98	14.95	10.03				
61584	BP13	ES26			25.48	15.2	10.28				
61586	S1	EB1			22.95	13.67	9.28				
61588	S12	EB2			21.11	13.08	8.03				
61589	ES152	ES153			21.29	13.51	7.78				
61590	BP14	ES185			25.48	15.2	10.28				
61591	S36	EB1			14.47	9.71	4.76				
61592	S47	EB1			21.45	13.17	8.28				
61593	S1	ES64			14.95	9.67	5.28				
61594	EB1	S17			19.45	12.17	7.28				
61595	S36	ES185			20.07	12.54	7.53				
61596	S1	ES69			14.45	9.42	5.03				
61597	ES104	ES69			24.14	14.61	9.53				
61598	ES152	ES153			23.79	15.01	8.78				
61599	S38	ES34			13.8	9.52	4.28				
61600	ES34	ES34			24.51	14.98	9.53				
61601	S1	ES83			14.71	9.49	5.22				
61605	ES18	ES18			17.98	11.45	6.53				
61606	S1	BP19			14.7	9.34	5.36				
61607	S12	ES64			15.89	10.11	5.78				
61608	ES99	ES48			19.64	12.36	7.28				
61609	ES110	ES19			22.48	13.7	8.78				
61610	S1	ES153			19.04	11.76	7.28				
61611	S62	BP7			15.48	9.95	5.53				
61612	S12	ES171			28.39	16.36	12.03				
61613	S62	ES26			15.48	9.95	5.53				
61614	ES41	ES41			22.98	13.95	9.03				
61615	S12	BP11			20.3	12.27	8.03				
61616	BP20	ES24			19.39	12.23	7.16				
61623	S36	BP7			18.04	13.51	4.53				
61624	BP14	ES185			24.98	14.95	10.03				
61625	ES69	ES69			15.48	10.45	5.03				
61626	S36	BP10			13.73	9.45	4.28				
61627	ES185	ES185			22.98	13.95	9.03				
61629	ES185	ES185			26.98	15.95	11.03				

\* Damping force, in pounds, to either extend or collapse the shock absorber at an average operating velocity. Fuerza de amortiguación en libras para extender o comprimir el amortiguador a una velocidad de operación promedio. La puissance d'amortissement en poids de l'amortisseur, soit comprimé, soit détendu, à une vitesse de fonctionnement moyenne.

## ESPECIFICACIONES POR NÚMERO DE PARTE

GRC	Montajes		Calibre de Pistón	Imagen de Diámetro Exterior	Longitudes [in]			Polvera	Tope Hidráulico	Fuerza*	
	Superior	Inferior			Extendido	Comprimido	Carrera			Rebote	Compresión
61632	EB4	EB4			20.79	13.01	7.78				
61633	ES27	EB4			28.64	16.86	11.78				
61634	S38	ES34			22.3	13.77	8.53				
61635	S38	ES34			23.27	14.24	9.03				
61637	EB1	EB1			17.98	11.45	6.53				
61638	S12	ES171			24.45	14.42	10.03				
61641	S12	BP11			14.7	10.17	4.53				
61642	ES34	ES34			26.76	15.98	10.78				
61643	S12	Horquilla			15.36	10.33	5.03				
61646	S36	ES185			22.57	14.29	8.28				
61647	S1	ES25			23.23	13.95	9.28				
61649	ES34	ES34			23.26	14.23	9.03				
61650	S1	BP13			15.7	9.92	5.78				
61651	S47	EB1			24.4	14.64	9.76				
61654	ES185	ES185			28.76	16.98	11.78				
61655	ES185	ES185			23.01	14.07	8.94				
61656	ES185	ES185			31.51	18.48	13.03				
61657	ES185	ES185			25.48	15.2	10.28				
61658	ES26	ES26			24.48	14.7	9.78				
61659	ES185	ES185			20.76	12.98	7.78				
61662	S47	ES64			12.23	8.45	3.78				
61663	S12	ES60			15.7	10.92	4.78				
61664	S1	BP7			20.45	12.67	7.78				
61675	ES34	ES34			22.81	14.12	8.69				
61676	ES88	ES65			21.25	13.31	7.94				
61679	S1	ES25			14.71	9.49	5.22				
61680	S38	ES34			20.83	13.39	7.44				
61681	EB1	ES41			29.71	17.77	11.94				
61682	EB1	ES41			31.36	18.67	12.69				
61683	S11	Horquilla			15.07	10.44	4.63				
61684	S11	BP9			12.82	8.88	3.94				
61685	S11	BP9			14.12	9.68	4.44				
61686	BP14	ES34			22.36	13.92	8.44				
61687	BP14	ES34			23.87	14.68	9.19				
61688	BP14	ES34			25.19	15.31	9.88				
61690	EB20	EB20			24.78	15.84	8.94				
61691	ES34	ES34			26.51	16.12	10.39				
61692	ES34	ES34			26.05	15.87	10.18				
61696	BP18	ES26			22.45	14.5	7.95				
61697	BP18	ES26			22.62	14.43	8.19				
61699	EB2	EB2			19.41	12.65	6.76				
61700	EB2	EB2			20.37	13.11	7.26				
61703	ES83	ES83			20.15	13.96	6.19				

\* Damping force, in pounds, to either extend or collapse the shock absorber at an average operating velocity. Fuerza de amortiguación en libras para extender o comprimir el amortiguador a una velocidad de operación promedio. La puissance d'amortissement en poids de l'amortisseur, soit comprimé, soit détendu, à une vitesse de fonctionnement moyenne.

## ESPECIFICACIONES POR NÚMERO DE PARTE

GRC	Montajes		Calibre de Pistón	Imagen de Diámetro Exterior	Longitudes [in]			Polvera	Tope Hidráulico	Fuerza*	
	Superior	Inferior			Extendido	Comprimido	Carrera			Rebote	Compresión
61704	ES69	ES69			16.84	11.28	5.56				
61709	ES34	ES34			27.58	17.14	10.44				
61710	ES34	ES34			27.58	17.14	10.44				
61711	S36	ES26			21.8	13.61	8.19				
61712	S38	ES34			23.3	14.26	9.04				
61713	EB1	ES83			26.94	16	10.94				
61714	S62	ES77			23.36	14.22	9.14				
61715	ES88	ES69			24.12	15.18	8.94				
61716	ES34	ES34			26.5	16.33	10.17				
61717	ES47	ES26			22.75	14.56	8.19				
61718	ES128	ES45			21.33	13.64	7.69				
61720	ES17	ES19			15.92	11.23	4.69				
61777	ES164	ES68			15.62	10.68	4.94				
69407	S29	ES24			18.92	11.56	7.36				
69416	ES3	ES56			20.15	13.45	6.70				
69417	ES71	ES121			18.25	11.99	6.26				
69420	S1	EB3			22.81	14.68	8.13				
69450	S48	EB5			26.25	16	10.25				
69462	S50	ES80			24.11	15.01	9.10				
69464	384557-1	ES41			24.2	15.93	8.27				
69465	ES162	ES65			17.94	12.78	5.16				
69473	ES85	ES30			18.29	11.43	6.86				
69573					15.41	10.4	5.01				
69574	S36	ES7			20.26	12.5	7.76				
69575	S36	ES162			20.16	12.4	7.76				
69579					18.66	15.59	3.07				
69580					17.45	11.15	6.3				
69581					11.77	8.61	3.16				
69582					13.16	9.05	4.11				
69583					16.19	10.58	5.61				
69585	BP18	ES18			22.5	13.99	8.51				
69586	S20	ES89			23.5	15.62	7.88				
69587	ES19	ES56			15.9	10.64	5.26				
69589	ES19	ES59			17.54	11.53	6.01				
69590	S58	ES59			17.82	11.21	6.61				
69591	ES185	ES185			17.73	11.72	6.01				
69592	S1	ES107			20.07	12.56	7.51				
69593	S1	ES107			20.07	12.56	7.51				
69594	EB1	ES34			19.42	12.41	7.01				
69595	EB1	ES34			20.34	12.83	7.51				
69600	S1	BP30			13.61	8.75	4.86				
69604	BP31	EB1			20.64	12.78	7.86				
69606	S1	EB1			20.2	12.34	7.86				

\* Damping force, in pounds, to either extend or collapse the shock absorber at an average operating velocity. Fuerza de amortiguación en libras para extender o comprimir el amortiguador a una velocidad de operación promedio. La puissance d'amortissement en poids de l'amortisseur, soit comprimé, soit détendu, à une vitesse de fonctionnement moyenne.

## ESPECIFICACIONES POR NÚMERO DE PARTE

GRC	Montajes		Calibre de Pistón	Imagen de Diámetro Exterior	Longitudes [in]			Polvera	Tope Hidráulico	Fuerza*	
	Superior	Inferior			Extendido	Comprimido	Carrera			Rebote	Compresión
69616	ES18	ES19			16.63	10.87	5.76				
69622	ES10	EB1			14.73	9.62	5.11				
69624	BP14	S1			21.7	12.84	8.86				
69625	S1	BP19			14.11	9	5.11				
69632	ES84	ES84			21.78	13.42	8.36				
69633	S1	ES91			20.7	12.34	8.36				
69661	S36	ES137			20.1	15.04	5.06				
69670	S1	EB1			14.1	9.34	4.76				
69671	S1	ES133			18.1	11.34	6.76				
69674	S1	ES64			21.2	12.84	8.36				
69675	S1	BP7			14.61	9.25	5.36				
69676	S1	EB1			19.7	11.84	7.86				
69677	S1	ES8			18.45	11.34	7.11				
69689	ES85	ES85			15.63	10.37	5.26				
69703	ES27	S12			17.95	11.09	6.86				
69704	S1	S12			10.67	7.06	3.61				
69706	ES86	ES34			13.46	9.95	3.51				
69709	S1	ES185			23.7	13.84	9.86				
69713	S17	EB1			23.85	14.59	9.26				
69714	S1	BP17			14.1	9.94	4.16				
69715	ES18	ES110			13.98	9.37	4.61				
69723	S29	ES84			21.12	16.31	4.81				
69724	BP31	EB1			22.14	13.28	8.86				
69725	S1	ES69			21.6	13.09	8.51				
69726					17.7	13.54	4.16				
69727	BP14	ES53			13.13	9.12	4.01				
69733	BP27	ES137			17.88	12.72	5.16				
69749	S29	ES53			21.92	13.06	8.86				
69755	S1	ES185			20.45	12.34	8.11				
69756	S12	BP7			20.45	12.34	8.11				
69757	S1	ES85			24.6	17.54	7.06				
69760	ES18	ES79			16.26	12.6	3.66				
69766	S36	EB21			17.48	10.95	6.53				
69773	S33	ES69			22.44	17.38	5.06				
69782	ES67	ES61			15.1	10.34	4.76				
69787	ES27	ES19			17.79	11.53	6.26				
69794	S36	BP14			14.6	10.69	3.91				
69795	S12	ES110			15.2	9.59	5.61				
69805	ES71	ES71			18.19	11.93	6.26				
69807	S28	ES3			19.84	15.43	4.41				
69808	ES84	ES84			22.74	13.63	9.11				
69811	S36	BP14			13.6	9.69	3.91				
69813	S1	EB1			24.26	14.15	10.11				

\* Damping force, in pounds, to either extend or collapse the shock absorber at an average operating velocity. Fuerza de amortiguación en libras para extender o comprimir el amortiguador a una velocidad de operación promedio. La puissance d'amortissement en poids de l'amortisseur, soit comprimé, doit détendu, à une vitesse de fonctionnement moyenne.



## ESPECIFICACIONES POR NÚMERO DE PARTE

GRC	Montajes		Calibre de Pistón	Imagen de Diámetro Exterior	Longitudes [in]			Polvera	Tope Hidráulico	Fuerza*	
	Superior	Inferior			Extendido	Comprimido	Carrera			Rebote	Compresión
69820	S36	ES143			19.1	11.84	7.26				
69845	S36	ES143			19.2	13.94	5.26				
69858	ES18	ES18			21.23	12.87	8.36				
69861	S39	ES28			15.51	10.23	5.28				
69863	S27	ES18			24.43	14.91	9.52				
69877	S26	ES3			20.94	14.76	6.18				
69878	S30	ES3			20.94	14.76	6.18				
69880	S1	EB1			21.1	12.84	8.26				
69884	EB1	EB1			16.73	10.62	6.11				
69885	ES43	ES43			17.63	11.37	6.26				
69891	S12	ES10			21.61	13.1	8.51				
69898	S1	ES185			19.85	14.19	5.66				
69900	S1	ES67			24.91	14.8	10.11				
69901	S52	ES143			16.69	10.51	6.18				
69903	S27	ES18			21.69	12.99	8.70				
69907	S50	ES113			23.35	15.16	8.19				
69909	ES69	ES69			16.63	10.88	5.75				
69924					20.74	13.48	7.26				
69945	S19	ES84			26.35	16.45	9.90				
69946	S25	ES6			24.04	14.33	9.71				
69950	S30	ES3			18.62	17.62	1.00				
69951	S30	ES3			19.6	14.72	4.88				
69952	S33	ES3			21.45	18.38	3.07				
69956	S30	ES3			18.62	17.55	1.07				
69957	S30	ES3			18.22	16.18	2.04				
69962	S36	Horquilla			21.11	15.1	6.01				
69966	S33	ES3			17.62	11.27	6.35				
69995					22.57	13.91	8.66				
69996	S36	ES169			19.1	15.04	4.06				
69998	S67	ES92			17.91	14.09	3.82				
70000	S64	ES113			19.57	12.09	7.48				
70001	BP34	ES72			22.52	13.94	8.58				
70003	S34	ES147			26.55	18.62	7.93				
70005					17.28	11.57	5.71				
70010	BP15	ES69			22.56	14.09	8.47				
70013	S44	ES113			22.95	14.88	8.07				
70020	S60	ES53			21.89	13.14	8.75				
70023					21.81	15.94	5.87				
70024					23.39	19.48	3.9				
70027					17.82	12.95	4.88				
70028					25.39	16.42	8.98				
70031					21.89	14.41	7.48				
70032					26.18	15.31	10.87				

\* Damping force, in pounds, to either extend or collapse the shock absorber at an average operating velocity. Fuerza de amortiguación en libras para extender o comprimir el amortiguador a una velocidad de operación promedio. La puissance d'amortissement en poids de l'amortisseur, soit comprimé, soit détendu, à une vitesse de fonctionnement moyenne.

## ESPECIFICACIONES POR NÚMERO DE PARTE

GRC	Montajes		Calibre de Pistón	Imagen de Diámetro Exterior	Longitudes [in]			Polvera	Tope Hidráulico	Fuerza*	
	Superior	Inferior			Extendido	Comprimido	Carrera			Rebote	Compresión
70033					22.44	15.51	6.93				
70034					22.95	17.39	5.55				
70036					23.86	14.49	9.36				
70037					21.34	13.7	7.64				
70038					23.11	15.67	7.44				
70039					16.69	10.51	6.18				
70040					18.03	11.38	6.65				
70041					21.38	14.8	6.57				
70045					20.51	14.37	6.14				
70049					21.57	15.08	6.5				
70052					26.41	16.18	10.23				
70053					23.81	14.52	9.28				
70055					23.89	14.84	9.05				
70056					27.67	18.54	9.13				
70059					22.20	13.77	8.43				
70060					20.78	17.28	3.5				
70061					22.24	14.09	8.14				
70068					22.51	14.88	7.63				
70159					15.35	10.44	4.91				
70161					12.6	8.59	4.01				
70163					20.23	12.82	7.41				
75676	S1	EB1			19.66	11.83	7.83				
75755	S1	ES83			20.34	12.59	7.75				
75795	S12	ES110			15.24	9.66	5.58				
75811	S36	BP14			13.55	9.67	3.88				
75898	S12	ES83			19.85	14.18	5.67				
77183	EB1	EB1			20.86	13.01	7.85				
77349	EB1	ES34			23.32	14.29	9.03				
77355	EB1	ES24			14.85	9.86	4.99				
77357	ES24	ES24			14.85	9.86	4.99				
77359	S1	BP13			13.55	8.84	4.71				
77375	S12	BP7			14.14	9.04	5.10				
77377	EB1	ES25			19.87	12.23	7.64				
77389	EB1	ES27			28.73	16.92	11.81				
77403	ES26	ES26			24.31	14.78	9.53				
77405	EB1	EB1			19.87	12.23	7.64				
77406	EB1	ES83			22.92	13.9	9.02				
77409	EB1	ES83			21.54	13.11	8.43				
77410	S12	EB1			18.47	11.71	6.76				
77412	ES34	ES34			26.77	16.26	10.51				
77413	ES27	ES27			20.86	13.01	7.85				
77414	S36	ES83			15.33	10.34	4.99				
77418	S1	BP11			14.14	9.04	5.10				

\* Damping force, in pounds, to either extend or collapse the shock absorber at an average operating velocity. Fuerza de amortiguación en libras para extender o comprimir el amortiguador a una velocidad de operación promedio. La puissance d'amortissement en poids de l'amortisseur, soit comprimé, doit détendu, à une vitesse de fonctionnement moyenne.

## ESPECIFICACIONES POR NÚMERO DE PARTE

GRC	Montajes		Calibre de Pistón	Imagen de Diámetro Exterior	Longitudes [in]			Polvera	Tope Hidráulico	Fuerza*	
	Superior	Inferior			Extendido	Comprimido	Carrera			Rebote	Compresión
77421	S1	BP30			13.55	8.84	4.71				
77422	BP14	ES34			23.92	14.39	9.53				
77423	ES128	ES128			16.8	10.83	5.97				
77424	S1	BP7			20.34	12.59	7.75				
77425	EB1	BP20			19.87	12.23	7.64				
77454	ES141	ES141			22.77	14	8.77				
77455	ES83	ES83			22.92	13.9	9.02				
77456	EB1	ES83			26.73	15.94	10.79				
77461	EB1	ES83			25.39	15.18	10.21				
77479	S1	ES113			14.14	9.04	5.10				
77488	BP14	ES34			26.77	16.26	10.51				
77489	S29	BP11			14.36	9.55	4.81				
77492	EB1	EB1			22.33	13.6	8.73				
77494	EB2	EB2			21.78	13.52	8.26				
77524	EB1	ES83			26.87	15.87	11.00				
77525	EB1	ES83			22.9	14	8.90				
77607	BP14	ES83			25.39	15.18	10.21				
77608	S36	EB1			14.45	9.64	4.81				
77609	ES126	ES128			16.43	10.95	5.48				
77614	S36	EB1			15.04	10.05	4.99				
77623	S38	ES83			22.38	13.84	8.54				
77638	BP14	ES34			24.31	14.78	9.53				
77660	EB1	EB1			24.9	14.88	10.02				
77661	S12	ES34			13.72	9.5	4.22				
77662	ES34	ES34			24.31	14.78	9.53				
77673	S38	ES34			22.38	13.84	8.54				
77674	S38	ES34			23.27	14.27	9.00				
77675	ES34	ES34			26.25	15.74	10.51				
77678	S36	BP7			18.01	13.51	4.50				
77679	BP14	ES83			24.9	14.88	10.02				
77683	EB5	ES24			21.11	13.27	7.84				
77714	S38	BP7			15.34	9.84	5.50				
77715	S12	ES171			28.32	16.33	11.99				
77716	S38	ES26			15.32	9.84	5.48				
77717	ES25	ES25			22.92	13.9	9.02				
77726	S12	EB19			20.85	13.05	7.80				
77772	S36	BP10			14.51	9.72	4.79				
77778	S12	ES169			24.38	14.36	10.02				
77781	S1	ES113			18.57	11.8	6.77				
77782	S1	ES118			14.14	9.04	5.10				
77783	S12	BP11			14.64	10.12	4.52				
77803	S29	Horquilla			15.31	10.32	4.99				
77807	S36	EB1			15.33	10.34	4.99				

\* Damping force, in pounds, to either extend or collapse the shock absorber at an average operating velocity. Fuerza de amortiguación en libras para extender o comprimir el amortiguador a una velocidad de operación promedio. La puissance d'amortissement en poids de l'amortisseur, soit comprimé, doit détendu, à une vitesse de fonctionnement moyenne.

## ESPECIFICACIONES POR NÚMERO DE PARTE

GRC	Montajes		Calibre de Pistón	Imagen de Diámetro Exterior	Longitudes [in]			Polvera	Tope Hidráulico	Fuerza*	
	Superior	Inferior			Extendido	Comprimido	Carrera			Rebote	Compresión
77808	EB1	ES83			28.73	16.92	11.81				
77809	EB1	ES83			22.92	13.9	9.02				
77810	EB1	ES83			31.53	18.5	13.03				
77815	S47	ES64			21.97	13.2	8.77				
77817	S12	ES60			15.73	10.94	4.79				
77829	ES88	ES65			22.33	13.6	8.73				
77837	ES83	BP14			28.73	16.92	11.81				
77847	S1	BP7			20.34	12.59	7.75				
77902	S1	ES64			12.56	8.5	4.06				
77903	S1	BP14			14.64	9.33	5.31				
77904	S1	ES64			14.83	9.54	5.29				
77905	S1	ES83			14.64	9.33	5.31				
77907	EB1	EB1			19.87	12.23	7.64				
77909	S1	ES17			14.14	9.04	5.10				
77915	S1	BP7			13.61	8.85	4.76				
77937	S1	BP19			14.93	9.35	5.58				
77947	S38	ES34			15.63	10.88	4.75				
77948	S38	ES34			23.5	14.75	8.75				
77949	S38	BP27			16.16	10.67	5.49				
77950	ES34	ES34			27.5	17.5	10.00				
77951	S38	ES34			20.5	13	7.50				
77952	EB1	ES185			29.68	17.43	12.25				
77953	ES34	ES34			22.65	13.9	8.75				
77954	S29	BP13			13.83	9.08	4.75				
77955	S36	ES7			22.57	13.91	8.66				
77958	S1	ES25			14.51	9.35	5.16				
77967	S62	ES34			20.75	13.13	7.62				
77968	EB1	ES185			24.71	15.09	9.62				
77969	EB1	ES185			25.43	15.81	9.62				
77971					23.64	14.70	8.94				
77973					22.57	14.41	8.16				
81039	EB1	ES24			14.73	9.62	5.11				
81076	BP4	DS1			14.2	9.44	4.76				
81082	EB1	ES185			23.23	13.87	9.36				
81091	ES27	EB4			25.14	15.28	9.86				
81095	BP14	S1			21.7	12.84	8.86				
81096	S1	BP13			13.7	8.84	4.86				
81097	EB1	S1			18.2	11.09	7.11				
81108	ES24	ES24			14.23	9.37	4.86				
81113	ES31	ES24			18.23	11.37	6.86				
81147	EB1	EB1			20.23	12.37	7.86				
81153	S1	ES38			11.61	7.75	3.86				
81164	EB1	ES34			23.23	13.87	9.36				

\* Damping force, in pounds, to either extend or collapse the shock absorber at an average operating velocity. Fuerza de amortiguación en libras para extender o comprimir el amortiguador a una velocidad de operación promedio. La puissance d'amortissement en poids de l'amortisseur, soit comprimé, doit détendu, à une vitesse de fonctionnement moyenne.

## ESPECIFICACIONES POR NÚMERO DE PARTE

GRC	Montajes		Calibre de Pistón	Imagen de Diámetro Exterior	Longitudes [in]			Polvera	Tope Hidráulico	Fuerza*	
	Superior	Inferior			Extendido	Comprimido	Carrera			Rebote	Compresión
81174	ES34	ES34			23.23	13.87	9.36				
81242	S1	ES25			19.2	11.59	7.61				
81270	S1	S1			17.67	10.56	7.11				
81285	S1	ES25			23.2	13.84	9.36				
81318	EB1	EB1			22.73	13.87	8.86				
81322	S1	ES67			15.51	10	5.51				
81338	ES27	S12			17.95	11.09	6.86				
81340	S1	EB1			20.7	12.34	8.36				
81342	ES27	EB4			28.89	16.78	12.11				
81394	S36	ES25			17.47	11.21	6.26				
81406	S1	S12			10.67	7.06	3.61				
81416	S9	EB1			18.6	11.59	7.01				
81438	BP14	ES10			20.23	12.37	7.86				
81440	S17	EB1			24.6	14.59	10.01				
81445	ES86	ES34			13.46	9.95	3.51				
81446	S1	BP7			14.61	9.25	5.36				
81450	BP27	ES137			17.88	12.72	5.16				
81459	ES84	ES84			21.73	13.37	8.36				
81460	S1	ES91			20.7	12.34	8.36				
81461	S1	ES185			23.7	13.84	9.86				
81464	ES85	ES64			15.63	10.37	5.26				
81469	EB4	EB4			22.54	13.68	8.86				
81478	S1	ES64			12.6	8.59	4.01				
81481	S1	EB1			19.7	11.84	7.86				
81482	BP14	ES34			24.23	14.37	9.86				
81484	EB1	ES25			20.23	12.37	7.86				
81490	S12	ES41			14.85	9.84	5.01				
81491	S12	DS1			13	8.74	4.26				
81492	BP31	EB1			20.64	12.78	7.86				
81494	S1	BP30			13.61	8.75	4.86				
81495	S1	EB1			20.2	12.34	7.86				
81496	ES27	ES27			20.49	12.63	7.86				
81498	S17	EB1			22.1	13.34	8.76				
81501	S1	ES64			21.6	14.44	7.16				
81507	S1	ES64			14.26	9.15	5.11				
81508	S12	ES64			21.6	13.34	8.26				
81510	EB1	ES185			25.73	15.12	10.61				
81514	BP31	EB1			22.14	13.28	8.86				
81516	ES26	ES26			16.73	10.62	6.11				
81517	S29	ES84			21.12	16.31	4.81				
81529	ES18	ES18			17.73	11.12	6.61				
81530	S29	ES53			21.92	13.06	8.86				
81538	EB1	EB1			24.23	14.37	9.86				

\* Damping force, in pounds, to either extend or collapse the shock absorber at an average operating velocity. Fuerza de amortiguación en libras para extender o comprimir el amortiguador a una velocidad de operación promedio. La puissance d'amortissement en poids de l'amortisseur, soit comprimé, soit détendu, à une vitesse de fonctionnement moyenne.

## ESPECIFICACIONES POR NÚMERO DE PARTE

GRC	Montajes		Calibre de Pistón	Imagen de Diámetro Exterior	Longitudes [in]			Polvera	Tope Hidráulico	Fuerza*	
	Superior	Inferior			Extendido	Comprimido	Carrera			Rebote	Compresión
81539	EB1	ES106			23.23	13.87	9.36				
81540	EB1	ES106			25.73	15.12	10.61				
81541	S1	BP14			14.7	9.34	5.36				
81542	S8	EB1			20.1	12.34	7.76				
81548	S1	BP7			20.6	12.59	8.01				
81549	BP20	EB1			20.73	12.62	8.11				
81553	S1	ES64			15.2	9.59	5.61				
81554	ES64	EB1			18.48	11.62	6.86				
81555	ES44	ES1			16.13	10.62	5.51				
81557	ES64	ES112			16.29	10.93	5.36				
81558	S1	ES109			19.01	12.35	6.66				
81559	S1	BP7			13.2	8.59	4.61				
81560	BP13	ES27			23.14	13.78	9.36				
81562	S36	ES74			19.85	15.54	4.31				
81581	ES141	ES141			22.54	13.68	8.86				
81582	S1	BP4			13.45	8.84	4.61				
81583	EB5	ES25			18.39	11.53	6.86				
81667	BP14	ES34			26.95	16.19	10.76				
81668	S29	BP11			14.32	9.56	4.76				
81670	S1	BP7			11.7	7.84	3.86				
81671	S1	ES85			23.35	15.44	7.91				
81674	S1	ES185			20.45	12.34	8.11				
81675	S1	EB1			15.7	9.84	5.86				
81676	EB1	EB1			17.73	11.12	6.61				
81691	S1	ES25			24.2	14.09	10.11				
81693	S12	BP7			20.45	12.34	8.11				
81694	S36	ES25			14.72	9.71	5.01				
81710	EB1	ES185			21.73	13.12	8.61				
81713	S29	BP7			14.42	9.31	5.11				
81714	S1	BP7			14.2	9.09	5.11				
81726	ES126	ES128			16.48	10.87	5.61				
81727	ES141	ES25			18.44	11.58	6.86				
81730	EB1	ES185			23.23	13.87	9.36				
81739	ES85	ES64			16.23	10.87	5.36				
81741	ES69	ES4			18.31	13.64	4.67				
81742	S36	ES53			22.6	13.59	9.01				
81744	S36	EB1			14.52	9.76	4.76				
81750	S1	BP30			13.61	8.75	4.86				
81789	BP14	ES34			23.73	14.12	9.61				
81790	S29	ES24			18.92	11.56	7.36				
81791	S12	ES110			15.2	9.59	5.61				
81792	S36	BP14			13.6	9.69	3.91				
81793	ES84	ES84			22.78	13.67	9.11				

\* Damping force, in pounds, to either extend or collapse the shock absorber at an average operating velocity. Fuerza de amortiguación en libras para extender o comprimir el amortiguador a una velocidad de operación promedio. La puissance d'amortissement en poids de l'amortisseur, soit comprimé, soit détendu, à une vitesse de fonctionnement moyenne.

## ESPECIFICACIONES POR NÚMERO DE PARTE

GRC	Montajes		Calibre de Pistón	Imagen de Diámetro Exterior	Longitudes [in]			Polvera	Tope Hidráulico	Fuerza*	
	Superior	Inferior			Extendido	Comprimido	Carrera			Rebote	Compresión
81794	S1	ES185			19.85	14.19	5.66				
81795	S1	ES143			19.2	13.94	5.26				
81821	ES41	ES41			23.23	13.87	9.36				
81823	BP14	ES185			25.73	15.12	10.61				
81825	EB4	EB4			21.1	12.99	8.11				
81826	S12	BP7			15.6	10.09	5.51				
81828	S36	ES185			22.72	14.21	8.51				
81833	S36	ES185			20.21	12.45	7.76				
81834	S1	BP13			15.7	9.84	5.86				
81836	S1	ES83			14.75	9.39	5.36				
81837	BP13	ES27			26.28	15.42	10.86				
81869	S1	BP7			20.6	12.59	8.01				
81870	S1	ES113			13.86	9	4.86				
81871	EB2	EB2			22.04	13.43	8.61				
81872	S1	ES64			14.95	9.59	5.36				
81873	ES34	ES34			24.74	14.88	9.86				
81878	ES18	ES18			17.73	11.12	6.61				
81880	ES10	EB1			14.73	9.62	5.11				
81881	S36	ES143			19.1	11.84	7.26				
81882	ES69	ES69			15.63	10.37	5.26				
81890	BP14	ES185			25.28	14.92	10.36				
81891	EB5	ES24			21.09	13.33	7.76				
81892	S12	ES171			24.2	14.09	10.11				
81893	S36	BP7			18.27	13.51	4.76				
81902	S1	ES76			14.75	9.39	5.36				
81904	S1	ES185			18.46	11.7	6.76				
81905	EB1	ES185			26.97	15.86	11.11				
81906	S12	EB19			21.11	13.1	8.01				
81907	EB19	ES69			24.14	14.53	9.61				
81908	S1	BP19			14.75	9.34	5.41				
81909	EB19	ES48			19.63	12.27	7.36				
81910	ES19	ES110			22.48	13.62	8.86				
81911	S1	ES153			19.04	11.68	7.36				
81912	S62	BP7			15.48	9.87	5.61				
81913	S12	ES171			28.39	16.28	12.11				
81914	S62	ES26			15.48	9.87	5.61				
81916	S36	BP10			13.72	9.46	4.26				
81917	EB1	ES185			23.03	13.92	9.11				
81918	EB1	ES185			26.97	15.86	11.11				
81919	S38	ES34			22.3	13.54	8.76				
81920	S12	BP11			14.71	10.1	4.61				
81921	ES34	ES34			26.76	15.67	11.09				
81922	S12	Horquilla			15.35	10.24	5.11				

\* Damping force, in pounds, to either extend or collapse the shock absorber at an average operating velocity. Fuerza de amortiguación en libras para extender o comprimir el amortiguador a una velocidad de operación promedio. La puissance d'amortissement en poids de l'amortisseur, soit comprimé, doit détendu, à une vitesse de fonctionnement moyenne.

## ESPECIFICACIONES POR NÚMERO DE PARTE

GRC	Montajes		Calibre de Pistón	Imagen de Diámetro Exterior	Longitudes [in]			Polvera	Tope Hidráulico	Fuerza*	
	Superior	Inferior			Extendido	Comprimido	Carrera			Rebote	Compresión
81923	ES26	ES26			24.47	14.61	9.86				
81924	ES185	ES185			20.78	12.67	8.11				
81925	S12	ES7			14.7	9.59	5.11				
81926	ES88	ES65			21.25	13.24	8.01				
81927	S36				21.01	15.87	5.14				
81928	S38	ES34			13.78	9.52	4.26				
81929	BP20	ES24			19.49	12.13	7.36				
81930	ES34	ES34			22.81	13.95	8.86				
81931	ES34	ES34			26.53	16.02	10.51				
81932	S38	ES34			15.87	10.51	5.36				
81933	S29	BP13			13.97	9.11	4.86				
81934	S20	ES84			26.14	16.45	9.69				
81935	S70	ES41			24.19	15.93	8.26				
81936	S12	BP11			20.3	12.19	8.11				
81937	S47	EB1			21.44	13.18	8.26				
82001	ES64	ES64			15.98	10.37	5.61				
82002	S17	ES14			16.2	10.09	6.11				
82003	ES24	ES24			18.55	11.44	7.11				
82004	S17	S1			14.17	8.81	5.36				
82005	S1	ES64			17.2	12.44	4.76				
82006	ES24	ES24			20.48	12.62	7.86				
82007	EB1	EB1			18.23	11.37	6.86				
82010	ES34	ES34			16.63	12.47	4.16				
82011	S1	ES11			12.11	8	4.11				
82012	BP6	ES25			16.04	10.53	5.51				
82013	S29	BP20			20.82	13.06	7.76				
82020	S8	ES62			18.11	11	7.11				
82025	S36	BP17			12.95	9.19	3.76				
82026	S1	S1			13.42	8.56	4.86				
82030	ES43	ES43			20.23	12.37	7.86				
82031	ES18	ES18			16.23	10.37	5.86				
82032	ES64	ES64			22.73	13.87	8.86				
82033	ES25	EB19			18.79	12.03	6.76				
82034	S1	S1			22.17	12.81	9.36				
82035	ES24	EB1			14.64	9.53	5.11				
82038	S1	S1			24.67	14.06	10.61				
82039	S1	EB1			17.7	10.84	6.86				
82040	S1	ES10			21.7	12.84	8.86				
82046	EB4	EB4			26.04	15.43	10.61				
82047	EB1	EB1			20.23	12.37	7.86				
82049	S1	S1			13.17	8.31	4.86				
82051	BP8	EB1			22.14	13.28	8.86				
82054	EB4	EB4			24.54	14.68	9.86				

\* Damping force, in pounds, to either extend or collapse the shock absorber at an average operating velocity. Fuerza de amortiguación en libras para extender o comprimir el amortiguador a una velocidad de operación promedio. La puissance d'amortissement en poids de l'amortisseur, soit comprimé, doit détendu, à une vitesse de fonctionnement moyenne.



## ESPECIFICACIONES POR NÚMERO DE PARTE

GRC	Montajes		Calibre de Pistón	Imagen de Diámetro Exterior	Longitudes [in]			Polvera	Tope Hidráulico	Fuerza*	
	Superior	Inferior			Extendido	Comprimido	Carrera			Rebote	Compresión
82060	EB1	EB1			23.23	13.87	9.36				
82062	ES24	ES24			24.23	14.37	9.86				
82065	EB4	EB4			19.04	11.93	7.11				
82066	S1	EB1			22.7	13.34	9.36				
82067	S1	EB4			20.86	12.5	8.36				
82069	S1	S1			14.59	9.31	5.28				
82070	S1	DS1			15.75	9.99	5.76				
82072	S1	ES8			11.61	7.75	3.86				
82074	S1	ES24			18.7	11.34	7.36				
82075	S1	BP10			16.1	10.34	5.76				
82076	ES66	S1			18.7	11.34	7.36				
82079	ES9	BP20			15.54	9.93	5.61				
82086	ES35	ES35			25.54	14.93	10.61				
82087	S1	BP20			14.61	9.25	5.36				
82089	ES12	EB1			22.23	13.37	8.86				
82090	S1	ES8			16.11	10	6.11				
82093	BP31	ES10			21.23	12.87	8.36				
82099	S1	BP19			14.11	9	5.11				
82103	ES145	S1			22.7	13.34	9.36				
82104	BP19	DS1			14.2	9.44	4.76				
82109	S1	ES32			13.64	8.74	4.90				
82110	S1	BP8			14.1	8.99	5.11				
82118	S5	BP19			15.31	10.06	5.25				
82123	S9	EB1			18.6	11.59	7.01				
82124	S17	EB1			22.1	13.34	8.76				
82125	S8	S1			20.67	12.06	8.61				
82126	S36	DS1			14.25	9.24	5.01				
82128	S36	ES40			11.2	8.19	3.01				
82129	S1	BP3			12.51	8.5	4.01				
82130	EB1	S36			17.7	10.84	6.86				
82131	ES27	EB4			22.39	13.53	8.86				
82138	S1	BP3			15.1	9.49	5.61				
82139	EB1	EB1			12.98	9.97	3.01				
82147	EB1	ES25			23.23	13.87	9.36				
82151	ES145	ES70			23.23	13.87	9.36				
82155	S1	EB1			20.7	12.34	8.36				
82156	EB1	EB1			20.23	12.37	7.86				
82601	S1	ES16			13.61	8.75	4.86				
82602	BP8	EB1			23.23	13.87	9.36				
82603	S1	EB1			17.7	10.84	6.86				
82607	EB1	EB1			14.73	9.62	5.11				
82608	S12	ES39			20.85	13.94	6.91				
82609	EB1	ES35			25.64	15.03	10.61				

\* Damping force, in pounds, to either extend or collapse the shock absorber at an average operating velocity. Fuerza de amortiguación en libras para extender o comprimir el amortiguador a una velocidad de operación promedio. La puissance d'amortissement en poids de l'amortisseur, soit comprimé, soit détendu, à une vitesse de fonctionnement moyenne.

## ESPECIFICACIONES POR NÚMERO DE PARTE

GRC	Montajes		Calibre de Pistón	Imagen de Diámetro Exterior	Longitudes [in]			Polvera	Tope Hidráulico	Fuerza*	
	Superior	Inferior			Extendido	Comprimido	Carrera			Rebote	Compresión
82610	EB1	EB1			23.23	13.87	9.36				
82614	S12	ES5			12.01	8.25	3.76				
82615	EB4	BP11			15.69	10.43	5.26				
82617	S1	EB4			18.86	11.5	7.36				
82618	BP14	EB1			25.73	15.12	10.61				
83001	ES149	EB1	1-3/8"	A	10.41†	8.36†	3	SÍ	SÍ	793	363
83002	ES10	ES10	1-3/8"	A	11.61	8.62	3	SÍ	SÍ	3112	590
83003	S1	BP7	1-3/8"	A	11.76	8.95†	3.4	SÍ	SÍ	248	100
83004	ES35	ES136	1"	2" D/T	9.36†	7.29	2.32	SÍ	SÍ	539	324
83005	BP8	S10	1-3/16"	2" D/T	7.34	5.87	1.47	SÍ	NO	858	216
83006	ES149	EB1	1-3/8"	A	10.66	8.48†	2.77	SÍ	SÍ	525	182
83007	EB1	EB1	1-3/8"	A	18.54	11.67	6.87	NO	NO	489	343
83008	ES136	ES136	1-3/8"	A	12.98†	10.15†	3.99	SÍ	SÍ	699	307
83009	ES149	ES149	1-3/8"	A	10.41†	8.36†	2.99	SÍ	SÍ	793	363
83010	ES24	ES24	1"	2" D/T	14.15†	9.33	5.07	SÍ	SÍ	188	70
83011	EB1	EB1	1-3/8"	A	11.55†	8.43	3.62	SÍ	SÍ	738	330
83012	EB1	EB1	1-3/8"	A	11.05†	8.18	3.37	SÍ	SÍ	738	330
83013	BP8	BP8	1-3/16"	2" D/T	7.66	6.63†	1.7	SÍ	NO	646	480
83014	S1	S1	1-3/8"	A	10.48	7.11	3.37	NO	NO	544	501
83015	BP8	S1	1-3/8"	A	9.79	7.55	2.24	SÍ	SÍ	735	430
83016	ES10	ES10	1"	1-5/8"	11.51	8.14	3.37	NO	SÍ	506	139
83017	ES149	ES149	1-3/8"	A	10.93	8.35†	3.13	SÍ	SÍ	353	138
83018	ES24	S10	1-3/8"	A	10.3†	8.42†	3.24	SÍ	SÍ	515	174
83019	ES24	S10	1-3/8"	A	9.42	8.16†	2.28	SÍ	SÍ	509	121
83020	ES91	ES91	1-3/8"	A	9.41	7.17	2.24	SÍ	SÍ	796	255
83021	ES10	ES10	1-3/8"	A	9.36	7.37	1.99	SÍ	SÍ	745	315
83022	ES24	ES24	1"	2" D/T	14.28	9.33	4.95	SÍ	NO	840	152
83023	ES10	ES181	1"	1-5/8"	8.7	7.09†	2.14	NO	SÍ	484	157
83024	ES10	ES10	1-3/8"	2-1/2" D/T	11.61	8.62	2.99	SÍ	SÍ	811	320
83025	ES163	ES163	1-3/8"	A	7.98	6.49	1.49	SÍ	SÍ	710	230
83026	ES24	ES24	1-3/8"	A	13.11	9.12	3.99	SÍ	SÍ	602	104
83027	ES24	S10	1-3/8"	A	13.8	9.18	4.62	SÍ	SÍ	602	104
83028	ES86	ES167	1-3/8"	A	9.94	7.57	2.37	SÍ	SÍ	445	531
83029	ES168	ES169	1-5/8"	C	10.35	7.94	2.41	SÍ	NO	1303	1349
83030	ES136	ES136	1-3/8"	A	9.6†	7.61	2.49	SÍ	SÍ	308	87
83031	ES10	ES10	1-3/8"	2-1/2" D/T	11.49	8.62	2.87	SÍ	SÍ	811	314
83032	ES163	ES163	1-3/8"	A	7.85	6.36	1.49	NO	SÍ	779	135
83033	ES53	ES53	1-3/8"	A	13.99	10.37	3.62	SÍ	SÍ	494	312
83034	ES115	ES115	1-3/16"	1-5/8"	10.04†	7.32	2.97	NO	SÍ	430	129
83035	ES166	ES136	1-3/8"	A	12.96†	9.33	4.13	SÍ	SÍ	320	100
83038	ES149	EB1	1-3/8"	A	10.41†	8.36†	2.99	SÍ	SÍ	336	242
83039	ES149	ES149	1-3/8"	A	10.41†	8.36†	2.99	SÍ	SÍ	876	326
83040	ES171	ES172	1-3/8"	A	10.41†	8.36†	2.99	SÍ	SÍ	876	326

\* Damping force, in pounds, to either extend or collapse the shock absorber at an average operating velocity. Fuerza de amortiguación en libras para extender o comprimir el amortiguador a una velocidad de operación promedio. La puissance d'amortissement en poids de l'amortisseur, soit comprimé, doit détendu, à une vitesse de fonctionnement moyenne.

† At bumper contact / Al contacto con el tope de goma / Au contact avec le butoir

## ESPECIFICACIONES POR NÚMERO DE PARTE

GRC	Montajes		Calibre de Pistón	Imagen de Diámetro Exterior	Longitudes [in]			Polvera	Tope Hidráulico	Fuerza*	
	Superior	Inferior			Extendido	Comprimido	Carrera			Rebote	Compresión
83041	BP27	S10	1-3/8"	A	10.51†	8.34†	3.02	SÍ	SÍ	486	189
83042	ES136	ES136	1-3/8"	A	9.88†	8.44†	2.38	SÍ	SÍ	954	541
83043	ES17	ES17	1-3/16"	2" D/T	8.51	6.51	2	SÍ	NO	223	157
83044	ES27	ES164	1-3/8"	A	10.91	7.93	2.98	SÍ	SÍ	789	296
83045	ES19	S10	1-3/8"	A	11.53†	8.58†	3.81	SÍ	NO	510	153
83046	ES10	ES181	1-3/16"		9.23†	7.62†	2.73	NO	SÍ	514	173
83047	ES149	EB1	1-3/8"	A	11.78†	9.74†	3	SÍ	SÍ	364	314
83048	ES86	ES167	1-3/8"	A	9.97	8.43†	2.37	SÍ	SÍ	904	415
83049	ES163	ES163	1-3/8"	A	8.02	6.53	1.48	SÍ	SÍ	2879	705
83050	ES19	S10	1-3/8"	A	10.43†	8.38†	2.9	SÍ	SÍ	599	321
83051	ES10	ES10	1-3/8"	2-1/2" D/T	9.41	7.4	2.01	SÍ	SÍ	579	163
83052	ES185	ES185	1-3/8"	2-1/2" D/T	9.41	7.19	2.23	SÍ	NO	1101	149
83053	ES185	ES185	1-3/8"	A	10.91	7.93	2.97	SÍ	SÍ	968	214
83054	ES185	ES185	1-3/8"	A	10.28	7.56	2.72	SÍ	SÍ	1004	184
83056	ES136	ES136	1-5/8"	C	11.53	8.63	2.89	SÍ	SÍ	3830	737
83057	ES171	ES172	1-3/8"	2-1/2" D/T	10.44†	8.4†	2.99	SÍ	SÍ	364	242
83058	ES19	S10	1-3/8"	A	10.43†	8.38†	2.9	SÍ	SÍ	742	243
83059	ES35	ES35	1-3/8"	A	12.06†	8.68	3.88	SÍ	SÍ	738	350
83060	EB	BP7	1-3/8"	A	9.76	7.98†	2.25	NO	SÍ	431	441
83061	ES10	ES10	1-3/8"	2-1/2" D/T	9.41	7.4	2.01	SÍ	SÍ	1030	220
83062	ES185	S42	1-3/8"	A	12.71	9.18	3.53	SÍ	NO	704	153
83063	ES175	ES136	1-3/8"	A	10.76†	9.26†	3.01	SÍ	SÍ	954	541
83064	ES149	ES149	1-3/8"	A	10.41†	8.36†	2.99	SÍ	SÍ	635	323
83065	ES	ES171	1-5/8"	G	12.52	9.32	3.2	SÍ	SÍ	680	184
83066	ES153	ES153	1-3/8"	A	11.15†	9.2†	2.78	SÍ	SÍ	599	221
83100	ES90	ES90	1-3/8"	A	26.6	16.11	10.49	SÍ	SÍ	481	142
83101	ES90	ES90	1-3/8"	A	24.6	15.11	9.49	SÍ	SÍ	481	142
83102	S21	S21	1-3/8"	A	22.94	13.56	9.38	SÍ	SÍ	513	333
83103	S21	S21	1-3/8"	A	19.64	11.89	7.75	SÍ	SÍ	517	301
83104	EB3	EB3	1-3/8"	A	28.24	17.12	11.12	SÍ	NO	698	133
83105	S40	ES179	1-3/8"	A	31.91	18.29	13.62	SÍ	NO	559	150
83106	S21	S21	1-3/8"	A	29.25	16.76	12.49	SÍ	NO	451	80
83107	EB2	EB2	1-3/8"	A	31.6	18.36	13.24	SÍ	NO	352	77
83109	ES36	S42	1-3/8"	A	26.14	15.9	10.24	SÍ	SÍ	345	78
83110	ES36	S42	1-3/8"	A	22.89	14.27	8.62	SÍ	SÍ	450	143
83111	ES36	S42	1-3/8"	A	26.14	15.9	10.24	SÍ	SÍ	560	141
83112	ES36	S42	1-3/8"	A	21.52	13.4	8.12	SÍ	SÍ	1064	343
83113	ES36	EB3	1-3/8"	A	20.42	13.43	6.99	SÍ	SÍ	997	238
83114	S40	ES35	1-3/8"	A	23	13.76	9.24	SÍ	NO	450	102
83115	ES36	EB3	1-3/8"	A	16.19	13.32	4.87	SÍ	SÍ	997	238
83116	ES164	ES165	1-3/8"	A	23.81	14.68	9.12	SÍ	NO	354	300
83117	EB4	EB1	1-3/8"	A	23.94	14.45	9.49	SÍ	NO	354	300
83118	ES164	ES90	1-3/8"	A	24.45	14.71	9.74	SÍ	NO	410	311

\* Damping force, in pounds, to either extend or collapse the shock absorber at an average operating velocity. Fuerza de amortiguación en libras para extender o comprimir el amortiguador a una velocidad de operación promedio. La puissance d'amortissement en poids de l'amortisseur, soit comprimé, doit détendu, à une vitesse de fonctionnement moyenne.

† At bumper contact / Al contacto con el tope de goma / Au contact avec le butoir

## ESPECIFICACIONES POR NÚMERO DE PARTE

GRC	Montajes		Calibre de Pistón	Imagen de Diámetro Exterior	Longitudes [in]			Polvera	Tope Hidráulico	Fuerza*	
	Superior	Inferior			Extendido	Comprimido	Carrera			Rebote	Compresión
83119	EB4	ES165	1-3/8"	A	23.96	14.84	9.12	SÍ	NO	354	300
83120	ES120	S21	1-3/8"	A	22.12	13.63	8.49	SÍ	SÍ	779	164
83121	ES36	ES36	1-3/8"	A	30.25	18.32	11.93	SÍ	SÍ	689	126
83122	ES36	ES36	1-3/8"	A	25.24	15.75	9.49	SÍ	SÍ	661	201
83123	ES36	ES36	1-3/8"	A	26.62	16.38	10.24	SÍ	SÍ	589	119
83124	ES36	ES36	1-3/8"	A	21.65	13.75	7.87	SÍ	SÍ	750	137
83125	ES36	ES36	1-3/8"	A	28.12	17.13	10.99	SÍ	SÍ	625	115
83126	ES36	ES36	1-3/8"	A	24.37	15.25	9.12	SÍ	SÍ	625	115
83127	ES36	ES36	1-3/8"	A	20.12	13.13	6.99	SÍ	SÍ	940	218
83128	ES36	ES36	1-3/8"	A	16.87	11.51	5.37	SÍ	SÍ	940	218
83130	ES36	ES36	1-3/8"	A	18.03	12.04	5.99	SÍ	SÍ	871	177
83131	ES83	ES83	1-3/8"	A	27.8	18.18	9.62	SÍ	NO	212	129
83132	EB3	EB3	1-3/8"	A	25.24	15.5	9.74	SÍ	NO	828	150
83134	S21	ES36	1-3/8"	A	22.24	13.5	8.74	SÍ	NO	430	49
83135	ES90	ES90	1-3/8"	A	19.48	12.36	7.12	SÍ	NO	519	121
83136	S21	S21	1-3/8"	A	29.25	16.76	12.49	SÍ	NO	914	65
83137	ES36	ES36	1-3/8"	A	30.03	17.78	12.25	SÍ	SÍ	517	132
83138	ES36	S42	1-3/8"	A	23.55	14.42	9.12	SÍ	SÍ	997	231
83140	EB3	EB3	1-3/8"	A	25.27	15.52	9.75	SÍ	NO	738	88
83141	EB3	EB3	1-3/8"	A	25.27	15.52	9.75	SÍ	NO	408	113
83142	ES162	S42	1-3/8"	A	23.92	14.5	9.43	SÍ	SÍ	367	131
83143	ES162	S42	1-3/8"	A	21.92	13.5	8.43	SÍ	SÍ	403	137
83144	ES36	ES36	1-3/8"	A	23.78	15.03	8.75	SÍ	SÍ	596	93
83145	ES83	ES83	1-3/8"	A	19.93	12.32	7.54	SÍ	NO	479	153
83146	ES90	ES83	1-3/8"	A	24.02	14.68	9.33	SÍ	SÍ	479	119
83147	ES179	ES179	1-3/8"	A	28.53	17.34	11.15	SÍ	SÍ	358	128
83148	ES179	ES179	1-3/8"	A	30	17.83	12.17	SÍ	SÍ	604	149
83149	ES36	ES36	1-3/8"	A	25.28	15.78	9.49	SÍ	SÍ	332	101
83150	ES36	ES36	1-3/8"	A	15.24	10.43	4.81	SÍ	SÍ	940	216
83153	ES34	ES34	1-3/8"	A	21.69	13.62	8.07	SÍ	SÍ	974	206
83154	ES120	S21	1-3/8"	A	20.78	12.72	8.06	SÍ	SÍ	599	140
83155	ES34	ES34	1-3/8"	A	21.69	13.62	8.07	SÍ	SÍ	507	80
83156	ES90	ES90	1-3/8"	A	18.55	11.91	6.64	SÍ	NO	778	135
83157	ES36	ES90	1-3/8"	A	26.38	15.76	10.61	SÍ	NO	446	303
83158	ES22	ES22	1-3/8"	A	12.96	8.97	4	SÍ	NO	783	484
83159	EB2	EB2	1-3/8"	A	21.62	13.4	8.14	SÍ	NO	658	149
83160	ES82	ES36	1-3/8"	A	24.31	14.9	9.37	SÍ	SÍ	920	161
83161	S1	EB1	1-3/8"	A	20.82	12.56	8.25	SÍ	NO	400	70
83162	S40	ES190	1-3/8"	A	24.35	14.69	9.67	SÍ	NO	877	52
83163	ES175	ES175	1-3/8"	A	20.75	13.01	7.74	SÍ	NO	828	98
83164	ES36	ES165	1-3/8"	C	24.22	14.59	9.63	SÍ	NO	426	274
83165	ES161	ES182	1-3/8"	A	27.78	17	10.78	SÍ	SÍ	900	305
83166	ES179	ES179	1-3/8"	A	25.28	15.78	9.49	SÍ	SÍ	622	132

\* Damping force, in pounds, to either extend or collapse the shock absorber at an average operating velocity. Fuerza de amortiguación en libras para extender o comprimir el amortiguador a una velocidad de operación promedio. La puissance d'amortissement en poids de l'amortisseur, soit comprimé, doit détendu, à une vitesse de fonctionnement moyenne.

## ESPECIFICACIONES POR NÚMERO DE PARTE

GRC	Montajes		Calibre de Pistón	Imagen de Diámetro Exterior	Longitudes [in]			Polvera	Tope Hidráulico	Fuerza*	
	Superior	Inferior			Extendido	Comprimido	Carrera			Rebote	Compresión
83167	ES90	ES90	1-3/8"	A	19.49	12.38	7.11	SÍ	NO	285	90
83168	ES179	ES179	1-3/8"	A	25.28	15.78	9.49	SÍ	SÍ	246	88
83169	ES90	ES90	1-3/8"	A	18.55	11.91	6.64	SÍ	NO	599	171
83171		ES36	1-3/8"	A	23.98	14.51	9.47	SÍ	SÍ	513	146
83172	ES184	ES184	1-3/8"	C	26.56	17.08	9.48	SÍ	NO	1085	340
83173	S43	S43	1-3/8"	A	23.17	14.02	9.15	SÍ	NO	1020	105
83174	ES82	ES36	1-3/8"	A	24.31	14.9	9.37	SÍ	SÍ	795	160
83175	ES175	ES175	1-3/8"	A	20.48	13.19	7.29	SÍ	NO	1245	156
83176	ES36	ES36	1-3/8"	A	26.62	15.96	10.66	NO	NO	406	275
83177	S40	EB1	1-3/8"	A	14.99†	10.12	5.38	SÍ	NO	690	275
83178	S38	ES83	1-3/8"	A	21.95	13.26	8.69	SÍ	NO	690	275
83179	EB2	EB2	1-3/8"	A	10.76†	8.57†	3.02	SÍ	NO	909	278
83200	EB2	EB2	1-3/8"	A	24.51	15.1	9.53	SÍ	NO	806	370
83203	ES36	ES36	1-3/8"	A	17.1	11.36	5.74	SÍ	SÍ	609	114
83204	ES36	ES36	1-3/8"	A	20.14	12.86	7.28	SÍ	SÍ	451	110
83205	ES36	ES36	1-3/8"	A	29.69	17.69	12	SÍ	SÍ	660	76
83207	ES36	ES36	1-3/8"	A	21.64	13.61	8.03	SÍ	SÍ	553	143
83209	ES36	ES36	1-3/8"	A	29.64	17.61	12.03	SÍ	SÍ	670	78
83214	EB3	EB3	1-3/8"	A	19.64	12.86	6.78	SÍ	NO	269	90
83215	EB3	EB3	1-3/8"	A	26.64	16.36	10.28	SÍ	SÍ	697	108
83216	EB2	EB2	1-3/8"	A	23.51	14.48	9.03	SÍ	NO	776	262
83217	EB3	EB3	1-3/8"	A	22.77	14.49	8.28	SÍ	SÍ	539	202
83218	ES36	ES36	1-3/8"	A	25.19	15.44	9.75	SÍ	SÍ	721	194
83219	EB2	EB2	1-3/8"	A	20.01	12.73	7.28	SÍ	NO	299	125
83221	ES36	ES36	1-3/8"	A	24.01	14.73	9.28	SÍ	NO	599	153
83225	EB3	EB3	1-3/8"	A	24.14	15.11	9.03	SÍ	SÍ	482	159
83242	ES36	ES36	1-3/8"	A	33.73	20.98	12.75	SÍ	SÍ	721	135
83301	S16	ES90	1-3/8"	B	24.52	14.74	9.78	SÍ	SÍ	653	86
83303	EB7	ES36	1-3/8"	B	24.86	15.08	9.78	SÍ	NO	470	122
83304	EB7	ES36	1-3/8"	B	22.86	14.08	8.78	SÍ	NO	470	122
83308	EB2	EB2	1-3/8"	B	25.14	15.36	9.78	SÍ	SÍ	445	180
83309	EB2	EB2	1-3/8"	B	28.64	17.11	11.53	SÍ	SÍ	589	135
83310	ES36	ES36	1-3/8"	B	24.06	14.69	9.37	SÍ	NO	559	153
83312	EB2	EB2	1-3/8"	B	26.64	16.11	10.53	SÍ	SÍ	527	152
83314	EB2	EB2	1-3/8"	B	30.64	18.11	12.53	SÍ	SÍ	633	143
83317	S16	ES90	1-3/8"	B	27.03	16	11.34	SÍ	SÍ		
83318	S16	S16	1-3/8"	B	22.53	13.5	9.03	SÍ	SÍ	323	77
83353	EB3	S21	1-3/8"	B	24.84	15.06	9.78	SÍ	NO	432	214
83362	EB3	EB3	1-3/8"	B	27	16.25	10.75	SÍ	NO	539	202
83400	S1	S1	1-3/16"	F	22.02	12.82	9.2	SÍ	NO	301	120
83401	EB1	EB1	1-3/16"	F	24.09	14.26	9.83	SÍ	NO	341	252
83404	EB2	EB2	1-3/16"	F	22.01	13.44	8.58	SÍ	NO	545	171
83456	S21	S21	1-3/8"	B	24.03	14.25	9.78	SÍ	NO	566	80

\* Damping force, in pounds, to either extend or collapse the shock absorber at an average operating velocity. Fuerza de amortiguación en libras para extender o comprimir el amortiguador a una velocidad de operación promedio. La puissance d'amortissement en poids de l'amortisseur, soit comprimé, doit détendu, à une vitesse de fonctionnement moyenne.

† At bumper contact / Al contacto con el tope de goma / Au contact avec le butoir

## ESPECIFICACIONES POR NÚMERO DE PARTE

GRC	Montajes		Calibre de Pistón	Imagen de Diámetro Exterior	Longitudes [in]			Polvera	Tope Hidráulico	Fuerza*	
	Superior	Inferior			Extendido	Comprimido	Carrera			Rebote	Compresión
83505	EB2	EB2	1-3/16"	F	25	14.94	10.06	SÍ	NO	399	141
83506	EB2	EB2	1-3/16"	F	22.6	13.76	8.84	SÍ	NO	441	119
83507	S1	ES83	1-3/16"	F	24.14	14.16	9.99	SÍ	NO	395	87
83508	EB1	EB1	1-3/16"		20.76	12.62	8.14	SÍ	NO	698	183
83509	S1	EB1	1-3/16"		21.45	12.76	8.69	SÍ	NO	567	250
83510	EB1	EB1	1-3/16"		21.2	13.09	8.11	SÍ	NO	463	41
83511	EB2	EB2	1-3/16"		17.73	11.32	6.41	SÍ	NO	615	274
83512	S38	EB2	1-3/16"		21.65	12.99	8.66	SÍ	NO	768	167
83513	S1	EB2	1-3/16"		23.74	13.98	9.76	SÍ	NO	353	186
83514	S1	EB2	1-3/16"		23.74	13.98	9.76	SÍ	NO	430	145
83515	S1	EB2	1-3/16"		23.34	13.89	9.45	SÍ	NO	643	205
83613	S16	S16	1-3/8"	A	21.04	12.76	8.28	SÍ	SÍ	601	242
83634	ES120	ES120	1-3/8"	A	27.48	16.23	11.25	SÍ	SÍ	779	157
83635	ES36	S21	1-3/8"	A	21.74	13.25	8.49	SÍ	NO	558	119
83636	ES90	ES90	1-3/8"	A	27.72	16.95	10.77	SÍ	SÍ	505	148
85000	ES36	ES36	1-5/8"	C	17.22	11.46	5.76	SÍ	SÍ	1019	219
85001	EB3	EB3	1-5/8"	C	26.27	16.36	9.91	SÍ	NO	1202	186
85003	ES90	ES90	1-5/8"	C	25.37	15.59	9.78	SÍ	SÍ	437	182
85004	EB3	EB3	1-5/8"	C	20.68	13.67	7.01	SÍ	SÍ	1019	219
85005	ES36	ES36	1-5/8"	C	24.74	15.21	9.53	SÍ	SÍ	1019	219
85006	ES36	ES36	1-5/8"	C	28.5	17.09	11.41	SÍ	SÍ	1019	219
85007	EB3	EB3	1-5/8"	C	24.21	15.3	8.91	SÍ	SÍ	1008	171
85009	S21	ES36	1-5/8"	C	23.52	14.36	9.16	SÍ	SÍ	857	144
85010	ES36	ES36	1-5/8"	C	26.74	16.21	10.53	SÍ	SÍ	1019	219
85011	ES120	ES121	1-5/8"	C	27.49	16.46	11.03	SÍ	NO	1268	186
85012	EB2	EB2	1-5/8"	C	21	13.22	7.78	SÍ	NO	523	199
85013	ES36	ES36	1-5/8"	C	29.74	17.71	12.03	SÍ	SÍ	1019	219
85014	ES36	ES36	1-5/8"	C	21.74	13.71	8.03	SÍ	SÍ	1019	219
85023	EB2	EB2	1-5/8"	C	20.24	12.96	7.28	SÍ	SÍ	1008	539
85024	EB2	EB2	1-5/8"	C	28.74	17.21	11.53	SÍ	SÍ	1008	539
85025	EB2	S21	1-5/8"	C	23	13.97	9.03	SÍ	NO	1079	539
85026	ES136	S21	1-5/8"	C	23	13.97	9.03	SÍ	NO	1079	539
85027	S21	S21	1-5/8"	C	21.52	12.99	8.53	SÍ	NO	1008	539
85029	ES36	ES36	1-5/8"	C	20.5	13.09	7.41	SÍ	SÍ	1019	219
85030	ES36	ES36	1-5/8"	C	24	14.84	9.16	SÍ	SÍ	1019	219
85031	ES176	EB2	1-5/8"	C	25.63	15.85	9.78	SÍ	NO	941	257
85033	S21	EB3	1-5/8"	C	27.21	17.37	9.84	SÍ	SÍ	764	254
85036	ES36	ES36	1-5/8"	C	26.38	16.29	10.09	SÍ	SÍ	633	119
85040	EB3	EB3	1-5/8"	C	30.9	18.49	12.41	SÍ	NO	889	114
85042	EB3	EB3	1-5/8"	C	20.64	13.61	7.03	SÍ	SÍ	333	161
85043	ES36	ES36	1-5/8"	C	27.63	16.85	10.78	SÍ	SÍ	628	163
85044	ES36	ES36	1-5/8"	C	22.63	14.1	8.53	SÍ	NO	722	212
85045	ES36	ES36	1-5/8"	C	14.51	10.1	4.41	SÍ	SÍ	1020	219

\* Damping force, in pounds, to either extend or collapse the shock absorber at an average operating velocity. Fuerza de amortiguación en libras para extender o comprimir el amortiguador a una velocidad de operación promedio. La puissance d'amortissement en poids de l'amortisseur, soit comprimé, doit détendu, à une vitesse de fonctionnement moyenne.

## ESPECIFICACIONES POR NÚMERO DE PARTE

GRC	Montajes		Calibre de Pistón	Imagen de Diámetro Exterior	Longitudes [in]			Polvera	Tope Hidráulico	Fuerza*	
	Superior	Inferior			Extendido	Comprimido	Carrera			Rebote	Compresión
85046	EB2	EB2	1-5/8"	C	27.51	16.6	10.91	SÍ	SÍ	1008	539
85047	EB2	EB2	1-5/8"	C	25.25	15.47	9.78	SÍ	SÍ	1008	539
85048	S21	S21	1-5/8"	C	29.16	16.88	12.28	SÍ	NO	432	106
85049	S21	S21	1-5/8"	C	25.53	15	10.53	SÍ	NO	597	107
85050	ES36	ES36	1-5/8"	C	23.28	14.5	9.03	SÍ	NO	525	138
85051	ES36	ES36	1-5/8"	C	18.53	12.15	6.4	SÍ	SÍ	1019	139
85052	ES36	ES36	1-5/8"	C	13.25	9.47	3.78	SÍ	SÍ	1019	139
85053	EB3	EB3	1-5/8"	C	24.65	15.49	9.16	SÍ	NO	1019	227
85054	EB2	EB2	1-5/8"	C	23.26	14.35	8.91	SÍ	NO	602	104
85055	EB2	EB2	1-5/8"	C	25.63	15.6	10.03	SÍ	NO	577	102
85056	S21	ES36	1-5/8"	C	20.15	12.87	7.28	SÍ	SÍ	732	114
85057	ES36	EB3	1-5/8"	C	21.45	14.23	7.22	SÍ	SÍ	1216	115
85058	ES36	ES36	1-5/8"	C	22.63	14.22	8.41	SÍ	SÍ	722	114
85059	ES36	EB3	1-5/8"	C	19.07	12.79	6.28	SÍ	SÍ	928	151
85060	ES36	ES36	1-5/8"	C	19.75	12.72	7.03	SÍ	SÍ	943	405
85061	ES161	ES162	1-5/8"	C	24.75	15.22	9.53	SÍ	SÍ	1216	195
85062	EB2	EB2	1-5/8"	C	19.76	12.6	7.2	SÍ	NO	523	199
85063	EB2	EB2	1-5/8"	C	32.01	18.85	13.16	SÍ	NO	762	174
85064	ES36	ES36	1-5/8"	C	16.03	10.76	5.27	SÍ	SÍ	1481	340
85065	ES161	S21	1-5/8"	C	28.02	16.99	11.03	SÍ	SÍ	1059	300
85066	ES161	ES162	1-5/8"	C	24.63	15.22	9.41	SÍ	SÍ	812	322
85067	ES174	ES136	1-5/8"	C	30.51	18.1	12.41	SÍ	SÍ	676	170
85069	S21	S21	1-5/8"	C	26.28	15.94	10.34	SÍ	SÍ	762	255
85070	ES174	EB3	1-5/8"	C	25.6	15.82	9.78	SÍ	NO	1100	310
85071	S21	S21	1-5/8"	C	25.57	15.04	10.53	SÍ	NO	610	107
85072	ES36	ES176	1-5/8"	C	24.17	14.83	9.34	SÍ	SÍ	1387	305
85073	S21	ES56	1-5/8"	C	26.12	15.67	10.45	SÍ	SÍ	1250	152
85074	EB2	EB2	1-5/8"	C	24.01	14.85	9.15	SÍ	SÍ	1021	126
85075	ES160	ES160	1-5/8"	C	26.37	16.43	9.84	SÍ	SÍ	1074	272
85076	ES177	ES56	1-5/8"	C	27	16.35	10.65	SÍ	SÍ	1008	149
85077	EB2	ES56	1-5/8"	C	23.97	14.85	9.12	SÍ	SÍ	955	120
85078	ES36	ES36	1-5/8"	C	14.77	10.13	4.64	SÍ	SÍ	1409	282
85079	ES36	ES36	1-5/8"	C	12.04	8.87	3.17	SÍ	SÍ	1494	325
85080	ES175	S21	1-5/8"	C	22.51	13.78	8.74	SÍ	NO	447	138
85081	ES175	S21	1-5/8"	C	23.44	14.33	9.11	SÍ	SÍ	1658	250
85082	ES90	ES90	1-5/8"	C	28.6	20.64	7.97	SÍ	SÍ	1435	266
85083	ES162	S42	1-5/8"	C	27.81	16.53	11.28	SÍ	SÍ	1429	184
85084	ES174	ES136	1-5/8"	C	20.59	13.03	7.57	SÍ	NO	1145	407
85085	S21	S21	1-5/8"	C	24.95	14.67	10.23	SÍ	NO	970	101
85086	ES36	ES36	1-5/8"	C	17.55	11.63	5.92	SÍ	SÍ	2027	389
85087	ES36	ES176	1-5/8"	C	22.79	14.71	8.08	SÍ	SÍ	1568	403
85088	ES161	ES162	1-5/8"	C	25.31	15.52	9.78	SÍ	SÍ	616	178
85089	ES161	ES162	1-5/8"	C	25.78	16.56	9.22	SÍ	SÍ	1316	152

\* Damping force, in pounds, to either extend or collapse the shock absorber at an average operating velocity. Fuerza de amortiguación en libras para extender o comprimir el amortiguador a una velocidad de operación promedio. La puissance d'amortissement en poids de l'amortisseur, soit comprimé, soit détendu, à une vitesse de fonctionnement moyenne.

## ESPECIFICACIONES POR NÚMERO DE PARTE

GRC	Montajes		Calibre de Pistón	Imagen de Diámetro Exterior	Longitudes [in]			Polvera	Tope Hidráulico	Fuerza*	
	Superior	Inferior			Extendido	Comprimido	Carrera			Rebote	Compresión
85090	ES150	ES36	1-5/8"	C	25.31	15.52	9.78	SÍ	SÍ	943	99
85091	ES36	ES36	1-5/8"	C	21.38	13.56	7.82	SÍ	NO	1121	331
85092	ES150	S21	1-5/8"	C	21.95	15.04	6.89	SÍ	SÍ	1597	138
85093	S21	S21	1-5/8"	C	22.46	13.85	8.61	SÍ	NO	1103	114
85094	ES161	ES182	1-5/8"	C	27.88	17.3	10.57	SÍ	NO	1345	334
85095	ES121	ES121	1-5/8"	C	25.28	15.45	9.83	SÍ	NO	1653	119
85096	ES120	S21	1-5/8"	C	25.31	16.23	9.08	SÍ	NO	1548	155
85097	ES36	ES36	1-5/8"	C	27.95	17.11	10.84	SÍ	SÍ	1086	109
85098	ES161	ES162	1-5/8"	C	24.64	15.25	9.39	SÍ	SÍ	747	158
85099	ES36	ES36	1-5/8"	C	26.02	15.93	10.09	SÍ	SÍ	1152	135
85100	ES136	ES136	1-5/8"	C	27.01	16.28	10.73	SÍ	NO	1036	264
85102	ES36	ES136	1-5/8"	C	21.53	14.94	6.59	SÍ	SÍ	1224	342
85103	ES120	S42	1-5/8"	C	24.28	14.64	9.64	SÍ	NO	762	213
85106	ES150	ES150	1-5/8"	C	20.03	12.89	7.14	SÍ	SÍ	1054	109
85108	ES121	ES121	1-5/8"	C	28.54	17.14	11.4	SÍ	SÍ	1617	148
85109	ES36	ES195	1-5/8"	C	24.21	15.14	9.07	SÍ	SÍ	1123	149
85110	S21	S21	1-5/8"	C	19.18	12.12	7.06	SÍ	SÍ	2135	163
85117	S21	S21	1-5/8"	C	24.12	14.72	9.46	SÍ	SÍ	1149	152
85118	ES190	ES190	1-5/8"	C	24.69	15.52	9.17	SÍ	NO	575	195
85119	ES150	ES150	1-5/8"	C	21.39	13.81	7.68	SÍ	SÍ	1387	185
85120	ES175	ES175	1-5/8"	C	23.67	15.06	8.61	SÍ	NO	2083	519
85121	ES161	ES	1-5/8"	C	27.14	19.1	8.08	SÍ	SÍ	1429	199
85122	ES120	S21	1-5/8"	C	22.22	13.78	8.44	SÍ	SÍ	926	162
85123	ES120	S21	1-5/8"	C	21.49	13.26	8.23	SÍ	NO	1809	246
85300	EB3	EB3	1-5/8"	D	18	12.22	5.78	SÍ	SÍ	1435	676
85301	EB3	EB3	1-5/8"	D	31.92	19.03	12.89	SÍ	NO	1442	455
85302	EB3	EB3	1-5/8"	D	22.75	14.66	8.09	SÍ	NO	836	253
85303	EB3	EB3	1-5/8"	D	24.75	15.47	9.28	SÍ	NO	1019	221
85304	EB3	EB3	1-5/8"	D	22.25	14.22	8.03	SÍ	NO	767	325
85305	EB3	EB3	1-5/8"	D	27.25	16.72	10.53	SÍ	NO	1120	225
85307	EB3	EB3	1-5/8"	D	24.01	15.1	8.91	SÍ	NO	1094	173
85308	EB3	EB3	1-5/8"	D	25.13	15.85	9.28	SÍ	SÍ	764	254
85310	S21	S21	1-5/8"	D	18.65	11.74	6.91	SÍ	SÍ	1379	578
85311	S21	EB3	1-5/8"	D	23.95	14.79	9.16	SÍ	SÍ	764	254
85312	EB3	S21	1-5/8"	D	23.69	14.85	8.84	SÍ	SÍ	717	111
85313	EB3	EB3	1-5/8"	D	26.26	16.35	9.91	SÍ	SÍ	717	111
85314	EB3	EB3	1-5/8"	D	26.5	16.47	10.03	SÍ	SÍ	1216	169
85315	EB3	EB3	1-5/8"	D	29.66	18.15	11.51	SÍ	NO	380	142
85316	S21	ES36	1-5/8"	D	20.61	12.85	7.76	SÍ	NO	943	443
85317	S21	EB3	1-5/8"	D	27.18	17.42	9.76	SÍ	SÍ	764	254
85318	S21	S21	1-5/8"	D	27.37	16.36	11.01	SÍ	SÍ	1372	192
85319	S21	ES150	1-5/8"	D	22.2	13.92	8.28	SÍ	SÍ	988	454
85320	EB3	EB3	1-5/8"	D	26.13	16.35	9.78	SÍ	NO	970	308

\* Damping force, in pounds, to either extend or collapse the shock absorber at an average operating velocity. Fuerza de amortiguación en libras para extender o comprimir el amortiguador a una velocidad de operación promedio. La puissance d'amortissement en poids de l'amortisseur, soit comprimé, soit détendu, à une vitesse de fonctionnement moyenne.



## ESPECIFICACIONES POR NÚMERO DE PARTE

GRC	Montajes		Calibre de Pistón	Imagen de Diámetro Exterior	Longitudes [in]			Polvera	Tope Hidráulico	Fuerza*	
	Superior	Inferior			Extendido	Comprimido	Carrera			Rebote	Compresión
85321	ES36	ES36	1-5/8"	D	25.36	15.58	9.78	SÍ	SÍ	1435	676
85322	EB3	ES160	1-5/8"	D	15.26	11.85	3.41	SÍ	SÍ	764	162
85323	ES36	ES36	1-5/8"	D	17.36	11.58	5.78	SÍ	SÍ	1085	163
85324	S21	S21	1-5/8"	D	22.14	13.61	8.53	SÍ	NO	579	114
85325	S21	S21	1-5/8"	D	23.64	14.36	9.28	SÍ	NO	1024	240
85326	S21	S21	1-5/8"	D	19.64	12.36	7.28	SÍ	NO	799	142
85327	EB3	ES160	1-5/8"	D	16.01	12.1	3.91	SÍ	SÍ	764	162
85328	S21	S21	1-5/8"	D	25.64	15.36	10.28	SÍ	NO	930	383
85329	EB3	EB3	1-5/8"	D	24.5	15.47	9.03	SÍ	SÍ	1550	232
85330	EB3	S21	1-5/8"	D	22.44	14.16	8.28	SÍ	SÍ	1140	176
85331	ES158	ES159	1-5/8"	D	19.66	12.88	6.78	SÍ	SÍ	1757	396
85332	S42	ES36	1-5/8"	D	20.64	12.98	7.66	SÍ	SÍ	2351	967
85333	S42	ES36	1-5/8"	D	20.64	12.98	7.66	SÍ	SÍ	1241	534
85334	EB3	EB3	1-5/8"	D	14.5	10.47	4.03	SÍ	SÍ	1271	319
85335	ES158	ES159	1-5/8"	D	19.66	12.88	6.78	SÍ	SÍ	827	107
85336	S21	S21	1-5/8"	D	18.76	11.86	6.9	SÍ	NO	861	200
85337	ES36	ES36	1-5/8"	D	28.72	17.45	11.28	SÍ	SÍ	1318	374
85338	ES36	ES36	1-5/8"	D	19.47	12.7	6.77	SÍ	SÍ	1664	420
85339	EB3	EB3	1-5/8"	D	31.68	19.02	12.66	SÍ	SÍ	804	463
85340	ES188	S21	1-5/8"	D	26.46	15.85	10.61	SÍ	SÍ	1807	165
85341	ES188	S21	1-5/8"	D	30.95	18.1	12.85	SÍ	SÍ	1807	333
85342	S21	S21	1-5/8"	D	23.28	13.99	9.29	SÍ	NO	893	188
85343	S21	EB3	1-5/8"	D	22.96	14.79	8.17	SÍ	SÍ	858	289
85344	ES36	ES36	1-5/8"	D	13.22	9.45	3.77	SÍ	SÍ	1581	443
85345	ES36	ES36	1-5/8"	D	21.83	13.82	8.01	SÍ	SÍ	1093	219
85346	S21	S21	1-5/8"	D	22.12	13.48	8.64	SÍ	SÍ	2016	285
85347	S21	S21	1-5/8"	D	23.62	14.22	9.4	SÍ	SÍ	961	122
85376	EB3	EB3	1-5/8"	D	33.25	19.72	13.53	SÍ	NO	668	134
85377	ES182	ES182	1-5/8"	D	23.8	14.84	8.96	SÍ	SÍ	1937	570
85378	ES182	ES182	1-5/8"	D	23.8	14.84	8.96	SÍ	SÍ	1110	240
85379	EB3	S21	1-5/8"	D	22.69	14.4	8.29	SÍ	SÍ	1658	176
85380	EB3	S21	1-5/8"	D	23.95	14.79	9.15	SÍ	SÍ	1568	227
85381	ES161	BP35	1-5/8"	D	21.26	15.43	5.83	SÍ	SÍ	1719	815
85382	ES36	ES36	1-5/8"	D	20.22	13.07	7.15	SÍ	SÍ	1658	420
85700	EB3	EB3	1-5/8"	D	26.13	16.6	9.53	SÍ	SÍ	1446	328
85701	S21	S21	1-5/8"	D	15.64	10.36	5.28	SÍ	SÍ	914	204
85702	EB3	EB3	1-5/8"	D	23.76	15.85	7.91	SÍ	SÍ	1093	825
85703	S21	EB3	1-5/8"	D	29.57	18.54	11.03	SÍ	SÍ	1435	186
85704	EB3	EB3	1-5/8"	D	28.75	18.72	10.03	SÍ	SÍ	1435	186
85705	S21	S21	1-5/8"	D	23.65	14.24	9.41	SÍ	SÍ	639	436
85706	S21	S21	1-5/8"	D	23.65	14.24	9.41	SÍ	SÍ	1086	696
85707	S21	S21	2-1/16"	D	23.65	14.4	9.25	SÍ	SÍ	1761	986
85708	S21	S21	1-5/8"	D	20.64	12.86	7.78	SÍ	SÍ	914	204

\* Damping force, in pounds, to either extend or collapse the shock absorber at an average operating velocity. Fuerza de amortiguación en libras para extender o comprimir el amortiguador a una velocidad de operación promedio. La puissance d'amortissement en poids de l'amortisseur, soit comprimé, soit détendu, à une vitesse de fonctionnement moyenne.

## ESPECIFICACIONES POR NÚMERO DE PARTE

GRC	Montajes		Calibre de Pistón	Imagen de Diámetro Exterior	Longitudes [in]			Polvera	Tope Hidráulico	Fuerza*	
	Superior	Inferior			Extendido	Comprimido	Carrera			Rebote	Compresión
85709	S21	S21	1-5/8"	D	31.64	18.36	13.28	SÍ	SÍ	700	203
85710	S21	EB3	1-5/8"	D	23.45	15.1	8.34	SÍ	SÍ	994	248
85711	S21	EB3	1-5/8"	D	24.57	15.29	9.28	SÍ	SÍ	1435	208
85712	EB3	EB3	1-5/8"	D	20.5	13.47	7.03	SÍ	SÍ	1435	562
85713	EB3	EB3	1-5/8"	D	24.5	15.47	9.03	SÍ	SÍ	1157	180
85714	EB3	EB3	1-5/8"	D	25.13	15.85	9.28	SÍ	SÍ	1220	175
85715	EB3	EB3	1-5/8"	D	25.13	15.85	9.28	SÍ	SÍ	1915	200
85716	EB3	EB3	1-5/8"	D	22.01	14.35	7.66	SÍ	SÍ	1220	175
85717	EB3	EB3	1-5/8"	D	25.13	15.85	9.28	SÍ	SÍ	1915	200
85718	EB3	EB3	1-5/8"	D	22.13	15.04	7.09	SÍ	SÍ	2506	206
85719	EB3	EB3	1-5/8"	D	17.25	11.97	5.28	SÍ	SÍ	1517	213
85720	EB3	EB3	1-5/8"	D	20.5	13.47	7.03	SÍ	SÍ	1435	562
85722	S21	S21	1-5/8"	D	27.15	16.43	10.72	SÍ	SÍ	1264	369
85723	EB3	S21	1-5/8"	D	19.94	12.91	7.03	SÍ	SÍ	1318	248
85724	ES158	ES159	1-5/8"	D	22.78	14.5	8.28	SÍ	SÍ	1235	454
85727	S21	S21	1-5/8"	D	29.89	17.36	12.53	SÍ	SÍ	783	111
85728	S21	S21	1-5/8"	D	24.39	14.86	9.53	SÍ	SÍ	1435	510
85729	EB3	S21	1-5/8"	D	21.58	13.8	7.78	SÍ	SÍ	783	111
85730	EB3	EB3	1-5/8"	D	30.75	18.72	12.03	SÍ	SÍ	1517	293
85731	S21	EB3	1-5/8"	D	30.57	18.54	12.03	SÍ	SÍ	1517	293
85732	EB3	EB3	2-1/16"	E	22.13	15.11	7.03	SÍ	SÍ	2632	382
85733	EB3	S21	1-5/8"	D	23.57	14.73	8.84	SÍ	SÍ	717	111
85734	EB3	EB3	1-5/8"	D	20.74	13.71	7.03	SÍ	SÍ	1288	227
85735	EB3	EB3	1-5/8"	D	26.74	16.71	10.03	SÍ	SÍ	1288	227
85736	EB3	EB3	1-5/8"	D	23.62	15.21	8.41	SÍ	SÍ	1155	352
85737	ES173	ES173	1-5/8"	D	15.11	10.84	4.27	SÍ	SÍ	3066	782
85738	ES36	ES36	1-5/8"	D	17.47	11.7	5.77	SÍ	SÍ	1830	416
85739	ES187	ES187	1-5/8"	D	20.73	13.54	7.19	SÍ	SÍ	3247	334
85740	EB3	S21	1-5/8"	D	24.7	15.15	9.55	SÍ	SÍ	848	305
85745	S21	S21	1-5/8"	D	19.88	12.34	7.54	SÍ	SÍ	3064	231
85746	S21	S21	1-5/8"	D	19.88	12.34	7.54	SÍ	SÍ	1754	167
85900	S21	S21	1-5/8"	G	17.27	11.16	6.11	SÍ	SÍ	1467	337
85901	EB3	EB3	1-5/8"	G	29.05	17.64	11.41	SÍ	NO	1830	418
85902	S21	S21	1-5/8"	G	19.01	12.03	6.98	SÍ	SÍ	1441	267
85903	ES36	ES36	1-5/8"	G	31.99	19.13	12.86	SÍ	SÍ	666	113
85904	ES36	ES36	1-5/8"	G	27.61	16.88	10.73	SÍ	SÍ	666	113
85905	ES36	EB3	1-5/8"	G	23.81	16.16	7.66	SÍ	SÍ	1020	219
85906	ES36	ES36	1-5/8"	G	21.73	14	7.73	SÍ	SÍ	700	255
85907	ES36	EB3	1-5/8"	G	21.43	14.2	7.23	SÍ	SÍ	1216	251
85908	ES36	ES36	1-5/8"	G	18.48	12.25	6.23	SÍ	SÍ	1020	219
85909	ES36	ES36	1-5/8"	G	24.24	15.13	9.11	SÍ	SÍ	700	255
85910	ES36	ES36	1-5/8"	G	20.73	13.5	7.23	SÍ	SÍ	1074	219
85911	ES36	ES36	1-5/8"	G	16.86	11.5	5.36	SÍ	SÍ	1020	219

\* Damping force, in pounds, to either extend or collapse the shock absorber at an average operating velocity. Fuerza de amortiguación en libras para extender o comprimir el amortiguador a una velocidad de operación promedio. La puissance d'amortissement en poids de l'amortisseur, soit comprimé, doit détendu, à une vitesse de fonctionnement moyenne.

## ESPECIFICACIONES POR NÚMERO DE PARTE

GRC	Montajes		Calibre de Pistón	Imagen de Diámetro Exterior	Longitudes [in]			Polvera	Tope Hidráulico	Fuerza*	
	Superior	Inferior			Extendido	Comprimido	Carrera			Rebote	Compresión
85912	EB3	ES36	1-5/8"	G	18.68	12.57	6.11	SÍ	SÍ	1020	219
85913	ES36	EB3	1-5/8"	G	22.56	15.2	7.36	SÍ	SÍ	1020	219
85914	ES36	ES36	1-5/8"	G	14.36	10.25	4.11	SÍ	SÍ	1020	219
85915	ES36	EB3	1-5/8"	G	19.06	12.7	6.36	SÍ	SÍ	1020	219
85916	ES36	ES36	1-5/8"	G	24.61	15.51	9.11	SÍ	SÍ	1149	219
85918	ES150	ES150	1-5/8"	G	22.96	14.55	8.41	SÍ	NO	1726	412
85919	ES36	ES36	1-5/8"	G	22.48	14.25	8.23	SÍ	SÍ	1265	121
85920	ES150	ES150	1-5/8"	G	21.19	13.53	7.66	SÍ	NO	845	49
85921	S21	ES36	1-5/8"	G	22.03	13.5	8.53	SÍ	NO	2053	339
85922	ES150	ES150	1-5/8"	G	21.19	13.53	7.66	SÍ	NO	878	185
85923	ES177	ES161	1-5/8"	G	22.48	14.5	7.98	SÍ	SÍ	1940	221
85924	ES90	ES36	1-5/8"	G	20.41	12.96	7.46	SÍ	NO	1036	122
85925	ES90	ES90	1-5/8"	G	22.54	15.59	6.96	SÍ	NO	761	144
85926	ES90	ES90	1-5/8"	G	26.48	17.96	8.53	SÍ	SÍ	1387	279
85927	ES90	ES90	1-5/8"	G	24.74	15.38	9.36	SÍ	SÍ	1288	388
85928	ES90	ES90	1-5/8"	G	20.28	13.21	7.08	SÍ	NO	957	229
85929	ES90	ES90	1-5/8"	G	20.28	13.21	7.08	SÍ	NO	2214	267
85930	ES177	ES161	1-5/8"	G	17.86	12	5.86	SÍ	SÍ	1617	342
85931	ES177	ES161	1-5/8"	G	22.48	14.5	7.98	SÍ	SÍ	1435	220
85932	ES178	ES150	1-5/8"	G	21.23	13.62	7.61	SÍ	SÍ	1102	430
85933	ES175	ES175	1-5/8"	G	18.23	12.71	5.52	SÍ	SÍ	1089	383
85934	ES36	ES36	1-5/8"	G	17.73	12	5.73	SÍ	SÍ	3511	1063
85935	S21	ES36	1-5/8"	G	18.7	11.92	6.78	SÍ	NO	1054	419
85936	ES174	S43	1-5/8"	G	17.23	11.38	5.85	SÍ	SÍ	1479	337
85937	ES174	S43	1-5/8"	G	18.98	12.26	6.72	SÍ	SÍ	1479	337
85938	ES36	ES36	1-5/8"	G	16.06	10.78	5.28	SÍ	SÍ	1581	432
85939	ES36	ES36	1-5/8"	G	14.44	10.03	4.41	SÍ	SÍ	1719	420
85940	EB3	EB3	1-5/8"	G	32.75	19.8	12.95	SÍ	SÍ	1545	398
85941	EB3	EB3	1-5/8"	G	33.38	20.12	13.26	SÍ	SÍ	1263	161
85942	EB3	EB3	1-5/8"	G	29.25	17.99	11.26	SÍ	SÍ	968	91
85943	EB3	EB3	1-5/8"	G	29.33	17.99	11.34	SÍ	SÍ	1387	396
85944	EB3	EB3	1-5/8"	G	29.33	17.99	11.34	SÍ	SÍ	1093	136
85945	ES191	ES191	1-5/8"	G	26.38	16.66	9.72	SÍ	SÍ	1485	185
85946	ES191	ES191	1-5/8"	G	24.37	15.64	8.74	SÍ	SÍ	2074	160
85947	ES160	ES160	1-5/8"	G	32.79	19.8	12.99	SÍ	SÍ	1387	396
85948	EB3	EB3	1-5/8"	G	31.37	19.09	12.28	SÍ	SÍ	1485	236
85949	EB3	EB3	1-5/8"	G	32.75	19.76	12.99	SÍ	SÍ	968	136
85950	ES192	ES192	1-5/8"	G	27.33	16.98	10.35	SÍ	SÍ	1807	124
85951	EB3	EB3	1-5/8"	G	30.98	18.9	12.08	SÍ	SÍ	1545	397
85953	ES90	ES90	1-5/8"	G	26.13	15.86	10.27	SÍ	NO	2001	153
85954	ES90	ES36	1-5/8"	G	20.43	12.96	7.46	SÍ	NO	1812	148
85955	ES175	ES150	1-5/8"	G	21.25	13.66	7.59	SÍ	SÍ	1034	397
85956	ES183	ES184	1-5/8"	G	30.63	18.75	11.87	SÍ	SÍ	979	373

\* Damping force, in pounds, to either extend or collapse the shock absorber at an average operating velocity. Fuerza de amortiguación en libras para extender o comprimir el amortiguador a una velocidad de operación promedio. La puissance d'amortissement en poids de l'amortisseur, soit comprimé, soit détendu, à une vitesse de fonctionnement moyenne.

## ESPECIFICACIONES POR NÚMERO DE PARTE

GRC	Montajes		Calibre de Pistón	Imagen de Diámetro Exterior	Longitudes [in]			Polvera	Tope Hidráulico	Fuerza*	
	Superior	Inferior			Extendido	Comprimido	Carrera			Rebote	Compresión
85957	ES90	ES90	1-5/8"	G	20.78	13.15	7.63	SÍ	NO	1583	138
85958	ES150	ES150	1-5/8"	G	22.96	14.55	8.41	SÍ	SÍ	1926	281
85959	ES150	ES150	1-5/8"	G	21.19	13.53	7.66	SÍ	SÍ	1021	123
85961	ES178	ES176	1-5/8"	G	22.83	14.17	8.66	SÍ	SÍ	2206	240
85962	ES178	ES176	1-5/8"	G	21.8	13.66	8.15	SÍ	SÍ	2206	240
85963	ES90	ES36	1-5/8"	G	25.49	18.68	6.81	SÍ	SÍ	1490	206
85964	ES90	ES36	1-5/8"	G	25.49	18.68	6.81	SÍ	SÍ	1981	205
85965	ES178	ES161	1-5/8"	G	24.24	15.15	9.09	SÍ	SÍ	2206	238
85966	ES178	ES161	1-5/8"	G	23.25	14.64	8.62	SÍ	SÍ	2206	238
85967	ES178	ES176	1-5/8"	G	23.93	14.86	9.07	SÍ	SÍ	2206	238
85968	EB3	EB3	1-5/8"	G	19.87	13.39	6.48	SÍ	SÍ	1069	227
85969	ES90	ES36	1-5/8"	G	18.38	11.93	6.45	SÍ	NO	1612	125
85970	ES188	S21	1-5/8"	G	27.19	16.4	10.78	SÍ	SÍ	1092	147
85971	ES36	ES36	1-5/8"	G	22.55	14.17	8.38	SÍ	NO	2315	451
85972	ES36	ES36	1-5/8"	G	30.78	18.26	12.52	SÍ	NO	1493	261
85973	ES184	S21	1-5/8"	G	21.84	13.99	7.85	SÍ	NO	1726	640
85974	ES36	ES36	1-5/8"	G	26.02	16.11	9.91	SÍ	SÍ	3087	230
85975	ES36	ES36	1-5/8"	G	24.24	15.15	9.09	SÍ	SÍ	1658	219
85976	ES36	ES36	1-5/8"	G	29.91	18.13	11.79	SÍ	SÍ	582	138
85977	ES36	S42	1-5/8"	G	26.2	15.91	10.29	SÍ	SÍ	582	138
85978	ES179	ES179	1-5/8"	G	29.91	18.13	11.79	SÍ	SÍ	582	138
85979	ES36	ES36	1-5/8"	G	31.17	18.66	12.52	SÍ	SÍ	582	138
85980	ES179	ES179	1-5/8"	G	31.17	18.66	12.52	SÍ	SÍ	582	138
85981	S43	ES184	1-5/8"	G	27.15	16.78	10.37	SÍ	NO	1574	535
85982	S21	S21	1-5/8"	G	20.67	13.1	7.57	SÍ	SÍ	2241	440
85983	EB3	EB3	1-5/8"	G	22.95	14.7	8.25	SÍ	NO	1101	366
85984	ES158	ES150	1-5/8"	G	25.44	15.96	9.48	SÍ	SÍ	2248	1168
85985	ES174	S43	1-5/8"	G	19.04	12.31	6.73	SÍ	SÍ	2068	723
85986	ES175	ES150	1-5/8"	G	21.25	13.66	7.59	SÍ	SÍ	1754	221
85988	S21	EB3	1-5/8"	G	23.84	14.87	8.97	SÍ	SÍ	1200	138
85989	ES174	ES136	1-5/8"	G	20.78	13.15	7.63	SÍ	NO	1812	351
85993	ES184	S21	1-5/8"	G	22.19	13.99	8.2	SÍ	SÍ	2210	635
85994	ES90	ES36	1-5/8"	G	21.21	13.4	7.81	SÍ	NO	1824	263
85995	ES90	ES36	1-5/8"	G	23.5	14.52	8.98	SÍ	NO	1830	173
85996	S21	S21	1-5/8"	G	19.01	12.03	6.98	SÍ	SÍ	3039	752
85997	S21	S21	1-5/8"	G	17.27	11.16	6.11	SÍ	SÍ	3039	752
85998	ES90	ES90	1-5/8"	G	22.83	14.17	8.66	SÍ	NO	1345	178
85999	ES90	ES90	1-5/8"	G	19.84	12.79	7.05	SÍ	NO	2214	259
86200	ES194	ES194	45 MM	D	14.24	10.45	3.79	SÍ	SÍ	4238	688
86201	ES193	ES193	45 MM	D	13.26	9.94	3.32	SÍ	SÍ	4238	688
86202	ES193	ES193	45 MM	D	14.52	10.43	4.09	SÍ	SÍ	4238	688
86203	ES193	ES193	45 MM	D	16.88	11.61	5.27	SÍ	SÍ	4238	910
87000	S21	EB3	2-1/16"	E	24.46	15.21	9.25	SÍ	SÍ	1332	300

\* Damping force, in pounds, to either extend or collapse the shock absorber at an average operating velocity. Fuerza de amortiguación en libras para extender o comprimir el amortiguador a una velocidad de operación promedio. La puissance d'amortissement en poids de l'amortisseur, soit comprimé, soit détendu, à une vitesse de fonctionnement moyenne.

## ESPECIFICACIONES POR NÚMERO DE PARTE

GRC	Montajes		Calibre de Pistón	Imagen de Diámetro Exterior	Longitudes [in]			Polvera	Tope Hidráulico	Fuerza*	
	Superior	Inferior			Extendido	Comprimido	Carrera			Rebote	Compresión
87001	EB3	EB3	2-1/16"	E	20.76	13.76	7	SÍ	SÍ	1158	190
87002	EB3	EB3	2-1/16"	E	23.5	15.41	8.09	SÍ	SÍ	879	203
87003	EB3	EB3	2-1/16"	E	26.26	16.51	9.75	SÍ	SÍ	1332	395
87004	EB3	EB3	2-1/16"	E	26.76	16.76	10	SÍ	SÍ	1158	190
87006	EB3	EB3	2-1/16"	E	23.75	15.25	8.5	SÍ	SÍ	1158	272
87007	S21	S21	2-1/16"	E	15.65	14.4	5.25	SÍ	SÍ	879	253
87011	S21	S21	2-1/16"	E	23.65	14.4	9.25	SÍ	SÍ	1750	1050
87012	S21	S21	2-1/16"	E	23.65	14.4	9.25	SÍ	SÍ	650	364
87013	S21	S21	2-1/16"	E	23.65	14.4	9.25	SÍ	SÍ	1075	585
87015	ES173	ES173	45MM	E	15.51	11.18	4.33	SÍ	SÍ	4950	900
87016	S21	EB3	2-1/16"	E	21.17	13.91	7.26	SÍ	SÍ	1808	238
87017	ES160	ES160	2-1/16"	E	23.35	15.31	8.07	SÍ	SÍ	1876	220
87018	ES36	ES36	2-1/16"	E	17.36	11.71	5.65	SÍ	SÍ	2479	1000
87019	ES160	ES160	2-1/16"	E	24.84	15.85	8.9	SÍ	SÍ	2972	665
87020	S21	ES182	2-1/16"	E	25.35	16.17	9.18	SÍ	SÍ	2479	967
89401	EB2	EB2	1-5/8"	G	28.41	17.16	11.25	SÍ	NO	665‡	194
89402	EB2	EB2	1-5/8"	G	24.41	15.16	9.25	SÍ	NO	874‡	206
89403	EB2	EB2	1-5/8"	G	26.86	17.16	9.7	SÍ	SÍ	929‡	281
89405	ES36	ES36	1-5/8"	G	26.24	16.41	9.83	SÍ	SÍ	1009‡	249
89406	ES36	ES36	1-5/8"	G	24.74	15.66	9.08	SÍ	SÍ	658‡	125
89407	ES36	ES36	1-5/8"	G	21.62	14.04	7.58	SÍ	SÍ	652‡	218
89408	EB2	EB2	1-5/8"	G	19.67	12.79	6.88	SÍ	NO	536‡	201
89409	EB2	EB2	1-5/8"	G	26.36	16.41	9.95	SÍ	SÍ	567‡	165
89410	EB3	EB3	1-5/8"	G	26.33	16.42	9.91	SÍ	NO	1185‡	182
89411	ES90	ES90	1-5/8"	G	25.36	15.59	9.78	SÍ	SÍ	436‡	186
89412	EB3	EB3	1-5/8"	G	24.26	15.68	8.58	SÍ	SÍ	1155‡	169
89413	EB2	EB2	1-5/8"	G	20.91	13.41	7.5	SÍ	NO	536‡	201
89414	ES36	ES36	1-5/8"	G	29.62	18.04	11.58	SÍ	SÍ	1045‡	217
89415	EB2	EB2	1-5/8"	G	20.12	13.29	6.83	SÍ	SÍ	1155‡	514
89416	EB2	EB2	1-5/8"	G	28.62	17.54	11.08	SÍ	SÍ	1155‡	514
89417	ES136	S21	1-5/8"	G	22.93	14.18	8.75	SÍ	NO	1226‡	515
89418	S21	S21	1-5/8"	G	21.44	13.19	8.25	SÍ	NO	1266‡	515
89419	EB3	EB3	1-5/8"	G	18	12.55	5.45	SÍ	SÍ	1352‡	636
89420	EB3	EB3	1-5/8"	G	22.81	14.68	8.13	SÍ	NO	862‡	258
89422	EB3	EB3	1-5/8"	G	25.13	16.18	8.95	SÍ	SÍ	794‡	253
89423	S21	S21	1-5/8"	G	18.65	12.07	6.58	SÍ	SÍ	1352‡	573
89424	S21	EB3	1-5/8"	G	23.7	15	8.7	SÍ	SÍ	794‡	253
89425	EB3	EB3	1-5/8"	G	26.5	16.8	9.7	SÍ	SÍ	1352‡	167
89426	S21	ES36	1-5/8"	G	20.43	12.93	7.5	SÍ	NO	926‡	419
89427	S21	EB3	1-5/8"	G	27.2	17.5	9.7	SÍ	SÍ	794‡	253
89428	S21	ES150	1-5/8"	G	21.96	14.13	7.83	SÍ	SÍ	958‡	446
89429	EB3	EB3	1-5/8"	G	26.18	16.43	9.75	SÍ	NO	941‡	266
89430	ES36	ES36	1-5/8"	G	24.6	15.39	9.53	SÍ	SÍ	1462‡	279

\* Damping force, in pounds, to either extend or collapse the shock absorber at an average operating velocity. Fuerza de amortiguación en libras para extender o comprimir el amortiguador a una velocidad de operación promedio. La puissance d'amortissement en poids de l'amortisseur, soit comprimé, doit détendu, à une vitesse de fonctionnement moyenne.

‡ For GasSLX Series, forces are at the "Firm" (F) setting. / Para la serie GasSLX, las fuerzas están ajustadas en (F) "Firme". / Pour la série GasSLX, le réglage de la force est sur «Ferme» (F).

## ESPECIFICACIONES POR NÚMERO DE PARTE

GRC	Montajes		Calibre de Pistón	Imagen de Diámetro Exterior	Longitudes [in]			Polvera	Tope Hidráulico	Fuerza*	
	Superior	Inferior			Extendido	Comprimido	Carrera			Rebote	Compresión
89431	ES36	ES36	1-5/8"	G	22.41	14.16	8.25	SÍ	NO	751‡	211
89432	ES36	ES36	1-5/8"	G	23.41	14.66	8.75	SÍ	NO	1507‡	561
89434	EB2	EB2	1-5/8"	G	27.12	16.79	10.33	SÍ	SÍ	1155‡	514
89435	EB2	EB2	1-5/8"	G	24.86	15.66	9.2	SÍ	SÍ	1155‡	514
89436	ES36	ES36	1-5/8"	G	17.24	11.91	5.33	SÍ	SÍ	998‡	217
89437	ES36	ES36	1-5/8"	G	20.12	13.29	6.83	SÍ	SÍ	1155‡	514
89438	EB2	EB2	1-5/8"	G	23.17	14.54	8.63	SÍ	NO	583‡	103
89439	EB2	EB2	1-5/8"	G	25.67	15.79	9.88	SÍ	NO	518‡	103
89440	ES36	ES36	1-5/8"	G	23.86	15.16	8.7	SÍ	SÍ	1498‡	561
89441	S21	ES36	1-5/8"	G	20.14	13.06	7.08	SÍ	SÍ	761‡	126
89442	EB3	EB3	1-5/8"	G	24.55	15.55	9	SÍ	NO	1055‡	224
89443	ES158	ES159	1-5/8"	G	22.17	14.31	7.86	SÍ	SÍ	1206‡	466
89446	EB2	EB2	1-5/8"	G	28.36	17.41	10.95	SÍ	SÍ	702‡	204
89447	S21	S21	1-5/8"	G	23.65	14.57	9.08	SÍ	SÍ	702‡	241
89448	ES161	ES162	1-5/8"	G	24.62	15.54	9.08	SÍ	SÍ	782‡	323
89449	ES150	ES150	1-5/8"	G	23.09	14.71	8.38	SÍ	NO	1519‡	324
89450	ES161	ES162	1-5/8"	G	24.62	15.54	9.08	SÍ	SÍ	1282‡	193
89451	ES174	ES136	1-5/8"	G	30.36	18.41	11.95	SÍ	SÍ	645‡	172
89453	ES178	ES150	1-5/8"	G	21.1	13.78	7.32	SÍ	SÍ	860‡	435
89454	ES175	ES175	1-5/8"	G	18.23	12.78	5.45	SÍ	SÍ	938‡	388
89455	S21	S21	1-5/8"	G	26.28	15.92	10.36	SÍ	SÍ	791‡	276
89456	ES174	S43	1-5/8"	G	17.02	11.29	5.73	SÍ	SÍ	975‡	377
89457	ES90	ES36	1-5/8"	G	19.95	12.71	6.97	SÍ	NO	941‡	156
89458	ES177	ES161	1-5/8"	G	22.47	14.25	7.95	SÍ	SÍ	1575‡	222
89459	ES174	EB3	1-5/8"	G	25.62	15.86	9.78	SÍ	NO	1179‡	314
89460	ES174	ES136	1-5/8"	G	20.58	13.03	7.55	SÍ	NO	997‡	384
89461	ES160	ES160	1-5/8"	G	19.96	13.58	6.38	SÍ	SÍ	897‡	103
630811	0	0	1-3/16"		22.45	14.1	8.35	NO	NO		
632147	0	0	1-3/16"		22.45	14.1	8.35	NO	NO		
632155	ES36	ES36	1-3/16"		22.45	14.1	8.35	NO	NO		
646155	ES36	ES36	1-3/16"		22.45	14.1	8.35	SÍ	NO		
646177	ES36	ES36	1-3/16"		22.45	14.1	8.35	NO	NO		
665472	ES36	ES36	1-5/8"	G	25.14	15.61	9.53	NO	NO	925	977
665937	ES36	ES36	1-5/8"	G	22.91	16.09	6.82	SÍ	NO		
695406	S21	S21	2-1/16"	E	21.39	13.26	8.13	SÍ	SÍ	1854	274
6801SE	EB1	EB1			19.33	12.16	7.17				
6802SE	S1	S1			20.02	12.11	7.91				
6803SE	S1	S1			22.52	13.36	9.16				
6804SE	EB1	EB1			24.08	14.67	9.41				
6805SE	S1	EB1			21.2	12.59	8.61				
6807SE	EB1	EB1			19.73	12.12	7.61				
6826SE	S1	S1			21.17	12.31	8.86				
6828SE	EB1	EB1			21.23	12.87	8.36				

\* Damping force, in pounds, to either extend or collapse the shock absorber at an average operating velocity. Fuerza de amortiguación en libras para extender o comprimir el amortiguador a una velocidad de operación promedio. La puissance d'amortissement en poids de l'amortisseur, soit comprimé, doit détendu, à une vitesse de fonctionnement moyenne.

‡ For GasSLX Series, forces are at the "Firm" (F) setting. / Para la serie GasSLX, las fuerzas están ajustadas en (F) "Firme". / Pour la série GasSLX, le réglage de la force est sur «Ferme» (F).

## ESPECIFICACIONES POR NÚMERO DE PARTE

GRC	Montajes		Calibre de Pistón	Imagen de Diámetro Exterior	Longitudes [in]			Polvera	Tope Hidráulico	Fuerza*	
	Superior	Inferior			Extendido	Comprimido	Carrera			Rebote	Compresión
6846SE	ES65	ES65			22.6	13.68	8.92				
6847SE	EB1	ES65			23	13.83	9.17				
6848SE	ES62	ES109			18.04	11.18	6.86				
6849SE	S1	S1			20.17	11.81	8.36				
6850SE	EB1	S1			23.3	13.77	9.53				
6851SE	S1	S1			21.27	12.49	8.78				
6852SE	S1	S1			20.27	11.99	8.28				
6853SE	EB1	ES24			19.33	12.05	7.28				
6854SE	EB1	EB1			23.03	14.27	8.76				
6855SE	EB1	EB1			23.83	14.3	9.53				
6856SE	S1	EB1			27.3	15.77	11.53				
6857SE	S1	S1			21.27	12.49	8.78				
6858SE	S1	S1			21.27	12.49	8.78				
6859SE	S1	S1			20.27	11.99	8.28				
6860SE	S1	S1			20.27	11.99	8.28				
6861SE	S1	S1			20.27	11.99	8.28				
6862SE	S1	S1			20.27	11.99	8.28				
6863SE	S1	S1			20.27	11.99	8.28				
G244002					20.66	14.21	6.44				
G35066					20.43	13.78	6.65				
G35098					18.35	12.46	5.89				
G44450					22.17	14.55	7.62				
G44451					20.35	13.92	6.43				
G44459					20.32	13.41	6.91				
G44461					20.58	14.67	5.91				
G44477					24.98	16.77	8.21				
G44493					22.8	17.92	4.88				
G44495					20.74	14.65	6.09				
G44497					22.8	17.97	4.83				
G44713					26.08	18.74	7.34				
G44724					22.68	14.95	7.73				
G44735					21.95	14.35	7.6				
G44743					19.70	13.10	6.6				
G44745					24.66	17.48	7.18				
G44747					19.46	13.57	5.89				
G44748					20.07	14.14	5.93				
G44752					24.22	17.81	6.41				
G44763					19.95	13.82	6.13				
G44766					23.9	16.12	7.78				
G44767					21.04	14.21	6.84				
G44773					22.42	15.52	6.9				
G44774					21.36	14.13	7.23				
G44775					24.55	17.48	7.08				

\* Damping force, in pounds, to either extend or collapse the shock absorber at an average operating velocity. Fuerza de amortiguación en libras para extender o comprimir el amortiguador a una velocidad de operación promedio. La puissance d'amortissement en poids de l'amortisseur, soit comprimé, soit détendu, à une vitesse de fonctionnement moyenne.

## ESPECIFICACIONES POR NÚMERO DE PARTE

GRC	Montajes		Calibre de Pistón	Imagen de Diámetro Exterior	Longitudes [in]			Polvera	Tope Hidráulico	Fuerza*	
	Superior	Inferior			Extendido	Comprimido	Carrera			Rebote	Compresión
G44776					24.66	16.77	7.90				
G44783					20.81	13.66	7.15				
G44800					21.05	15.24	5.82				
G44802					21.78	15.17	6.61				
G44803					21.01	14.38	6.63				
G44850					22.3	15.42	6.88				
G44856					24.24	16.79	7.45				
G44862					22.98	16.78	6.2				
G44867					25.16	18.73	6.43				
G44868					23.14	17.33	5.82				
G44869					21.36	15.65	5.71				
G44898					23.87	16.14	7.73				
G44902					21.78	14.37	7.41				
G44903					19.81	13.59	6.22				
G44918					20.57	14.59	5.98				
G44920					25.22	18.02	7.2				
G44926					23.6	15.77	7.83				
G44934					21.90	15.20	6.71				
G44936					21.06	14.69	6.37				
G44937					22.68	16.53	6.16				
G44938					23.49	16.28	7.21				
G44939					19.72	13.66	6.07				
G44940					20.37	14.14	6.24				
G44941					25.17	18.67	6.5				
G44943					20.64	13.91	6.73				
G44944					19.18	13.29	5.90				
G44947					23.9	16.55	7.35				
G44968					20.91	14.41	6.5				
G44969					25.61	18.00	7.61				
G44982					19.72	13.66	6.07				
G44986					21.45	14.95	6.5				
G44990					24.79	16.89	7.90				
G44991					25.24	18.24	7				
G44994					19.84	14.20	5.64				
G44995					18.77	13.21	5.56				
G44997					21.76	14.76	7				
G44998					20.17	13.86	6.31				
G44999					20.93	14.23	6.7				
G51006					21.01	13.00	8.01				
G51007					21.87	13.86	8.01				
G51013					22.47	14.46	8.01				
G51017					23.31	14.55	8.76				
G51022					24.76	16.75	8.01				

\* Damping force, in pounds, to either extend or collapse the shock absorber at an average operating velocity. Fuerza de amortiguación en libras para extender o comprimir el amortiguador a una velocidad de operación promedio. La puissance d'amortissement en poids de l'amortisseur, soit comprimé, soit détendu, à une vitesse de fonctionnement moyenne.



## ESPECIFICACIONES POR NÚMERO DE PARTE

GRC	Montajes		Calibre de Pistón	Imagen de Diámetro Exterior	Longitudes [in]			Polvera	Tope Hidráulico	Fuerza*	
	Superior	Inferior			Extendido	Comprimido	Carrera			Rebote	Compresión
G51027					20.17	12.41	7.76				
G51030					23.24	14.72	8.53				
G51031					22	14.50	7.5				
G51033					23.85	15.59	8.26				
G51034					19.31	12.41	6.91				
G51039					23.41	15.28	8.14				
G51046					22.48	15.22	7.26				
G51047					20.17	12.41	7.76				
G51060					21.81	14.44	7.37				
G51063					21.31	13.05	8.26				
G51077					18.02	12.75	5.27				
G51078					20.79	13.69	7.1				
G51087					17.86	11.91	5.95				
G51097					22.83	18.07	4.76				
G51099					22.05	18.19	3.86				
G51100					23.62	15.9	7.72				
G51101					22.83	18.07	4.76				
G51165					21.26	13.44	7.82				
G51170					19.31	12.41	6.9				
G51173					17.27	11.00	6.27				
G51180					18	12.00	6				
G51181					21.31	13.36	7.95				
G51182					16.13	10.33	5.8				
G51183					16.1	10.33	5.77				
G51184					16.85	10.70	6.15				
G51186					19.48	12.72	6.76				
G51188					24.21	14.38	9.83				
G51189					17.81	12.18	5.63				
G51190					21.38	15.35	6.03				
G51191					21.18	15.07	6.11				
G51192					24.21	14.38	9.84				
G51193					20.81	14.09	6.72				
G51195					18.12	13.42	4.70				
G51196					14.93	9.95	4.98				
G51197					20.37	15.76	4.61				
G51204					18.63	14.83	3.8				
G51216					23.23	15.35	7.88				
G51227					12.00	7.13	4.87				
G51229					21.23	14.97	6.26				
G51230					16.2	10.98	5.22				
G51232					21.73	14.97	6.76				
G51249					24.48	16.97	7.51				
G51252					18.82	12.02	6.8				

\* Damping force, in pounds, to either extend or collapse the shock absorber at an average operating velocity. Fuerza de amortiguación en libras para extender o comprimir el amortiguador a una velocidad de operación promedio. La puissance d'amortissement en poids de l'amortisseur, soit comprimé, soit détendu, à une vitesse de fonctionnement moyenne.

## ESPECIFICACIONES POR NÚMERO DE PARTE

GRC	Montajes		Calibre de Pistón	Imagen de Diámetro Exterior	Longitudes [in]			Polvera	Tope Hidráulico	Fuerza*	
	Superior	Inferior			Extendido	Comprimido	Carrera			Rebote	Compresión
G51253					21.3	14.30	7				
G51254					21.3	14.30	7				
G51255					15.76	11.54	4.22				
G51256					22.66	15.45	7.22				
G51264					16.01	11.28	4.73				
G51267					14.25	10.70	3.55				
G51268					24.48	16.97	7.51				
G51279					16.37	11.07	5.3				
G51286					15.65	10.84	4.81				
G51290					19.78	13.07	6.71				
G51330					21.46	13.43	8.03				
G51424					20.23	12.97	7.26				
G51477					18.14	13.36	4.78				
G51700					14.68	10.35	4.33				
G51703					20.6	16.65	3.95				
G51704					21.69	16.62	5.07				
G51705					23.28	14.49	8.78				
G51706					22.46	14.93	7.54				
G51709					20.44	15.32	5.12				
G51710					23.08	16.02	7.06				
G51711					17.25	14.75	2.5				
G51712					21.1	14.80	6.3				
G51713					22	15.69	6.31				
G51714					16.79	11.99	4.8				
G51715					14.92	10.43	4.49				
G51716					14.68	10.35	4.33				
G51718					16.61	11.41	5.2				
G51719					19.84	15.70	4.14				
G51720					21.05	16.14	4.91				
G51721					24.88	17.95	6.94				
G51722					18.93	16.73	2.2				
G51723					18.93	16.73	2.2				
G51724					19.28	13.69	5.59				
G51725					21.12	14.62	6.5				
G51727					17.62	12.87	4.75				
G51728					13.87	9.62	4.25				
G51729					21.5	14.26	7.24				
G51730					15.42	10.11	5.31				
G51731					22.56	15.1	7.46				
G51733					26.76	16.68	10.08				
G51735					21.93	14.41	7.52				
G51736					16.5	11.50	5				
G51737					17.12	12.50	4.62				

\* Damping force, in pounds, to either extend or collapse the shock absorber at an average operating velocity. Fuerza de amortiguación en libras para extender o comprimir el amortiguador a una velocidad de operación promedio. La puissance d'amortissement en poids de l'amortisseur, soit comprimé, doit détendu, à une vitesse de fonctionnement moyenne.

## ESPECIFICACIONES POR NÚMERO DE PARTE

GRC	Montajes		Calibre de Pistón	Imagen de Diámetro Exterior	Longitudes [in]			Polvera	Tope Hidráulico	Fuerza*	
	Superior	Inferior			Extendido	Comprimido	Carrera			Rebote	Compresión
G51738					24.57	17.09	7.48				
G51739					21.36	16.79	4.57				
G51740	SS4				24.5	19	5.50				
G51742	S2				22.12	17.37	4.75				
G51743	SS4				22	18.12	3.88				
G51744					19.75	15.5	4.25				
G51746	SS2				22.12	17.37	4.75				
G51747					23.51	14.91	8.61				
G51756					20.37	17.75	2.62				
G51757					17.37	13.12	4.25				
G51758	SS6				21.5	15.34	5.85				
G51759	SS2				23.25	15.12	8.12				
G51760	SS6				25.17	19.37	5.8				
G51761	SS6				25.17	19.37	5.8				
G51764					19.69	14.36	5.33				
G51765					15.56	10.99	4.01				
G51766					15.56	10.99	4.01				
G51767					18.19	12.36	5.83				
G51768					16.87	12.12	4.75				
G51769					21.61	17.67	3.94				
G51770					20.37	17.75	2.62				
G51771					18.12	13.12	5				
G51772	S4				26	17.37	8.63				
G51773					18	13.5	4.50				
G51774					16.73	11.88	4.85				
G51783					24.41	14.45	9.96				
G51794					17.28	11.06	6.22				
G51795					18.78	12.008	6.77				
G51796					14.25	10.71	3.54				
G51798					15.35	11.1	4.25				
G51799					23.03	14.65	8.38				
G51802					20.83	14.09	6.74				
G51803					14.41	10.12	4.29				
G51804					26.18	15.83	10.35				
G51805					27.13	16.61	10.52				
G51806					15.74	11.339	4.41				
G51807					21.93	17.48	4.45				
G51810					19.17	13.27	5.90				
G51811					19.17	13.27	5.90				
G51812					19.96	13.94	6.02				
G51813					23.98	19.21	4.77				
G51814					23.98	19.21	4.77				
G51815					18.07	13.46	4.61				

\* Damping force, in pounds, to either extend or collapse the shock absorber at an average operating velocity. Fuerza de amortiguación en libras para extender o comprimir el amortiguador a una velocidad de operación promedio. La puissance d'amortissement en poids de l'amortisseur, soit comprimé, soit détendu, à une vitesse de fonctionnement moyenne.

## ESPECIFICACIONES POR NÚMERO DE PARTE

GRC	Montajes		Calibre de Pistón	Imagen de Diámetro Exterior	Longitudes [in]			Polvera	Tope Hidráulico	Fuerza*	
	Superior	Inferior			Extendido	Comprimido	Carrera			Rebote	Compresión
G51825					22.48	16.1	6.38				
G51826					28.54	20.47	8.07				
G51827					16.61	10.67	5.94				
G51828					16.61	10.67	5.94				
G51829					24.88	15.75	9.13				
G51830					14.92	10.55	4.37				
G51832					22.13	17.48	4.65				
G51836					19.53	16.69	2.83				
G51837					19.21	13.39	5.83				
G51838					19.02	12.72	6.3				
G51839					18.58	13.34	5.24				
G51841					20.98	14.29	6.69				
G51842					19.05	12.75	6.30				
G51847					24.8	17.04	7.76				
G51848					21.41	13.66	7.75				
G51849					17.95	12.36	5.59				
G51850					16.1	11.06	5.04				
G51852					13.89	10.66	3.23				
G51853					16.85	12	4.84				
G51854					16.85	12	4.84				
G51855					23.26	17.55	5.7				
G51856					21.18	15.11	6.07				
G51857					18.62	12.24	6.38				
G51858					15.35	11.18	4.17				
G51859					18.5	14.29	4.21				
G51860					19.96	16.29	3.67				
G51861					19.21	15.15	4.05				
G51863					20.30	12.48	7.83				
G51864					21.57	17.16	4.41				
G51865					20.86	16.45	4.41				
G51868					17.56	13.35	4.21				
G51869					18.23	13.7	4.53				
G51870					21.22	15.43					
G51871					15.7	11.77	3.93				
G51874					20.43	16.41	4.01				
G51875					18.11	12.32	5.79				
G51876					18.11	12.32	5.79				
G51877					17.67	12.91	4.76				
G51878					17.67	12.91	4.76				
G51879					15.67	10.94	4.73				
G51880					18.42	12	6.42				
G51881					16.57	11.65	4.92				
G51882					18.62	12.24	6.38				

\* Damping force, in pounds, to either extend or collapse the shock absorber at an average operating velocity. Fuerza de amortiguación en libras para extender o comprimir el amortiguador a una velocidad de operación promedio. La puissance d'amortissement en poids de l'amortisseur, soit comprimé, soit détendu, à une vitesse de fonctionnement moyenne.

## ESPECIFICACIONES POR NÚMERO DE PARTE

GRC	Montajes		Calibre de Pistón	Imagen de Diámetro Exterior	Longitudes [in]			Polvera	Tope Hidráulico	Fuerza*	
	Superior	Inferior			Extendido	Comprimido	Carrera			Rebote	Compresión
G51883					19.52	12.48	7.04				
G51884					16.53	13.5	3.03				
G51885					24.44	15.39	9.05				
G51886					16.22	10.74	5.48				
G51887					15.55	12.08	3.47				
G51888					15.55	12.08	3.47				
G51889					19.29	12.91	6.38				
G51890					19.29	12.91	6.38				
G51891					17.8	13.54	4.26				
G51892					23	15.86	7.14				
G51896					18.54	14.09	4.45				
G51897					18.54	14.09	4.45				
G51898					16.57	12.09	4.49				
G51899					17.04	11.73	5.31				
G51900					22.83	14.92	7.91				
G51901					22.4	19.32	3.07				
G51904					16.22	11.5	4.72				
G51905					23.74	17.79	5.95				
G51906					20.07	14.49	5.59				
G51907					21.34	13.74	7.6				
G51908					17.44	11.3	6.14				
G51909					18.3	12.68	5.63				
G51910					18.03	12.36	5.67				
G51911					18.86	15	3.86				
G51912					23.43	15.79	7.64				
G51913					23.43	15.79	7.64				
G51914					15.16	10.94	4.21				
G51915					27.56	19.32	8.23				
G51917					17.68	12.91	4.76				
G51918					17.68	12.91	4.76				
G51919					23.31	15.79	7.52				
G51922					20.91	16.64	4.25				
G51923					20.23	14.69	5.55				
G51924					22.56	15.28	7.28				
G51947					24.96	19.29	5.67				
G51948					24.96	19.29	5.67				
G51949					18.27	14.49	3.78				
G51953					21.77	19.32	2.44				
G51954					21.77	19.32	2.44				
G51955					17.32	14.33	2.99				
G52000					21.97	15.35	6.62				
G52001					21.97	15.35	6.62				
G52002					21.97	15.39	6.58				

\* Damping force, in pounds, to either extend or collapse the shock absorber at an average operating velocity. Fuerza de amortiguación en libras para extender o comprimir el amortiguador a una velocidad de operación promedio. La puissance d'amortissement en poids de l'amortisseur, soit comprimé, soit détendu, à une vitesse de fonctionnement moyenne.

## ESPECIFICACIONES POR NÚMERO DE PARTE

GRC	Montajes		Calibre de Pistón	Imagen de Diámetro Exterior	Longitudes [in]			Polvera	Tope Hidráulico	Fuerza*	
	Superior	Inferior			Extendido	Comprimido	Carrera			Rebote	Compresión
G52003					21.97	15.39	6.58				
G52004					21.02	14.69	6.33				
G52005					19.02	11.81	7.21				
G52006					19.02	11.81	7.21				
G52007					21.02	14.69	6.33				
G52008					22.2	15.04	7.16				
G52009					22.2	15.04	7.16				
G52011					20	13.54	6.46				
G52013					20.52	13.5	7.02				
G52014					20.52	13.5	7.02				
G52015					18.86	13.35	5.51				
G52016					18.86	13.35	5.51				
G52017					21.77	13.9	7.87				
G52018					21.77	13.9	7.87				
G52019					19.17	12.64	6.53				
G52020					19.17	12.64	6.53				
G52021					21.42	13.66	7.76				
G52022					21.42	13.66	7.76				
G52023					19.84	13.54	6.30				
G52024					19.84	13.54	6.30				
G52025					19.61	13.15	6.46				
G52026					22.8	14.84	7.96				
G52027					22.8	14.84	7.96				
G52028					20.47	12.68	7.79				
G52029					20.47	13.07	7.40				
G52030					24.88	17.95	6.93				
G52031					24.88	17.95	6.93				
G52032					21.54	14.13	7.41				
G52033					21.54	14.13	7.41				
G52034					21.38	14.41	6.97				
G52035					21.38	14.41	6.97				
G52036					19.37	15.04	4.33				
G52037					19.37	15.04	4.33				
G52038					20.04	13.11	6.93				
G52039					20.04	13.11	6.93				
G52040					21.34	14.65	6.69				
G52041					21.46	15.16	6.30				
G52043					21.85	14.53	7.32				
G52048					20.08	14.13	5.94				
G52055					18.82	12.76	6.06				
G52056					18.82	12.76	6.06				
G52057					18.11	13.31	4.8				
G52058					18.11	13.31	4.8				

\* Damping force, in pounds, to either extend or collapse the shock absorber at an average operating velocity. Fuerza de amortiguación en libras para extender o comprimir el amortiguador a una velocidad de operación promedio. La puissance d'amortissement en poids de l'amortisseur, soit comprimé, soit détendu, à une vitesse de fonctionnement moyenne.

## ESPECIFICACIONES POR NÚMERO DE PARTE

GRC	Montajes		Calibre de Pistón	Imagen de Diámetro Exterior	Longitudes [in]			Polvera	Tope Hidráulico	Fuerza*	
	Superior	Inferior			Extendido	Comprimido	Carrera			Rebote	Compresión
G52063					18.43	12.52	5.91				
G52064					21.875	14.125	7.75				
G52065					22.72	15.39	7.32				
G52066					20.7	13.62	7.08				
G52069					20.39	15.12	5.28				
G52070					20.39	15.12	5.28				
G52075					19.32	12.56	6.77				
G52076					19.32	12.56	6.77				
G52079					18.54	12.44	6.10				
G52080					18.54	12.44	6.10				
G52081					22.83	16.3	6.53				
G52082					22.83	16.3	6.53				
G52087					20.68	14.625	6.06				
G52088					24.56	14.625	9.94				
G52094					17.28	13.03	4.25				
G52095					17.28	13.03	4.25				
G52096					20.7	13.42	7.28				
G52097					20.7	13.42	7.28				
G52098					20.6	13.85	6.75				
G52103					24.13	15.82	8.31				
G52104					24.13	15.82	8.31				
G52105					23.3	16.57	6.73				
G52106					23.3	16.57	6.73				
G52107					23.22	16.18	7.04				
G52108					23.22	16.18	7.04				
G52110					18.14	11.96	6.19				
G52111					18.14	11.96	6.19				
G52112					21.41	14	7.41				
G52113					21.41	14	7.41				
G52116					19.29	13.07	6.22				
G52117					21.69	14.76	6.93				
G52118					21.69	14.76	6.93				
G52121					17.51	13.3	4.21				
G52122					17.51	13.3	4.21				
G52123					22.01	14.84	7.17				
G52124					22.01	14.84	7.17				
G52125					22	14.13	7.87				
G52127					23.3	15.6	7.7				
G52128					23.3	15.6	7.7				
G52129					17.82	11.49	6.34				
G52130					17.82	11.49	6.34				
G52131					22.71	15.74	6.97				
G52136					17.63	11.57	6.06				

\* Damping force, in pounds, to either extend or collapse the shock absorber at an average operating velocity. Fuerza de amortiguación en libras para extender o comprimir el amortiguador a una velocidad de operación promedio. La puissance d'amortissement en poids de l'amortisseur, soit comprimé, soit détendu, à une vitesse de fonctionnement moyenne.

## ESPECIFICACIONES POR NÚMERO DE PARTE

GRC	Montajes		Calibre de Pistón	Imagen de Diámetro Exterior	Longitudes [in]			Polvera	Tope Hidráulico	Fuerza*	
	Superior	Inferior			Extendido	Comprimido	Carrera			Rebote	Compresión
G52137					17.63	11.57	6.06				
G52138					16.96	11.02	5.94				
G52139					16.96	11.02	5.94				
G52140					24.13	16.97	7.16				
G52141					24.13	16.97	7.16				
G52142					18.38	14.05	4.33				
G52143					18.38	14.05	4.33				
G52144					20.35	15.39	4.96				
G52145					20.35	15.39	4.96				
G52148					22.12	14.76	7.36				
G52149					22.12	14.76	7.36				
G52150					24.68	16.69	7.99				
G52151					24.68	16.69	7.99				
G52152					21.77	13.93	7.84				
G52153					21.77	13.93	7.84				
G52154					19.29	12.52	6.77				
G52155					19.29	12.52	6.77				
G52156					19.84	12.59	7.25				
G52157					19.84	12.59	7.25				
G52158					23	15.94	7.06				
G52159					23	15.94	7.06				
G52160					19.68	13.15	6.53				
G52161					19.68	13.15	6.53				
G52162					22.2	14.13	8.07				
G52163					22.2	14.13	8.07				
G52164					16.25	10.78	5.47				
G52165					16.25	10.78	5.47				
G52166					21.22	13.81	7.41				
G52167					21.22	13.81	7.41				
G52168					21.61	14.17	7.44				
G52169					21.61	14.17	7.44				
G52170					20.9	16.02	4.88				
G52171					20.9	16.02	4.88				
G52172					20.66	16.32	4.33				
G52173					21.61	15.23	6.38				
G52174					21.61	15.23	6.38				
G52178					25	16.57	8.43				
G52179					25	16.57	8.43				
G52180					21.85	15.11	6.74				
G52181					21.85	15.11	6.74				
G52182					25.35	16.18	9.17				
G52183					25.35	16.18	9.17				
G52184					22.75	14.96	7.79				

\* Damping force, in pounds, to either extend or collapse the shock absorber at an average operating velocity. Fuerza de amortiguación en libras para extender o comprimir el amortiguador a una velocidad de operación promedio. La puissance d'amortissement en poids de l'amortisseur, soit comprimé, doit détendu, à une vitesse de fonctionnement moyenne.



## ESPECIFICACIONES POR NÚMERO DE PARTE

GRC	Montajes		Calibre de Pistón	Imagen de Diámetro Exterior	Longitudes [in]			Polvera	Tope Hidráulico	Fuerza*	
	Superior	Inferior			Extendido	Comprimido	Carrera			Rebote	Compresión
G52185					22.75	14.96	7.79				
G52187					23.26	14.8	8.46				
G52188					23.26	14.8	8.46				
G52193					19.09	14.29	4.8				
G52194					19.09	14.29	4.8				
G52199					19.44	14.76	4.68				
G52200					19.44	14.76	4.68				
G52201					22.51	15.94	6.57				
G52202					22.51	15.94	6.57				
G52203					26.33	17.95	8.38				
G52204					26.33	17.95	8.38				
G52205					20.47	17.67	2.8				
G52206					19.21	13.18	6.03				
G52209					19.21	13.18	6.03				
G52210					25.7	17	8.69				
G52227					19.84	13.93	5.91				
G52228					19.84	13.93	5.91				
G52237					19.64	14.92	4.72				
G52238					19.64	14.92	4.72				
G52244					23.15	15.82	7.33				
G52245					20.51	13.39	7.13				
G52246					20.51	13.39	7.13				
G52247					20.78	13.66	7.12				
G52248					20.78	13.66	7.12				
G52249					23.03	16.85	6.18				
G52250					23.03	16.85	6.18				
G52253					25.35	16.57	8.77				
G52254					25.35	16.57	8.77				
G52257					23.5	15.59	7.91				
G52258					23.5	15.59	7.91				
G52260					25.31	17.28	8.02				
G52261					25.31	17.28	8.02				
G52262					21.61	13.7	7.91				
G52263					21.61	13.7	7.91				
G52264					19.48	12.72	6.77				
G52265					19.48	12.72	6.77				
G52268					21.5	14.72	6.77				
G52269					21.5	14.72	6.77				
G52270					22.05	16.34	5.71				
G52271					22.05	16.34	5.71				
G52274					19.72	13.19	6.54				
G52275					19.72	13.19	6.54				
G52276					18.3	11.3	7.01				

\* Damping force, in pounds, to either extend or collapse the shock absorber at an average operating velocity. Fuerza de amortiguación en libras para extender o comprimir el amortiguador a una velocidad de operación promedio. La puissance d'amortissement en poids de l'amortisseur, soit comprimé, soit détendu, à une vitesse de fonctionnement moyenne.

## ESPECIFICACIONES POR NÚMERO DE PARTE

GRC	Montajes		Calibre de Pistón	Imagen de Diámetro Exterior	Longitudes [in]			Polvera	Tope Hidráulico	Fuerza*	
	Superior	Inferior			Extendido	Comprimido	Carrera			Rebote	Compresión
G52278					19.45	13.5	5.94				
G52279					19.45	13.5	5.94				
G52280					19.48	12.87	6.61				
G52281					19.48	12.87	6.61				
G52282					20.83	13.86	6.97				
G52283					20.83	13.86	6.97				
G52314					20.98	16.34	4.65				
G52333					22.44	13.78	8.66				
G52334					22.44	13.78	8.66				
G52335					21.46	14.06	7.4				
G52336					21.46	14.06	7.4				
G52346					18.86	13.31	5.55				
G52347					18.86	13.31	5.55				
G55505					16.98	10.40	6.58				
G55507					20.37	14.08	6.29				
G55509					19.36	13.35	6.01				
G55510					20.67	13.55	7.12				
G55511					17.89	11.85	6.05				
G55512					16.52	9.76	6.76				
G55514					16.98	10.40	6.58				
G55515					17.45	11.24	6.22				
G55516					20.39	13.41	6.99				
G55518					22.14	13.82	8.32				
G55521					17.37	11.06	6.31				
G55525					18.97	12.97	6.01				
G55526					17.41	10.83	6.58				
G55527					23.23	16.54	6.69				
G55529					20.03	12.50	7.53				
G55531					16.66	10.10	6.56				
G55533					20.94	13.65	7.29				
G55534					16.66	10.23	6.43				
G55539					18.02	11.95	6.07				
G55542					14.7	8.27	6.44				
G55544					16.66	10.26	6.4				
G55546					17.25	11.17	6.08				
G55551					24.1	14.50	9.6				
G55557					20	12.00	8				
G55561					16.38	9.84	6.54				
G55579					20.56	16.32	4.23				
G55580					20	12.50	7.5				
G55584					17.87	11.05	6.83				
G55586					16.32	9.67	6.65				
G55587					15.93	10.07	5.86				

\* Damping force, in pounds, to either extend or collapse the shock absorber at an average operating velocity. Fuerza de amortiguación en libras para extender o comprimir el amortiguador a una velocidad de operación promedio. La puissance d'amortissement en poids de l'amortisseur, soit comprimé, soit détendu, à une vitesse de fonctionnement moyenne.

## ESPECIFICACIONES POR NÚMERO DE PARTE

GRC	Montajes		Calibre de Pistón	Imagen de Diámetro Exterior	Longitudes [in]			Polvera	Tope Hidráulico	Fuerza*	
	Superior	Inferior			Extendido	Comprimido	Carrera			Rebote	Compresión
G55588					20.8	13.05	7.75				
G55589					20.44	12.69	7.76				
G55590					19.41	13.04	6.37				
G55591					16.94	10.76	6.18				
G55592					15.96	9.54	6.42				
G55593					17.7	12.05	5.65				
G55594					17.7	12.05	5.65				
G55600					16.09	9.60	6.49				
G55601					20	12.50	7.5				
G55602					16.68	9.69	6.99				
G55603					22.49	14.15	8.34				
G55605					15.93	10.03	5.9				
G55606					19.95	12.47	7.48				
G55607					15.22	9.41	5.81				
G55608					15.22	9.41	5.81				
G55609					16.34	10.65	5.69				
G55610					16.17	10.90	5.27				
G55611					16.17	10.80	5.37				
G55615					16.26	11.06	5.2				
G55616					20.19	13.73	6.46				
G55652					18.73	12.25	6.49				
G55653					18.73	12.25	6.49				
G55657					17.23	10.93	6.3				
G55658					17.23	10.93	6.3				
G55661					19.57	11.76	7.81				
G55662					19.57	11.76	7.81				
G55663					17.34	11.26	6.09				
G55664					17.34	11.26	6.09				
G55665					24.78	16.33	8.45				
G55666					16.65	10.61	6.04				
G55667					16.65	10.61	6.04				
G55668					20.34	12.83	7.51				
G55669					20.34	12.83	7.51				
G55670					15.39	9.73	5.66				
G55671					15.39	9.73	5.66				
G55672					19.05	12.57	6.48				
G55673					16.82	11.05	5.77				
G55675					20.84	12.64	8.20				
G55676					20.84	12.64	8.2				
G55679					15.72	10.10	5.62				
G55680					17	12.25	4.75				
G55681					20.69	14.36	6.34				
G55685					20.01	13.49	6.52				

\* Damping force, in pounds, to either extend or collapse the shock absorber at an average operating velocity. Fuerza de amortiguación en libras para extender o comprimir el amortiguador a una velocidad de operación promedio. La puissance d'amortissement en poids de l'amortisseur, soit comprimé, soit détendu, à une vitesse de fonctionnement moyenne.

## ESPECIFICACIONES POR NÚMERO DE PARTE

GRC	Montajes		Calibre de Pistón	Imagen de Diámetro Exterior	Longitudes [in]			Polvera	Tope Hidráulico	Fuerza*	
	Superior	Inferior			Extendido	Comprimido	Carrera			Rebote	Compresión
G55692					19.09	12.55	6.54				
G55693					24.59	15.59	9				
G55697					19.7	13.19	6.51				
G55698					19.92	13.14	6.78				
G55704					19.26	13.97	5.29				
G55705					19.01	12.00	7.01				
G55706					18.53	12.72	5.81				
G55707					20.11	14.24	5.87				
G55708					20.54	14.00	6.54				
G55710					16.67	9.7	6.97				
G55712					20.52	14.00	6.52				
G55713					17.79	11.43	6.36				
G55714					20.5	14.00	6.5				
G55715					19.42	13.5	5.92				
G55716					19.38	12.38	7				
G55719					18.2	11.36	6.84				
G55722					18.53	10.71	7.82				
G55723					13.84	8.52	5.32				
G55724					17.46	12.41	5.05				
G55725					16.58	10.7	5.88				
G55726					18.06	13.19	4.87				
G55727					17.87	10.23	7.63				
G55728					19.12	13.38	5.74				
G55729					22.78	14.16	8.62				
G55730					15.65	8.92	6.73				
G55731					18.21	10.38	7.83				
G55732					18.8	12.97	5.83				
G55733					21.61	13.82	7.79				
G55737					20.68	13.15	7.53				
G55738					20.68	13.15	7.53				
G55742					14.3	8.35	5.95				
G55743					14.35	8.36	5.99				
G55745					20.47	13.27	7.2				
G55746					20.31	11.56	8.75				
G55749					15.3	9.48	5.82				
G55752					22.75	14.63	8.12				
G55757					23.06	14.81	8.25				
G55763					15.56	9.88	5.68				
G55766					18.97	12.70	6.27				
G55769					24.35	15.03	9.32				
G55770					15.65	8.92	6.73				
G55771					18.99	13.42	5.58				
G55772					20.35	13.85	6.5				

\* Damping force, in pounds, to either extend or collapse the shock absorber at an average operating velocity. Fuerza de amortiguación en libras para extender o comprimir el amortiguador a una velocidad de operación promedio. La puissance d'amortissement en poids de l'amortisseur, soit comprimé, soit détendu, à une vitesse de fonctionnement moyenne.

## ESPECIFICACIONES POR NÚMERO DE PARTE

GRC	Montajes		Calibre de Pistón	Imagen de Diámetro Exterior	Longitudes [in]			Polvera	Tope Hidráulico	Fuerza*	
	Superior	Inferior			Extendido	Comprimido	Carrera			Rebote	Compresión
G55773					15.84	10.03	5.81				
G55774					15.24	10.55	4.7				
G55776					27.1	16.30	10.8				
G55780					17.43	11.09	6.34				
G55781					16	10.50	5.5				
G55782					18.89	13.02	5.87				
G55784					21.25	14.00	7.25				
G55785					21.25	14.00	7.25				
G55786					24.75	16.50	8.25				
G55787					16	10.25	5.75				
G55788					20.28	14.69	5.59				
G55795					18.25	11.25	7				
G55796					24.75	16.50	8.25				
G55797					17.9	11.00	6.9				
G55800					19.63	12.38	7.25				
G55801					17.25	10.25	7				
G55802					15.31	10.37	4.94				
G55803					18.92	13.23	5.69				
G55804					18.55	12.05	6.49				
G55805					24.5	18.00	6.5				
G55817					20.25	12.56	7.7				
G55818					14.41	10.71	3.7				
G55819					18	13.40	4.6				
G55820					16	11.25	4.75				
G55821					23.3	15.95	7.35				
G55825					22.88	17.33	5.55				
G55828					19	13.00	6				
G55831					23.26	15.67	7.59				
G55832					16.61	10.61	6				
G55833					16.61	10.61	6				
G55834					16.77	10.05	6.72				
G55847					18.5	12.00	6.5				
G55848					20.16	11.87	8.30				
G55849					15.71	9.86	5.85				
G55850					15.71	9.86	5.85				
G55856					23.37	14.26	9.11				
G55857					18.14	11.57	6.57				
G55858					18.14	11.57	6.57				
G55859					21.52	12.02	9.5				
G55860					21.52	12.02	9.5				
G55865					21.7	15.63	6.08				
G55866					21.7	15.63	6.08				
G55867					22.96	14.95	8.01				

\* Damping force, in pounds, to either extend or collapse the shock absorber at an average operating velocity. Fuerza de amortiguación en libras para extender o comprimir el amortiguador a una velocidad de operación promedio. La puissance d'amortissement en poids de l'amortisseur, soit comprimé, soit détendu, à une vitesse de fonctionnement moyenne.

## ESPECIFICACIONES POR NÚMERO DE PARTE

GRC	Montajes		Calibre de Pistón	Imagen de Diámetro Exterior	Longitudes [in]			Polvera	Tope Hidráulico	Fuerza*	
	Superior	Inferior			Extendido	Comprimido	Carrera			Rebote	Compresión
G55868					22.96	14.95	8.01				
G55870					16.78	11.56	5.22				
G55871					25.31	16.56	8.75				
G55877					15.24	10.55	4.7				
G55878					18.61	11.02	7.59				
G55879					16.51	10.28	6.23				
G55881					16.65	10.35	6.3				
G55882					16.65	10.35	6.3				
G55883					20.47	11.81	8.66				
G55884					20.47	11.81	8.66				
G55890					19.33	11.52	7.81				
G55891					15.53	9.78	5.75				
G55892					20.19	14.09	6.9				
G55893					24.41	16.46	7.95				
G55894					24.41	16.46	7.95				
G55896					20.2	14.1	6.10				
G55901					20.41	13.65	6.76				
G55903					13.88	7.84	6.04				
G55904					16.61	10.47	6.14				
G55909					15.32	10.38	4.95				
G55910					19.23	13.09	6.14				
G55911					16.22	9.72	6.5				
G55912					19.32	12.31	7.02				
G55913					19.32	12.31	7.02				
G55914					17.65	11.48	6.17				
G55920					16.87	11.13	5.74				
G55921					16.87	11.13	5.74				
G55923					20.75	13.74	7.01				
G55924					20.75	13.74	7.01				
G55925					20.63	14.21	6.42				
G55926					20.63	14.21	6.42				
G55927					21.38	12.82					
G55928					21.38	12.82					
G55929					22.99	15.12	7.87				
G55930					22.99	15.12	7.87				
G55931					22.47	14.00					
G55932					18.16	11.62	6.54				
G55933					21.75	14.00					
G55934					22.48	14.00	8.48				
G55945					16.20	10.36	5.84				
G55948					16.5	10.71	5.79				
G55949					23.13	16.09	7.05				
G55951					16.26	11.53	4.74				

\* Damping force, in pounds, to either extend or collapse the shock absorber at an average operating velocity. Fuerza de amortiguación en libras para extender o comprimir el amortiguador a una velocidad de operación promedio. La puissance d'amortissement en poids de l'amortisseur, soit comprimé, soit détendu, à une vitesse de fonctionnement moyenne.

## ESPECIFICACIONES POR NÚMERO DE PARTE

GRC	Montajes		Calibre de Pistón	Imagen de Diámetro Exterior	Longitudes [in]			Polvera	Tope Hidráulico	Fuerza*	
	Superior	Inferior			Extendido	Comprimido	Carrera			Rebote	Compresión
G55952					25.06	16.11	8.95				
G55958					16.26	11.53	4.74				
G55960					19.51	13.60	5.91				
G55970					17.63	11.90	5.73				
G55971					17.63	11.90	5.73				
G55974					18.01	11.14	6.88				
G55975					20.97	12.80	8.18				
G55976					20.23	12.12	8.11				
G55977					20.23	12.12	8.11				
G55978					19.51	13.60	5.91				
G55989					18.49	11.34	7.15				
G55990					17.93	11.32	6.61				
G55991					20.87	14.53	6.34				
G55992					16.99	10.40	6.59				
G55993					21.73	15.16	6.57				
G55994					21.73	15.16	6.57				
G55999					16.79	10.81	5.98				
G56501					20.18	12.01	8.18				
G56502					17.22	10.54	6.68				
G56503					20.01	14.25	5.76				
G56504					20.37	13.14	7.24				
G56506					17.22	10.54	6.68				
G56508					17.52	10.66	6.87				
G56509					16.82	10.66	6.17				
G56512					20.5	13.75	6.75				
G56513					20.5	13.75	6.75				
G56514					17.22	10.54	6.68				
G56515					16.15	8.44	7.71				
G56516					20.22	14.02	6.2				
G56517					20.22	13.94	6.28				
G56518					15.23	8.83	6.41				
G56520					18.95	12.56	6.39				
G56522					16.41	9.98	6.43				
G56523					22.5	14.00	8.5				
G56524					22.25	14.00	8.25				
G56525					16.91	10.48	6.43				
G56526					16.91	10.48	6.43				
G56527					19.06	11.60	7.46				
G56528					19.06	11.60	7.46				
G56529					16.9	10.55	6.35				
G56530					16.9	10.55	6.35				
G56531					18.37	12.62	5.75				
G56532					18.37	12.62	5.75				

\* Damping force, in pounds, to either extend or collapse the shock absorber at an average operating velocity. Fuerza de amortiguación en libras para extender o comprimir el amortiguador a una velocidad de operación promedio. La puissance d'amortissement en poids de l'amortisseur, soit comprimé, soit détendu, à une vitesse de fonctionnement moyenne.

## ESPECIFICACIONES POR NÚMERO DE PARTE

GRC	Montajes		Calibre de Pistón	Imagen de Diámetro Exterior	Longitudes [in]			Polvera	Tope Hidráulico	Fuerza*	
	Superior	Inferior			Extendido	Comprimido	Carrera			Rebote	Compresión
G56533					21.87	14.12	7.75				
G56534					21.87	14.12	7.75				
G56535					20.2	12.83	7.37				
G56536					23.39	15.00	8.39				
G56537					23.39	15.00	8.39				
G56538					23.39	15.00	8.39				
G56539					19.62	13.37	6.25				
G56540					19.62	13.37	6.25				
G56541					20.59	12.48	8.11				
G56542					20.59	12.48	8.11				
G56543					21.55	15.18	6.38				
G56544					21.55	15.18	6.38				
G56545					25.12	17.5	7.62				
G56546					25.12	17.5	7.62				
G56547					19.76	12.89	6.87				
G56548					19.76	12.89	6.87				
G56551					16.6	10.42	6.18				
G56552					16.6	10.42	6.18				
G56553					22.58	14.4	8.18				
G56554					22.58	14.4	8.18				
G56555					20.77	14.25	6.53				
G56556					20.77	14.25	6.53				
G56557					13.12	10.37	2.75				
G56558					20.98	14.44	6.54				
G56559					20.98	14.44	6.54				
G56561					23	16.37	6.62				
G56562					23	16.37	6.62				
G56565					16.77	11.81	4.96				
G56566					22.68	15.31	7.37				
G56568					25	17.75	7.25				
G56569					19.12	12.25	6.87				
G56570					19.12	12.25	6.87				
G56571					22.12	14.12	8				
G56572					20.55	13.66	6.89				
G56573					19.87	13.50	6.37				
G56574					23.5	16.00	7.5				
G56575					23.5	16.00	7.5				
G56576					19.87	13.50	6.37				
G56579					25.5	17.12	8.37				
G56580					25.5	17.12	8.37				
G56581					20.74	13.59	7.15				
G56582					20.74	13.59	7.15				
G56585					19.25	12.87	6.37				

\* Damping force, in pounds, to either extend or collapse the shock absorber at an average operating velocity. Fuerza de amortiguación en libras para extender o comprimir el amortiguador a una velocidad de operación promedio. La puissance d'amortissement en poids de l'amortisseur, soit comprimé, soit détendu, à une vitesse de fonctionnement moyenne.



## ESPECIFICACIONES POR NÚMERO DE PARTE

GRC	Montajes		Calibre de Pistón	Imagen de Diámetro Exterior	Longitudes [in]			Polvera	Tope Hidráulico	Fuerza*	
	Superior	Inferior			Extendido	Comprimido	Carrera			Rebote	Compresión
G56586					19.25	12.87	6.37				
G56587					16	11.75	4.25				
G56588					25.37	18.00	7.37				
G56589					25.37	18.00	7.37				
G56591	SS2				17.5	12.12	5.37				
G56592	SS2				20.75	15.75	5				
G56593					25.25	17.37	7.87				
G56594					20.03	15.23	4.8				
G56595					20.03	15.23	4.81				
G56596	SS2				18.25	13.50	4.75				
G56597					14.5	9.87	4.62				
G56598					19.74	15.23	4.51				
G56599					22.28	17.20	5.08				
G56601					25	17.75	7.25				
G56602					24.06	16.93	7.13				
G56603					24.06	16.93	7.13				
G56604					20.71	15.98	4.73				
G56605					20.71	15.98	4.73				
G56606					19.65	13.23	6.42				
G56607					16.14	11.81	4.33				
G56608					17.13	12.2	4.93				
G56611					19.25	12.97	6.28				
G56612					20.39	14.21	6.18				
G56615					22.62	16.00	6.62				
G56616					22.62	16.00	6.62				
G56618					18.75	12.87	5.88				
G56619					18.75	12.87	5.88				
G56620					18.6	12.14	6.47				
G56621					19.12	13.00	6.12				
G56622					19.12	13.00	6.12				
G56624					25.37	18.00	7.37				
G56625					25.37	18.00	7.37				
G56626					19.12	13	6.12				
G56627					19.12	13	6.12				
G56628	B2				21.5	13.62	7.87				
G56629	B2				21.5	13.62	7.87				
G56631					20.74	13.59	7.15				
G56632					20.74	13.59	7.15				
G56633					20.08	12.52	7.56				
G56634					20.08	12.52	7.56				
G56635					16.6	10.42	6.18				
G56636					16.6	10.42	6.18				
G56637					22.12	14.12	8				

\* Damping force, in pounds, to either extend or collapse the shock absorber at an average operating velocity. Fuerza de amortiguación en libras para extender o comprimir el amortiguador a una velocidad de operación promedio. La puissance d'amortissement en poids de l'amortisseur, soit comprimé, soit détendu, à une vitesse de fonctionnement moyenne.

## ESPECIFICACIONES POR NÚMERO DE PARTE

GRC	Montajes		Calibre de Pistón	Imagen de Diámetro Exterior	Longitudes [in]			Polvera	Tope Hidráulico	Fuerza*	
	Superior	Inferior			Extendido	Comprimido	Carrera			Rebote	Compresión
G56640					22.12	14.37	7.75				
G56641					22.12	14.37	7.75				
G56642					17.3	11.14	6.16				
G56643					17.3	11.14					
G56644					19.07	12.00	7.07				
G56645					19.07	12.00	7.07				
G56648					20.28	13.50	6.77				
G56649					20.63	13.98	6.65				
G56650					20.63	13.98	6.65				
G56655					20.03	13.38	6.65				
G56660					19.62	13.87	5.75				
G56661					19.62	13.87	5.75				
G56664					17.86	12.45	5.41				
G56667					20.81	13.23	7.58				
G56668					20.81	13.23	7.58				
G56669					17.65	10.57	7.09				
G56670					17.65	10.57	7.09				
G56671	B10				20.5	13.62	6.87				
G56672	B10				20.5	13.61	6.87				
G56673					18.89	11.48	7.41				
G56674					18.89	11.48	7.41				
G56675					20.95	12.25	8.7				
G56676					20.95	12.25	8.7				
G56677					19.87	13.37	6.5				
G56678					19.87	13.37	6.5				
G56679	B2				21.26	15.9	5.36				
G56680	B2				21.26	15.9	5.36				
G56681					23.3	15.26	8.04				
G56682					23.3	15.26	8.04				
G56683	B10				21.12	14.37	6.75				
G56684	B10				21.12	14.37	6.75				
G56685	B11				21.12	14.37	6.75				
G56686	B11				21.12	14.37	6.75				
G56687					22.56	15.98	6.58				
G56688					22.56	15.98	6.58				
G56689					19.12	13.12	6				
G56690					19.12	13.12	6				
G56691					22.5	14.75	7.75				
G56694					18.78	11.06	7.72				
G56700					17.19	10.57	6.62				
G56701					18.49	11.34	7.15				
G56703					17.90	10.85	7.05				
G56704					17.73	11.07	6.66				

\* Damping force, in pounds, to either extend or collapse the shock absorber at an average operating velocity. Fuerza de amortiguación en libras para extender o comprimir el amortiguador a una velocidad de operación promedio. La puissance d'amortissement en poids de l'amortisseur, soit comprimé, soit détendu, à une vitesse de fonctionnement moyenne.

## ESPECIFICACIONES POR NÚMERO DE PARTE

GRC	Montajes		Calibre de Pistón	Imagen de Diámetro Exterior	Longitudes [in]			Polvera	Tope Hidráulico	Fuerza*	
	Superior	Inferior			Extendido	Comprimido	Carrera			Rebote	Compresión
G56705					17.63	11.28	6.36				
G56706					17.63	11.28	6.36				
G56707					21.6	13.77	7.84				
G56708					18.77	10.85	7.92				
G56712					27.12	17.05	10.07				
G56713					18.01	10.76	7.25				
G56714					18.53	10.62	7.91				
G56715					17.84	9.98	7.87				
G56716					17.43	10.89	6.54				
G56717					17.9	10.86	7.05				
G56718					18.63	11.07	7.57				
G56719					20.04	13.26	6.78				
G56720					17.63	11.28	6.36				
G56721					18.91	11.48	7.43				
G56722					18.91	11.48	7.43				
G56723					17.63	11.28	6.36				
G56724					17.63	11.28	6.36				
G56728					20.95	12.25	8.7				
G56729					20.95	12.25	8.7				
G56730					23.72	16.95	6.77				
G56731					23.72	16.95	6.77				
G56732					22.91	15.41	7.50				
G56733					22.91	15.41	7.50				
G56734					24.31	17.32	6.99				
G56735					24.31	17.32	6.99				
G56736					23.31	16.65	6.66				
G56739					23.31	16.65	6.66				
G56740					16.56	10.41	6.15				
G56741					16.56	10.41	6.15				
G56742					19.17	12.36	6.81				
G56748					19.37	12.95	6.42				
G56749					18.82	12.76	6.06				
G56750					18.74	12.76	5.98				
G56751					18.74	12.76	5.98				
G56752					18.74	12.76	5.98				
G56753					18.74	12.76	5.98				
G56754					19.45	12.76	6.69				
G56755					19.45	12.76	6.69				
G56756					18.35	12.76	5.59				
G56757					14.7	9.34	5.36				
G56758	B17				21.75	14.50	7.25				
G56759					27.75	14.50	13.25				
G56760					21.5	17.00	4.5				

\* Damping force, in pounds, to either extend or collapse the shock absorber at an average operating velocity. Fuerza de amortiguación en libras para extender o comprimir el amortiguador a una velocidad de operación promedio. La puissance d'amortissement en poids de l'amortisseur, soit comprimé, soit détendu, à une vitesse de fonctionnement moyenne.

## ESPECIFICACIONES POR NÚMERO DE PARTE

GRC	Montajes		Calibre de Pistón	Imagen de Diámetro Exterior	Longitudes [in]			Polvera	Tope Hidráulico	Fuerza*	
	Superior	Inferior			Extendido	Comprimido	Carrera			Rebote	Compresión
G56761					21.5	17.00	4.5				
G56762	B9				20.5	14.00	6.5				
G56763					23.25	15.75	7.5				
G56764					23.25	15.75	7.5				
G56765					19.87	14.25	5.62				
G56766					19.87	14.25	5.62				
G56767	B9				21.75	14.37	7.37				
G56768	B9				21.75	14.37	7.37				
G56769					21.75	14.50	7.25				
G56770					22.25	17.12	5.12				
G56771					22.25	17.12	5.12				
G56772	B18				20.8	13.38	7.42				
G56773	B13				20.94	12.87	8.07				
G56774	B13				20.94	12.87	8.07				
G56775					16.98	9.9	7.08				
G56776					16.98	9.9	7.08				
G56778					21.37	14.37	7				
G56781					19.37	14.00	5.37				
G56782					19.37	14.00	5.37				
G56784					20.25	14.25	6				
G56785					20.25	14.25	6				
G56786					13.37	8.50	4.87				
G56787					13.37	8.50	4.87				
G56790	B7				18.5	12.87	5.62				
G56791					20.25	16.12	4.13				
G56792					19.5	16.12	3.38				
G56793					19.13	13	6.13				
G56794					19.13	13	6.13				
G56795	B11				20.62	14.75	5.87				
G56796					20.67	14.21	6.46				
G56797					23.82	16.54	7.28				
G56798					23.54	16.34	7.2				
G56799	B17				21.1	14.53	6.57				
G56800	B17				21.1	14.53	6.57				
G56801	B2				17.25	11.75	5.5				
G56802	B11				20.75	14.12	6.63				
G56803	B16				21.43	14.98	6.45				
G56805	B10				18.75	12.75	6.00				
G56806	B10				18.75	12.75	6.00				
G56807					21	14.25	6.75				
G56809					19.75	13.12	6.62				
G56810					20	13.50	6.5				
G56812					16.62	10.32	6.37				

\* Damping force, in pounds, to either extend or collapse the shock absorber at an average operating velocity. Fuerza de amortiguación en libras para extender o comprimir el amortiguador a una velocidad de operación promedio. La puissance d'amortissement en poids de l'amortisseur, soit comprimé, soit détendu, à une vitesse de fonctionnement moyenne.

## ESPECIFICACIONES POR NÚMERO DE PARTE

GRC	Montajes		Calibre de Pistón	Imagen de Diámetro Exterior	Longitudes [in]			Polvera	Tope Hidráulico	Fuerza*	
	Superior	Inferior			Extendido	Comprimido	Carrera			Rebote	Compresión
G56813					21.73	15.75	5.98				
G56814					21.73	15.75	5.98				
G56815					22	15.37	6.62				
G56816					22	15.37	6.62				
G56817					16.59	10.9	5.69				
G56819	B12				21.35	15.18	6.16				
G56820	B12				21.35	15.18	6.16				
G56821					23.27	15.90	7.36				
G56822					23.27	15.90	7.36				
G56836					18.84	13.12	5.72				
G56837					18.84	13.12	5.72				
G56838					21.06	17.99	3.07				
G56839					19.33	13.42	5.91				
G56840					20.51	13.63	6.88				
G56841					20.51	13.63	6.88				
G56842					19.47	13.41					
G56843					19.47	13.41					
G56882					20.44	13.69	6.75				
G56883					20.44	13.69	6.75				
G56884					22.34	14.9	7.44				
G56885					22.34	14.9	7.44				
G56886					20.09	13.79	6.30				
G56887					20.09	13.79	6.30				
G56888					21.38	14.49	6.89				
G56889					21.38	14.49	6.89				
G56890					20.47	13.31	7.16				
G56891					20.47	13.31	7.16				
G56892					17.87	12.24	5.63				
G56893					17.87	12.24	5.63				
G56894					20.98	14.29	6.69				
G56895					18.86	12.36	6.5				
G56896					18.86	12.36	6.5				
G56897					22.40	14.21	8.19				
G56899					21.1	14.8	6.30				
G56903					21.92	15.19	6.74				
G56978					17.72	11.02	6.69				
G56979					17.72	11.02	6.69				
G56983					19.21	12.60	6.61				
G56999					18.38	11.53	6.85				
G63173	EB1	EB1			21.86	13.58	8.28				
G63183	EB4	EB4			20.79	13.01	7.78				
G63187	S1	S1			22.92	13.39	9.53				
G63299	EB1	EB1			18.08	11.55	6.53				

\* Damping force, in pounds, to either extend or collapse the shock absorber at an average operating velocity. Fuerza de amortiguación en libras para extender o comprimir el amortiguador a una velocidad de operación promedio. La puissance d'amortissement en poids de l'amortisseur, soit comprimé, soit détendu, à une vitesse de fonctionnement moyenne.

## ESPECIFICACIONES POR NÚMERO DE PARTE

GRC	Montajes		Calibre de Pistón	Imagen de Diámetro Exterior	Longitudes [in]			Polvera	Tope Hidráulico	Fuerza*	
	Superior	Inferior			Extendido	Comprimido	Carrera			Rebote	Compresión
G63306	ES24	ES24			19.85	12.57	7.28				
G63347	ES31	ES35			18.08	11.55	6.53				
G63349	EB1	ES34			23.33	14.3	9.03				
G63350	S1	ES25			18.82	11.79	7.03				
G63353	ES27	EB4			24.74	14.96	9.78				
G63355	EB1	ES24			14.98	9.95	5.03				
G63357	ES24	ES24			14.98	9.95	5.03				
G63359	S1	BP13			13.7	8.92	4.78				
G63360	S1	BP13			15.7	9.92	5.78				
G63366	ES34	ES34			23.26	14.23	9.03				
G63371	ES24	ES24			21.98	13.45	8.53				
G63375	S12	BP7			14.14	9.11	5.03				
G63377	EB1	ES25			20.08	12.55	7.53				
G63386	S36	ES25			16.11	10.58	5.53				
G63387	S1	ES25			23.32	14.04	9.28				
G63389	ES27	EB4			28.74	16.96	11.78				
G63394	EB1	ES24			16.01	10.48	5.53				
G63396	S12	ES25			16.55	10.77	5.78				
G63398	S1	S1			20.42	12.14	8.28				
G63403	ES26	ES26			24.58	14.8	9.78				
G63404	S1	ES64			17.05	11.02	6.03				
G63405	EB1	EB1			20.01	12.48	7.53				
G63406	EB1	ES185			22.98	13.95	9.03				
G63409	EB1	ES185			21.48	13.2	8.28				
G63410	S12	EB1			18.55	11.77	6.78				
G63411	ES31	ES26			18.58	11.8	6.78				
G63413	ES27	ES27			20.76	12.98	7.78				
G63414	S36	ES41			15.09	10.06	5.03				
G63416	S12	ES185			18.55	11.77	6.78				
G63418	S1	BP11			13.95	9.17	4.78				
G63419	EB1	EB1			24.08	14.55	9.53				
G63420	EB1	ES106			27.08	16.05	11.03				
G63421	S1	BP30			13.7	8.92	4.78				
G63422	BP14	ES34			24.01	14.48	9.53				
G63423	ES26	ES26			16.76	10.73	6.03				
G63424	S1	BP7			20.45	12.67	7.78				
G63425	BP20	EB1			20.01	12.48	7.53				
G63426	ES18	ES18			18.01	11.48	6.53				
G63427	EB1	ES106			22.98	13.95	9.03				
G63432	S1	EB19			21.11	12.83	8.28				
G63434	EB19	S32			22.68	13.9	8.78				
G63437	ES31	ES24			23.33	14.05	9.28				
G63438	EB1	ES34			29.33	17.3	12.03				

\* Damping force, in pounds, to either extend or collapse the shock absorber at an average operating velocity. Fuerza de amortiguación en libras para extender o comprimir el amortiguador a una velocidad de operación promedio. La puissance d'amortissement en poids de l'amortisseur, soit comprimé, soit détendu, à une vitesse de fonctionnement moyenne.

## ESPECIFICACIONES POR NÚMERO DE PARTE

GRC	Montajes		Calibre de Pistón	Imagen de Diámetro Exterior	Longitudes [in]			Polvera	Tope Hidráulico	Fuerza*	
	Superior	Inferior			Extendido	Comprimido	Carrera			Rebote	Compresión
G63439	EB1	ES185			29.76	17.23	12.53				
G63440	EB1	EB1			26.33	15.55	10.78				
G63441	EB1	ES25			26.33	15.55	10.78				
G63443	EB1	EB1			23.33	13.95	9.38				
G63444	S1	ES64			23.3	14.02	9.28				
G63445	S36	ES185			23.09	14.06	9.03				
G63446	S12	EB1			23.3	14.02	9.28				
G63447	S12	ES25			30.18	17.65	12.53				
G63454	ES141	ES141			22.79	14.01	8.78				
G63455	ES41	ES41			22.98	13.95	9.03				
G63456	EB1	ES185			26.85	16.07	10.78				
G63457	S1	BP4			13.7	8.92	4.78				
G63460	BP13	ES27			23.16	14.13	9.03				
G63461	EB1	ES41			25.51	15.23	10.28				
G63479	S1	ES113			13.95	9.17	4.78				
G63484	S8	EB1			20.05	12.52	7.53				
G63488	BP14	ES34			26.61	16.33	10.28				
G63489	S29	BP11			14.42	9.64	4.78				
G63490	EB1	ES25			19.08	12.05	7.03				
G63491	EB1	S1			19.05	11.77	7.28				
G63492	EB1	EB1			22.58	13.8	8.78				
G63494	EB19	EB19			22.39	13.86	8.53				
G63495	S1	ES64			14.95	9.67	5.28				
G63499	BP13	ES26			25.58	15.3	10.28				
G63500	S36	ES25			15.09	10.06	5.03				
G63502	ES25	ES141			18.51	11.98	6.53				
G63506	S32	S32			21.4	12.64	8.76				
G63510	EB19	EB19			21.29	13.26	8.03				
G63511	S1	ES25			22.45	13.42	9.03				
G63524	EB1	ES185			27.08	16.05	11.03				
G63525	EB1	ES185			22.98	13.95	9.03				
G63547	S1	ES113			13.61	9.08	4.53				
G63548	S12	EB19			21.11	13.08	8.03				
G63603	S36	ES185			16.12	10.59	5.53				
G63604	EB1	ES142			19.74	12.46	7.28				
G63605	EB19	ES27			24.24	14.71	9.53				
G63606	ES152	ES153			21.29	13.51	7.78				
G63607	BP14	ES185			25.58	15.3	10.28				
G63608	S36	EB1			14.56	9.78	4.78				
G63609	ES126	ES128			16.5	10.97	5.53				
G63610	S47	EB1			21.95	13.17	8.78				
G63611	S1	ES64			14.95	9.67	5.28				
G63612	S1	ES64			14.45	9.67	4.78				

\* Damping force, in pounds, to either extend or collapse the shock absorber at an average operating velocity. Fuerza de amortiguación en libras para extender o comprimir el amortiguador a una velocidad de operación promedio. La puissance d'amortissement en poids de l'amortisseur, soit comprimé, soit détendu, à une vitesse de fonctionnement moyenne.

## ESPECIFICACIONES POR NÚMERO DE PARTE

GRC	Montajes		Calibre de Pistón	Imagen de Diámetro Exterior	Longitudes [in]			Polvera	Tope Hidráulico	Fuerza*	
	Superior	Inferior			Extendido	Comprimido	Carrera			Rebote	Compresión
G63614	S36	EB1			15.09	10.06	5.03				
G63615	S38	S38			23.66	13.88	9.78				
G63616	S38	EB19			23.78	14.25	9.53				
G63617	ES83	EB1			27.58	16.3	11.28				
G63620	EB1	S17			19.55	12.27	7.28				
G63621	S12	BP7			16.46	10.93	5.53				
G63622	S36	EB1			15.32	10.29	5.03				
G63623	S36	ES185			22.57	14.29	8.28				
G63624	S36	ES185			20.17	12.64	7.53				
G63625	EB1	ES24			22.56	13.78	8.78				
G63626	EB5	ES24			21.14	13.36	7.78				
G63635	S1	ES69			14.45	9.42	5.03				
G63638	BP14	ES34			24.33	14.8	9.53				
G63639	EB19	ES69			24.16	14.63	9.53				
G63640	ES152	ES153			23.89	15.11	8.78				
G63660	EB1	EB1			25.08	15.05	10.03				
G63661	S38	ES34			13.8	9.52	4.28				
G63662	ES34	ES34			24.58	15.05	9.53				
G63671	ES26	ES26			22.48	13.7	8.78				
G63673	S38	ES34			22.3	13.77	8.53				
G63674	S38	ES34			23.39	14.36	9.03				
G63675	ES34	ES34			26.86	16.08	10.78				
G63676	ES69	ES69			15.48	10.45	5.03				
G63678	S36	BP7			18.09	13.56	4.53				
G63679	BP14	ES185			25.01	14.98	10.03				
G63683	EB5	ES24			21.14	13.36	7.78				
G63689	EB1	EB1			19.08	12.05	7.03				
G63690	ES18	ES18			18.01	11.48	6.53				
G63692	EB1	EB1			27.58	16.3	11.28				
G63694	S38	EB20			22.18	13.4	8.78				
G63707	S12	ES64			15.89	10.11	5.78				
G63708	ES48	EB19			19.74	12.46	7.28				
G63710	S1	ES153			18.96	11.93	7.03				
G63712	ES110	ES19			22.48	13.7	8.78				
G63714	S62	BP7			15.39	9.86	5.53				
G63715	S12	ES171			28.55	16.52	12.03				
G63716	S62	ES26			16.39	9.86	6.53				
G63717	ES41	ES41			22.98	13.95	9.03				
G63720	S36	ES22			21.39	12.86	8.53				
G63721	S12	BP11			20.21	12.43	7.78				
G63722	BP20	ES24			19.49	12.21	7.28				
G63726	S12	EB19			21.05	12.77	8.28				
G63772	S36	BP10			13.73	9.45	4.28				

\* Damping force, in pounds, to either extend or collapse the shock absorber at an average operating velocity. Fuerza de amortiguación en libras para extender o comprimir el amortiguador a una velocidad de operación promedio. La puissance d'amortissement en poids de l'amortisseur, soit comprimé, soit détendu, à une vitesse de fonctionnement moyenne.



## ESPECIFICACIONES POR NÚMERO DE PARTE

GRC	Montajes		Calibre de Pistón	Imagen de Diámetro Exterior	Longitudes [in]			Polvera	Tope Hidráulico	Fuerza*	
	Superior	Inferior			Extendido	Comprimido	Carrera			Rebote	Compresión
G63773	EB1	ES185			22.98	13.95	9.03				
G63775	EB1	ES185			27.08	16.05	11.03				
G63776	ES185	ES185			20.76	12.98	7.78				
G63778	S12	ES171			24.55	14.52	10.03				
G63781	S1	ES113			18.45	11.93	6.52				
G63782	S1	ES118			13.7	9.09	4.61				
G63783	S12	BP11			14.59	10.21	4.38				
G63798	S1	EB1			15.98	10.2	5.78				
G63799	S1	ES185			18.55	11.77	6.78				
G63803	S12	Horquilla			15.36	10.33	5.03				
G63808	EB1	ES185			28.86	17.08	11.78				
G63809	EB1	ES185			22.98	13.95	9.03				
G63810	EB1	ES185			31.6	18.57	13.03				
G63811	EB1	ES41			25.51	15.23	10.28				
G63812	ES86	ES36			22.56	13.78	8.78				
G63813	S47	ES64			12.23	8.45	3.78				
G63815	S47	ES64			21.95	13.17	8.78				
G63817	S12	ES60			15.8	11.02	4.78				
G63818	ES126	ES128			16.51	10.98	5.53				
G63828	S21	EB20			23.16	15.13	8.03				
G63829	ES88	ES65			22.52	13.74	8.78				
G63832	S21	ES153			17.16	11.38	5.78				
G63837	BP8	ES41			28.23	17.95	10.28				
G63841					16.58	11.05	5.5				
G63842	ES18	ES126			23.33	14.8	8.53				
G63844	ES87	ES19			22.52	13.74	8.78				
G63845	ES87	ES19			24.58	14.8	9.78				
G63847	S1	BP7			20.45	12.67	7.78				
G63848	S38	ES34			15.87	10.59	5.28				
G63860	S1	EB1			24.33	14.39	9.94				
G63862	S1	ES67			25.07	14.94	10.13				
G63864	ES67	ES61			15	10.56	4.44				
G63866	ES34	ES34			22.81	14.12	8.69				
G63867	ES82	ES82			27.31	16.37	10.94				
G63868	ES164	ES68			15.61	10.67	4.94				
G63869	ES41	ES41			20.26	12.82	7.44				
G63870	ES82	ES82			24.89	15.2	9.69				
G63872	ES128	ES128			21.65	13.29	8.36				
G63873	ES82	ES82			15.75	10.56	5.19				
G63875	ES13	ES13			17.67	11.73	5.94				
G63877	ES69	ES69			16.93	11.24	5.69				
G63878	ES34	ES13			24.16	14.97	9.19				
G63879	BP10	ES34			23	14.31	8.69				

\* Damping force, in pounds, to either extend or collapse the shock absorber at an average operating velocity. Fuerza de amortiguación en libras para extender o comprimir el amortiguador a una velocidad de operación promedio. La puissance d'amortissement en poids de l'amortisseur, soit comprimé, soit détendu, à une vitesse de fonctionnement moyenne.

## ESPECIFICACIONES POR NÚMERO DE PARTE

GRC	Montajes		Calibre de Pistón	Imagen de Diámetro Exterior	Longitudes [in]			Polvera	Tope Hidráulico	Fuerza*	
	Superior	Inferior			Extendido	Comprimido	Carrera			Rebote	Compresión
G63880	BP18	ES18			22.5	14.06	8.44				
G63881	S1	ES25			14.71	9.49	5.22				
G63882	BP10	ES34			21	13.31	7.69				
G63883	ES34	ES13			22.82	14.38	8.44				
G63884	S47	EB13			14.72	9.78	4.94				
G63885	S59	ES36			22.24	13.56	8.68				
G63886	S38	ES34			20.8	13.36	7.44				
G63887	EB1	ES41			29.71	17.77	11.94				
G63888	EB1	ES41			31.36	18.67	12.69				
G63889	S1	ES81			20.44	12.75	7.69				
G63890	ES87	ES87			23.97	15.28	8.69				
G63891	ES87	ES87			23.97	15.28	8.69				
G63892	ES19	ES87			23.97	15.28	8.69				
G63893	S11	Horquilla			15.07	10.44	4.63				
G63894	S11	BP9			12.82	8.88	3.94				
G63895	S11	BP9			14.12	9.68	4.44				
G63896	BP14	ES34			22.36	13.92	8.44				
G63897	BP14	ES34			23.87	14.68	9.19				
G63898	BP14	ES34			25.19	15.31	9.88				
G63900	S1	BP4			14.1	9.34	4.76				
G63902	S1	ES64			12.6	8.59	4.01				
G63903	S1	BP14			14.7	9.34	5.36				
G63904	S1	ES64			14.95	9.95	5.00				
G63905	S1	ES76			14.7	9.34	5.36				
G63906	ES27	ES27			20.49	12.63	7.86				
G63907	EB1	EB1			20.23	12.37	7.86				
G63908	ES31	ES24			18.23	11.37	6.86				
G63909	S1	ES64			14.11	9	5.11				
G63914	S29	ES84			21.12	16.31	4.81				
G63915	S1	BP7			13.2	8.59	4.61				
G63918	ES34	ES141			21.25	13.56	7.69				
G63919	ES58	ES153			21.25	13.56	7.69				
G63928	EB1	EB1			22.73	13.87	8.86				
G63929	S36	EB1			14.72	9.71	5.01				
G63937	S1	BP19			14.7	9.34	5.36				
G63949	EB1	EB1			17.73	11.12	6.61				
G63950	S1	BP7			14.2	9.09	5.11				
G63958	S29	BP13			13.8	9.13	4.67				
G63959	ES34	ES34			24.78	15.84	8.94				
G63961	ES34	ES34			26.51	16.12	10.39				
G63962	ES34	ES34			26.05	15.87	10.18				
G63963	EB1	ES185			24.75	15.06	9.69				
G63964	EB1	ES185			25.48	15.53	9.95				

\* Damping force, in pounds, to either extend or collapse the shock absorber at an average operating velocity. Fuerza de amortiguación en libras para extender o comprimir el amortiguador a una velocidad de operación promedio. La puissance d'amortissement en poids de l'amortisseur, soit comprimé, doit détendu, à une vitesse de fonctionnement moyenne.

## ESPECIFICACIONES POR NÚMERO DE PARTE

GRC	Montajes		Calibre de Pistón	Imagen de Diámetro Exterior	Longitudes [in]			Polvera	Tope Hidráulico	Fuerza*	
	Superior	Inferior			Extendido	Comprimido	Carrera			Rebote	Compresión
G63965	BP14	ES34			24.14	15.2	8.94				
G63966	BP18	ES26			22.45	14.5	7.95				
G63967	BP18	ES26			22.62	14.43	8.19				
G63969	S62	ES34			20.75	13.31	7.44				
G63970	ES34	ES34			27.58	17.14	10.44				
G63971	ES34	ES34			27.58	17.14	10.44				
G64000	ES34	ES34			27.36	17.68	9.68				
G64001	S11	Horquilla			14.67	11.47	3.20				
G64002	ES83	ES83			20.15	13.96	6.19				
G64003	ES69	ES69			16.84	11.28	5.56				
G64004	S1	ES81			19.07	12.13	6.94				
G64005	S1	ES81			19.75	12.31	7.44				
G64006	S1	ES81			22.75	13.81	8.94				
G64007	S1	ES81			22.75	13.81	8.94				
G64008	S57	ES26			21.79	13.6	8.19				
G64009	S38	ES34			23.29	14.25	9.04				
G64010	EB1	ES83			26.94	16	10.94				
G64011	S62	ES87			23.36	14.21	9.15				
G64012	ES88	ES69			24.11	15.17	8.94				
G64013	ES34	ES34			26.52	16.33	10.19				
G64014	ES47	ES45			22.75	14.56	8.19				
G64015	ES45	ES128			21.32	13.63	7.69				
G64016	ES19	ES17			15.91	11.22	4.69				
G64026	ES73	ES73			16.26	11.57	4.69				
G64027	S47	ES118			13.62	8.74	4.88				
G64028	EB16	ES113			20.75	13.19	7.56				
G64029	S38	ES36			21.73	13.54	8.19				
G64030	S38	ES36			22.56	13.86	8.70				
G64031	ES34	EB1			21.19	13.5	7.69				
G64032	ES49	ES49			18.7	12.09	6.61				
G64033	ES51	ES51			14.72	10.36	4.36				
G64036	S45	ES51			22.67	13.66	9.01				
G64037	S55	ES147			26.37	15.47	10.9				
G64038	S63	ES69			24.48	15.07	9.41				
G64040	ES42	ES50			15.9	11.1	4.8				
G64042	ES18	ES18			14.92	10.55	4.37				
G64043	S61				14.09	9.68	4.41				
G64044	ES49	ES49			25.98	16.22	9.76				
G64046	S65	ES93			18.62	14.72	3.9				
G64047					25.03	15	10.03				
G64048	ES75	ES113			17.16	11.57	5.59				
G64049	S51	ES55			14.96	11.65	3.31				
G64050	ES30	ES137			19.55	12.91	6.65				

\* Damping force, in pounds, to either extend or collapse the shock absorber at an average operating velocity. Fuerza de amortiguación en libras para extender o comprimir el amortiguador a una velocidad de operación promedio. La puissance d'amortissement en poids de l'amortisseur, soit comprimé, soit détendu, à une vitesse de fonctionnement moyenne.

## ESPECIFICACIONES POR NÚMERO DE PARTE

GRC	Montajes		Calibre de Pistón	Imagen de Diámetro Exterior	Longitudes [in]			Polvera	Tope Hidráulico	Fuerza*	
	Superior	Inferior			Extendido	Comprimido	Carrera			Rebote	Compresión
G64052	ES83	ES83			20.86	13.11	7.75				
G64056	S18	ES83			20.51	13.11	7.4				
G64079	ES83	ES83			29.37	17.32	12.05				
G64080	ES69	ES33			21.57	17.72	3.85				
G64087					22.63	13.78	8.85				

\* Damping force, in pounds, to either extend or collapse the shock absorber at an average operating velocity. Fuerza de amortiguación en libras para extender o comprimir el amortiguador a una velocidad de operación promedio. La puissance d'amortissement en poids de l'amortisseur, soit comprimé, soit détendu, à une vitesse de fonctionnement moyenne.

## KITS DE ACCESORIOS Y COMPONENTES

<b>140126</b>	401383	2	Seguro (arandela)	3/8" D.I. x 1-1/2" D.E. x .093" espesor
	402263	2	Buje	orificio de centrado de 7/8" para espiga con D.E. 3/8"
	401006	1	Tuerca hexagonal	3/8" x 24 UNF cuerda
<b>140149</b>	401011	4	Buje	Estilo EB2 - para anillo con D.E. 1-3/4" - Espiga de 3/4" diam.
<b>140169</b>	401011	2	Buje	Estilo EB2 - para anillo con D.E. 1-3/4" - Espiga de 3/4" diam.
<b>140357</b>	401193	1	Arandela de seguridad	D.I. 5/8" (delgada)
	403050	1	Perno	1/2" x 20 and 5/8" x 18 cuerda
	401266	1	Seguro (arandela)	5/8" D.I. x 1-1/4" D.E. x .075" espesor
	401174	1	Tuerca hexagonal	5/8" x 18 cuerda
	401166	1	Arandela de seguridad	1/2" Arandela de seguridad
	401164	1	Tuerca hexagonal	1/2" x 20 UNF cuerda
402519	1	Seguro (arandela)	1/2" D.I. x 1-1/4" D.E. x .104" espesor	
<b>140455</b>	401006	1	Tuerca hexagonal	3/8" x 24 UNF cuerda
	401008	2	Seguro (arandela)	3/8" D.I. x 1-1/4" D.E. x .075" espesor
	403489	2	Buje	orificio de centrado de 5/8" para espiga con D.E. 3/8"
<b>140524</b>	401006	1	Tuerca hexagonal	3/8" x 24 UNF cuerda
	401376	2	Seguro (arandela)	3/8" D.I. x 1-3/8" D.E. x .089" espesor
	402294	2	Buje	orificio de centrado de 5/8" para espiga con dia. 3/8" - orificios de 5/8" o 7/8"
<b>140526</b>	403813	2	Bota	
	403815	2	Chaveta	
	404046	2	Tuerca	1/2" x 20 UNF cuerda
<b>140673</b>	401006	1	Tuerca hexagonal	3/8" x 24 UNF cuerda
	401008	2	Seguro (arandela)	3/8" D.I. x 1-1/4" D.E. x .075" espesor
	403962	2	Buje	orificio de centrado de 1/2" para espiga con D.E. 3/8"
<b>140689</b>	401006	3	Tuerca hexagonal	3/8" x 24 UNF cuerda
	402263	2	Buje	orificio de centrado de 7/8" para espiga con D.E. 3/8"
	404001	2	Seguro (arandela)	10 mm D.I. x 1-1/2" D.E. x .120" espesor
<b>140702</b>	401174	1	Tuerca hexagonal	5/8" x 18 cuerda
	404782	1	Perno	5/8" x 18 and 7/16" x 20
	403878	1	Arandela	0.453" D.I. x 1.25" D.E. x .075" espesor
	402844	1	Tuerca hexagonal	7/16" x 20 UNF cuerda
	401184	1	Arandela de seguridad	7/16" Arandela de seguridad
	401193	1	Arandela de seguridad	D.I. 5/8" (delgada)
<b>140719</b>	402653-001	2	Arandela de seguridad	D.I. 5/16" (med.)
	403870-001	2	Tornillo	Cabeza Hexagonal de 5/16" x 18 x 3/4" largo
	403871-001	2	Tuerca hexagonal	5/16" x 18 cuerda
<b>140780</b>	403299	2	Buje	orificio de centrado de 7/8" para espiga con D.E. 7/16"
	403298	1	Seguro (arandela)	0.390" D.I. x 1.68" D.E. x .120" espesor
	402943	1	Seguro (arandela)	0.457" D.I. x 1.68" D.E. x .120" espesor
	401006	1	Tuerca hexagonal	3/8" x 24 UNF cuerda

## KITS DE ACCESORIOS Y COMPONENTES

<b>140857</b>	401008	1	Seguro (arandela)	3/8" D.I. x 1-1/4" D.E. x .075" espesor
	401383	1	Seguro (arandela)	3/8" D.I. x 1-1/2" D.E. x .093" espesor
	403489	2	Buje	orificio de centrado de 5/8" para espiga con D.E. 3/8"
	429680-030	1	Hoja de instr.	
	401006	1	Tuerca hexagonal	3/8" x 24 UNF cuerda
<b>140884</b>	412016	1	Tuerca ext.	7/16" x 20 UNF cuerda
	427030	1	Hoja de instr.	
	402662	1	Espaciador	5/8" D.I. x 1-1/4" D.E. x 1/4" espesor
	401267	1	Seguro (arandela)	5/8" D.I. x 1-1/4" D.E. x .075" espesor
<b>140885</b>	402662	1	Espaciador	5/8" D.I. x 1-1/4" D.E. x 1/4" espesor
	403189	2	Espaciador	1/2" D.I. x 1-1/4" D.E. x .250" espesor
	411012	2	Camisa	13 mm D.I. x 5/8 in. D.E. x 1-5/16 in. largo
	412016	1	Tuerca ext.	7/16" x 20 UNF cuerda
	427031	1	Hoja de instr.	
	401267	1	Seguro (arandela)	5/8" D.I. x 1-1/4" D.E. x .075" espesor
<b>140921</b>	401011	2	Buje	Estilo EB2 - para anillo con D.E. 1-3/4" - Espiga de 3/4" diam.
	401377	1	Seguro (arandela)	1/2" D.I. x 1-3/8" D.E. x .075" espesor
	402267	2	Buje	orificio de centrado de 9/16" para espiga con D.E. 7/16"
	401007	1	Tuerca de cierre	3/8" x 24 UNF cuerda
	401006	1	Tuerca hexagonal	3/8" x 24 UNF cuerda
	401383	1	Seguro (arandela)	3/8" D.I. x 1-1/2" D.E. x .093" espesor
<b>140947</b>	401193	1	Arandela de seguridad	D.I. 5/8" (delgada)
	404451	2	Tuerca hexagonal	16 x 1.5 cuerda métrica
	404452	4	Seguro (arandela)	5/8" D.I. x 2-3/4" D.E. x .180" espesor
	404453	2	Camisa	16 mm D.I. x 1-3/16" D.E. x 1-1/2" largo
	404454	4	Buje	orificio de centrado de 1-3/16" para espiga con D.E. 13/16"
<b>141041</b>	401376	2	Seguro (arandela)	3/8" D.I. x 1-3/8" D.E. x .089" espesor
	404652	2	Buje	Usado con orificio de 5/8" o 7/8" de diámetro
	401006	1	Tuerca hexagonal	3/8" x 24 UNF cuerda
<b>141045</b>	401377	1	Seguro (arandela)	1/2" D.I. x 1-3/8" D.E. x .075" espesor
	401383	1	Seguro (arandela)	3/8" D.I. x 1-1/2" D.E. x .093" espesor
	402284	2	Buje	orificio de centrado de 5/8" para espiga con D.E. 3/8"
	401006	1	Tuerca hexagonal	3/8" x 24 UNF cuerda
<b>141047</b>	403877	1	Perno	1/2" x 20 and 7/16" x 20
	402943	1	Seguro (arandela)	0.457" D.I. x 1.68" D.E. x .120" espesor
	403878	1	Arandela	0.453" D.I. x 1.25" D.E. x .075" espesor
	403299	2	Buje	orificio de centrado de 7/8" para espiga con D.E. 7/16"
	403298	1	Seguro (arandela)	0.390" D.I. x 1.68" D.E. x .120" espesor
	401184	1	Arandela de seguridad	7/16" Arandela de seguridad
	401166	1	Arandela de seguridad	1/2" Arandela de seguridad
	401006	1	Tuerca hexagonal	3/8" x 24 UNF cuerda
	401164	1	Tuerca hexagonal	1/2" x 20 UNF cuerda
	402844	1	Tuerca hexagonal	7/16" x 20 UNF cuerda

## KITS DE ACCESORIOS Y COMPONENTES

<b>141083</b>	404454	2	Buje	orificio de centrado de 1-3/16" para espiga con D.E. 13/16"
	401193	1	Arandela de seguridad	D.I. 5/8" (delgada)
	404451	1	Tuerca hexagonal	16 x 1.5 metric cuerda
	404452	2	Seguro (arandela)	5/8" D.I. x 2-3/4" D.E. x .180" espesor
	404453	1	Camisa	16 mm D.I. x 1-3/16" D.E. x 1-1/2" largo
<b>141108</b>	405361-000	4	Buje	orificio de centrado de 1" para espiga con D.E. 5/8" (espesor 1.00")
	401174	2	Tuerca hexagonal	5/8" x 18 cuerda
	405360	4	Seguro (arandela)	5/8" D.I. x 2-3/16" D.E. x .120" espesor
<b>141137</b>	402812	1	Camisa	13 mm D.I. x 5/8 in. D.E. x 1-5/16 in. largo
<b>141138</b>	401006	2	Tuerca hexagonal	3/8" x 24 UNF cuerda
	403489	4	Buje	orificio de centrado de 5/8" para espiga con D.E. 3/8"
	403575	4	Seguro (arandela)	25/64" D.I. x 1-1/4" D.E. x .12" espesor
	404949	4	Arandela	1/2" D.I. x 1-1/2" D.E. x .04" espesor
<b>141168</b>	404985	1	Buje	orificio de centrado de 5/8" para espiga con D.E. 3/8"
	429680-015	1	Hoja de instr.	
	404350	1	Seguro (arandela)	3/8" D.I. x 1-5/8" D.E. x .119" espesor
	401008	1	Seguro (arandela)	3/8" D.I. x 1-1/4" D.E. x .075" espesor
	401006	1	Tuerca hexagonal	3/8" x 24 UNF cuerda
	404986	1	Buje	orificio de centrado de 5/8" para espiga con D.E. 3/8"
<b>141247</b>	401174	1	Tuerca hexagonal	5/8" x 18 cuerda
	401754	2	Buje	Estilo EB3 para anillo con D.E. 2.39" - Espiga de 1" diam.
	405360	2	Seguro (arandela)	5/8" D.I. x 2-3/16" D.E. x .120" espesor
	405361-000	2	Buje	orificio de centrado de 1" para espiga con D.E. 5/8" (espesor 1.00")
<b>141349</b>	404652	2	Buje	Usado con orificio de 5/8" o 7/8" de diámetro
	429680-030	1	Hoja de instr.	
	401376	2	Seguro (arandela)	3/8" D.I. x 1-3/8" D.E. x .089" espesor
	401007	1	Tuerca de cierre	3/8" x 24 UNF cuerda
	401006	1	Tuerca hexagonal	3/8" x 24 UNF cuerda
<b>141350</b>	401376	2	Seguro (arandela)	3/8" D.I. x 1-3/8" D.E. x .089" espesor
	402294	2	Buje	orificio de centrado de 5/8" para espiga con dia. 3/8" - orificios de 5/8" o 7/8"
	411520	1	Contratuerca	3/8" x 24 UNF cuerda
	401006	1	Tuerca hexagonal	3/8" x 24 UNF cuerda
<b>141353</b>	401006	1	Tuerca hexagonal	3/8" x 24 UNF cuerda
	401007	1	Contratuerca	3/8" x 24 UNF cuerda
	401383	2	Seguro (arandela)	3/8" D.I. x 1-1/2" D.E. x .093" espesor
	402263	2	Buje	orificio de centrado de 7/8" para espiga con D.E. 3/8"
<b>141354</b>	401007	1	Tuerca de cierre	3/8" x 24 UNF cuerda
	404959	2	Buje	orificio de centrado de 3/4" para espiga con D.E. 7/16"
	401006	1	Tuerca hexagonal	3/8" x 24 UNF cuerda
	404485	1	Seguro (arandela)	0.453" D.I. x 1.63" D.E. x 0.120" espesor
	404350	1	Seguro (arandela)	3/8" D.I. x 1-5/8" D.E. x .119" espesor

## KITS DE ACCESORIOS Y COMPONENTES

<b>141356</b>	401006	1	Tuerca hexagonal	3/8" x 24 UNF cuerda
	401007	1	Tuerca de cierre	3/8" x 24 UNF cuerda
	401008	2	Seguro (arandela)	3/8" D.I. x 1-1/4" D.E. x .075" espesor
	403962	2	Buje	orificio de centrado de 1/2" para espiga con D.E. 3/8"
<b>141368</b>	401007	1	Contratuerca	3/8" x 24 UNF cuerda
	429680-030	1	Hoja de instr.	
	403489	2	Buje	orificio de centrado de 5/8" para espiga con D.E. 3/8"
	401008	1	Seguro (arandela)	3/8" D.I. x 1-1/4" D.E. x .075" espesor
	401006	1	Tuerca hexagonal	3/8" x 24 UNF cuerda
	401383	1	Seguro (arandela)	3/8" D.I. x 1-1/2" D.E. x .093" espesor
<b>141376</b>	401006	1	Tuerca hexagonal	3/8" x 24 UNF cuerda
	401007	1	Tuerca de cierre	3/8" x 24 UNF cuerda
	401008	2	Seguro (arandela)	3/8" D.I. x 1-1/4" D.E. x .075" espesor
	403489	2	Buje	orificio de centrado de 5/8" para espiga con D.E. 3/8"
<b>141439</b>	411446	2	Seguro (arandela)	3/4" D.I. x 1 7/8" D.E. x .047" espesor
	411447	1	Seguro (arandela)	9/16" D.I. x 1-3/4" D.E. x .087" espesor
	411165	1	Contratuerca	12 x 1.25 cuerda métrica
	401011	2	Buje	Estilo EB2 - para anillo con D.E. 1-3/4" - Espiga de 3/4" diam.
	412554	1	Seguro (arandela)	0.485" D.E x 1.76" D.E. x .089" espesor
	411445	2	Buje	Buje plano para Espiga con D.E. 9/16"
<b>141448</b>	404715	1	Espaciador	0.737" D.I x 1.75" D.E. x .120 espesor
	411165	1	Contratuerca	12 x 1.25 cuerda métrica
	411445	2	Buje	Buje plano para Espiga con D.E. 9/16"
	411446	1	Seguro (arandela)	3/4" D.I. x 1 7/8" D.E. x .047" espesor
	411447	1	Arandela	9/16" D.I. x 1-3/4" D.E. x .087" espesor
	412554	1	Seguro (arandela)	0.485" D.E x 1.76" D.E. x .089" espesor
<b>141514</b>	401007	1	Tuerca de cierre	3/8" x 24 UNF cuerda
	401383	2	Seguro (arandela)	3/8" D.I. x 1-1/2" D.E. x .093" espesor
	401006	1	Tuerca hexagonal	3/8" x 24 UNF cuerda
	404947	2	Buje	3/8" D.I. x 1-3/16" x 9/16" espesor
<b>141537</b>	401006	1	Tuerca hexagonal	3/8" x 24 UNF cuerda
	404350	2	Seguro (arandela)	3/8" D.I. x 1-5/8" D.E. x .119" espesor
	404985	2	Buje	orificio de centrado de 5/8" para espiga con D.E. 3/8"
<b>141665</b>	401006	1	Tuerca hexagonal	3/8" x 24 UNF cuerda
	402943	1	Seguro (arandela)	0.457" D.I. x 1.68" D.E. x .120" espesor
	403298	1	Seguro (arandela)	0.390" D.I. x 1.68" D.E. x .120" espesor
	404959	2	Buje	orificio de centrado de 3/4" para espiga con D.E. 7/16"
	411520	1	Contratuerca	3/8" x 24 UNF cuerda
<b>142036</b>	411497	1	Contratuerca	10 x 1.25 cuerda métrica



## KITS DE ACCESORIOS Y COMPONENTES

<b>142069</b>	411447	2	Arandela	9/16" D.I. x 1-3/4" D.E. x .087" espesor
	412103	2	Seguro (arandela)	9/16" D.I. x 1-3/4" D.E. x 1/4" espesor
	412116	4	Buje	Buje plano para Espiga con D.E. 9/16"
	412554	2	Seguro (arandela)	0.485" D.E x 1.76" D.E. x .089" espesor
	411165	2	Contratuerca	12 x 1.25 cuerda métrica
<b>142095</b>	411165	1	Contratuerca	12 x 1.25 cuerda métrica
	411447	2	Seguro (arandela)	9/16" D.I. x 1-3/4" D.E. x .087" espesor
	412103	1	Seguro (arandela)	9/16" D.I. x 1-3/4" D.E. x 1/4" espesor
	412116	2	Buje	Buje plano para Espiga con D.E. 9/16"
<b>142280</b>	411672	1	Seguro (arandela)	0.410" D.I. x 2.05" D.E. x 0.175" espesor
	412046	1	Contratuerca	10 x 1.5 cuerda métrica
	411633	2	Buje	orificio de centrado de 0.810" para espiga con D.E. 7/16"
	412479	1	Seguro (arandela)	0.490" D.I. x 2.15" D.E. x 0.180" espesor
<b>142389</b>	404287	2	Seguro (arandela)	0.453" D.I x 1.50" D.E x 0.090" espesor
	404947	2	Buje	Para espiga con D.E. 3/8" - sin orificio de centrado
	411497	1	Contratuerca	10 x 1.25 cuerda métrica
<b>142592</b>	402539	2	Tornillo	5/16" x 24 UNF cuerda x 1" largo
	402573	2	Tuerca	5/16" x 24 UNF cuerda
	402653	2	Arandela de seguridad	Contratuerca de 5/16"
	411385	2	Seguro (arandela)	0.355" D.I x 0.74" D.E. x 0.075" espesor
<b>142615</b>	401376	1	Seguro (arandela)	3/8" D.I. x 1-3/8" D.E. x .089" espesor
	402943	1	Seguro (arandela)	0.457" D.I. x 1.68" D.E. x .120" espesor
	401006	1	Tuerca hexagonal	3/8" x 24 UNF cuerda
	404652	2	Buje	Usado con orificio de 5/8" o 7/8" de diámetro
<b>142617</b>	401006	1	Tuerca hexagonal	3/8" x 24 UNF cuerda
	402943	1	Seguro (arandela)	0.457" D.I. x 1.68" D.E. x .120" espesor
	403298	1	Seguro (arandela)	0.390" D.I. x 1.68" D.E. x .120" espesor
	412661	2	Buje	orificio de centrado de 0.790" para espiga con D.E. 7/16"
<b>142656</b>	412116	2	Buje	Buje plano para Espiga con D.E. 9/16"
	412554	1	Seguro (arandela)	0.485" D.E x 1.76" D.E. x .089" espesor
	412103	1	Seguro (arandela)	9/16" D.I. x 1-3/4" D.E. x 1/4" espesor
	411447	1	Seguro (arandela)	9/16" D.I. x 1-3/4" D.E. x .087" espesor
	411446	1	Seguro (arandela)	3/4" D.I. x 1 7/8" D.E. x .047" espesor
	411165	1	Contratuerca	12 x 1.25 cuerda métrica
<b>142657</b>	411446	2	Seguro (arandela)	3/4" D.I. x 1 7/8" D.E. x .047" espesor
	411447	2	Seguro (arandela)	9/16" D.I. x 1-3/4" D.E. x .087" espesor
	412103	2	Seguro (arandela)	9/16" D.I. x 1-3/4" D.E. x 1/4" espesor
	412116	4	Buje	Buje plano para Espiga con D.E. 9/16"
	412554	2	Seguro (arandela)	0.485" D.E x 1.76" D.E. x .089" espesor
	411165	2	Contratuerca	12 x 1.25 cuerda métrica

## KITS DE ACCESORIOS Y COMPONENTES

<b>142700</b>	402943	1	Seguro (arandela)	0.457" D.I. x 1.68" D.E. x .120" espesor
	429680-008	1	Hoja de instr.	
	412682	1	Camisa	0.479" D.I. x 0.548" D.E. x 1.48" largo
	411520	1	Contratuerca	3/8" x 24 UNF cuerda
	404959	2	Buje	orificio de centrado de 3/4" para espiga con D.E. 7/16"
	401006	1	Tuerca hexagonal	3/8" x 24 UNF cuerda
	403298	1	Seguro (arandela)	0.390" D.I. x 1.68" D.E. x .120" espesor
<b>142731</b>	411165	1	Contratuerca	12 x 1.25 cuerda métrica
	411447	1	Seguro (arandela)	9/16" D.I. x 1-3/4" D.E. x .087" espesor
	412554	1	Seguro (arandela)	0.485" D.E x 1.76" D.E. x .089" espesor
	412675	2	Buje	orificio de centrado de 0.950" para espiga con D.E. 9/16"
<b>142973</b>	412479	1	Seguro (arandela)	0.490" D.I. x 2.15" D.E. x 0.180" espesor
	411633	2	Buje	orificio de centrado de 0.810" para espiga con D.E. 7/16"
	411672	1	Seguro (arandela)	0.410" D.I. x 2.05" D.E. x 0.175" espesor
	412046	1	Contratuerca	10 x 1.5 cuerda métrica
<b>142976</b>	429680-031	1	Hoja de instr.	
	405361-000	2	Buje	orificio de centrado de 1" para espiga con D.E. 5/8" (espesor 1.00")
	401174	1	Tuerca hexagonal	5/8" x 18 cuerda
	405360	2	Seguro (arandela)	5/8" D.I. x 2-3/16" D.E. x .120" espesor
<b>142998</b>	404452	2	Seguro (arandela)	5/8" D.I. x 2-3/4" D.E. x .180" espesor
	404454	2	Buje	orificio de centrado de 1-3/16" para espiga con D.E. 13/16"
	405862	1	Tuerca de seguridad	5/8" x 18 cuerda
	412872	1	Camisa	0.643" D.I. x .815" D.E. x 1.44" largo
<b>143000</b>	412116	2	Buje	Buje plano para Espiga con D.E. 9/16"
	412554	1	Seguro (arandela)	0.485" D.E x 1.76" D.E. x .089" espesor
	429680-033	1	Hoja de instr.	
	411165	1	Contratuerca	12 x 1.25 cuerda métrica
	404695	1	Seguro (arandela)	0.709" orificio de centrado x 1.97" D.E. x .060" espesor
	411447	1	Seguro (arandela)	9/16" D.I. x 1-3/4" D.E. x .087" espesor
	404715	1	Espaciador	0.737" D.I x 1.75" D.E. x .120 espesor
<b>143078</b>	412675	2	Buje	orificio de centrado de 0.950" para espiga con D.E. 9/16"
	401006	1	Tuerca hexagonal	3/8" x 24 UNF cuerda
	404969	1	Camisa	0.400" D.I. x .620" D.E. x 1.48" largo
	412554	2	Seguro (arandela)	0.485" D.E x 1.76" D.E. x .089" espesor
<b>143146</b>	412675	2	Buje	orificio de centrado de 0.950" para espiga con D.E. 9/16"
	411165	1	Contratuerca	12 x 1.25 cuerda métrica
	411447	2	Seguro (arandela)	9/16" D.I. x 1-3/4" D.E. x .087" espesor
<b>145054</b>	401174	1	Tuerca hexagonal	5/8" x 18 cuerda
	401175	1	Arandela de seguridad	5/8" Arandela de seguridad
	405360	2	Seguro (arandela)	5/8" D.I. x 2-3/16" D.E. x .120" espesor
	405361-000	2	Buje	orificio de centrado de 1" para espiga con D.E. 5/8" (espesor 1.00")

## KITS DE ACCESORIOS Y COMPONENTES

<b>145075</b>	401752	1	Seguro (arandela)	1" D.I. x 2-3/8" D.E. x .105" espesor
	405361-000	2	Buje	orificio de centrado de 1" para espiga con D.E. 5/8" (espesor 1.00")
	405360	2	Seguro (arandela)	5/8" D.I. x 2-3/16" D.E. x .120" espesor
	401750	1	Seguro (arandela)	3/4" D.I. x 2-3/8" D.E. x .105" espesor
	401754	2	Buje	Estilo EB3 para anillo con D.E. 2.39" - Espiga de 1" diam.
<b>145080</b>	401011	2	Buje	Estilo EB2 - para anillo con D.E. 1-3/4" - Espiga de 3/4" diam.
	401429	1	Seguro (arandela)	1/2" D.I. x 1-5/8" D.E. x .090" espesor
	401430	1	Seguro (arandela)	3/4" D.I. x 1-5/8" D.E. x .090" espesor
<b>145089-000</b>	405862	1	Tuerca de seguridad	5/8" x 18 cuerda
	405360	2	Seguro (arandela)	5/8" D.I. x 2-3/16" D.E. x .120" espesor
	405361-000	2	Buje	orificio de centrado de 1" para espiga con D.E. 5/8" (espesor 1.00")
<b>145089-200</b>	415196-001	1	Contratuerca	5/8" x 18 cuerda
	405360	2	Seguro (arandela)	5/8" D.I. x 2-3/16" D.E. x .120" espesor
	405361-100	2	Buje	orificio de centrado de 1" para espiga con D.E. 5/8" (espesor 0.75")
<b>145090</b>	424276	1	Hoja de instr.	
	405643	1	Camisa	0.645" D.I x 0.810" D.E. x 2.00" largo
	405859	2	Buje	0.815" D.I. x 2.35" D.E. x 1.05" espesor con orificio de centrado de 1.15"
	405860	2	Seguro (arandela)	0.650" D.I. x 2.75" D.E. x .180" espesor
	405862	1	Tuerca de seguridad	5/8" x 18 cuerda
<b>145093</b>	401754	4	Buje	Anillo con D.E. 2.39" - Espiga de 1" diam.
	401752	2	Seguro (arandela)	1" D.I. x 2-3/8" D.E. x .105" espesor
	401750	2	Seguro (arandela)	3/4" D.I. x 2-3/8" D.E. x .105" espesor
<b>145099</b>	401175	1	Arandela de seguridad	5/8" Arandela de seguridad
	401754	2	Buje	Estilo EB3 para anillo con D.E. 2.39" - Espiga de 1" diam.
	405360	2	Seguro (arandela)	5/8" D.I. x 2-3/16" D.E. x .120" espesor
	405361-000	2	Buje	orificio de centrado de 1" para espiga con D.E. 5/8" (espesor 1.00")
	424274	1	Hoja de instr.	
	401174	1	Tuerca hexagonal	5/8" x 18 cuerda
<b>145112</b>	405360	1	Seguro (arandela)	5/8" D.I. x 2-3/16" D.E. x .120" espesor
	405361-000	2	Buje	orificio de centrado de 1" para espiga con D.E. 5/8" (espesor 1.00")
	401165	1	Arandela de seguridad	1/2" Arandela de seguridad
	401164	1	Tuerca hexagonal	1/2" x 20 UNF cuerda
	405934	1	Seguro (arandela)	0.530" D.I. x 2-3/16" D.E. x .120" espesor
<b>145116</b>	401750	1	Seguro (arandela)	3/4" D.I. x 2-3/8" D.E. x .105" espesor
	401752	1	Seguro (arandela)	1" D.I. x 2-3/8" D.E. x .105" espesor
	415169	2	Buje (Durometer 80)	Estilo EB3 para anillo con D.E. 2.39" - Espiga de 1" diam.
<b>145123</b>	405360	2	Seguro (arandela)	5/8" D.I. x 2-3/16" D.E. x .120" espesor
	405862	1	Tuerca de seguridad	5/8" x 18 cuerda
	415017-001	2	Buje	orificio de centrado de 1" para espiga con D.E. 5/8"

## KITS DE ACCESORIOS Y COMPONENTES

<b>145126</b>	415277	1	Espaciador	1-3/16" D.I. x 1-1/4" D.E. x .200" espesor
	424281	1	Hoja de instr.	
	401754	2	Buje	Estilo EB3 para anillo con D.E. 2.39" - Espiga de 1" diam.
	401750	2	Seguro (arandela)	3/4" D.I. x 2-3/8" D.E. x .105" espesor
	403752	1	Camisa	3/4" D.I. x 15/16" D.E. x 1-3/4" largo
<b>145128</b>	405360	2	Seguro (arandela)	5/8" D.I. x 2-3/16" D.E. x .120" espesor
	405361-000	2	Buje	orificio de centrado de 1" para espiga con D.E. 5/8" (espesor 1.00")
	415196-001	1	Contratuerca	5/8" x 18 cuerda
<b>145132</b>	415305-000	2	Espaciador de goma	0.910" D.I. x 1.58" D.E. x 1.1" largo
	415305-001	2	Espaciador de goma	0.910" D.I. x 1.58" D.E. x 0.427" largo
	424282	1	Hoja de instr.	
<b>145140</b>	405360	2	Seguro (arandela)	5/8" D.I. x 2-3/16" D.E. x .120" espesor
	405862	1	Tuerca de seguridad	5/8" x 18 cuerda
	415326-001	2	Buje de uretano	orificio de centrado de 1" para espiga con D.E. 5/8"
<b>145143</b>	415305-001	2	Espaciador de goma	0.910" D.I. x 1.58" D.E. x 0.427" largo
	424284	1	Hoja de instr.	
<b>145144</b>	415305-000	2	Espaciador de goma	0.910" D.I. x 1.58" D.E. x 1.1" largo
	424284	1	Hoja de instr.	
<b>145147</b>	401429	1	Seguro (arandela)	1/2" D.I. x 1-5/8" D.E. x .090" espesor
	401430	1	Seguro (arandela)	3/4" D.I. x 1-5/8" D.E. x .090" espesor
<b>145148</b>	401750	1	Seguro (arandela)	3/4" D.I. x 2-3/8" D.E. x .105" espesor
	401752	1	Seguro (arandela)	1" D.I. x 2-3/8" D.E. x .105" espesor
<b>145149</b>	401265	1	Seguro (arandela)	1/2" D.I. x 1-1/4" D.E. x .075" espesor
	401266	1	Seguro (arandela)	5/8" D.I. x 1-1/4" D.E. x .075" espesor
<b>145168</b>	424276	1	Hoja de instr.	
	405862	1	Tuerca de seguridad	5/8" x 18 cuerda
	405860	2	Seguro (arandela)	0.650" D.I. x 2.75" D.E. x .180" espesor
	405859-100	2	Buje	0.815" D.I. x 2.35" D.E. x 0.800" espesor con orificio de centrado de 1.15"
	405643-100	1	Camisa	0.645" D.I. x 0.810" D.E. x 1.50" largo
<b>145177</b>	424296	1	Hoja de instr.	
	415010-802	1	Camisa	22 mm D.I. x 1.00" D.E. x 1-3/4" largo
	401754	2	Buje	Estilo EB3 para anillo con D.E. 2.39" - Espiga de 1" diam.
	406422	2	Seguro (arandela)	22 mm D.I. x 60.2 mm D.E. x 2.7 mm espesor
<b>401011</b>		1	Buje	Estilo EB2 - para anillo con D.E. 1-3/4" - Espiga de 3/4" diam.
<b>401754</b>		1	Buje	Estilo EB3 para anillo con D.E. 2.39" - Espiga de 1" diam.
<b>404702</b>		1	Buje	Estilo EB1 - 1 pz buje carrete (D.I. 5/8")

## KITS DE ACCESORIOS Y COMPONENTES

<b>405360</b>	1 Seguro (arandela)	5/8" D.I. x 2-3/16" D.E. x .120" espesor
<b>405361-000</b>	1 Buje	orificio de centrado de 1" para espiga con D.E. 5/8" (espesor 1.00")
<b>406422</b>	1 Seguro (arandela)	22 mm D.I. x 60.2 mm D.E. x 2.7 mm espesor
<b>415010-802</b>	1 Camisa	22 mm D.I. x 1.00" D.E. x 1-3/4" largo
<b>415015-001</b>	1 Buje de uretano	Estilo EB3 para anillo con D.E. 2.39" - Espiga de 1" diam.
<b>415017</b>	1 Buje de uretano	orificio de centrado de 1" para espiga con D.E. 5/8" (reemplazado por 415326-001)
<b>415025-001</b>	1 Buje de uretano	Estilo EB2 - para anillo con D.E. 1-3/4" - Espiga de 3/4" diam.
<b>415326-001</b>	1 Buje de uretano	orificio de centrado de 1" para espiga con D.E. 5/8"
<b>TR0027</b>	1 Buje	Estilo EB2 - para anillo con D.E. 1-3/4" - Espiga de 3/4" diam. - (Reemplaza 401011)

## KITS DE ACCESORIOS – GUÍA DEL COMPRADOR

Kit #	GRC #
<b>140126</b>	83027
<b>140149</b>	83200
	83216
	83219
	83308
	83309
	83312
	83314
	85023
	85024
	85046
	85047
	89401
	89402
	89403
	89409
	89415
	89416
	89434
	89435
<b>140169</b>	85025
	85031
<b>140455</b>	83003
	83005
	83014
	83015
	83400
<b>140524</b>	83161
	83507
<b>140702</b>	83303
	83304
<b>140780</b>	83018
	83019
	83041
	83045
	83050
	83058
	83105
	83114
	83162
	83177
<b>141041</b>	83509
	83513
	83514
	83515
<b>141083</b>	83301
	83317

Kit #	GRC #
<b>141083 Cont</b>	83318
	83613
<b>141108</b>	85310
	89423
	89447
	89455
<b>141247</b>	85311
	85312
	85703
	85710
	85711
	89424
<b>141387</b>	85107
<b>142095</b>	83178
<b>142491</b>	85101
<b>142656</b>	83512
<b>142998</b>	83456
<b>145054</b>	83103
	83134
	83136
	83635
	85009
	85025
	85026
	85027
	85071
	85080
	85085
	85092
	85096
	85318
	85324
	85330
	85336
	85342
	85379
	85701
	85729
	85731
	85900
	85902
	85921
	89417
	89418
	89441
<b>145075</b>	85723
<b>145080</b>	83107

Kit #	GRC #
<b>145080 Cont</b>	85012
	85054
	85055
	85062
	85063
	89408
	89413
	89438
	89439
<b>145090</b>	85081
	85093
	85103
	85110
	85117
	85123
	85316
	85346
	85347
	85380
	85705
	85706
	85707
	85708
	85709
	85722
	85740
	85745
	85746
	85935
	85973
	85982
	85987
	85993
	87016
	87020
	89426
	695406
<b>145093</b>	85714
	85715
	85716
	85717
	85718
	85719
<b>145099</b>	83353
	85033
	85988
	89427

## KITS DE ACCESORIOS – GUÍA DEL COMPRADOR

Kit #	GRC #	
<b>145116</b>	83162	
	85732	
	87016	
<b>145126</b>	85053	
	89442	
<b>145128</b>	83062	
	83109	
	83110	
	83111	
	83112	
	83138	
	83142	
	83143	
	85065	
	85083	
	85332	
	85333	
	85977	
	<b>145140</b>	85727
		85728
<b>145143</b>	83120	
<b>145144</b>	85065	
<b>145148</b>	83140	
	83141	
<b>145168</b>	83173	
	85981	
<b>145177</b>	85118	
<b>401011</b>	83179	
	83404	
	83505	
	83506	
<b>401754</b>	83214	
	83215	
	83217	
	83225	
	83362	
	85001	
	85004	
	85007	
	85040	
	85042	
	85070	
	85300	
	85301	
	85302	
	85303	
	85304	

Kit #	GRC #
<b>401754 Cont</b>	85305
	85307
	85308
	85313
	85314
	85315
	85320
	85322
	85327
	85329
	85334
	85339
	85343
	85376
	85380
	85700
	85702
	85703
	85704
	85710
	85711
	85712
85713	
85720	
85729	
85730	
85731	
85734	
85735	
85736	
85740	
85901	
85905	
85912	
85913	
85940	
85941	
85942	
85943	
85944	
85948	
85949	
85951	
85968	
85983	
89410	
89412	

Kit #	GRC #
<b>401754 Cont</b>	89419
	89420
	89422
	89425
	89429
	89459
<b>404702</b>	83001
	83006
	83007
	83011
	83012
	83038
	83047
	83117
	83161
	83177
	83401
83508	
83509	
83510	
<b>405360</b>	85727
<b>406422</b>	83162
<b>145089-000</b>	83102
	83120
	83154
	85069
	85073
	85122
	85319
	85340
	85341
	85343
85733	
85970	
89428	
<b>145089-200</b>	85936
	85937
	85985
	89456
<b>145168-000</b>	85996
	85997
<b>415010-802</b>	83140
	83141
	83162
<b>415015-001</b>	85987
<b>TR0027</b>	83159
	83511

## KITS DE ACCESORIOS – GUÍA DEL COMPRADOR

<b>Kit #</b>	<b>GRC #</b>
<b>TR0027 Cont</b>	83512
	83513
	83514
	83515
	85031
	85074
	85077
	89446



# GRC® - CONSEJOS DE SOPORTE TÉCNICO



## GRC® - Consejos de Soporte Técnico

Consulte estos consejos antes de reemplazar los amortiguadores

### Realice la prueba de calor

Si experimenta deterioro en la conducción y se sospecha que un amortiguador tiene fallas internas, realice la siguiente "PRUEBA DE CALOR DEL AMORTIGUADOR" unos minutos después de operar el equipo.

Los amortiguadores operan a temperaturas que oscilan desde la temperatura ambiente hasta los 177 °C. Los amortiguadores reducen la oscilación de los resortes al transformar en calor, la energía producida por estos. Como resultado, el amortiguador debe estar un poco caliente al tacto después de su uso normal.

1. Conduzca el vehículo a velocidades moderadas durante al menos 15 minutos.
2. Todos los amortiguadores deben estar más calientes que el chasis. Dentro de los siguientes minutos de conducir el vehículo, toque una parte cercana del chasis para establecer una temperatura ambiente de referencia, y posteriormente toque cada amortiguador con cuidado por debajo de la polvera. Note si algún amortiguador no está caliente.
3. Sospeche de una falla en cualquier amortiguador que esté notablemente más frío que su par en el otro extremo del eje.  
Una temperatura distintas de eje a eje no significa que haya una falla, pero las temperaturas más bajas en cualquier eje sí justifica la remoción e inspección del amortiguador más frío.
4. Para inspeccionar, remueva y agite el amortiguador sospechoso. Un sonido de traqueteo de partes metálicas en el interior puede indicar una falla interna.



# SOPORTE TÉCNICO

**¿DUDAS? CONSULTE A LOS EXPERTOS**

**01 800 12 27 846 | [www.grcautopartes.com.mx](http://www.grcautopartes.com.mx)**



Con el **SOPORTE TÉCNICO GRC**, usted nunca recibirá mensajes grabados, solamente respuestas de nuestros expertos. Si tiene alguna pregunta para nuestro equipo de Soporte Técnico, llame sin costo o visite el sitio web [www.grcautopartes.com.mx](http://www.grcautopartes.com.mx) y consulte las preguntas frecuentes, artículos, boletines técnicos y videos detallados y obtener las respuestas que necesita para hacer el trabajo correctamente.

# GRC<sup>®</sup>

## AMORTIGUADORES Y STRUTS

**Distribuidor Autorizado:**

GRC Centro de Promociones y Asistencia  
Técnica Comercial  
**01 800 12 27 846**  
[Servicio.Clientesgrcautopartes@gabriel.com](mailto:Servicio.Clientesgrcautopartes@gabriel.com)

Atención al Cliente y Oficina Comercial  
**442 278 12 00**  
**Ext. 1259, 1262, 1297**  
Lunes - Viernes 8:30 am - 6:00 pm.

Visita nuestra página WEB: [www.grcautopartes.com.mx](http://www.grcautopartes.com.mx)

Ride Control Mexicana, S. de R.L. de C.V.

Av. El Tepeyac 1770 Parque Industrial El Tepeyac, El Marques, Querétaro, C.P. 76250.

Esta guía rápida puede ser usada únicamente para especificar y vender productos de Ride Control Mexicana, sus subsidiarios y sus compañías afiliadas. Si se usa para especificar o vender otros productos es una violación de los derechos de autor. El presente catálogo ha sido elaborado con gran cuidado habiéndose verificado la exactitud de los datos en él contenidos, sin embargo, Ride Control Mexicana no se hace responsable por posibles datos erróneos o incompletos.

